



# GIMA

## INTERNATIONAL CATALOGUE PROFESSIONAL MEDICAL PRODUCTS

# 2023

## PREVIEW



DIAGNOSTIC TESTS  
LABORATORY

OPERATOR'S PROTECTION

HOLLOWARE - SURGICAL  
INSTRUMENTS - SYRINGES

MEDICAL BAGS

SCALES & MEASURES

HEALTH CARE  
PATIENT AIDS

FURNITURE

PHYSIOTHERAPY  
NEBULIZERS - SUCTION PUMPS

GYNAECOLOGY  
& PROCTOLOGY

CAUTERY & ELECTROSURGERY

LOUPES, VISION  
& ENDOSCOPY

MEDICAL LIGHTS

DIAGNOSTICS

AUDIOMETRY  
& RESPIRATORY

ECG, MONITORS  
& ULTRASOUND

FIRST AID  
PARAMEDICAL - EMERGENCY

STERILIZATION

VETERINARY

HUMAN ANATOMY  
MODELS



EVOLVE STETHOSCOPES

page 280



MULTIFUNCTIONAL TROLLEYS

page 158

Dear Dealer,  
 Welcome to the new **GIMA INTERNATIONAL CATALOGUE 2023**,  
 your one-stop shopping source for over 9,500 sales opportunities  
 to offer to your customers.

Gima catalogue is designed to make it easier for you to find,  
 choose and buy your medical consumables and equipment.  
 Our customers throughout 145 countries know that they can  
 count on **GIMA** for ten reasons:

- ✓ **Quick delivery**  
*over 97% of products in stock ready for immediate delivery*
- ✓ **Quality products at competitive prices**  
*every product carefully selected and checked by our experts  
 to offer the best value for money*
- ✓ **On going research**  
*for the most innovative and advanced devices*
- ✓ **Careful attention**  
*order progress monitored at every stage*
- ✓ **Flexible response**  
*from small quantities to large volume orders*
- ✓ **Complete service**  
*full commitment to support before, during and after sales*
- ✓ **Four language service**  
*we speak English, on parle Français, parliamo Italiano,  
 hablamos Español*
- ✓ *All products provided with English manual, most with multilingual manual*
- ✓ **Easy ordering and no minimum order**  
*a simple e-mail with your requirements is all we need*
- ✓ **Personalizations**  
*Made-to-order products and packaging with your marks*
- ✓ **MDR Conformity in progress**

The best way to benefit from **GIMA** advantages is to try us.  
 Contact us today to establish a long term relationship.

Your sincerely

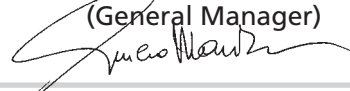
Dr. Giulio Manzoni  
 (General Manager)  



GIMA S.p.A. - Via Marconi, 1  
 20060 Gessate (MI) - Italy  
**E-mail: [export@gimaitaly.com](mailto:export@gimaitaly.com)**  
**[www.gimaitaly.com](http://www.gimaitaly.com)**

## 1926 - 2023: 97 YEARS OF EXPERIENCE

AREA	CONTACTS	E-MAIL
European Community - West	Lucia	lucia@gimaitaly.com
European Community - South, America	Letizia	letizia@gimaitaly.com
European Community - North and East	Sabrina	sabrina@gimaitaly.com
Eastern Europe, Middle-East	Cristiano	cristiano@gimaitaly.com
Africa	Mariagrazia	mariagrazia@gimaitaly.com
Arabian Gulf, Oceania	Arianna	arianna@gimaitaly.com
Asia	Roberta	roberta@gimaitaly.com

## OUR BRANDS



# OVER 1,000 NEW PRODUCTS!

**GIMA SAFETY LANCETS**



page 3

**FLUORESC. IMMUNOASSAY ANALYZER**



page 4

**SARS-COV-2 ANTIGEN TEST KIT**



page 10

**URINE SCREEN VISUAL STRIPS**



page 11

**GIMA PROTECTIVE SHIELD**

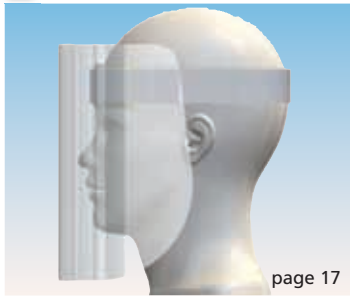

page 17

**3 PLY SURGICAL MASKS**



page 21-22

**FFP2, FFP3 FILTERING MASKS**



page 23-26

**GLOVES**



page 27-29

**INSULATION COVERALLS**



page 32

**SNEAKERS**



page 36

**FUNNY CAPS**

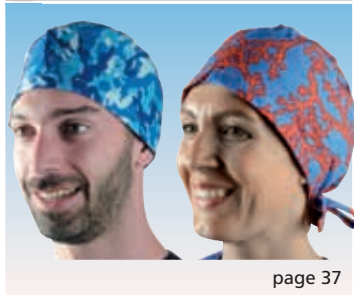

page 37

**PEHA® INSTRUMENTS - STERILE**



page 49

**SURGICAL SKIN MARKERS**



page 54

**SUTURE TRAINING KIT**



page 55

**DISPOSABLE SKIN STAPLER**



page 59

**GIMA CURETTES AND PUNCHES**

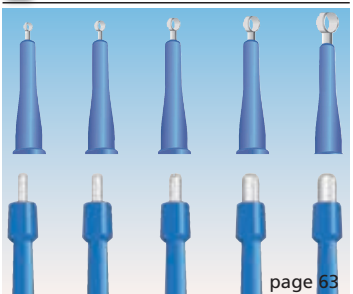

page 63

**MILITARY TOURNIQUETS**



page 75

**MULTIUSE BAGS**



page 79

**MULTIUSE SOFT CASE**



page 79

**ACTIVITY HEALTH TRACKERS**



page 91

**OMRON VIVA SCALE**



OMRON

page 92

**GIMA NON CONTACT THERMOMETERS**



page 99

**PILL CRUSHING DEVICE**



page 105

**PILL DISPENSER - BLUETOOTH**

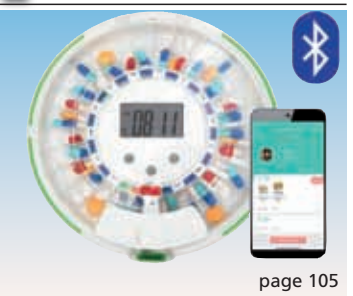

page 105

# OVER 1,000 NEW PRODUCTS!

CLIPUP® TOILET RAISER



page 115

COMMODE AND SHOWER CHAIR



page 116

PRINCE ROLLATOR



page 121

ALTERNATING PRESSURE MATTRESS



page 127

ELECTRIC ALUMINIUM PATIENT LIFTER



page 129

LIFT ARMCHAIRS



page 130

BABY CRADLES



page 133

HEIGHT ADJUSTABLE BED-3 CRANKS



page 136

HEIGHT ADJUSTABLE PATIENT TROLLEY



page 143

OPERATING TABLE



page 144

CLEAN LINEN TROLLEYS



page 154

STAINLESS STEEL EMERGENCY CARTS



page 156

SABA ELECTRIC CHAIR



page 168

HEIGHT ADJUSTABLE ELECTRIC TABLE



page 169

HEATING PADS

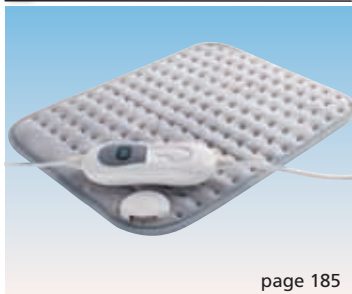

page 185

MAG 3000 MAGNETOTHERAPY



page 192

GIMA TENS/EMS/MASSAGE



page 193

BREAST PUMP



page 197

SUPERVEGA 118 ASPIRATOR



page 203

PREGNANCY TESTS

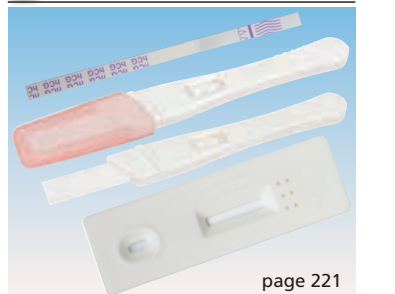

page 221

DIATERMO MB 300 T AND 400 T



page 228

CRYOMEGA® - CRYOCLEAR® DEVICES



page 237

GIMALED 200 K LIGHT SOURCE



page 239

2 LED HEADBAND MAGNIFIER



page 240

# OVER 1,000 NEW PRODUCTS!

■ QUATTROLUCI LED LIGHTS



page 245

■ ALFA-FLEX TROLLEY



page 248

■ SIGMA-C LED OTOSCOPE



page 258

■ 5 IN 1 HEALTH MONITOR



page 288

■ CHECKME™ LITE



page 289

■ RIESTER RBP-100 B.P.M.



page 293

■ OMRON M7 INTELLI IT



page 295

■ D-HEART ECG



page 324

■ NEO TABLET ECG WITH PRINTER



page 328

■ AMBU WHITE SENSOR ELECTRODES



page 334

■ Z50 MINDRAY ULTRASOUND



page 340

■ K12-15 MULTIPARAMETER MONITOR



page 347

■ RIESTER RVS-100 VITAL SIGNS MONITOR



page 348

■ RESCUE LIFE 9 MANUAL AED DEFIBRILLATOR



page 362

■ LAERDAL LITTLE FAMILY



page 364

■ RESPIRA OXYGEN CONCENTRATOR



page 368

■ DOCTORS KIT



page 385

■ PULSEOXIMETERS



page 389 - 391

■ O2 RING PULSEOXIMETER



page 392

■ LAERDAL STIFNECK SELECT COLLARS



page 393

■ SURGICAL ADHESIVE DRESSINGS



page 413

■ TEGADERM™ CHG DRESSING

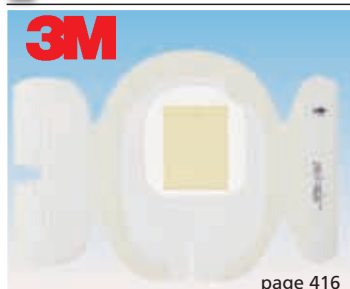

page 416

■ HYDROGEN PEROXIDE





















page 419

■ BARRICIDAL DISINFECTANT



page 421

# INDEX

	DIAGNOSTIC TESTS - LABORATORY	1-16		LOUPES, VISION & ENDOSCOPY	238-242
	OPERATOR'S PROTECTION	17-37		MEDICAL LIGHTS	243-251
	HOLLOWARE - SURGICAL INSTRUMENTS - SYRINGES	38-76		DIAGNOSTICS	252-310
	MEDICAL BAGS	77-84		AUDIOMETRY & RESPIRATORY	311-321
	SCALES & MEASURES	85-96		ECG, MONITORS & ULTRASOUND	322-352
	HEALTH CARE - PATIENT AIDS	97-128		FIRST AID - PARAMEDICAL - EMERGENCY	353-416
	FURNITURE	129-184		STERILIZATION	417-437
	PHYSIOTHERAPY - NEBULIZERS - SUCTION PUMPS	185-208		VETERINARY	438-448
	GYNAECOLOGY & PROCTOLOGY	209-222		HUMAN ANATOMY - MODELS	449-454
	CAUTERY & ELECTROSURGERY	223-237			

<b>A</b>	ABBOT glucose strips	3
	ABPM monitors	293
	Activity and health trackers	91
	Aerosols - nebulizers and accessories	198-200
	Aids for daily living	105-106, 126
	Air cleaner	423
	Air compression therapy	187
	Airways, Guedel	372, 385
	Alcohol pads, swabsticks and skin disinfectant	419
	Alcohol testers	14
	AMBU - collars	394
	- laryngeal mask	373
	- resuscitators	371-372
	- training manikins	363
	- videolaryngoscope	375
	- white and blue sensor electrodes	334
	Amniocentesis needles	210
	Amnioscope	216
	ANALYTICON Urilyzer 100 Pro and strips	12
	Anatomy models	449-454
	Anoscopes, proctoscopes	216
	Antibacterial films	424
	Anti-decubitus mattresses, cushions	127-128
	Anti-handling suit	110
	Armchairs	130
	Arm sling	393
	Aspirators - suction pumps	201-208
	Audiometers and booths	311-315
	Autoclaves	429-430
	Ayre spatulae	219

<b>B</b>	B-BRAUN irrigation solutions	414
	Backrest	134
	Bag holder trolleys	153
	Bags - leather, leatherette, cordura	77-84
	BALLET electrolysis needles	231
	Bandages	107, 404-407
	Basket stretcher	400
	Bathroom aids	113-116
	Batteries	265
	BD - needles, syringes, IV catheters, waste containers	71-73
	Bed pads	109
	Bed pans - plastic, stainless steel	65-66, 68
	Beds	135-138
	Beds for children	133
	Bed side rail pad	135
	Bedside tables	131-132
	Belts for commode, armchair, wheelchair and bed	126
	Belts for foetal monitor	212
	Belts for stretchers and boards	398
	Berkeley curettes	220
	Bibs	108, 110
	Bins	179
	Biopsy punches	63-64
	Bipolar forceps, cables	233-234
	Blades - laryngoscope	375-379
	Blankets	380
	Blood pressure monitors	288-298
	B.M.I. tape measure	86
	Body bags	396
	Body fat analyzers and scales	91-94
	Boel audiology test	311
	Bracelet I.D.	214
	Breast pump	197
	Brushes - cleaning	420
	Brushes - gynaecology	219

	BSN - tapes, bandages	404-409, 412
	Bulbs - nebulizers	198
	Bulbs - oto/ophthalmo/laryngoscopes	256
	Bulbs and accessories for sphygmomanometers	305-306
	Burn care products	380
<b>C</b>	Cabinets for drugs, medicines and instruments	152, 178
	Cabinets for defibrillators	354
	Cable for ECG	330, 335
	Cables for electrosurgery	231, 233
	Cameras	238, 251-255
	Canes	117-118
	Capillaroscope	251
	Capnography	386
	Caps - disposable	32
	- cotton	37
	Cardiac marker test	8
	Cardiotocograph	211
	Carts	146-162, 235
	Cases - emergency	84
	- for stethoscopes	275
	Catheters, lubricant and accessories	51-52
	Cautery	236
	Centrifuges	15
	Chairs	179, 182
	Chairs - bathroom/shower	113-116
	Chairs - gynaecology, ENT, podology	163-168
	Changing mat for babies	132-133
	CHISON ultrasound	341-343
	Chlorexidina disinfectants	420
	Cholesterol monitor and strips	5-6
	Cleaning solutions	110, 417-418
	Clippers	60, 107
	Clogs	35-36
	Clothes (coats, trousers)	31, 33-34
	CO <sub>2</sub> Respironics sensors	350
	Cohesive bandages	404-405
	Collars	393-394
	Collectors, biological	65
	Colposcope, videocolposcope	209-210
	Combiscreen® urine strips	12
	Commode	114-116
	Condoms	107
	Conductive cream	188
	Cot	396
	Cotton wool, rolls, gauzes	107, 401-403
	Couches	169-176
	Couches rolls	173
	Coveralls - insulation	32
	Covers for mattress	134
	COVID-19 tests - antibody, antigen, saliva	8-9
	CPAP devices and mask	315-316
	CPR mask	385
	Cradle	133
	Crutches	119
	Cryo surgical devices	237, 445
	Cuffs - sphygmomanometers	305-306
	Curettes Berkeley-Karman	220
	Curettes - dermal	63-64
	Curettes - ear	268
	Curtains	139, 177
	Cushions	128
	Cutlery set	106
	Cutters	41, 47
	Cylinders	369
	Cytology spray and accessories	220

- D**
- Defibrillators, pads and papers 353-362
  - Dental hygiene 97, 107, 418
  - Dental instruments 48
  - Dermatoscope 251-253
  - Desks 179-180
  - Diagnostic sets 257-264
  - Diagnostic tests 1-14
  - Diapason 272
  - Diathermy and accessories 223-235
  - Dining table 131
  - Disinfection instruments and environment 421-423
  - Disinfection skin 417-420
  - Distiller - water 426
  - Doctor's cabinet 179-180
  - Donor chairs 165
  - Dopplers: - foetal 213
  - vascular 338
  - Drapes 39
  - Dressing - bandages 107, 401-416
  - Dressing kits 45, 53
  - Drugs cabinets and trolleys 151-152, 155
  - Drug tests 13
  - Drums 431
  - Durapore™ 412
  - Dynamometer 90
- E**
- Ear curettes, ear speculum 265-266, 268
  - Ear irrigation system 267-268
  - Ear plugs 107
  - ECG and accessories 322-335
  - ECG workstation 322
  - Ecographs, ecolour Dopplers 339-344
  - EEG paste 337
  - Electrodepilator and accessories 231
  - Electrodes and adapters for ECG 332-334
  - Electrodes for electrosurgery 228-230
  - Electrodes for electrotherapy 193
  - Electrosurgery units and accessories 223-235
  - Electrotherapy units 190
  - Emergency bags, rucksacks, cases, kits 81-83, 381-385
  - Endometrial cannulas 220
  - Endoscopy 238-239
  - Endotracheal tubes 374
  - Enema irrigator 212
  - ENT chairs and cabinets 166
  - ENT head mirrors 240
  - ENT illumination and kit 268-269
  - ENT stainless steel instruments 46
  - ERKA - sphygmomanometers 299, 309
  - stethoscopes 282
  - ETHICON sutures 58
  - Exercise bands, tubings, mats, bike 125, 195-196
  - Extraction kits 396
  - Eye wash system 385
- F**
- Face masks - emergency and anesthesia 370
  - protection 19-26
  - Faeces containers 65
  - Fibre optics - cables/adaptors 239
  - Filters for aspirators 201-207
  - Filters for spirometers 317
  - Finger cots 30
  - Fire blankets 380
  - First aid cases/bags/rucksacs empty 81-84
  - First aid cases/bags/rucksacs filled 381-385
  - Flowmeters 369
  - Foetal monitors 211
  - Foley catheters 51
  - Foot stools 180
  - Forceps - instruments 38, 41, 43-46, 48-50, 53
  - Forceps - electrosurgery 231, 233-234
- G**
- Gag 108, 110
  - Gallipots 66-67
  - Gauze, gauze pads 107, 401-403
  - Gel - antibacterial 417
  - Gel - coagulative 207
  - Gel - lubricant 51, 218
  - Gel - ultrasound, ECG, cosmetic 332, 337
  - Germicidal ultraviolet light 426
  - Gloves - copolymer, cotton, latex, nitrile, vinyl 27-30
  - Gloves - holder for gloves 27, 30, 418
  - Glucose monitor and strips 1-3, 5
  - Goggles 18-19
  - Goniometers 85
- Gouge, blades and handles 47
- Gowns - non-woven, polythene, cotton 30-31, 33
- Grab bars 113
- Grasping tools 105
- Grounding pads and cables 231-232
- Guedel airways 372
- Gynaecological beds/chairs 163-165
- Gynaecology - disposables/tests/sets 214, 221-222
- Gynaecology - forceps and scissors 214-215
- H**
- Hammers 271
  - Hand suction pump 208
  - Hand towels 108
  - Handles for electrosurgery 230
  - Hanger - coats 179-180
  - HARTMANN - Peha® instruments sterile 49
  - Peha-haft® bandages 404
  - Head immobilizers 398
  - Head lights, head loupes, head mirrors 239-242
  - Health monitors 287-290
  - Heating pads and blankets 185
  - Heel protector 128
  - Height measures 87-88
  - HEINE - dermatoscopes 252
  - laryngoscopes 376
  - oto-ophtho and accessories 255-257, 260, 266
  - sphygmomanometers and accessories 306, 310
  - Hemoglobin measures 6-7
  - Histofreezer 237
  - Holloware plastic/stainless steel/disposable 66-68
  - Holter - blood pressure monitoring, ECG 293, 322
  - Hot air sterilizers 427-428
  - Hot-cold gel 186
  - Hot water bottles 186
  - Humidifier 197
  - Hydrogen peroxide 419
  - Hypotermic blanket 380
  - Hystero-graphy cups 214
  - Hysterometer 215
- I**
- Ice pack/spray, bags 186, 380
  - iHealth wireless healthcare products 2, 94, 292
  - Immunoassay analyzer and tests 4
  - Incision film 39
  - Incontinence pads 109
  - Infrared therapy lamps 186
  - Infusion cuffs 365
  - Infusion pumps 366
  - Infusion sets 73
  - Infusion stand 140
  - Inhaler 197
  - Insect repellent devices 97
  - Instruments - stainless steel disposable sterile 49-50
  - Instruments - stainless steel/tungsten 41-48
  - Instruments kits - delivery, dressing, suture 45
  - Invalid rings 108
  - Iodopovidone 419-420
  - Ionophoretic generator 189
  - Ionotens 194
  - Iriscope 251, 255
  - Irrigation devices 267-268
  - Irrigation solutions 414
  - Ishihara test 274
  - Isothermic cover 380
  - IV - catheters 72
  - IV - stands 140
- J**
- Jackets: non-woven, cotton-polyester 33-34
- K**
- KAI: biopsy punches and dermal curettes 64
  - Karman curettes 220
  - Kidney dishes/trays 66-68
  - Kinesiology tapes 404
- L**
- Labeller 436
  - Lactate scout 7
  - LAERDAL - collars 393
  - training manikins and multivenous arms 73, 364
  - Lamps 186, 243-251
  - Lancets 1-3
  - LANG stereotest 274
  - Laryngeal masks 373-374
  - Laryngeal mirrors 46

# INDEX

- Laryngoscopes 238, 375-379  
 Laser therapy 186  
 Laundry trolleys 153-154  
 Lice comb 97  
 Lifters 129  
 Lifting stand 129  
 Light boxes 183-184  
 Lights - examination, magnifying, theatre 179, 243-251  
 Light sources 239  
 Limb clamps 333  
 Lip balm 107  
 LITTMANN® stethoscopes 283-287  
 Loupes - magnifying 241-242  
 Lubricant gel 218  
 Lung exercise devices 318
- M**  
 Magnetotherapy unit 191-192  
 Magnifying lights 250  
 Manikins for training and CPR 363-364  
 Masks - CPR 385  
 - FFP2, FFP3 22-26  
 - reusable 20  
 - surgical 19, 21-22  
 Massage beds and chairs 175-176  
 Mat - absorbent, anti slip 35  
 Mat - decontamination 424  
 Mattress - antidecubitus 127  
 Mattress, covers, pillows 134  
 Mattress - physiotherapy 192, 195  
 Mattress - vacuum 396  
 Mattress - water 126  
 Mayo tables 146  
 Measuring mat 88  
 Medication products 107, 401-416  
 Medipore™ 412  
 Mesotherapy 72  
 MICROLIFE B.P. Monitors 294  
 Micropore™ 412  
 Microscopes 15, 251-253  
 MINDRAY ECG, ultrasound, pulseoximetry 326, 339-340, 388  
 Mirrors ENT 240  
 Mirrors larynge 46  
 Mitten 110  
 MITSUBISHI videoprinter papers 336  
 Models - teaching 449-454  
 Monitor multiparameter and accessories 345-351  
 Monofilament 271  
 Monopolar - forceps, scissors, cables, handles 231  
 Mouthpieces - spirometry 317  
 MulticareIN device and strips 5
- N**  
 Nail - scissors, cutters, files 47, 107  
 Napkins 108  
 Nasal speculum 269  
 Nasal wash 197  
 Nebulizers and accessories 198-200  
 Needle holders 41, 43, 45, 49-50, 53  
 Needles 69-73  
 Nelaton catheter 51  
 Netting - tubular 403  
 NONIN - pulseoximeters 388, 390  
 Nose clips for spirometry 317  
 Nosepharyngoscope 238  
 Nystagmus spectacles, videonystagmoscope 272
- O**  
 Occluders 273  
 Office furniture for doctors 177-182  
 OMRON - B.P. Monitors 294-296  
 - scales 92-93  
 - thermometers 99-100  
 Operating room - tables 144  
 - instrument table and cabinet 144-145  
 Ophthalmic drapes 39  
 Ophthalmoscopes 255-264  
 Optical tests 273-274  
 Optometric charts 183-184, 273  
 Orchidometer 87  
 Orthopedic products 393-395  
 Otoscillo irrigation device 267  
 Oscopes and accessories 253-266, 288  
 Overbed tables 131  
 Ovulation test 221  
 Oximeters 386-392  
 Oxygen concentrators 368  
 Oxygen cylinders and accessories 369
- P**  
 Pads for defibrillators 353-354  
 PAP devices 315  
 Pap test 218  
 Paper for ECG, ultrasound, defibrillator 331-332, 336, 354  
 for foetal monitor 212  
 Paper products (towel, napkins) 108  
 Papettes 214  
 PARAGON blades and scalpels 62  
 Patient trolleys 141-143  
 Peak flow meters 318-319  
 Pedal exercisers 125  
 Pediatric tables, beds, cradles 132-133  
 Peha-haft Hartmann cohesive bandages 404  
 Peha Hartmann instruments 49  
 Pen-lights 263, 270  
 Percussors 271  
 Perforator, membrane 214  
 Pessaries - rubber, silicone 222  
 Physiotherapy 195-196  
 Pill cutters/crushers/boxes/planners 103-105  
 Pillows 128, 134  
 Pipettes 16  
 Plasters 107, 410-412  
 Plates, cup and glass for patients 106  
 Plates for electrosurgery 231-232  
 Plumbing weight 85  
 Pneumatic tourniquets 365  
 Pocket masks 385  
 Podiatry - chairs 168  
 - devices 85  
 - instruments and kits 47  
 Podoscope 85  
 Posture analyzers 85  
 Pouches for sterilisation 437  
 Pregnancy tests 221  
 Pressure reducers 369  
 Printers 336  
 Probe covers - latex 212  
 Proctoscopes 216, 218  
 PT/INR coagulation monitoring system 6  
 Pulse oximeters and sensors 386-392
- R**  
 Razors 60  
 Record holders 134  
 Rectal catheters 51  
 Refrigerator bags 78, 80  
 Removal kits 53, 59  
 Reservoir bags 370-371  
 Respiratory 316-321  
 Resuscitators and accessories 370-372  
 Retractors 49  
 RIESTER - camera system 253  
 - infusion cuffs 365  
 - oto-ophtho and accessories 253, 256, 259-260, 262, 265-266  
 - pneumatic tourniquets 365  
 - sphygmomanometers 291, 293, 299, 306-308  
 - stethoscopes 281  
 - thermometer 98  
 - vital signs monitor 348  
 Rollators 120-121  
 Rolls for sterilization 437  
 Room furniture 132
- S**  
 Salpingograph - Schultze 210  
 Saw for plaster 409  
 Scales - baby/adult/vet 88-89, 91-96, 440  
 Scalpels - disposable or stainless steel 43, 61-62  
 Scalps vein 69  
 Scissors 38, 42-43, 45-47, 49-50, 53, 107, 374  
 Scoliometer 85  
 Scooping stretcher 398  
 Scrubs 420  
 Sealings/thermowelders 435-436  
 Seals for containers 433  
 SECA - scales, measurers 86-88, 94-95  
 Sharps bins 73-74  
 Shelving system 145  
 Shields protective 17, 19  
 Shoe covers 32  
 Shoe for plaster 393  
 Shower - chairs, mattress, trolleys 113-116, 137  
 Sigmoidoscopes F.O. 216  
 Silicone tubes 207  
 Sleep apnea 316



Slides	220
Skeletons, spinal columns ad skulls	449-454
Skin staple removers	59
Skinfold calipers	90
Skin markers	54
Smoke evacuator	235
Sneakers	36
Soap	110, 418
Socks for compression	111-112
SONY - videoprinter papers and printers	336
Spacer for aerosol	318
Specula - ear, nasal	265-266, 269
Specula - vaginal	217-218
Sphygmomanometers - aneroid and accessories	299-310
Sphygmomanometers - digital	288-298
Spinal boards	397
Spirometry - equipment	317-321
Spirometry - paper, mouthpieces, filters, turbines	317
Splinters	97, 385
Splints - aluminium/air/nylon	395-396
SpO <sub>2</sub> sensors for monitors and pulseoximeters	351-352
Sponges	106, 110
Spray for cytology fixation	220
Stainless steel instruments/holloware	38-50, 67-68, 431-432
Stereoptic tests	274
Steri-strip™	410
Sterilization boxes, containers and accessories	431-432
Sterilization test and tapes	433-435
Sterilizers - dry heat	426-428
Stethoscopes and accessories	212, 275-287
Stethoscope digital	281, 287
Sticks	117-118
Stockings for compression	112
Stools	163, 181
Stools - bathroom	113
Strep-A rapid test	9
Stretchers - emergency	397-400
Stretchers - hospital	141-143
Suction catheter	51
Suction pumps and accessories	201-208
Surgery sets	40, 53
Surgical instruments	41-46, 49-50, 53-62
Surgilance safety lancets	3
Sutures	53, 55-60
Sutures training kit	155
Swabs - cotton	219, 401-403
SWANN-MORTON blades and scalpels	62
Syringe pumps	366
Syringes	69-72
Syringes ear	267

## T

3M - dressing and bandages	406, 408-416
- electro-surgery pads	231
- Red Dot™ electrodes	332
- staple remover, skin stapler and surgical clipper	59, 60
- stethoscopes	283-287
Tables - theatre	144
- treatment	169-176
Tape dressing	411-414
Tape height measures	87
Tape indicators steam	433-434
Tape kinesiology	404
Tecar therapy and cream	188, 337
Tegaderm™	416
Tens - nerve stimulator	193-194
TERUMO® syringes and needles	70
Test tubes	16
Tests - alcohol, drug	13-14
Tests - COVID-19	9-10
Tests - gynaecology	221-222
Tests - influenza, strep-A, mononucleosis, D-dimer, CRP, allergy, microalbuminuria, helicobacter pylori, prostate, malaria, FOB, colon disease	4, 8-9
Tests - urine	11-12
Thermal recording paper	212, 331-332, 354
Thermic pads, bottles, bags, devices	186
Thermo feel	271
Thermometers	98-102, 221
Throat scope - illuminator	269
Toilet aids	114-116
Tongue depressors	269-270
Tonometer Schiötz	274
Torches	263, 270
Tourniquets	75-76
Tourniquets pneumatic	365
Towels	108
Transpore™	412

TravelJohn urine and vomit bag	109
Trays ISO format	155
Treatment couches	175-176
Tripod and quadcane	118
Trolleys - ABS and aluminium	149-150
- aluminium and stainless steel	146-148
- bag holder and laundry	153-154
- dressing and multifunction	155-161
- emergency	155-160
- for monitors and ventilators	150
- pharmacy	151-152, 155
- patients	141-143
- utility	161-162
Trousers	30, 33-34
Tungsten carbide instruments	41-42
Tuning forks	272
Tympanometer and eartips	311-312
Two points discriminator	271

## U

Ultrasonic cleaners	425
Ultrasonic nebulizers	198
Ultrasound dopplers	339-342
Ultrasound therapy	189-190
Ultrasound wireless dopplers	343-344
Ultraviolet lamps	251, 426
Umbilical clamps	214
Urine analyser and strips	11-12
Urine bags	109
Urine containers	65-66

## V

Vaccine carrier	78
Vein finder	75
Ventilators	367
Venturi oxygen masks	370
Veterinary equipment and instruments	438-448
Videolaryngoscope	375
Videonystagmoscope	272
Videoprinter paper	336
Videoscope, videodermatoscope, Videocapillaroscope, videoiriscopes	251-255, 288
Visors	17, 19
Vital signs monitors and accessories	345-351
Vomit bag	109

## W

Walking frames, sticks, crutches	117-120
Wall units	162
Ward screens	139, 177
Warmer - blanket, pads and foot	185
Wash basin pump	161
Washer bedpan	426
Waste containers	73-74
Watches	38
WC, portable	109
Wheelchairs	122-125
Wheelchair stretchers	399-400
Wing screens	139, 177
Wipes	108, 418-419
Wood lamps	251
Worktops	162
Worth led light test	274
Woundcare	412, 415-416

## X

X-ray viewers	183-184
---------------	---------

## Y

Y tubing	275
----------	-----

# MEDICAL DEALERS ONE-STOP SHOP FOR OVER 9,500 PRODUCTS

- ✓ Quick delivery all over the world and possibility of drop shipment
- ✓ Unique supplier for over 9,500 products
- ✓ Quality and certified products
- ✓ Easy ordering and no minimum order
- ✓ Careful staff and technical support
- ✓ Competitive prices and special offers
- ✓ Strong catalogue and web support to your sales
- ✓ Over 1,000 new innovative products launched this year
- ✓ Personalized catalogue on request

## Continuous technology, marketing and logistic improvements include:

- 1 - 8 language packaging and manual (GB, FR, IT, ES, PT, DE, GR, Arabic) for more than 3,000 products
- 2 - 1,000 new products
- 3 - Appealing A4 catalogue to support your sales
- 4 - English, French or Italian catalogue
- 6 - Improved customer friendly website
- 7 - 8,000 m<sup>2</sup> on site and 6,000 m<sup>2</sup> outsourcing logistic facilities
- 8 - Green policy: - photovoltaic plant for 175,000 kwh/year for electric power self sufficiency  
- geothermal system for warehouse heating savings

## 14,000 PALLETS LOGISTIC FACILITIES (8,000 ON SITE + 6,000 OUTSOURCING)



10,000 m<sup>2</sup> warehouse - 8,000 overall pallet capacity



Compact storage mobile rack on rail



6,000 drawers automated picking system



Loading docks for easy and quick shipment

## BRANDS

We have in stock, ready for delivery, most of the products of the following brands. We can also supply in 20-60 days additional products that are not in our catalogue. Please let us have the item code of supplier and we will quote soon. As these are special orders, once approved they can not be cancelled. Minimum order value: 150 Euro.



## INTERNATIONAL TENDERS - TURN-KEY PROJECTS

With over 9,500 products in stock, Gima is the ideal partner for companies who participate to turn-key projects. English, French and Italian catalogue and website (with possibility to download pictures, manuals, certificates, etc.) are perfect instruments for an easy and quick search of thousands of products and allow real-time bid to tender invitations.

After receiving an enquiry, Gima will issue an offer including items in catalogue with similar features, but frequently not exactly complying with tender requirements. Customers should check under their own responsibility if discrepancies are acceptable before their offer for tender. Gima will supply technical material (available for download on [www.gimaitaly.com](http://www.gimaitaly.com)) that can be used by customer for tender requirements.

Gima does not fill in tender documents or compliance sheets.

# WWW.GIMAITALY.COM

## MULTILINGUAL WEBSITE

- 3 OFFICIAL LANGUAGES: ENGLISH, FRENCH, ITALIAN

## FROM OUR WEBSITE YOU CAN DOWNLOAD

- PRODUCT DESCRIPTION AND FEATURES
- PRODUCT PICTURES AND VIDEO
- MULTILINGUAL USER MANUALS with language index
- PRODUCT LABEL & PACKAGE
- HIGH DEFINITION PDF single catalogue page
- LOW DEFINITION PDF complete catalogue
- DECLARATIONS OF CONFORMITY
- ISO 9001:2015 AND ISO 13485:2016 CERTIFICATES
- CE CERTIFICATES
- FREE SALE CERTIFICATES
- SAFETY DATA SHEET
- CND, GMDN, UMDNS CODES
- EAN 13 CODES

**ON-LINE  
STOCK  
AVAILABILITY**



**PDF CATALOGUE ON  
www.gimaitaly.com**

# PERSONALIZED GIMA CATALOGUE

Get new sales opportunities with personalization of English, French or Italian catalogue

- GIMA A4 ANONYMOUS CATALOGUE** with space for your label - 10 free catalogues with order (on request) and extra copies with charge
- GIMA A4 CATALOGUE with your logo** - minimum order: 100 pcs  
Your logo and address on back cover and inner front cover



Gima anonymous catalogue can be personalized with your logo and address printed here

- GIMA A4 CATALOGUE with personalized cover** - minimum order: 500 pcs  
4 cover pages fully personalized by you in your language (artwork cost not included)

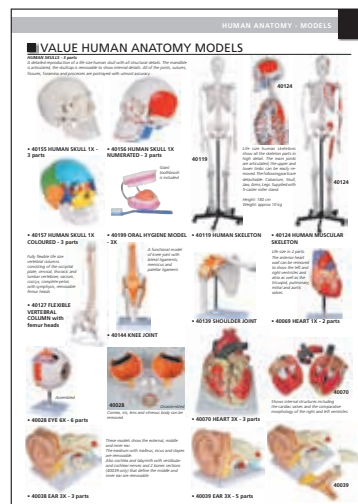

ASK FOR PRICE

# GLUCOSE MONITORS, SMART DIABETES MANAGEMENT

## ADVANCED FEATURES FOR DIABETES MANAGEMENT:

- no-coding** technology
- 10-70% HCT** range allows neonatal and anemic blood samples
- GDH-FAD** enzyme allows capillary, venous, arterial blood samples. No interference from maltose, galactose...
- large display screen** for easy reading
- strip ejector** avoid cross-contamination
- 1,000 test memory** with date and time
- auto sample identification** (blood/control solution)
- 7, 14, 30, 60 and 90-day averages calculation**
- Ketone & Hyper/Hypo** warnings
- meal-marker** function to monitor results before and after meals
- automatic detection** of insufficient sample

Powered by ACON



5 YEARS WARRANTY

### GIMA GLUCOSE MONITORS

Accurate and reliable glucose monitors for self testing and professional use. Extensive clinical studies demonstrate the accuracy of Gima glucose monitoring system, powered by Acon, with fresh capillary, venous, neonatal blood samples. Comply with ISO15197:2013/EN ISO15197:2015.

**Available as meter only or complete kit.**

Kit includes 10 strips, control solution, 10 sterile lancets, lancet device, clear cap (for testing on forearm or palm), carrying case, user manual.

**Bluetooth version (24114 only):**

Fully integrated Bluetooth allows for data transmission to data management platforms.

#### TECHNICAL SPECIFICATIONS

Technology:	Biosensor/Electrochemical, Glucose dehydrogenase (GDH-FAD)
Calibration method:	No coding
Result calibration:	Plasma-equivalent
Test time:	5 seconds
Sample size:	0.6µL
Sample type:	Fresh whole blood (capillary, venous, neonatal)
Test sites:	Fingertip, forearm, palm
Hematocrit range:	10-70%
Memory storage:	1,000 results with date and time
Test averaging:	7, 14, 30, 60, 90-day averages
Data transfer:	USB cable - optional
Control solution:	3 levels
Automatic shutoff:	2 minutes after last action
Battery:	2x CR 2032 3.0V coin cell batteries
Battery life:	3,000 measurements
Other functions:	Automatic detection of insufficient sample 2nd sample application allowed Sample perturbation detection



24114

Multilingual box and manual: GB, FR, IT, ES, PT, DE, GR, SE  
\*Manual not included in the box, only for download from [www.gimaitaly.com](http://www.gimaitaly.com)



24118

GIMA code	GIMA GLUCOSE MONITOR METER OR KIT	Languages box and manual
24108	GIMA Glucose monitor - meter only	GB, IT, SE, FI
24110	GIMA Glucose monitor kit	GB, FR, ES, PT
24111	GIMA Glucose monitor kit	IT, DE, GR, Arabic
24114	GIMA Glucose monitor kit - Bluetooth	GB, FR, IT, ES
ACCESSORIES AND CONSUMABLES FOR GIMA GLUCOSE MONITOR		
24118	Glucose Strips - box of 25 strips*	
24119	Glucose Strips - box of 50 strips*	
24120	Glucose Strips - box of 100 strips*	
24121	Control Solution	
23919	Auto lancet device	
23917	Lancets 28G for 23919 - sterile - box of 25 pcs	
23916	Lancets 28G for 23919 - sterile - box of 100 pcs	
23918	Lancets 30G for 23919 - sterile - box of 100 pcs	
24125	USB cable Glucose Monitor - PC	

\*Maximum shelf life: closed vial 24 months, open vial 18 months

# ON CALL PLUS, PLUS II STRIPS AND GLUCOSE MONITOR mmol/L

GIMA code	GLUCOSE MONITOR ON CALL PLUS II - mmol/L	Languages box, manual
23886	Glucose monitor On Call Plus II kit - mmol/L	GB, FR
ACCESSORIES AND CONSUMABLES FOR GLUCOSE MONITOR ON CALL® PLUS AND ON CALL® PLUS II		
23910	Glucose Strips - box of 25 strips	
23912	Glucose Strips - box of 50 strips	
23913	Glucose Strips - box of 100 strips	
23914	Control Solution	
23919	Auto lancet device	
23917	Lancets 28G for 23919 - sterile - box of 25 pcs	
23916	Lancets 28G for 23919 - sterile - box of 100 pcs	



23913

Kit includes 10 strips, code chip, control solution, 10 sterile lancets, lancet device, clear cap (for testing on forearm or palm), carrying case, user manual.

23886

mmol/L



# iHEALTH GLUCOSE MONITORS - iHEALTH GLUCO APP

## • 23514 iHEALTH GLUCO+ BG5s SMART GLUCOSE MONITOR KIT

Pocket sized, ergonomic, wireless glucose monitor with advanced technology and high reliability. The Wireless Smart Gluco-Monitoring System is a convenient way to measure and record your blood glucose levels from your mobile device.

- view results instantly on the wireless meter
- save up to 500 test results on the wireless meter
- set up reminders and view glucose and insulin trends in multiple ways
- track test strip quantity and expiration dates automatically, no counting or coding required
- works on-line and off-line, with data automatically uploading at each connection.

Kit includes 10 lancets, lancing device, USB charging cable and travel case.

## • 23509 iHEALTH ALIGN - BG1 GLUCOMETER

Economic, button size model with advanced technology and good reliability. A convenient way to measure your blood glucose monitor and transmit by your Phone. Supplied with 10 lancets, lancing device, 2 lithium batteries CR1620, 10 smartphone protection sleeves and pouch.

### TECHNICAL SPECIFICATIONS

Machine size:	98x35x27.8 mm (23514) - 52x30x9.5 mm (23509)
Measuring method:	Amperometric technology using glucose dehydrogenase (FAD-GDH)
Result range:	20 mg/dL-600 mg/dL (1.1 mmol/L-33.3 mmol/L)
Power source:	DC 3.7 V (23514) - DC 3.0, CR 1620 (23509)
Blood source:	Fresh capillary whole blood
Blood volume:	Min. 0.5 micro liter



It allows to manage all your smart iHealth devices and track relations among parameters. See page 292



23514



iHealth Gluco-Smart App, available in GB, FR, IT, ES, DE, CZ, SK, HR, TR, IR, CN, Arabic.

Phone not included



23509

Connection through jack of the smartphone



23509

GIMA code	GLUCOSE MONITOR ACCESSORIES
23511	Glucose strips* - box of 25
23512	Glucose strips* - box of 50
23916	Lancets 28G - box of 100
23919	Auto lancets device "On Call"

Ear phone universal plug compatible with any mobile

\*No coding strips: no need to calibrate glucometer any time. These strips are automatically identified by glucometer.

# 24-HOUR GLUCOSE MONITORING SYSTEM

## 24-HOUR GLUCOSE MONITORING SYSTEM

Real time blood glucose monitoring system for detection of trends and tracking of patterns in adults with diabetes. The integrated wearable sensor works through enzymatic electrochemical reactions with glucose: the enzyme, glucose oxidase, allows glucose to be converted into an electronic signal. Signals are transmitted to POCtech CGM App for continuous monitoring of readings every 3 minutes for up to 10 days. The system consists of a sensor and transmitter which can be placed on upper arm or abdomen.

- continuous monitoring of value changes at night
- easy check of blood glucose before and during exercise
- every action can be tracked by note function
- every meal can be measured in a healthy way
- lower MARD\* guarantees better accuracy
- new and updated chip effectively eliminates interferences
- check of real time data without scanning
- innovative and flexible electrode, soft and painless
- patented blank electrode design sensitive to changes in glucose level
- IPX7 water resistant
- low glucose alert
- 10 days accuracy

Supplied with battery, quick start guide and user manual GB, IT.



24170

24171

GIMA code	24-HOUR GLUCOSE MONITORING SYSTEM	Duration of use
24170	Sensor and applicator - sterile	10 days
24171	Data transmitter	2 years



Sensor is inserted into the skin through pen applicator



Transmitter installation to the sensor

TECHNICAL SPECIFICATIONS	
Reading technology:	electro-chemical method
Glucose range:	30-450 mg/dL
Measurement timing:	every 3 minutes
Sensor accuracy (MARD)*:	9.6-12%
Sensor life:	10 days
Altitude operating range:	0-2000 m
Power supply:	3V button cell for transmitter

\*Mean Absolute Relative Difference



Sensor and applicator



Data transmitter

24171



Sensor

24170

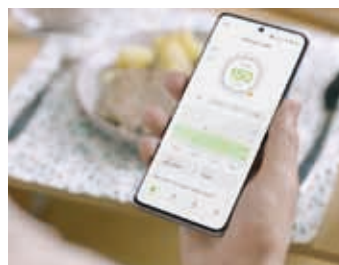

Every meal can be measured in a healthy way



IPX 7 water resistant material



Every action tracked



Low glucose alert

## LANCETS AND LANCET DEVICE

### 23919 AUTO LANCET DEVICE

Reusable auto lancet plastic device, adjustable tip, allows precise configuration of lancet penetration, with 10 adjustable depths. Lancet ejector for safe disposal of the lancet. Instructions: GB, FR, IT, ES.



23919

- 23917 GIMA LANCETS 28G - sterile - box of 25 pcs
  - 23916 GIMA LANCETS 28G - sterile - box of 100 pcs
  - 23918 GIMA LANCETS 30G - sterile - box of 100 pcs
- Fine needles usable with code 23919 and most of lancet devices in the market to draw a blood sample for glucose testing.



Multilingual box: GB, FR, IT, DE, ES, PT, GR, PL, CZ, Arabic

## ABBOTT GLUCOSE STRIPS

ABBOTT FREESTYLE OPTIUM BLOOD GLUCOSE TEST STRIPS		
GIMA code	Compatibility	Minimum order
23942	FreeStyle Optium Neo, FreeStyle Libre, FreeStyle Optium, Optium Xceed, Optium, Optium Easy, Boots	box of 25
23943		box of 50
ABBOTT FREESTYLE LITE BLOOD GLUCOSE TEST STRIPS		
23944	FreeStyle Lite, FreeStyle Freedom Lite, FreeStyle InsuLinx, FreeStyle Navigator II	box of 25
23945		box of 50



Abbott 23944-5

23942-3

## GIMALANCET SQUARE AND ROUND SAFETY LANCETS - STERILE

Easy to use, comfortable, safety lancets to meet various capillary blood requirements.

- **single-use:** the build-in-self-destructing design can prevent reuse of the device
- **no accidental injury risk:** needle is hidden before and after use to prevent accidental injuries
- **sterilization guaranteed:** the lancet is Gamma sterilized and the needle tip is protected with a sterility tab until its use allowing a long shelf life
- **no blood contamination**

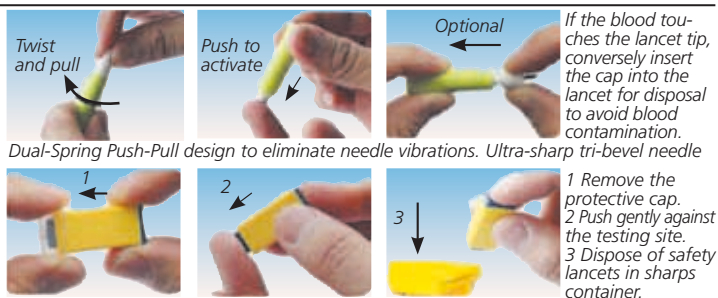

Dual-Spring Push-Pull design to eliminate needle vibrations. Ultra-sharp tri-bevel needle

Easy to use pre-loaded and pressure activated device

High quality tri-bevel needle high-speed penetration with single spring

GIMA ROUND SAFETY LANCETS - NEEDLES									
GIMA code	Colour	Depth of penetration	Gauge	Blood Flow	Finger Stick	Glucose	Hematocrit	Bleeding	Minimum order
24451	Yellow	2.2 mm	G21	40-60 µl	•	•	•	High	box of 100
24453	Green	2.2 mm	G23	40-60 µl	•	•	•	High	box of 100
24454	Light blue	1.8 mm	G26	5-10 µl	•	•	•	Medium	box of 100
24455	Purple	1.8 mm	G28	5-10 µl	•	•	•	Low	box of 100
GIMA SQUARE SAFETY LANCETS - NEEDLES									
24461	Orange	2.2 mm	G21	40-50 µl	•	•	•	High	box of 100
24463	White	1.8 mm	G23	20-40 µl	•	•	•	Medium	box of 100
24465	Purple	1.8 mm	G28	5-10 µl	•	•	•	Low	box of 100



Multilingual box and instructions: GB, FR, IT, ES, PT, DE, PL, CZ, SE, RO, SK, NL, DK, FI, EE, HR, HU, LT, LV, NO, SI, BG, RU, GR, Arabic.

## SURGILANCE SAFETY AUTOMATIC LANCETS - STERILE

### SURGILANCE SAFETY AUTOMATIC LANCETS - NEEDLES

Multi purpose capillary blood sampling devices for all testing requirements.

The one-step safety lancet is easier to use, no arming is required, and safer, once lancet is used it is rendered inoperable.

High-speed delivery and penetration method minimizes patient pain and operator error.

Latex-free, hypo-allergenic, disposable, sterile.

Multilingual manual on [www.medipurpose.com](http://www.medipurpose.com)



Multilingual box: GB, FR, IT, ES, DE, PT, NL, SE, DK, RU, GR.

24515

SURGILANCE™ SAFETY LANCETS - NEEDLES									
GIMA code	Colour	Depth of penetration	Entire needle Gauge	Needle tip Gauge	Blood Flow	Finger Stick	Glucose	Hematocrit	Minimum order
24513	Yellow	1.0 mm	G21	G26	5-10 µl	•	•	•	box of 100
24514	Grey	1.8 mm	G21	G23	10-20 µl	•	•	•	box of 100
24515	Orange	2.2 mm	G21	G22	20-40 µl	•	•	•	box of 100
24517	Pink	2.8 mm	G21	G21	40-60 µl	•	•	•	box of 100



# FLUORESCENCE IMMUNOASSAY ANALYZER

## • 24600 FLUORESCENCE IMMUNOASSAY ANALYZER

Fluorescence Immunoassay Analyzer is an analyzer based on detection of fluorescence emitted during an immunoassay with antigen-antibody interaction. The analyzer is designed to provide quantitative or qualitative test results by the examination of human samples with specific in vitro diagnostic test units. It offers advantages of high accuracy, strong stability and fast results. Tests can be analyzed choosing between Quick Test mode or Standard Test mode.

### Quick Test mode

Incubation of the test cassette is done outside the analyzer. It is also called "Batch mode" as multiple tests can be done in one batch, without waiting for finishing incubation of one test after another.

### Standard Test mode

Incubation of the test cassette is done inside the analyzer. It is also called "Single Test mode", once the cassette is loaded after sample addition, a countdown starts and the user can walk away because the results will be automatically available after incubation period.

The analyzer requires the external software download, that allows to upload and save test records on Windows-based system PCs, if connected with USB cable.

For professional laboratories only.

Internal software in GB, FR, IT, ES, PT, DE switchable by users.

Supplied with QC ID Card, QC standard cassette, built-in battery, USB cable and multilingual manual (GB, IT).



### ANALYZER TECHNICAL SPECIFICATIONS

Principle:	Fluorescence immunoassay	Connectivity:	RS232, USB port, Bluetooth
Test format:	cassette	Compatibility:	Windows-compatible proprietary program
Specimen:	urine/plasma/serum/whole blood/swab	Built-in battery:	rechargeable Li-ion battery NCR 18650B (MH12210)
Detection type:	quantitative or qualitative	Charging time:	3-8 hours
Reading time:	< 10 seconds	Power source:	2*3400 mAh
Display:	4.3" LCD touch screen	Size:	220x100x75 mm
Memory:	4000 records	Weight:	< 1.5 kg

### HARDWARE AND SOFTWARE REQUIREMENTS

Minimum hardware requirements:  
Intel Pentium IV 1.0 GB processor,  
1.0 GB memory, 10 GB space on hard drive  
Minimum software requirements:  
Microsoft Windows XP, Windows 7  
Microsoft Excel 2007 or newer versions

## CASSETTE TESTS

Ready-to-use tests compatible with the fluorescence immunoassay analyzer.

12 cassette tests available with immediate results to measure or diagnostic different diseases.

Tests belong to different categories: inflammatory markers (CRP test); coagulation (D-dimer test); nephrology (Kidney failure and Procalcitonine tests); diabetes (Glycated Hemoglobin test); infectious diseases (Influenza A/B, Strep A, RSV, Covid-19 tests); cardiac (CTnI Troponin I); Vitamin D test.

### TEST TECHNICAL SPECIFICATIONS

Tests	Specimen Type	Measuring range	Reaction time	Detection	Accuracy
CRP test	WB/S/P	0.5~200 mg/L	3 min	Quantitative	± 15%
Procalcitonine test (PCT)	WB/S/P	0.1~50 ng/mL	15 min	Quantitative	± 15%
D-dimer test	WB/P	0.1~10 mg/L	15 min	Quantitative	± 15%
cTnI Troponin I test	WB/S/P	0.1~40 ng/mL	15 min	Quantitative	± 15%
Kidney failure test (N-GAL)	Urine	10~1500 ng/mL	10 min	Quantitative	± 15%
Glycated Hemoglobin test (HbA1c)	WB	4~14.5%	10 min	Quantitative	± 15%
Influenza A/B test	Swab	5~300 mg/L	15 min	Qualitative	98.5-99.3%
Strep A test	Swab	1.0x10 <sup>6</sup> org/mL	15 min	Qualitative	97.1%
Respiratory Syncytial Virus (RSV) test	Swab	1.0x10 <sup>6</sup> TCID 50/mL	15 min	Qualitative	-
COVID-19 Antigen test	Swab	-	10 min	Qualitative	97.53%
COVID-19 Antibody test	WB/S/P	-	15 min	Qualitative	96.9%
Vitamin D test	WB/S/P	5~100 ng/mL	15 min	Quantitative	± 15%

GIMA code	CASSETTE TESTS FOR 24600	Minimum order
24605	CRP test	box of 10
24606	Procalcitonine test (PCT)	box of 10
24608	D-dimer test	box of 10
24610	CTnI Troponin I test	box of 10
24612	Kidney failure test (N-GAL)	box of 10
24614	Glycated Hemoglobin test (HbA1c)	box of 10
24618	Influenza A/B test	box of 10
24619	Strep A test	box of 10
24620	Respiratory Syncytial Virus (RSV) test	box of 10
24622	COVID-19 Antigen test	box of 10
24623	COVID-19 Antibody test	box of 10
24625	Vitamin D test	box of 10

CONTENT OF KITS	ID Card	Cassette	Buffer	Safety lancets	Dropper 1 or 2	Workstat. tube, swab
CRP	•	•	•	•	2	•
Procalcitonine (PCT)	•	•	•	•	1	•
D-dimer	•	•	•	•	1	•
cTnI Troponin I	•	•	•	•	1	•
Kidney failure (N-GAL)	•	•	•	•	1	•
Glycated Hemoglobin (HbA1c)	•	•	•	•	2	•
Influenza A/B	•	•	•	•	•	•
Strep A	•	•	•	•	1	•
Respiratory Syncytial Virus (RSV)	•	•	•	•	•	•
COVID-19 Antigen	•	•	•	•	•	•
COVID-19 Antibody	•	•	•	•	2	•
Vitamin D	•	•	•	•	•	•

\*1 dropper always 75 µl, 2 droppers 75 µl + 10 or 20 µl

# COMBISCREEN® mALB/CREA - MICROALBUMINURIA DETECTION

## • 24056 COMBISCREEN® mALB/CREA - tube of 25

Visual test for detection of microalbuminuria, based on albumin-to-creatinine ratio that provides accurate information on albumin level in urine, regardless of the urine concentration. The low detection limit of 22 mg/L enables reliable screening of risk patients.

Result is available in 60 seconds and can be easily read from a table provided with the label or automatically interpreted with Urilyzer® 100 Pro (24049).

Ideal for people with chronic conditions, such as diabetes and high blood pressure. No 24 h sample collection is necessary. Designed for healthcare professionals.

24056



# MULTICAREIN MULTIPARAMETER DIAGNOSTIC DEVICE

- 24147 MULTICAREIN\* - Italian
- 24148 MULTICAREIN\* - English

\*Supplied with nylon bag, 5 cholesterol strips, 5 safety lancets, rapid guide (GB, FR, IT, ES, PT, GR, PL, HU) and IT or GB manual.

- 24149 MULTICAREIN STARTER KIT\*\* - GB, IT
- 24153 MULTICAREIN STARTER KIT BLUETOOTH\*\*

\*\*Supplied in cardboard box with a nylon bag, 10 glucose, 5 cholesterol, 5 triglycerides strips, 25 safety lancets, user manual (GB, IT), rapid guide and QR code with complete manual in 8 languages (GB, IT, FR, ES, PT, GR, PL, HU).

Multiparameter diagnostic device for the periodical self-monitoring of risk factors: cholesterol, triglycerides and glucose. Portable device for easy test procedure and quick results. Accurate with Amperometric Technology for glucose and Reflectometric Technology for cholesterol and tryglicerides. Switchable mg/dL - mmol/L. Multilingual box: GB, FR, IT, ES, GR, PT, PL, HU, RU and selectable internal software: GB, IT.

- 23982 SOFTWARE+CABLE FOR MULTICAREIN - GB, IT, - optional
- Operating system: Windows XP, 7, 8, 10, Vista, 16 Mb Ram.



SELF CONTROL 0344

ISO 15197:2015

MULTICAREIN



24147, 24148



3 IN 1: CHOLESTEROL, TRIGLYCERIDES, GLUCOSE

24149



The first and only multi-parameter device with double technology  
**AMPEROMETRIC SUCTION STRIP - glucose** Amperometric

- Electro-chemical technology for a practical use
- Requires very little blood samples (0.5 µl)
- Short time for the results (5 sec.)



**REFLECTOMETRIC SUCTION STRIP - cholesterol and tryglicerides**  
- It allows a more functional self-monitoring of triglycerides and cholesterol.



Tube of 5	Tube of 25	Tube of 50	STRIPS FOR MULTICAREIN*** 9 LANGUAGE BOX - spare
-	24156	24157	Glucose strips biosensor + 1 chip
24158	24159	-	Cholesterol strips + 1 chip
24160	24161	-	Triglycerides strips + 1 chip

Strips are sold in a 9 languages box: GB, IT, FR, ES, PT, PL, GR, HU, Arabic.

GIMA code	CONTROL SOLUTION FOR MULTICAREIN***
23978	Glucose control solution
23979	Cholesterol control solution
23980	Triglycerides control solution

GIMA code	LANCETS FOR MULTICAREIN***
23917	Lancets 28G - sterile - bag of 25 pcs
23916	Lancets 28G - sterile - box of 100

\*\*\*All spares are compatible with old Multicare versions



Cholesterol      Glucose      Triglycerides

	TECHNICAL SPECIFICATIONS	
	Measuring range	Measuring time Blood sample
Glucose electro-chemical:	10-600 mg/dL - 0.6-33.3 mmol/L	5" 0.5 µl
Cholesterol	130-400 mg/dL - 3-10.2 mmol/L	30"-60" 10 µl
Triglycerides	50-500 mg dL - 0.56 - 5.6 mmol/L	30"-60" 10 µl
Memory:	500 test results with date and time	
Display:	LCD	
Batteries:	2 lithium batteries Cr 2032 3 Volts (32212) suitable for 1 year or 1,000 measurements	
Size - weight:	97x49x20.5 mm - 65 g (battery included)	

# MISSION® CHOLESTEROL METER + LIPID PANEL TEST

- 23932 MISSION® CHOLESTEROL METER

Provides high quality and reliable results for complete Lipid Panel testing in ≤2 min.

**3 in 1 complete Lipid Panel device tests** for Total Cholesterol (CHOL), High Density Lipoprotein (HDL) and Triglycerides (TRIG)

**Also includes calculated tests:** Low Density Lipoprotein (LDL), CHOL/HDL ratio and Cardiac Risk Assessment

**Reliable**

- can test whole blood, 0123 serum or plasma
- wide hematocrit range of 0-50%
- small printer available for immediate printing of results

**Easy to use**

- large LCD display for easy reading
- colour coded test devices with engraved test name for easy identification

Supplied with 2 control devices, 4 batteries, carrying case and manual (GB, IT). **23932**

Available FR,ES, DE, PT manual in [www.gimaitaly.com](http://www.gimaitaly.com)

Multilingual box: GB, FR, IT, ES, DE, PT, PL, SE, FI, GR, NL, RO, BG, RU, SA.



TECHNICAL SPECIFICATIONS

Detection principle	Reflectance Photometry
Time to results	≤ 2 minutes
Memory with date/time	200 results
Type of test	Quantitative
Tests	CHOL, HDL, TRIG
Calculated tests	LDL, CHOL/HDL ratio, Cardiac Risk Assessment
Specimen volume	3-1 Lipid Panel Device: 35 µL CHOL Individual Test Device: 10 µL
Measurement units	mg/dL or mmol/L
Measurement range	CHOL: 100-500 mg/dL (2.59-12.93 mmol/L) HDL: 15-100 mg/dL (0.39-2.59 mmol/L) TRIG: 45-650 mg/dL (0.51-7.34 mmol/L)
Pc interface for data transfer	Mini USB Port
Calibration	Code Chip
Languages on the screen	English abbreviations
Power source	4 AAA or AC Adaptor (Mini USB, 5V dc, 50 mA)
Battery life	≥ 1,000 tests
Automatic shut off	5 minutes
Meter dimensions - weight	137x79x26 mm (5.4" x 3.1" x 1.0") - 145 g (5.11 oz)
Display dimensions	50x50 mm (2.0" x 2.0")

GIMA code	ACCESSORIES AND SPARES	Minimum order
23935	3 in 1 Lipid panel tests + capil. tubes 35 ul + lancets*	box of 5
23933	3 in 1 Lipid panel tests + capillary tubes 35 ul	box of 25
23934	Total Cholesterol tests + capillary tubes 10 ul	box of 25
24024	Capillary transfer tubes 10 ul - plastic	box of 50
23917	Gima lancets 28G	box of 25
23916	Gima lancets 28G	box of 100
23919	Auto lancet device - AST method	-
23929	Mission printer**	-
33250	Thermal paper roll 57 mm x 25 m	box of 5

\*Safety lancets      \*\*Includes 1 paper roll, cable, adaptor

# MISSION® PT/INR COAGULATION MONITORING SYSTEM

## • 23926 PT/INR COAGULATION MONITORING SYSTEM

Coagulation testing for professional and self use

### Reliable

- quick results for Prothrombin Time (PT) in seconds and International Normalized Ratio (INR)
- large INR range of 0.7-7.0
- individually packed strips with 24 months shelf life
- external optional printer available for quick printing of results
- clinical accuracy: ISO 17593 compliant

### Simple operation

- results in about 2 minutes
- requires only a single drop of capillary blood or 15 µL of venous whole blood
- insert strip, apply specimen and read results

### User friendly

- handheld portable meter easy to use and ideal for physician offices and home testing
- patients ID, password protected results
- operates with 4AA batteries or standard AC adaptor



23926 CE 0123

GIMA code	ACCESSORIES AND SPARES	Minimum order
23927	PT test strips with chip	box of 12
23928	PT test strips with chip	box of 48
23931	Control solution	1 kit**
24515	Surgilance safety lancets 22G	box of 100
33250	Thermal paper roll 5.7 cm x 25 m	box of 5
23929	Mission printer* - need cable 23930	
23930	Cable printer to PT/INR	23929

\*Supplied with 1 paper roll, adapter, package insert  
\*\*Includes 5 level-1 and 5 level-2 0.4 ml bottles, 1 insert, 1 plastic clamp



STANDARD ACCESSORIES		
1 quick reference guide	1 AC adaptor	4 AA batteries
1 carrying case	1 user manual (GB, IT) on request DE, ES, PT	
TECHNICAL SPECIFICATIONS		
Methodology	Optical fluorescence	
Time to results	About 2 minutes	
Memory	200 results with date/time	
Specimen volume	15 µL	
Specimen type	Fresh capillary or venous whole blood	
INR measurement range	0.7-7.0	
HCT range	25-60 %	
Precision	Repeatability and total precision <10%	
Accuracy (capillary whole blood)	Y=1.076X-0.078, R=0.924	
PC interface	Mini USB	
Power source	4 AA batteries or AC adaptor	
Battery life	>100 tests	
Meter dimension (LxWxH)	152x72x38 mm (6.0"x2.8"x1.5")	
Display dimension (LxW)	53x29 mm	
Weight excluding batteries	170 g (6.0 oz)	

# LUX: PROFESSIONAL MONITORING OF LIPIDS AND HEMOGLOBIN



23983

CE 0344

TOTAL CHOLESTEROL

HDL

LDL

\*calculated value

TRIGLYCERIDES

HEMOGLOBIN

MADE IN ITALY

\*CHOL/HDL & LDL/HDL ratio calculation

## • 23983 LUX MONITOR for lipid and hemoglobin

The cardiovascular diseases are linked to the concentration of cholesterol in the blood. Many people don't know that their cholesterol is high or do not monitor it. Lux gives benefit to doctor to do a complete lipid screening plus hemoglobin in less than 3 minutes.

### Easy

Only 45 µL for the complete lipid panel, 7 µL for the hemoglobin.

### Effective

Doctor can test during consultation with patient.

### Complete lipid panel in 3 minutes

Measurement of cholesterol, triglycerides, HDL, LDL at the same time in less than 3 minutes.

### Additional hemoglobin

### Software for download PC (GB, IT)

Optional data reading software (CD + cable) for easy download.

Lux monitor is supplied with carrying bag, pipette 15 µL, pipette 7 µL, 3xAAA batteries 1.5 V and manual (GB, IT, ES).

Minimum software requirements: Windows 7.

GIMA code	ACCESSORIES AND SPARES	Minimum order
23984	Lipid strips with tips and chip - use with 23997	box of 10
23985	Hemoglobin strips with tip and chip - use with 23998	box of 10
23987	Lipid control solution with chip - 2 ml	3 bottles**
23988	Hemoglobin control solution - 2 ml	1 bottle
23996	Disposable tips for pipettes	bag of 50
23997	Pipette 15 µL for lipid - spare for 23984	-
23998	Pipette 7 µL for hemoglobin - spare for 23985	-
23999	Software (CD + cable)	-

\*\*1 bottle for each parameter (total cholesterol, triglycerides, HDL)

TECHNICAL SPECIFICATIONS - STRIPS	
Measuring method	Photometric
Test range	Total Cholesterol: 100-400 mg/dL, Triglycerides: 50-600 mg/dL, HDL: 20-80 mg/dL, Hemoglobin: 5-25 g/dL
Measuring unit	mg/dL (standard), mmol/L (settable by user)
Measuring time	Lipids: within 3 min.; Hemoglobin: 5 sec.
Sample volume	15 µL Cholesterol, Triglycerides, HDL each test; 7 µL Hemoglobin 45 µL Lipid 3 tests;
Type of sample	Lipids and Hemoglobin: fresh capillary blood for self-monitoring and professionals (venous blood samples must be withdrawn by a healthcare professional)



23984



23985



23997



23998

TECHNICAL SPECIFICATIONS LUX MONITOR	
Battery life:	More than 500 measurements (lipid) or more than 1'000 measurements (hemoglobine)
Method of measurements	optical method
Display	LCD (LED Backlight)
Operation buttons	3 buttons (ON/OFF switch, up button and down button)
Memory	1'000 readings
Power source	3XAAA 1,5 V alkaline manganese batteries

## LACTATE SCOUT 4: PROFESSIONAL LACTATE MEASUREMENT

### 23992 LACTATE SCOUT 4

Ergonomic device for fast, accurate and reliable lactate measurement.

#### Easy to use:

- only 0.2 µl of capillary blood required
- pre-calibrated sensors
- device calibrated by simple coding
- lactate measurement, date/time, mode, temperature, heart rate and memory ID on a single display

#### Fast and accurate:

- enzymatic amperometric detection method
- results within 10 seconds
- measuring range: 0.5 - 25 mmol/L (±3%)

#### Performance measurement:

- single and step-test measurements (resting/exercise/recreation)
- stopwatch and countdown timer functions
- connection to heart rate monitors for linking to lactate value

#### Integrated bluetooth technology and PC software:

An USB key allows easy transfer to PC and a 4 language (GB, DE, IT, ES) software allows easy data management. Supplied with nylon bag, empty spray bottle, Bluetooth module, USB key with software and manual (GB, FR, IT, DE, ES, NO, SE, CZ, GR, NL, PL, TR).

#### 23991 STRIPS - tube of 24 pcs

#### 24513 SURGILANCE SAFETY LANCETS 26G - sterile - box of 100

Stores over 500 results

1000 tests using just 2xCR2450 batteries

E-paper display for easier viewing on the move



CE 0123

Pocket size: 91x46x21 mm  
Weight: 60 g

Multilingual box: GB, FR, IT, ES, DE

23992

Integrated Bluetooth low energy connectivity

Easy handling in 3 steps

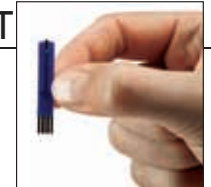

Remove sensor and place into analyzer



Prick finger and collect blood by touching sensor



Results appear in 10 seconds

## HEMO CONTROL: HEMOGLOBIN MEASURER AND HEMATOCRIT

### 23994 HEMO CONTROL

Fast, simple and accurate determination of hemoglobin and hematocrit in whole blood:

- two tests in one
- fast results in 25 to 60 sec
- limited sample volume 8 µl
- graphical touch screen
- no calibration required, automatic self test
- memory: 4,000 results including date and time
- Hb con-low, Hb con-norm, Hb con-high
- integrated rechargeable battery (100 hours)

#### 23995 HEMOGLOBIN MICROCUVETTES - box of 50

#### 24513 SURGILANCE SAFETY LANCETS 26G - sterile - box of 100

MADE IN GERMANY

Compact size only  
160x160x68 mm  
Weight: 700 g



23994

Large illuminated graphical touch screen for intuitive device handling

Supplied with transformer (to recharge battery), control cuvette and kit for cleaning, English manual, CD manual (GB, FR, IT, DE, ES, PT, PL, RU)

Easy handling in 3 steps



Collect 8 µl blood sample



Put microcuvette into analyzer



Read results on display in 25-60 sec

TECHNICAL SPECIFICATIONS	
Measurement method:	photometric, azidemethemoglobin
Measuring range:	0 - 25.6 g/dL; 0 - 15.9 mmol/L
Sample volume:	8 µl
Sample material:	venous, arterial or capillary blood
Precision:	<2%
Linearity:	0 - 20 g/dL ±0.3 g/dL >20 g/dL ±0.7 g/dL
Calibrated to NCCLS standard	
Operating power:	110-250 V - 50/60 Hz; integrated battery (approx 100 h use)

## MISSION Hb HEMOGLOBIN TESTING SYSTEM

### 24022 MISSION Hb HEMOGLOBIN TESTING SYSTEM

Accurately detects Hb and Hct levels. Professional use.

#### Quick

- Hemoglobin (Hb) and Hematocrit (Hct) results in < 15 seconds
- simply insert strip, apply specimen and read results
- features auto-calibration
- no specimen preparation required

#### Accurate

- only 10 µL capillary or venous blood required
- precise results equivalent to automatic hematology analyzers
- wide Hb measurement range of 4.5-25.6 g/dL with Hct range of 13-75%
- stores up to 1,000 results

#### Portable

- operated by battery
- handheld for immediate diagnosis
- dry strips eliminate inconvenience in shipping and storage of liquid reagents

#### Convenient

- can test capillary and venous whole blood
- minimal training required
- quick data transfer via Mini USB port



Large LCD 39x37 mm

CE

PROFESSIONAL USE

24022

Multilingual box: GB, FR, IT, ES, PT, DE, PL, RO, SE, FI, GR, TR, Arabic.

#### 24023 TEST STRIPS - box of 50 + 1 code chip

#### 24027 CONTROL STRIPS - box of 2

#### 24024 CAPILLARY TRANSFER TUBES 10 ml - plastic - box of 50

#### 23916 GIMA LANCETS 28G - sterile - box of 100

#### 24513 SURGILANCE SAFETY LANCETS 26G - sterile - box of 100

#### 23919 AUTO LANCETS DEVICE - AST method

TECHNICAL SPECIFICATIONS	
Methodology	reflectance Photometry
Detection	principle Methemoglobin
Time to results	< 15 seconds
Memory	1,000 tests with date/time and ID number
Specimen volume / type	10 µL / capillary and venous whole blood
Hb measurement range	4.5 - 25.6 g/dL Hct range 13 - 75%
Wavelengths	525 nm
Calibration	automatic
Hb within run precision	≤ 3% Hb Total precision CV ≤ 3%
Accuracy	Hb 4.5 - 10 g/dL, ±0.4 g/dL; Hb 10 - 25.6 g/dL ± 4%
Power source	3 AAA Batteries or AC Adaptor on request
Battery life	2,700 tests or 360 hours
Automatic shut off	8 minutes
Size (LxWxH)	127x58x25 mm (5.0"x2.28"x0.09")

STANDARD ACCESSORIES		
10 test strip	1 code chip	3 AAA batteries
10 lancets (26 G)	2 control strips	1 carrying case
1 lancing device	10 capillary transfer tubes - plastic	user manual GB, IT

## INFLUENZA A/B TESTS

• **24537 INFLUENZA A/B TESTS - box of 30 tests (3 packs of 10 pcs.)**

Influenza A/B is a rapid in vitro test to detect type A and B influenza antigens (nucleoprotein) extracted from the nasal specimens.

The test is designed to detect nucleoproteins of Flu-A core subtypes, independent of H and N surface proteins (including H1N1, H3N2, H5N1, H5N3, H7N3, H9N2).

A sterile nasal swab allows an easy collection of specimen. Results in 10-15 minutes.

Includes rapid influenza A/B test panel, swab, test tube, extraction buffer.

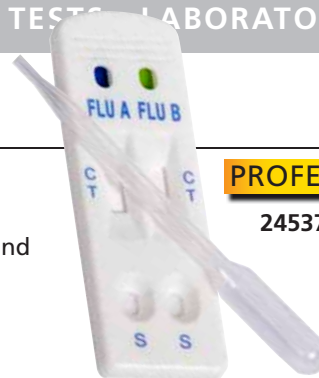

**PROFESSIONAL**

24537



## HELICOBACTER PYLORI TEST FOR ULCER SCREENING

• **24528 HELICOBACTER PYLORI TEST - box of 40 tests**

24529

Helicobacter Pylori is the leading cause of gastric ulcers, this easy to use test allows a quick diagnosis in about 10 minutes.

Easy to perform and interpret. Whole blood/serum/plasma.

Includes 40 test devices, 40 droppers, 1 buffer.

Diagnosis of H. pylori infection in adults over 18 years of age.

For professional use.

• **24529 HELICOBACTER PYLORI SELF TEST - box of 1 test**

Packed in single box including one automatic lancet, single buffer and user manual. This product is provided with self testing certification to be sold to end users in OTC market.

No additional equipment required.

**SELF TEST**



Multilingual manual and box: GB, FR, IT, GR

**PROFESSIONAL**



0197

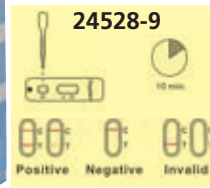

24528

## PROSTATE SCREENING - PSA ONE-STEP TEST

• **24533 PSA TEST - box of 25 tests - for professional use**

The PSA is a rapid test cassette for semi-quantitative detection of prostate specific antigen, that utilizes a combination of colloidal gold conjugate and anti-PSA antibodies.

Provides accurate results in 5 minutes.

- sensibility, specificity and accuracy 99%
- detects PSA in whole blood, serum or plasma
- cut-off from 3 ng/ml.



Tests are supplied with droppers, buffer, multilingual instructions (GB, FR, IT, ES).

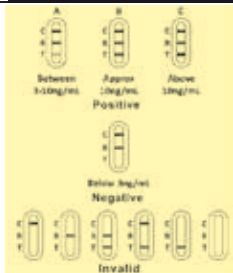

24533

**PROFESSIONAL**

## CARDIAC MARKER

• **24525 CARDIAC MARKER**

**3 parameters: CK-MB, Troponin, Myoglobin - box of 20 tests**

It allows to check cardiac status and stroke events in just 15 minutes. Ideal to keep under control patients affected by cardiopathies or after heart attack or surgery.

Acute Myocardial Infarction-MI (Heart Attack) is responsible for 1 in 5 deaths in the U.S. After 6 hours of AMI onset, the damage to the cardiac muscle is irreversible and permanent.

This illustrates that early and accurate diagnosis of AMI is essential. ECG is the most widely used method of MI diagnosis.

Unfortunately, as many as 25% of AMI patients have a normal

ECG. GIMA offers an array tests for Biochemical and Protein markers of MI, such as Creatine Kinase Isoenzyme MB (CK-MB), Myoglobin (MB) and Cardiac Troponin I (cTnI) in combination.

It includes 20 droppers, 20 cassettes.

Measurement in plasma, serum or whole blood.

Multilingual manual (GB, FR, IT, ES.) For professional use.

**PROFESSIONAL**



## SEMI-QUANTITATIVE CRP TEST

• **24527 CRP TEST - box of 20 tests**

Measurement of CRP in whole blood, plasma or serum has two purposes:

- 1) hs-CRP levels help in assess the risk of cardiovascular and peripheral vascular disease. Higher hs-CRP values have highest risk of cardiovascular disease.
- 2) CRP levels help identify and keep track of infections and diseases that cause inflammation (lymphoma, lupus, giant cell arteritis, osteomyelitis, rheumatoid arthritis, .....).

- use fingerstick whole blood or serum/plasma
- results within 7 minutes
- room temperature storage
- built in performance control and reference band

It includes 20 cassette tests with droppers. For professional use.



24527

Strong intensity colour bands

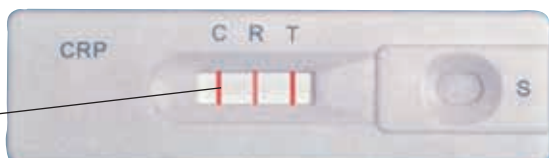

## MALARIA RAPID TEST

• **24547 MALARIA RAPID TEST - box of 40 tests**

A rapid chromatographic immunoassay test for the qualitative detection of circulating plasmodium falciparum in whole blood.

Compared with traditional thick or thin blood smears microscopic analysis, the correlation between the two systems is over 99,0%.

Package includes test devices, buffer, disposable specimen dropper and multilingual manual (GB, FR, IT, ES), lancets are not included.

For professional use.



24547

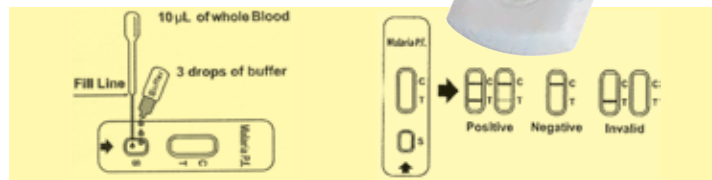

**WARNING: SHORT EXPIRY DATE FOR TESTS.** Tests have 24 months expiry at production time. Our stock may vary from 10 to 22 months.

## STREP-A RAPID TEST, ACCURATE RESULTS IN 5 MINUTES

- 24522 STREP-A - device - box of 20 tests
  - 24523 STREP-A - strip - box of 25 tests
- Provides accurate results in few minutes, with a simple procedure easy to perform and to interpret. Immediate diagnosis allows fast patient treatment. Reagents are stable for the duration of the shelf life even after opening. Room temperature storage. It includes 20 devices or 25 strips tests (single pack), 2 reagents, 20 (or 25) tubes and swabs.



	24523	24522
Relative sensitivity:	97% (91-99%)	94% (88-98%)
Accuracy:	95% (93-97%)	97% (96-98%)
Relative specificity:	95% (92-97%)	98% (96-99%)

5 min.

**PROCEDURE**

**24522**

- add 4 drops Reagent A, then drops reagent B
- rotate swab 10 times, wait 1 minute, then remove swab while squeezing tube to remove liquid
- place dropper tip to top of tube (24522)
- add 3 drops of specimen (24522)
- immerse strip in specimen (24523)
- read results after 5 minutes

**24523**

Positive Negative Invalid



## STREP-A DUAL COLOUR RAPID TEST, OPTICAL TECHNOLOGY

- 24519 STREP-A DUAL COLOUR TEST - strip - box of 50 tests
- Dual colour rapid test for Strep A uses the antibody labelled colour particles coated at two separate locations in the test device. Optical immunoassay technology allows greater sensitivity and less false negative results without affecting specificity. The procedure for the user is the same as for the standard test but the result will be easier to view. If Group A Streptococcus is present in the sample, a visible **blue Test Line** will appear to indicate a positive result and a **red Control Line** will also appear to indicate the test is valid. Kit includes 50 test strips, 50 tubes, 50 swabs, 2 reagents and 2 control solutions.



	24519
Relative sensitivity:	95.1% (95%CI: 89.6-98.2%)
Relative specificity:	97.8% (95%CI: 95.8-99%)
Overall accuracy:	97.1% (95%CI: 95.3-98.4%)

Blue test line indicates a positive result, red control line indicates test validity

## COVID-19 (SARS-CoV-2) ANTIBODY TEST

- 24536 COVID-19 (SARS-CoV-2) ANTIBODY TEST - box of 20
- Professional qualitative test intended for the detection of antibody content against COVID-19 in clinical samples (serum/plasma/whole blood). It offers high accuracy, efficiency in providing results in 15 minutes and convenience for its suitability to finger blood. Room temperature storage.
- IgG and IgM, three lines - finger blood: 20µl
  - serum/plasma: 10 µl
  - 12 months shelf life (average Gima shelf life: 4 to 10 months).
- It includes 20 tests, instructions for use and one lot number card. Each test contains one testing strip, one dropper and one desiccant.

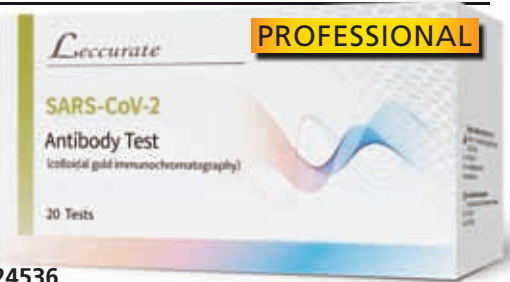

Based on the principle of antigen-antibody reaction and immunoassay technique. It contains colloidal gold labeled COVID-19 recombinant protein, mouse-anti human IgG antibody immobilized in G test area, mouse-anti human IgM antibody immobilized in M test area and the corresponding antibody in C quality control area. Antibodies are secreted after virus invasion: immunoglobulin M (IgM) comes out first, as early sign of infection and immunoglobulin G (IgG) comes later, arising a more specific and stronger reaction to the virus. Sample is positive when purple-red bands appear in C area and in one or both G and M areas. Sample is negative when colored band only appears in C area.

**Operation Steps**

**Step 1:** add 20µl of whole blood sample/ 10µl of serum or plasma sample to well A

**Step 2:** add two drops (about 80µl) of sample dilution to well B and start timing

**Step 3:** the test results should be read within 10-20 min. Do not read the results after 20 mins

C: Quality Control Line  
M: IgM Detection line  
G: IgG Detection line

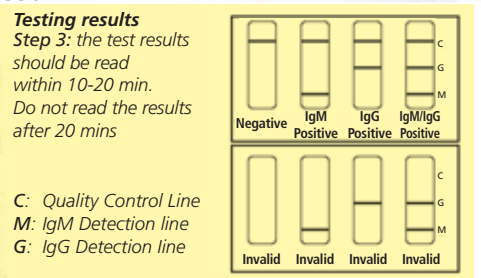

## FOB-FECAL OCCULT BLOOD TEST FOR EARLY DETECTION

- 24530 FOB TEST - box of 25 tests
- Provides accurate results in few minutes. It facilitates early patient treatment decision. Simple procedure, easy to perform and interpret. It includes 25 pcs of collection sticks, device test and one buffer bottle.



# COVID-19 ORAL FLUID ANTIGEN RAPID TESTS

- 24588 SALIVA COVID TEST - self test - box of 1
- 24590 SALIVA COVID TEST - professional - box of 20

The COVID-19 Antigen Rapid Test (Oral Fluid) is a qualitative rapid chromatographic immunoassay for the qualitative detection of SARS-CoV-2 Nucleocapsid (N) protein antigens in oral fluid specimens from individuals with suspected infection. It's a single-use test kit intended to detect the coronavirus SARS-CoV-2 through human oral fluid. This test is designed for self-testing (24588) or professional use (24590). Research shows that the SARS-CoV-2 virus is stable in oral fluid for long periods of time at warm temperatures.

- fast results: 15 minutes
- high accuracy
- convenient procedure
- easy interpretation
- simple operation
- relative specificity: 99,3%

Storage temperature: 2-30°C  
Shelf life\*: 12 months (24588) 24 months (24590).

\*Gima stock may vary from 4 to 10 months (24588) 6 to 22 months (24590)



24588



### STANDARD ACCESSORIES

- |  |  |
|--|--|
| Test devices                                   | Biosafety bag                            |
| Collection devices (funnel, tube and tube tip) | Procedure card (24590 only).             |
| Buffer   | Multilingual box: GB, FR, IT, ES, DE, PT |
| Package insert                                 |  |

<p><b>Step 1: Specimen collection</b> Remove the funnel and plastic tube; fit the funnel onto the tube. Deeply cough 3-5 times. Gently spit oral fluid into the funnel. The oral fluid (non-bubble) should just reach the height of scale line.</p>	<p><b>Step 2: Specimen preparation</b> Add entire buffer to the tube with oral fluid. Fit the tube tip onto the tube. Gently squeeze the tube 10-15 times to mix well.</p>	<p><b>Step 3: Testing</b> Place the test cassette on a flat and level surface. Invert the tube and add 2 drops of solution to the specimen well(S) of the test device and then start the timer.</p>	<p><b>Step 4: Read the results in 15 minutes.</b> Do not interpret the result after 20 minutes. After test is completed, dispose all the components</p>
---	--	---	---

# SARS-CoV-2 ANTIGEN RAPID TEST KIT - PROFESSIONAL

• 24585 SARS-CoV-2 ANTIGEN TEST KIT - box of 25  
Rapid test kit (Colloidal gold immunochromatography) intended for the qualitative detection of SARS-CoV-2 antigen and variants in clinical samples (nasal swab). It includes detection of the United Kingdom and the South African variants, recognizing the N protein on the surface of the virus.

- non invasive, simple to use
- convenient, no device required
- rapid, gets results in 15 min.
- stable, with high accuracy
- inexpensive, cost-efficiency
- storage condition: 4~30°C
- 18 months shelf life since manufacturing date

(average shelf life of Gima stock: 4 to 16 months)  
Kit includes 25 test cards, 25 nasal swabs, both individually packed and 25 single-dose dropper of diluent solution (3 ml).  
Multilingual instructions: GB, IT, ES, PT, DE, RU.



- Hospital
- Test site
- Mass Screening
- Station
- Airport
- Hotel
- Corporation



Agreed by European Commission Health Security Committee on February 17, 2021

Testing results	Positive (+)	Negative (-)	Invalid
C: control line			
T: test line			

	Positive (+)	Negative (-)
Diagnostic specificity	92.00% (95%CI: 83.63-96.28%)	99.26% (95%CI: 95.92-99.87%)

<p><b>Operation Steps</b> Step 1: use swab to collect sample</p>	<p>Step 2: peel off adhesive</p>	<p>Step 3: insert swab from well B to well A</p>	<p>Step 4: A) add 6 drops B) rotate the shaft, two rounds each direction.</p>	<p>Step 5: fold left side over, and wait for 15 minutes</p>
--	----------------------------------	--	---	---

# SARS-CoV-2 ANTIGEN RAPID TEST KIT - SELF TEST

• 24583 SARS-CoV-2 ANTIGEN TEST KIT - box of 1  
Rapid, lateral flow immunoassay test intended for self qualitative detection of SARS-CoV-2 nucleocapsid antigens with nasal swab. Self-collection must be always carried out by an adult. This test is intended for use in individuals with symptoms or other epidemiological reasons to suspect a COVID-19 infection. The diagnostic sensitivity and diagnostic specificity of the product is 95.9% (90.8-98.2%) and 100% (96.3-100.0%) respectively. Kit includes: 1 test card, 1 nasal swab, 1 single-dose dropper; operation card and instructions GB, IT.

- non-invasive: 2-3 cm insertion
- rapid, gets result in 15 mins.
- stable with high accuracy
- inexpensive

Testing results	Positive (+)	Negative (-)	Invalid
C: control line			
T: test line			

Solid line    Faint line



24583

Test paper tray in the back to place the strip to be tested

## GIMA URINE ANALYZER AND URINE STRIPS

### • 24046 GIMA URINE ANALYZER

Gima urine analyzer is a high-precision instrument with advanced technologies for clinical inspection of urine. It offers easy and quick operation, exact results and good repeatability. Features:

- high-luminance, white LED, features long life and good stability
  - large LCD display
  - user-friendly interface
  - monitoring the whole testing process, and audible-control prompt
  - data transmission function.
- Application:
- convenient point of care testing for doctor
  - chronic diseases, long-term monitoring for nephrotic patients
  - health examination
  - use as telemedicine terminal.

### Tested parameters

Glucose (GLU), Bilirubin (BIL), Specific gravity (SG), PH, Ketone body (KET), Occult blood (BLD), Protein (PRO), Urobilinogen (URO), Nitrite (NIT), Leukocytes (LEU), Ascorbic acid (VC). Can be used only with Urinalysis strips 24076.

### PHMS App

Free App to save data, check report and results. Multilingual manual and box: GB, FR, IT, ES.

Download PHMS App on



24046



### TECHNICAL SPECIFICATIONS

Working mode:	One-step
Internal language:	Italian and English
Display:	2.4" LCD, resolution: 320x240
Data storage:	500 sample data
Principle:	RGB tricolor test theory
Communication interface:	Micro USB interface, Bluetooth wireless communication
Repeatability:	CV ≤1%

Stability:	CV ≤1%
Record mode:	LCD display, flash ROM data storage
Power supply:	Built-in rechargeable lithium battery 3.7 V, 1800 mAh
	Host computer: DC 5 V, 1 A
	Adapter: AC 100-240 V, 50/60 Hz
Test range:	Refer to grads table on www.gimaitaly.com
Dimension - Weight:	126x73.5xh 30 mm - 0.18 kg

## GIMA URINE SCREEN VISUAL STRIPS

### • 24073 10 PARAMETER STRIPS - tube of 100 strips

### • 24074 11 PARAMETER STRIPS - tube of 100 strips

These strips can be used by professionals for visual tests Global check/screening for general health condition. For use in preliminary screening tests for diabetes, liver diseases, hemolytic diseases, urogenital and kidney disorders and metabolic abnormalities.

Multilingual box: GB, FR, IT, ES, PT, DE, NL, GR, NO, SE, FI, DK, RU, CZ, PL, TR, BG, MT, HU, HR, RO, SK, SL, LV, LT, GA, ET and instructions: GB, FR, IT, ES, PT, DE, NL.

All other European languages instructions available on [www.gimaitaly.com](http://www.gimaitaly.com).



PROFESSIONAL USE



GIMA URINE SCREEN		
Parameters	24073	24074
Glucose	•	•
Ascorbic Acid		•
Ketones	•	•
Protein	•	•
pH-Value	•	•
Blood	•	•
Nitrite	•	•
Leucocytes	•	•
Spec. Gravity	•	•
Bilirubin	•	•
Urobilinogen	•	•

## URINALYSIS VISUAL STRIPS

### • 24076 10 PARAMETERS STRIPS - tube of 100 strips

Urinalysis strips can be used by professionals for medical organization testing and analysis of urine specimen with visual results. Strips can also be examined with Gima urine analyzer (24046).

- anti-VC interference ability;
  - global check/screening for general health condition;
  - rapid results: from 30 to 120 seconds;
  - high quality colours chart;
  - cut-off value measures for each parameter.
- Multilingual instructions: GB, FR, IT, ES

URINALYSIS VISUAL STRIPS		
Parameters	Testing and reading time (s)	Cut-off value
Glucose	30 s	2.8 ~ 5.5 mmol/L
Ketone	40 s	0.5 ~ 1.0 mmol/L
Protein	60 s	0.15 ~ 0.3 g/L
pH-Value	60 s	0.5
Blood	60 s	5 - 15 Ery/μL
Nitrite	60 s	13 ~ 22 μmol/L
Leucocytes	120 s	5 - 15 Leuko/μL
Specific Gravity	45 s	0.005
Bilirubin	30s	8.6 - 17 μmol/L
Urobilinogen	60 s	3.3 - 16 μmol/L

PROFESSIONAL USE



24076





# ANALYTICON URILYZER® 100 PRO URINE ANALYZER

• **24049 URILYZER® 100 PRO URINE ANALYZER - with printer**  
 Urilyzer® 100 PRO is a semi-automated and compact urine test strip reader that offers a broad range of optimized features. The intuitive user interface improves data entry and allows manual entry of colour and turbidity from a predefined list or by an additional comment. Moreover, the system provides the user with a high level of customization with flexible testing and reporting options. The intelligent database-driven data management provides multiple filter options. To be used with urine strips 24056, 24057, 24058, 24062, 24063, 24064 only. Manual GB, FR, IT, ES. Other languages available on [www.analyticon-diagnostics.com](http://www.analyticon-diagnostics.com) GB, FR, IT, ES, DE, SE, DK, NL, CZ, PL, BG, RO, RU, LT, NO. Internal software: GB, FR, IT, ES, DE, GR, NO, SE, FI, DK, HU, CZ, PL, RO, RU.

• **33250 PRINTER PAPER 57 mm x Ø 50 mm - box of 5 rolls**

• **24055 CONTROL SOLUTION - 15 ml - box of 2**  
 Open vial stability (at 2-8°C) of 75 days or 20 determinations (whichever occurs first)

• **24048 STRIP HOLDER TRAY - spare**

**Measurements:** 50 meas./hour in normal mode, 120 meas./hour in fast mode  
**Memory:** 3,000 patient test results and 1,000 QC Test results  
**Display:** 3.5" QVGA Touch-screen LCD (resolution 240x320)  
**Printer:** Low noise thermal printer with paper roll for about 280 meas  
**Printout:** Current number measurement, Date and time, Serial No. of the meter, patient-I-D, Asterisk on pathological results, Parameters can be printed in SI, Conventional or arbitrary units



MADE IN HUNGARY

Touch screen intuitive interface

24049

Easy, clean and safe automatic start of measurement by strip detection

GERMAN TECHNOLOGY AND ACCURACY

### TECHNICAL SPECIFICATIONS

**Accuracy:** Meter adjustment in 5 levels according to individual requirements  
**Type:** Reflectance photometer wavelengths: 505, 530, 620, 660 nm  
**Interfaces:** RS232 serial port, USB A, USB B, PS2 (external keyboard, barcode reader). Ethernet port, HL7 protocols LIS2 (ASTM+), HL7, POCT1 A2  
**Size - weight:** 208x290x80 mm (WxDxH) / 1.2 kg  
**Power supply:** 100-240 V, 50-60 Hz

# ANALYTICON COMBISCREEN® PLUS AND CLASSIC URINE TEST STRIPS

Urine strips for visual test or for use with Urilyzer® 100, 100 Pro, 500 Pro and Combiscan 100 (24056\*-8\*, 24062-4 only) *\*Not suitable for 500 Pro and Combiscan*  
 - excellent ascorbic acid protection on glucose  
 and blood test pads offers relevant reduction of false negatives due to interference with ascorbic acid (only CombiScreen® Plus)  
 - high quality water resistant label made with real colour printing guarantees an exact visual evaluation  
 - distinct colour changes in the clinically relevant range even at low concentration level  
 - easy to use: results can be read directly on the strip after about 60 seconds (up to 120 for Leucocytes) and compared with the label on the bottle. Supplied in alluminium tube in single cardboard box. For professional use.



MADE IN GERMANY

COMBISCREEN® PLUS with ASCORBIC ACID PROTECTION

Urine test strips with ascorbic acid protection on glucose and blood test pads



ANALYTICON URINE STRIPS		
GIMA code	COMBISCREEN® PLUS URINE STRIPS with ascorbic acid protection	Minimum order
24057	CombiScreen® 5SYS Plus - 5 parameters	tube of 100
24058	CombiScreen® 7SYS Plus - 7 parameters	tube of 100
24059	CombiScreen® 9+Leuko Plus - 9+1 parameters	tube of 100
24061	CombiScreen® 10SL Plus - 10 parameters	tube of 100
24063	CombiScreen® 11SYS Plus - 11 parameters	tube of 100
24064	CombiScreen® 11SYS Plus - 11 parameters	tube of 150
COMBISCREEN® CLASSIC URINE STRIPS without ascorbic acid protection		
24068	CombiScreen® 10SL - 10 parameters	tube of 150
24062	CombiScreen® 11SYS - 11 parameters	tube of 150
COMBISCREEN® mALB/CREA*		
24056	CombiScreen® mALB/CREA for microalbuminuria	tube of 25

GIMA code	COMBISCREEN® PLUS						COMBISCREEN® CLASSIC	
	24057	24058	24059	24061	24063	24064	24068	24062
Parameters	5SYS	7SYS	9+Leuko	10SL	11SYS	11SYS	10SL	11SYS
Glucose	•	•	•	•	•	•	•	•
Ascorbic Acid								
Ketones		•	•	•	•	•	•	•
Protein	•	•	•	•	•	•	•	•
pH-Value		•	•	•	•	•	•	•
Blood	•	•	•	•	•	•	•	•
Nitrite	•	•	•	•	•	•	•	•
Leucocytes	•	•	•	•	•	•	•	•
Spec. Gravity				•	•	•	•	•
Bilirubin			•	•	•	•	•	•
Urobilinogen			•	•	•	•	•	•

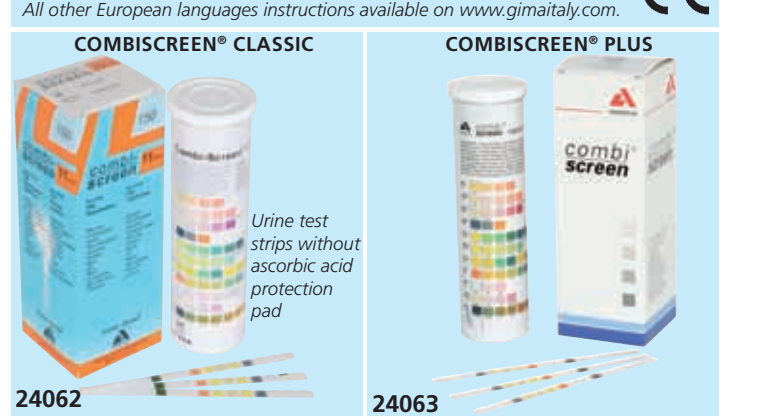

24061

Box all European languages. Instructions: GB, FR, IT, ES, PT, DE, NL. All other European languages instructions available on [www.gimaitaly.com](http://www.gimaitaly.com).

COMBISCREEN® CLASSIC

COMBISCREEN® PLUS

Urine test strips without ascorbic acid protection pad

24062

24063

## DRUG TEST READER SYSTEM - FOR URINE DRUG CUPS/PANELS

- 24570 DRUG READER - Italian software
  - 24576 MULTI DRUG CUP - 7 drugs + S.V.T.
  - 24577 MULTI DRUG CUP - 8 drugs + S.V.T.
- Simply scan one of the two multi drug tests on drug reader and get a complete analysis on your PC.
- automatic analysis of "visual read" test panels
  - automatic test menu recognition (2D barcode)
  - in-process system quality control check
  - image capture, data management/export functionality, archived results
- Main benefits:
- automation: eliminates results interpretation variability/subjectivity
  - accurate: performance advantages vs. visual interpretation
  - speed: scanning process requires 15-30 sec.
  - flexible: semi-portable, simple installation, Windows 7, 8, 10 compatible. Professional use.

DRUG	24576	24577	CUT OFF NG/ML	Detection time
MTD	•	•	300	5-7 days
MDMA	•	•	500	5-7 days
MET	•	•	500	3-5 days
COC	•	•	300	2-5 days
THC	•	•	50	-
AMP	•	•	500	2-5 days
MOP	•	•	300	5-7 days
BUP	•	•	10	5-7 days
S.V.T.				
OX		•		
S.G.		•		
PH		•		
NiT		•		
Glut		•		
CRE		•		



Ideal for occupational medicine for cost effective workers screening



## MULTI DRUG "CUP" TEST - PROFESSIONAL

- 24546 MULTI DRUG "CUP" TEST - urine box of 25 tests for 7 drugs
- Detects following parameters: (MTD/MDMA)+<COC>+<AMP500>+<MET500>+<THC>+<MOP>.
- easy to use: no urine handling, just insert the key into the active test and read results in 5 min.
  - tightly sealed urine cup: no leaking or spilling of urine specimen
  - unique design: ensures that urine used in the test, is separated from residual urine, that will remain uncontaminated, to be used for a further test
  - key packed separately to ensure that only technician can take the test.

Manual: GB, IT Test panel is tightly fastened to the cup, protecting it from contamination

DRUG	CUT OFF NG/ML	DETECTION TIME*
MOP	300	5-7 days
COC	300	2-5 days
THC	50	-
AMP	500	2-5 days
MDMA	500	5-7 days
MTD	300	5-7 days
MET	500	3-5 days

\*Drug use over detection time not measured



## MULTI-DRUG (6 DRUGS - 8 PARAMETERS) MIDSTREAM SALIVA RAPID TEST

- 24566 MULTI DRUG SALIVA MIDSTREAM TEST - box of 20 tests
- A multi parameters, all-in-one test for simultaneous detection of 6 different drugs in 10 minutes. Cost effective system for the screening of workers for illicit substance consumption. Professional use. Multilingual box and manual: GB, FR, IT, ES.

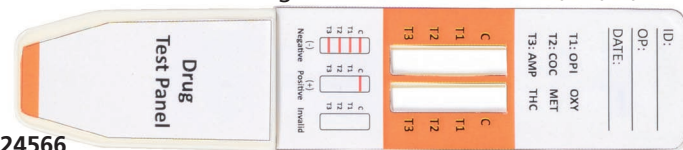

24566

Drug test	Parameters	Cut-off (ng/ml)
Opiates (OPI/MOP):	Morphine	40
	6-Monoacetyl/morphine	4
Cocaine (COC):	Benzoylcegonine	30
Amphetamine (AMP):	d-Amphetamine	40
Oxycodone (OXY):	Oxycodone	40
Methamphetamine (MET):	d-Methamphetamine	40
	3, 4-Methylenedioxy-methamphetamine (MDMA)	50
Marijuana (THC):	11-nor-Δ9-THC-9 COOH	10

## DRUGS OF ABUSE, URINE TESTS FOR PROFESSIONAL USE

- 24540 COCAINE TEST - strip - urine - cut-off: 300 ng/ml
  - 24541 MARIJUANA TEST - strip - urine - cut-off: 50 ng/ml
  - 24542 OPIATES TEST - strip - urine - cut-off: 2.000 ng/ml
- Codes 24540-41-42 are sold in box of 50 strips individually packed in single pouch.

CE 24540-41-42

- 24550 MULTI DRUG PANEL TESTS - urine box of 25 tests for 6 drugs\*
- 24549 MULTI DRUG PANEL TESTS - urine box of 25 tests for 8 drugs\*\*
- 24551 MULTI DRUG PANEL TESTS - urine box of 25 tests for 12 drugs

24550



Accurate results in 5 min. on the following drugs: amphetamine\*, cocaine\*, marijuana cannabis\*, methamphetamine\*, opiates\*, phencyclidine\*, barbiturates, benzodiazepines, ecstasy, morphine300, methadone, tricyclic antidepressants.

\*Code 24550 contains tests for drugs with asterisk

\*\*Code 24549 contains tests for drugs with asterisk plus MDMA and 6-AM.

Cut-off levels meet SAMHSA guidelines.

Manual: GB, FR, IT, ES, DE, PT, GR, Arabic.



Drug	SCREENING TEST PANEL			Detection time
	24550	24549	24551	
MOP	-	-	300	5-7 days
COC	150	150	150	2-5 days
THC	50	50	50	5-8 days
AMP	500	500	500	2-5 days
MDMA	-	500	500	5-7 days
MTD	-	-	300	5-7 days
MET	500	500	500	3-5 days
BZO	-	-	300	7-10 days
BAR	-	-	300	2 days - 4 weeks
PCP	25	25	25	-
OPI	2000	2000	2000	5-7 days
TCA	-	-	1000	-
6-AM	-	10	-	-

## PROFESSIONAL ALCOHOL TESTER

• 24486 AP338 EASY RECALIBRATION ALCOHOL TESTER with printer

- 24487 PRE-CALIBRATED SENSOR MODULE for 24486 - spare
- 24494 BLOWING TUBES for 24486, 24491 - box of 100 pcs.
- 24495 PAPER ROLLS for 24486, 24491 - box of 10

Professional fuel cell sensor breath alcohol tester with printer and touch screen.

The fuel cell is a porous disk with a thin layer of platinum. Any alcohol that comes in contact with the cell's surface is broken down chemically.

For each broken down molecule of alcohol a given number of electrons are freed.

The numbers of electrons generated are in proportion to the amount of alcohol.

**Self recalibration:** easy replacement of pre-calibrated module. Alcohol tester is supplied with integrated printer, 25 mouth pieces, 1 large mouth piece, power supply 100-240V, 50/60 Hz, carrying pouch, 4 rolls of paper, charger, USB cable, manual GB, IT.



**SELF CALIBRATION**  
with pre-calibrated module



24486

Size: 208x78x37 mm  
Weight: 360 g.

TECHNICAL SPECIFICATIONS	
Display:	Colour 4.5" iPS LCD display
Keyboard:	Navigation key input with touch panel
Power Supply:	Rechargeable 3.7 V Li-ion battery
Warm up:	Chamber & Sensor warm up automatically
Auto flow monitoring:	Automatic flow detection
Operating environment:	-20 to +45°C (optimal 5 to 40°C)
Data download:	USB port
Compatibility:	Windows XP, 7, 8, 10
Memories:	150,000 memories full test driver name, vehicle number, inspector name, test result with print date and time, location, calibration data, ...
Measurement precision:	Standard deviation $\pm 0,025$ mg/L or $\pm 5\%$ of the measurement Drift: typically $< 0,8\%$ of the measurement value/month by replacement of pre-calibrated sensor module
Calibration:	mg/L, mg/100 L, %BAC, ‰BAC
Unit setting:	

\*Can export files as Microsoft Excel documents directly

## BREATH ALCOHOL TESTER

• 24498 ALCOHOL TESTER

Compact device to measure alcohol concentration in your breath. Digital/graphic interface and animation, one-hand operation. ‰ BAC values.

Large display to read exact value of your breath (2 colour backlight).

If the result exceeds alcohol limit, the don't drive logo will appear on display.

Supplied in carton box with 3 blowing tubes  $\varnothing$  7 mm.

Multilingual box and manual: GB, FR, IT, ES, PT

- 24501 BLOWING TUBE - box of 12 pcs.
- 32200 "AAA" BATTERIES - blister of 4 pieces

**SELF MONITORING**

**TECHNICAL SPECIFICATIONS**

- Range: Low & 0 ~ 1.50 ‰ BAC
- Accuracy:  $\pm 0.2\%$  BAC full range under alert level
- Battery: 3 x 1.5V AAA batteries (not included)
- Display: Digital display with 0.01‰ BAC resolution
- Tolerance compensation: Pre-alert function together with bi-colour backlighting
- Breath sampling: about 5 seconds continuous breath sample
- Cycle time: about 20 seconds
- Size: 107x45x25 mm approx.
- Weight: 50 g (without batteries)
- Alert level calibrated: 0.5 ‰ BAC
- Auto power off after 2 minutes



24498



## POCKET ALCOHOL TESTER

• 24499 POCKET ALCOHOL TESTER  
Pocket, easy to use alcohol tester

**POCKET, ONLY 8.5x3x1 cm**



**TECHNICAL SPECIFICATIONS**

- Range: Low & 0.2 ~ 1.5 ‰ BAC
- Accuracy:  $\pm 0.2\%$  BAC at calibrated point (alert level)
- Power input: 2 x 1.5V AAA batteries (not included)
- Display: Digital display
- Tolerance compensation: pre-alert function when close to alcohol limit
- Auto power off: 2 minutes
- Breath sampling with auto flow detect: about 6 sec. continuous breath sample
- Cycle time: about 20 seconds
- Alert level calibrated: 0.5% BAC



## SALIVA ALCOHOL STRIPS

• 24502 SALIVA ALCOHOL TEST STRIPS - box of 25 strips  
GIMA Saliva Alcohol Test Strip is a rapid, highly sensitive test for the determination of relative blood alcohol concentration in saliva specimens.

- results in just 3-5 minutes
- colour chart provides approximate relative blood alcohol concentrations (BAC) from 0.02% to 0.30%
- no instrumentation is required
- saliva testing avoids urine collection
- short expiry date (average 10-22 months)
- professional use

1. Saturate the reaction pad

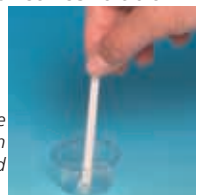

24502



2. Read results in 3-5 minutes



## BIOLOGICAL MICROSCOPES - MAGNIFICATION 40X-1600X

### • 31002 LED BIOLOGICAL MICROSCOPE - 40X to 1600X

- High level microscope with high resolution and transmission
- infinite optical system
- wide field eyepiece WF 10X/20
- infinite semi-plan achromatic objectives 4X, 10X, 40X, 100X
- Abbe condenser
- backward quadruple nosepiece
- double layers mechanical stage (size: 150x139 mm, move range 75x52 mm)
- adjustable brightness
- power supply: switchable 110-220 V, 50 Hz

### • 31000 BIOLOGICAL MICROSCOPE - 40X to 1000X

- 30° compensation free binocular head
- eyepiece 10X (Field 18 mm)
- achromatic objectives 4X, 10X, 40X(S), 100X (S, oil)
- semi plan achromatic objective 40X, 100X, 400X, 1000X,
- interpupillary distance adjustment: from 55 to 75 mm
- mechanical stage, double layers (size: 125x135 mm, move range: 75x35 mm)
- Abbe condenser with iris diaphragm and filter
- halogen lamp 6 V, 20 W - brightness adjustment
- power supply: switchable 110-220 V, 50 Hz
- 31005 SPARE BULB for 31000



**WI-FI MICROSCOPE**  
see page 251

## CENTRIFUGES FOR PLASMA, URINE AND BIOLOGICAL LIQUIDS

### • 24014 ZIP-IQ TT CENTRIFUGE

- 6-place test tube centrifuge for spinning blood, urine and other fluids in 0.5 to 15 ml tubes and microtubes.
- Very small and sturdy unit.
- Speed and time can be adjusted by digital controls.
- Display shows time speed and time remaining.
- Maintenance-free, brushless motor spins at 5,000 rpm (2,500 g) producing serum in as little as 5 min. 2,000 rpm (400 g) to spin urine in 5 min.
- Auto-brake stops rotor in 10 sec. Lid opens automatically upon completion.

- A Lid
- B Rotor
- C "Open" Button
- D Speed Adjustment
- E "Start/Stop" Button
- F Emergency Release Lever (Bottom of unit)
- G Time Adjustment
- H Power Button
- I LCD digital display



### • 24035 XC-2000 CENTRIFUGE

- Very silent centrifuge with 6 tube positions, provided with one touch programming display panel and electronic counter to allow precise speed setting from 1000 to 4000 rpm (500 rpm increments).
- It is supplied with metal holder for 6 tubes of 10 ml and holder for 6 tubes of 15 ml.
- Memory recall of latest operation settings.
- Adjustable operating time: 1 - 60 min.
- Strong ABS structure.
- Automatic shutdown when lid opens.
- User manual: GB, IT.

- 24036 TUBE SHIELD HIGH PROFILE 15 ml for 24035 - spare
- 24034 TUBE SHIELD ADAPTER Ø 13x75 mm for short test tubes
- 24040 TEST TUBES 10 ml - Ø 16x100 mm - box of 100 pcs



### • 24040 TEST TUBES 10 ml - Ø 16x100 mm - box of 100 pcs

RECOMMENDED FLUID SPEEDS AND TIMES				
Fluid	Tube Size	Inserts	Speeds	Times
Blood	Large (6-15 ml)	None or Black	5,000 rpm	5 minutes
Blood	Small (3-5 ml)	White	5,000 rpm	6 minutes
Blood	Microtubes (0.5-2.0 ml)	Green	5,000 rpm	7 minutes
Urine	10-15 ml urine tubes	None	2,000 rpm	5 minutes
Fecals	10-15 ml fecal tubes	None	1,700 rpm	6 minutes

TECHNICAL SPECIFICATIONS	
Speed Range: 300-5,000 rpm (increments of 100)	Output Voltage: 24 V DC, 4 Amps
Maximum RCF: 2,500 g	dBA: 53 ± 3 dBA at 18-24"
Max. Volume: 6, 15ml test tubes	Timer: 15 sec - 99 min
Input Voltage: 100-240 V AC; 50-60 Hz	Size: 212x270xh 158 mm
	Weight: 4.5 kg

STANDARD ACCESSORIES	
6-place angled rotor for 7-15ml tubes	6 green inserts for 0.5-2.0ml microtubes
6 black inserts for 5-6ml tubes	Hex wrench for rotor nut
6 white inserts for 3-4ml tubes	User manual: GB, IT

TECHNICAL SPECIFICATIONS	
Power Supply: 220 V - 50 Hz	
Power: 80 W	
Speed: Approx 1,000 - 4,000 rpm (increased in increments of 500 rpm's)	
Time: 1-60 min	
Dimensions: 320x290xh 320 mm	
Weight: 6 kg	
Capacity: 10 or 15 ml x 6	
Max. RCF: 1,790 g	

# TEST TUBES, MICROTUBES AND PIPETTES

In order to fulfill every laboratory operator's necessity, a wide range of disposable test tubes, microtubes and pipettes is available in different sizes and materials. High quality raw materials, transparency and resistance are the main technical features that characterize these products.



- maximum transparency
- excellent resistance
- accuracy of graduation
- wide range of products

## POLYSTYRENE TEST TUBES WITH OR WITHOUT RIM

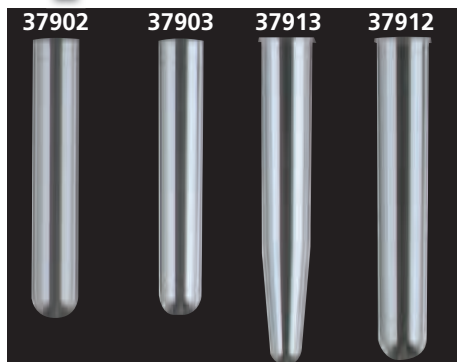

Stoppers in polyethylene, neutral colour



GIMA code	POLYSTYRENE TEST TUBES	Minimum order
<b>TEST TUBES WITHOUT RIM</b>		
37902	Test tube 5 ml - cylindrical - 12x75 mm	box of 4,000*
37903	Test tube 5 ml - cylindrical - 13x75 mm	box of 4,000*
<b>GRADUATED TEST TUBES WITH RIM</b>		
37912	Test tube 10 ml - cylindrical - 16x100 mm	box of 2,000
37913	Test tube 10 ml - conical - 16x100 mm	box of 2,000
<b>WINGED STOPPERS FOR TEST TUBES</b>		
37930	Stopper for tubes Ø 12 mm	box of 1,000
37931	Stopper for tubes Ø 13 mm	box of 1,000
37932	Stopper for tubes Ø 16 mm	box of 1,000

## STERILE TEST TUBES - WITH RED CAP



Versatile test tubes with red caps, which indicate that tubes are sterile. All tubes are provided with writing area. Beta rays sterilization.

GIMA code	STERILE TEST TUBES	Minimum order
<b>POLYPROPYLENE TEST TUBES</b>		
37920	Test tube 5 ml - cylindrical - 12x86 mm	box of 1,500
37921	Test tube 10 ml - cylindrical - 16x100 mm	box of 800
<b>POLYSTYRENE TEST TUBES</b>		
37925	Test tube 5 ml - cylindrical - 12x86 mm	box of 1,500
37926	Test tube 10 ml - cylindrical - 16x100 mm	box of 800

## MICROTUBES

Graduated microtubes made of polypropylene. Flat cap (37941-2 only), one handed usage, neutral colour, frosted area and perfect closure.

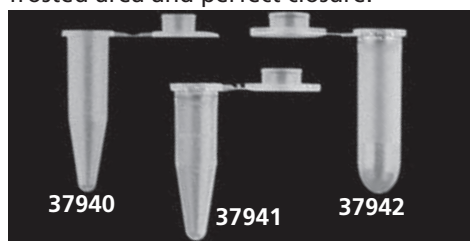

GIMA code	CONICAL MICROTUBES	Minimum order
37940	Microtube 0.5 ml	box of 16,000*
37941	Microtube 1.5 ml	box of 10,000**
37942	Microtube 2 ml	box of 8,000***

\*16 pouches of 1000 \*\* 20 pouches of 500 \*\*\*16 pouches of 500

## TEST TUBE RACKS

- 37935 RACK FOR TEST TUBES Ø 12 AND 13 mm - 90 places - box of 5

Autoclavable, made of polypropylene

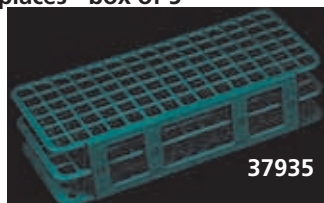

- 37936 RACK FOR TEST TUBES Ø 16 mm - 60 places - box of 5

Autoclavable, made of polypropylene



## PASTEUR PIPETTES

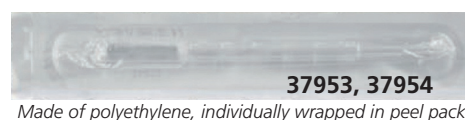
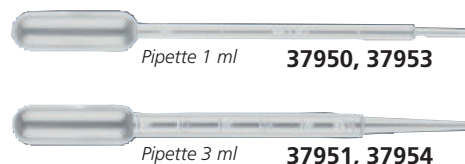

Made of polyethylene, individually wrapped in peel pack

GIMA code	PASTEUR PIPETTE	Minimum order
37950	Pipette 1 ml	box of 5,000*
37951	Pipette 3 ml	box of 5,000*
37953	Pipette 1 ml - sterile	box of 1,000
37954	Pipette 3 ml - sterile	box of 1,000

\*10 boxes of 500 pieces

## CENTRIFUGES TEST TUBES - GRADUATED WITH CAP

All test tubes have a writing area and screw cap

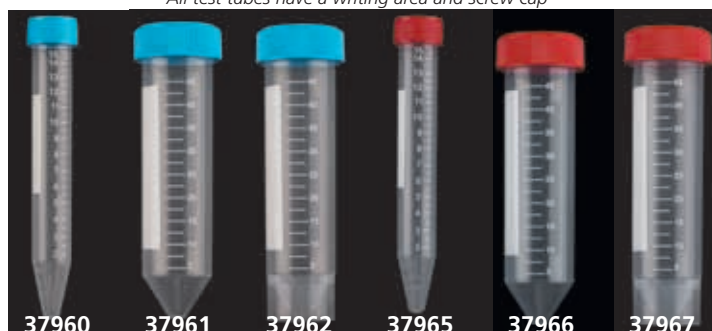

GIMA code	CENTRIFUGES TEST TUBES IN POLYPROPYLENE	Minimum order
<b>TEST TUBES - NON STERILE</b>		
37960	Test tube 15 ml - conical - 17x120 mm	box of 1,700
37961	Test tube 50 ml - conical - 30x115 mm	box of 500
37962	Test tube 50 ml - conical with base*	box of 500
<b>TEST TUBES - STERILE</b>		
37965	Test tube 15 ml - conical - 17x120 mm	box of 1,700
37966	Test tube 50 ml - conical - 30x115 mm	box of 500
37967	Test tube 50 ml - conical with base*	box of 500

\*Size 30x115 mm

## OP-DOP VISOR SHIELD "PROTECTOR" WITH 3+1 SHIELDS

### • 25642 VISOR SHIELD "PROTECTOR" - white

The ultra-light face shield that combines function with style:

**protection:** a waterproof plastic barrier will protect you

**comfort:** fast and easy to wear and remove

**convenience:** reusable and replaceable shield

**optical quality:** superior optical quality.

Medium adjustable size: fits over 90% of healthcare professionals. Fits over glasses.

Shielded air vent eliminates fogging.

Supplied with 3 face transparent shields + 1 head shield.

### • 25643 REPLACEMENT SHIELD KIT

Includes 2 face transparent shields

+ 1 head shield + 1 foam bumper.

MADE IN USA



25643

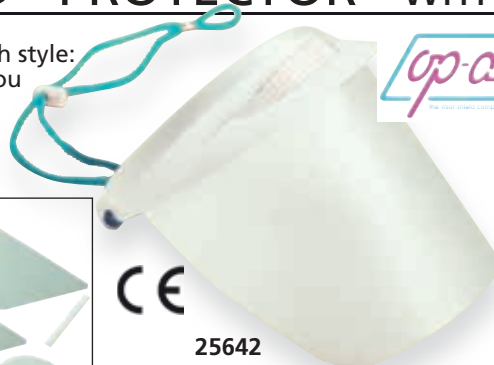

25642

Multilingual box: GB, FR, IT, ES, PT, DE, NL, DK, GR.



## VISOR HEAD MASKS

### VISOR HEAD MASKS

#### Great features

- faceshield with 90° rotation
- inner and outer surface treated against mist
- superior coverage to protect against droplets and splashes

#### Superior materials

- elastic band in anallergic material
- rotation systems in plastic material
- soft support in anallergic interchangeable foam
- faceshield in heat-formed acetate with anti-fog treatment

#### Easy and comfortable use

- fitting headbands adjustable by velcro fasteners
- usable over ophthalmic glasses

GIMA code	VISOR HEAD	Minimum order
25656	VISOR HEAD MASK	1
25668	VISOR SHIELD	1
25669	SPARE SHIELD for 25668	box of 5

Antifog mask  
0.5 mm thick

CE Class II EN 166-167-168 U1SN

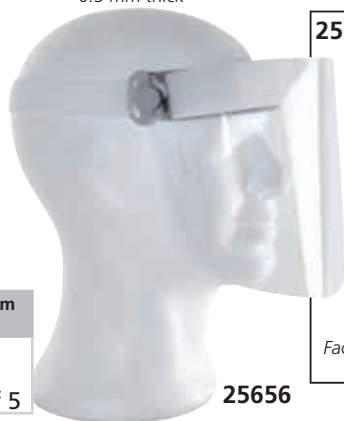

25656



25668

25656  
Faceshield with 90°  
max rotation



Antifog  
mask  
0.5 mm  
thick  
25668

## GIMA PROTECTIVE SHIELDS

### • 30846 GIMA PROTECTIVE SHIELD - fixed shield

### • 30843 GIMA PROTECTIVE SHIELD - liftable shield

Protective visor made of polycarbonate with large transparent surface and high coverage degree, it allows to maintain eye contact by protecting eyes and mucous membranes in complete safety.

Sanitizable, universal size and extremely ergonomic thanks to its simil velcro closure band and soft, interchangeable pad.

MADE IN ITALY

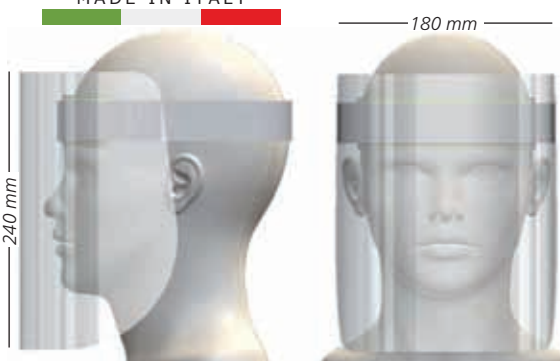

240 mm

180 mm



30843 Weight 125 g  
30846

30843  
30846

30843  
Liftable shield

Suitable for clinical/professional and for personal use.

It is usable with glasses, wide peripheral vision.

Gima protective shield is compliant with International Standards (PPE, UE 2016/425, Class II, EN 166:2001).

Supplied in a polyethylene bag with multilingual instructions:

GB, FR, IT, ES, PT, DE, GR, RO, PL, SE, HU, CZ.

### • 30847 FOREHEAD PADDING

for 30843, 30846 - spare



Interchangeable  
forehead padding

30846

## DISPOSABLE ANTI-FOG FACE SHIELD

### • 25662 DISPOSABLE ANTI-FOG FACE SHIELD

Protective disposable face shield made of anti-fog hydrophilic film.

Clear and smooth visor allows to maintain eye contact by protecting whole face against potential contamination from blood pathogens, fluids or harmful chemical splash.

It is equipped with sponge strip and elastic band.

Size: 330x220 mm.

Multilingual instructions: GB, FR, IT, ES, PT, DE, GR, RO, PL.

17



Sponge strip:  
270x35x35 mm  
Elastic band:  
12 mm



25662



# PROTECTIVE GOGGLES



• **25661 POLYSAFE MEDICAL - bulk**  
 • **25660 POLYSAFE MEDICAL - with box**  
 They are a vital part of any infectious disease control programme for eye protection. They provide a wide field of vision and excellent optical quality. Designed with top and side shields to protect eyes from every angle. They can fit all head sizes comfortably, and have superior optical clarity. Autoclavable. Norms EN 166:2001. Multilingual instructions: GB, FR, IT, ES, PT, DE, NL, SE, PL, HU, RO, BG, GR, Arabic



• **25659 GIMASAFE - box of 10 pcs**  
 Transparent protective goggle. Norms: EN 166.  
 Goggles are individually packed and can be sold individually.



• **25263 OP-TEMA GOGGLES - black - anti-scratch**  
 Lightweight full view polycarbonate lenses, resistant to abrasions.  
 Built-in moulded brow bar.  
 Adjustable nosepiece, temple length and lens angle.  
 100% UV Filtration  
 Norms: EN 166, EN 170.



• **25667 PROTECTIVE GOGGLES 5X7 - fog resistant and anti-scratch**  
 Superior quality goggles with excellent optical quality, high protection and maximum comfort. Optical quality: Class I.  
**Protection:** protection against high speed particles-low energy and lateral protection. Protection against optical radiations to standard EN 170. Antifog and anti-scratch.  
**Comfort:** ultra light, soft pad technology temples, adjustable in length. Norms: EN 166.



• **25644 SAN DIEGO GOGGLES - black - fog resistant and anti-scratch**  
 • **25645 SAN DIEGO GOGGLES - blue - anti-scratch**  
 Temple length and inclination adjustment by snap motion.  
 Protection against high speed particles - low energy and lateral protection. Protection against optical radiation to standard EN 170.



• **25260 505 UP GOGGLES - fog resistant, anti-scratch**  
 Protection against high speed particles - low energy and lateral protection. Protection against optical radiation to standard EN 170.  
 - extremely light 24 g only and encircling  
 - elastic structure, extremely flexible and resistant  
 - optimal comfort and fit thanks to the soft adjustable nosepad  
 - neck cord included in the packaging



• **25261 506 UP GOGGLES - green - fog resistant, anti-scratch**  
 • **25262 506 UP GOGGLES - pink - fog resistant, anti-scratch**  
 Same as 25260 without neck cord, with below additional features:  
 - panoramic wrapping lens  
 - temple regulation in length and inclination  
 - soft terminal tips to eliminate local pressure

## GOGGLES KIT

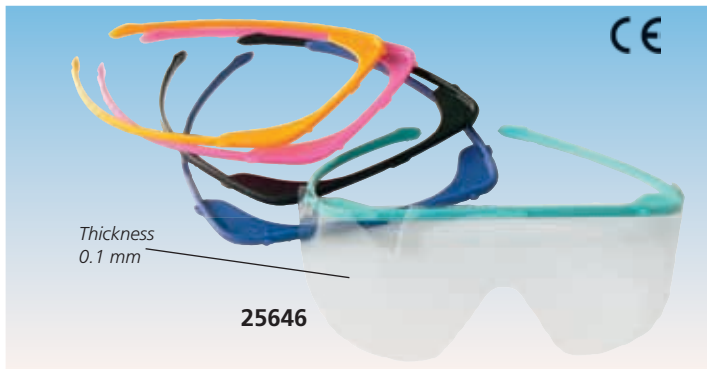

- **25646 GOGGLES KIT - fog resistant**  
Practical kit composed of 5 supports in different colours and 20 antifog shields.  
Usable over ophthalmic glasses.  
Norms: EN 166, EN 167, EN 168.
- **25647 SPARE SHIELDS - box of 20**

## AVATAR GOGGLES

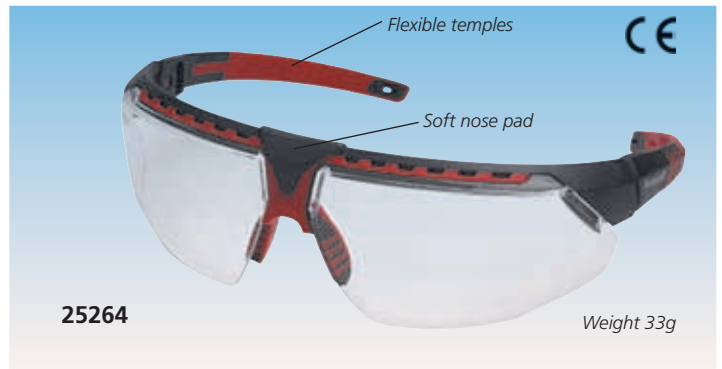

- **25264 AVATAR GOGGLES - black/red - fog resistant, antiscratch**  
Anti-fog coating goggles provide anti-scratch performances to keep lenses clear and workers safe. Ultra-light and soft brow frame. 9 base lenses made of polycarbonate with hydroshield coating. Provided with innovative and adjustable nose pad. PPE Category II. Norms: EN 166, EN 170.

## HIGH PROTECTION GOGGLES AND MASK



- **25663 HIGH PROTECTION GOGGLES - fog resistant and anti-scratch**  
Protection against: droplets and splashes of liquids and high-speed particles at extreme temperature. Lateral protection. Protection against large dust particles (>0.5 µm). Protection against optical radiation to standard EN 170. Resistance to surface damage by fine particles. Resistance to fogging of oculars. Norms: EN 166, EN 170.



- **25265 HIGH PROTECTION MASK 6x1 - fog resistant, anti-scratch**  
- wide lens for a field of view without distortion  
- temples adjustable in length and inclination with SoftPad technology  
- sophisticated indirect ventilation system  
- soft internal rubber for comfort without local pressure  
- certified according to EN166 point 3 (droplets and splashes) and point 4 (large dust particles)  
- supplied with elastic band

## MASK-OP® 99% FILTERING MASKS WITH VISOR - TYPE IIR

### MASK-OP® WITH VISOR

- **25652 MASK-OP® - ear loops - green - box of 50**
  - **25654 MASK-OP® - lacets - light blue - box of 50**
- ### MASK-OP® WITH WRAPPING VISOR
- **25636 MASK-OP® - ear loops - green - box of 50**
  - **25637 MASK-OP® - lacets - light blue - box of 50**
- Liquid splash resistant and anti-fogging surgical mask with antistatic visor.
- 4 layers: three made of non-allergenic woven non-woven and one of polyethylene net
  - nuisance-free and adaptable nose-clip
  - filtering efficiency (B.F.E.) ≥99%, according to EN 14683:2019+AC:2019
  - resistance to breath <30,0 Pa/cm<sup>2</sup>, according to EN 14683:2019+AC:2019
  - latex-free
  - non sterile
  - liquid splash resistance: resistant at pressure of 16 kPa, according to ISO 22609, related to EN 14683:2019+AC:2019
  - anti-fogging internal stripe made of expanded polyethylene
  - Bioburden ≤ 30 CFU/g, according to EN 14683:2019+AC:2019

Medical Device Class I Regulation EU 2017/745.

Multilingual box: GB, FR, IT, ES, PT, DE, GR, PL, RU, Arabic.

MASK-OP® WITH VISOR



B.F.E. ≥99%

CE

MASK-OP® WITH WRAPPING VISOR



MADE IN ITALY

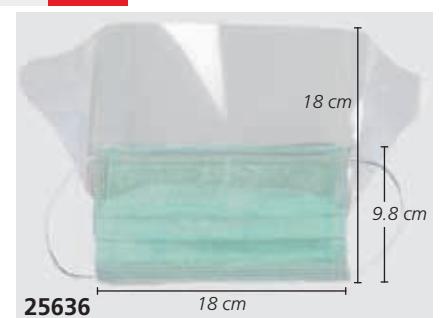



# MYCROCLEAN HIGH PROTECTION MASKS - BFE 99.8%

Reusable surgical protective masks classified Type II according to the UNI EN 14683:2019 standard. Made of polyester 99% and carbon fiber fabric 1%.

Materials are of EEC preferential origin. Patented design.

**Washable**

Washable, by hand or in the washing machine at 60°C/140°F.

MADE IN ITALY



20751-20756

**2 LAYERS  
WATER  
REPELLENT**

20750-20755



20760

**WASHABLE  
500 TIMES**

20764



20775

**WASHABLE  
500 TIMES**

20776



**PFE & BFE values**

Particle Filtration (%) 0.3 µm: 90% - 0.5 µm: 95%.

Certified non-cytotoxic by tests carried out according to UNI EN ISO 10993-5. BFE = 99.8% (from laboratory tests carried out in accordance with UNI EN 14683:2019).

**Biological load**

UFC < 30 UFC (from laboratory tests carried out in accordance with UNI EN 14683:2019). Air permeability (cm<sup>2</sup>/cm<sup>3</sup>/sec) ASTM E96 (also known as ISO-11092 or Ret or Hohenstein test) = 7,5.

**2020V3TN MASKS for health professional and medical use**

Double layer with water repellent outer layer washable up to 100 times at 60°C/140°F.

GIMA code	HEALTH PROFESSIONAL - MEDICAL USE MASKS			
	Size	Colour	Hem	Nose clip
20750	Adult	white	white	yes
20751	Adult	white	blue	yes
20755	Adult	white	white	no
20756	Adult	white	blue	no

**2020V3 MASKS for health professional and outdoor/indoor use**

One layer. Washable up to 500 times at 60°C/140°F.

Possibility to customize with 1 colour logo (minimum 1.000 pcs)

GIMA code	HEALTH PROFESSIONAL - INDOOR/OUTDOOR USE MASKS			
	Size	Colour	Hem	Nose clip
20760	Adult	white	white	yes
20764	Adult	blue	white	no
20765	Adult	white	blue	no
20766	Adult	white	red	no
20767	Adult	blue	blue	no
20770	Junior/Adult small	white	blue	no
20771	Junior/Adult small	blue	blue	no
20772	Junior/Adult small	white	red	no
20775	Kid (age 6-9)	white	red	no
20776	Kid (age 6-9)	blue	blue	no



All masks have multilingual instructions: GB, FR, IT, ES, PT, DE, GR, SE, PL, RO, Arabic.

# SAFE COMFORT 5-LAYER REUSABLE PROFESSIONAL MASK TYPE IIR

**• 20730 SAFE COMFORT 5-LAYER REUSABLE MASK TYPE IIR**

The Safe Comfort mask consists of five layers of non-woven polypropylene sandwich laminates. Each layer has a specific function: anti-splash, protective, filtering, dissipating, hypoallergenic. Latex-free and phthalates free. Biocompatibility and biological safety of materials.

- professional bacterial protection face mask made in Italy
- five-layer hypoallergenic material made in Germany
- maximum biological filtration at surgical level in accordance with CE ISO 14683 Medical Device (type IIR)
- effective barrier against viruses, bacteria and spores in air dispersion and aerosols
- excellent nose-mouth breathability with spongy intermediate layer for dissipation of heat exhaled
- autoclavable, BFE tested up to 20 cycles
- reusable and machine washable (40°C - 35')
- one minute disinfection with a domestic microwave oven
- the innovative Safe Comfort design adheres perfectly and does not cause irritation and blisters
- elastic with easily adjustable self-adaptive sliding system



MADE IN ITALY

- absence of valve to avoid transmission of the virus
  - the special shape of the nose piece allows you to position the protective glasses over the mask to prevent lens fogging.
- Multilingual box and instructions: GB, FR, IT, ES, PT, DE, GR, PL, SE, CZ.

**DUAL CERTIFICATION:  
FACE MASK AGAINST COVID-19 PPE-RFU/02.075  
SURGICAL MASK M.D. EN 14683 TYPE IIR**



20730



**B.F.E. >99%**

**TECHNICAL SPECIFICATIONS**

Material:	Non woven fabric, polypropylene, 5-layers with different density/thickness/texture	Reusable No.:	X times (upon care when used)
Bacterial Filtration Efficiency:	Test BFE 99,9% exceed ISO Standard Annex B (BFE≥98%)	Machine washable:	40°C-35' (Test BFE 99,9% after 5 wash)
Differential Pressure / Breathability:	Test 53,9 Pa/cm <sup>2</sup> exceed <60 Pa/cm <sup>2</sup> / Type IIR Annex C	Disinfectable:	With alcohol spray (isopropanol) No. X times In microwave oven max 1' - 700W No. X times In thermo-pouch at 121°C-28' (Test BFE 99,9% after 20 cycles)
Microbic Cleanless:	Test 12 cfu/g Bioburden exceed ISO EN 11737-1:2018 Annex D - <30 ufc/g	Autoclavable:	UNI EN 14683:2019 Type IIR; ISO EN ISO 10993-1-5-10-12-18; ISO EN 11737-1:2018; ISO 22609:2005 EN 149:2001+A1:2009
Blood Splash Resistant:	≥ 16,0 (kPa) Type II R, EN 14683 Annex C	Conform to normative:	

# GISAFE 98% FILTERING 3 PLY SURGICAL MASKS TYPE IIR WITH LOOPS

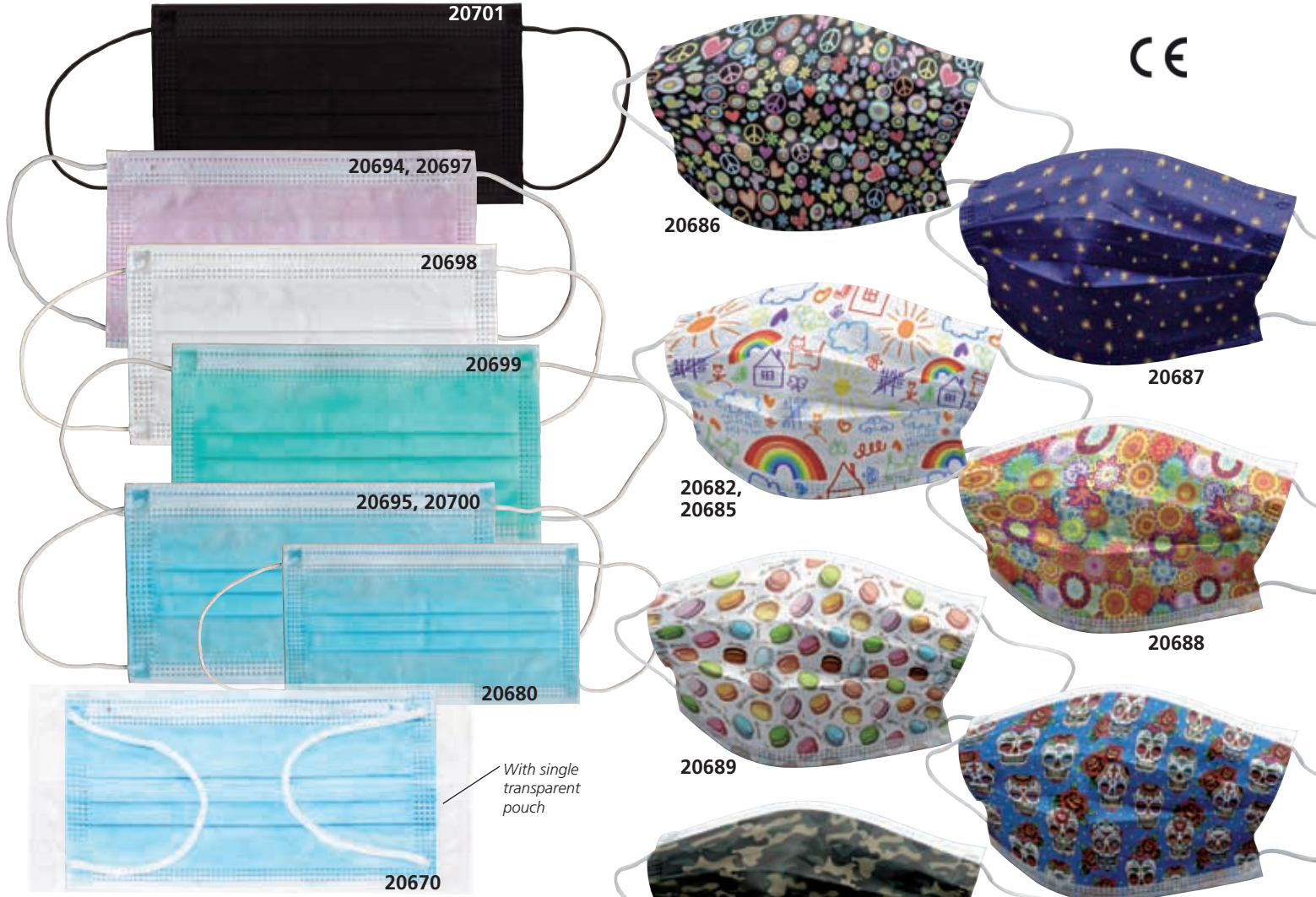

**98% FILTERING 3 PLY MASKS - TYPE IIR with ear loops**  
 Lightweight and comfortable surgical masks suitable for hospital, dental and outpatient use.

- large range: adult mask in 5 colours, 7 patterns;
- pediatric mask in 1 colour or 1 pattern
- available in box of 50 or flowpack of 10 pcs
- conformable nose band for anatomical fitting
- fiber glass free, filtration efficiency BFE ≥98%
- non woven material, latex free
- 1st ply, outside 28 gsm non woven
- 2nd ply, 25 gsm melt blown filter
- 3rd ply, inside 25 gsm non woven



Multilingual box: GB, FR, IT, ES, PT, DE, GR, SE, RO, Arabic



Multilingual flowpack: GB, FR, IT, ES, PT, DE, GR, Arabic.

TECHNICAL SPECIFICATIONS	
BFE%	≥ 98
Differential pressure (Pa/cm <sup>2</sup> )	< 60
CfU/g	< 30
Size cm:	17.5x9.5 (adult) - 14x9 (pediatric)
EN 14683:2019 + AC:2019 conform; MDR 2017/745 Class I	

GIMA code	GISAFE 3 PLY SURGICAL MASK - ear loops		
	ADULT MASKS - box	Colour / Pattern	Minimum order
20697	3-ply masks - coloured	pink	box of 50
20698	3-ply masks - coloured	white	box of 50
20699	3-ply masks - coloured	light green	box of 50
20700	3-ply masks - coloured	light blue	box of 50
20701	3-ply masks - coloured	black	box of 50
ADULT MASKS in single transparent pouch - box			
20670	3-ply masks - coloured	light blue	box of 50
ADULT MASKS - flowpack			
20694	3-ply masks - coloured	pink	flowpack of 10
20695	3-ply masks - coloured	light blue	flowpack of 10
20696	3-ply masks - coloured	light blue	box of 2000*
20685	3-ply masks - patterned	cartoon	flowpack of 10
20686	3-ply masks - patterned	peace	flowpack of 10
20687	3-ply masks - patterned	stars	flowpack of 10
20688	3-ply masks - patterned	colours	flowpack of 10
20689	3-ply masks - patterned	macarones	flowpack of 10
20690	3-ply masks - patterned	skulls	flowpack of 10
20691	3-ply masks - patterned	military	flowpack of 10
PEDIATRIC MASKS - flowpack			
20680	3-ply masks - coloured	light blue	flowpack of 10
20682	3-ply masks - patterned	cartoon	flowpack of 10

\*200 flowpacks of 10 pieces

## PREMIUM 98% FILTERING 3 PLY MASKS TYPE II

### PREMIUM 98% FILTERING 3 PLY MASKS - TYPE II WITH EARLOOPS

Lightweight, soft and comfortable 3 ply surgical masks with adjustable noseclip. 100% high quality Italian materials and manufacturing. Latex free.

Made up of 3 extremely soft layers for utmost comfort:

- outer layer: soft 25g non-woven fabric, for protection from dust and residues
- middle layer: 25g meltblown antiparticulate and antibacterial filter with high filtering power
- inner layer: 25g non-woven fabric for effective absorption of sweat and moisture.

Each box contains 5 pouches of 10 masks. Each pouch has instructions in GB, IT and can be individually sold.

PREMIUM 3 PLY SURGICAL MASKS - ear loops			
GIMA code	ADULT MASKS	Colour	Minimum order
20600	3-ply masks	light blue	box of 50
20601	3-ply masks	dark blue	box of 50
20602	3-ply masks	black	box of 50
20603	3-ply masks	pink	box of 50
20604	3-ply masks	red	box of 50
20610	3-ply masks	other colours*	50 boxes of 50

\* Available in white, dark beige, brown, grey, yellow, emerald green, green, pearl, wisteria, bordeaux, olive green, light beige, denim, fuchsia, orange, turquoise

TECHNICAL SPECIFICATIONS		
BFE%:	> 98%	Size: 17.5x9.5 cm
Differential pressure (Pa/cm <sup>2</sup> ):	< 40	Norms: EN 14683:2019

B.F.E. ≥98%

MADE IN ITALY

Multilingual instructions and box: GB, FR, IT, ES, PT, DE, PL, GR, RO, FI, SI, SK, DK, EE, NO, SE, NL, HU, HR, BG, CZ, LV, LT, RU, RS, Arabic.

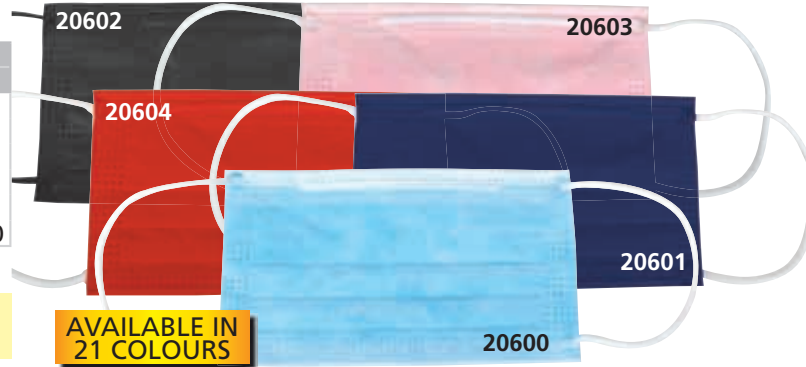

AVAILABLE IN 21 COLOURS

## AFLUID® LIQUID SPLASH RESISTANT 4-PLY SURGICAL MASKS TYPE IIR

- 20702 AFLUID® 4-PLY SURGICAL MASK with ear loops - light blue - box of 900 (18 boxes of 50)
- 20703 AFLUID® 4-PLY SURGICAL MASK with lacets - green - box of 600 (12 boxes of 50)
- 20704 AFLUID® 4-PLY SURGICAL MASK with lacets - light blue - box of 600 (12 boxes of 50)

Liquid splash resistant surgical masks made of one layer of polyethylene net and three layers of non-woven, disposed to form a "sandwich". Each layer is structured differently according to the specific function, made for: liquid splash resistant, protective, filtering, non-macerating.

AFLUID® intensifies its own features in case of high contamination risk: an additional layer made of a film of hexagonal structure polyethylene net allows resistance to splashes of potentially contaminated liquids, which are a possible transmission carrier of infective viruses.

Type IIR surgical mask, according to EN 14683:2019 + AC: 2019. Class I medical device, self-certificated at the Italian Ministry of Health. Suitable for surgeons and operating room staff to ensure protection from potential infected patients.

MADE IN ITALY



20703

B.F.E. ≥99%

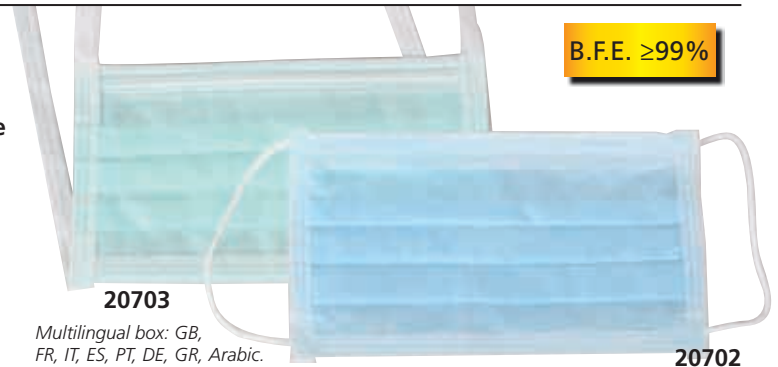

Multilingual box: GB, FR, IT, ES, PT, DE, GR, Arabic.

TECHNICAL SPECIFICATIONS	
4 layers:	1 <sup>st</sup> liquid splash resistant layer - hexagonal structure polyethylene net
	2 <sup>nd</sup> coloured outer layer - cellulose and polyester, with oriented fibres
	3 <sup>rd</sup> filtering layer - melt blown polypropylene fibrils
	4 <sup>th</sup> anti-macerating inner layer - polypropylene - polyethylene (in contact with the face)
Edges:	Non allergic white polypropylene
Sizes - weight:	98x180 ± 3 mm - 3.5g (20702)
	92x180 ± 3 mm - 4.2g (20703, 20704)
Filtering efficiency (B.F.E.):	≥99% according to EN 14683:2019 + AC:2019
Resistance to breath:	<30 Pa/cm <sup>2</sup> according to EN 14683:2019 + AC:2019
Bioburden:	≤30 CFU/g according to EN 14683:2019 + AC:2019
Liquid splash resistance:	16 kPa pressure resistant, according to ISO 22609, related to EN 14683:2019 + AC:2019

## MASKELLA® AND MASKERITA® 98% FILTERING MASKS - EN 14683:2019

- 25648 MASKELLA® - face mask with ear loops - light blue - box of 900 (18 packs of 50)
  - 25649 MASKERITA® - surgical face mask with lacets - light green - box of 600 (12 packs of 50)
  - 3 non-allergenic woven-non woven layers
  - size 98x180 mm (25648), 92x180 mm (25649)
  - weight 2.8 g (25648), 3.3 g (25649)
  - tensile strength extra-long ties or lacets
  - comfortable, shapeable nose clip
  - filtering efficiency B.F.E. ≥98%
  - resistance to breath < 28 Pa/cm<sup>2</sup>
  - Bioburden ≤ 30 CFU/g
  - B.F.E., Bioburden, resistance to breath according to EN 14683:2019+AC:2019, Regulation (EU) 2017/745
  - non sterile, latex free
- Multilingual box: GB, FR, IT, ES, PT, DE, GR, Arabic.

MADE IN ITALY

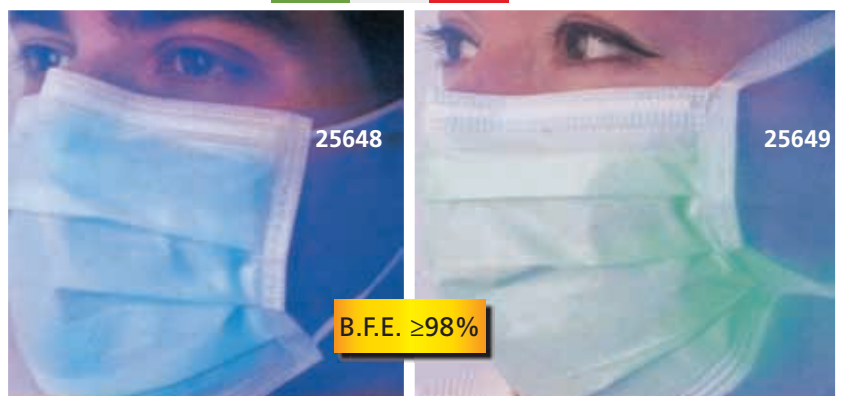

B.F.E. ≥98%

# VALUE&SAFE FFP2 FILTERING MASKS

## VALUE&SAFE FFP2 FILTERING MASKS WITH EAR LOOPS

Five-layer FFP2 mask to protect yourself and others effectively. Meeting FFP2 requirements of EN 149:2001+A1:2009 in accordance with the PPE regulation EU 2016/425.

- ergonomic design fit face closely
- non irritating, soft and skin-friendly inside non woven fabric
- adjustable nasal clip
- stretchable ear loops, painless after long-time wearing
- foldable in half for easy gathering
- each mask is individually packed in a transparent pouch
- latex free (adult only)

**FFP2 FILTERING EFFICIENCY >94%**



CE 0370

20732, 20733

### FILTERED PARTICLES

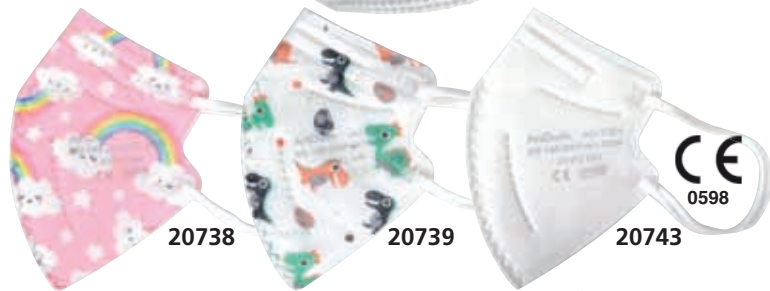
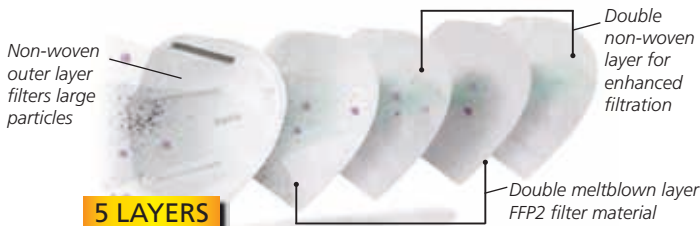
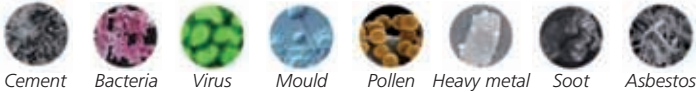

20738

20739

20743

CE 0598



20731

20734

20736

20735

CE 0370

VALUE&SAFE FFP2 FILTERING MASKS				
GIMA code	Model	Box and instructions languages	Pattern or colour	Minimum order
<b>FFP2 WITHOUT VALVE</b>				
20738	FFP2 - adult-small	GB, FR, IT, ES, DE	rainbow	box of 20
20739	FFP2 - adult-small	GB, FR, IT, ES, DE	dinosaurs	box of 20
20743	FFP2 - adult-small	GB, FR, IT, ES, DE	white	box of 20
<b>FFP2 WITHOUT VALVE</b>				
20731	FFP2 - adult	GB, FR, IT, ES, DE	light grey	box of 20
20732	FFP2 - adult	GB, FR, ES, DE, PT	white	box of 20
20733	FFP2 - adult	IT, GR, PL, CZ, RO	white	box of 20
20734	FFP2 - adult	IT, GR, DE, SE, PL	blue	box of 20
20735	FFP2 - adult	GB, FR, IT, ES, PT	black	box of 20
20736	FFP2 - adult	GB, IT, PT, RO, CZ	burgundy	box of 20
<b>FFP2 WITH VALVE</b>				
20737	FFP2 - adult	GB, FR, IT, ES, PT	white	box of 20
<b>TECHNICAL SPECIFICATIONS</b>				
Inhalation:	30 l/min% ≤ 0.7	Size:	Adult-small	Adult
Inhalation:	95 l/min% ≤ 2.4	unfolded:	18x13.5 cm	21x15.5 cm
Exhalation:	160 l/min% ≤ 3.0	folded:	9x13.5 cm	10.5x15.5 cm
Penetration of filter material:	≤ 6%			



FFP2 with valve

20737

Each mask is individually packed

# EFFECTIVE FFP2 PARTICLE FILTERING MASKS

• 20740 EFFECTIVE FFP2 FILTERING MASK GB, FR, ES, PT, DE - box of 20 (4 bags of 5)

• 20741 EFFECTIVE FFP2 FILTERING MASK IT, SE, GR, RO, ARABIC - box of 20 (4 bags of 5)

Six-layers filtering FFP2 mask to protect yourself and others effectively.

Meeting FFP2 requirements of EN 149:2001+A1:2009 in accordance with the PPE regulation EU 2016/425.

- ergonomic design fit face closely
- non irritating, and soft inside non woven fabric
- adjustable nasal clip
- flexible and stretchable ear loop, painless after long-time wearing
- foldable in half for easy gathering

Includes 20 hooks for elastic adjustment behind head.

**6 LAYERS**

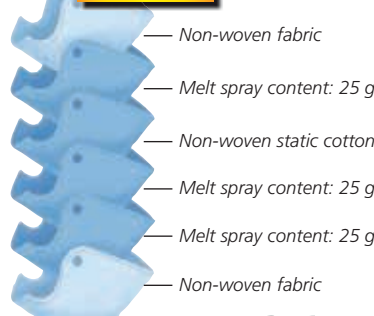

**FFP2 >94%\***

\*Filtering efficiency



CE 0598

FDA

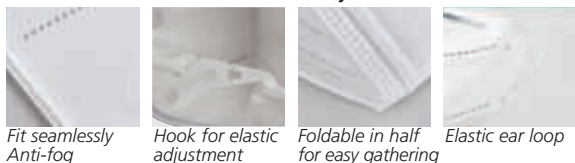

Fit seamlessly Anti-fog

Hook for elastic adjustment

Foldable in half for easy gathering

Elastic ear loop



20740

TECHNICAL SPECIFICATIONS	
Inhalation:	30 l/min% ≤ 0.7
Inhalation:	95 l/min% ≤ 2.4
Exhalation:	160 l/min% ≤ 3.0
Penetration of filter material:	≤ 6%
Size unfolded:	21.4x16 cm
folded:	10.7x16 cm

# COMFYMASK FFP2 FILTERING MASKS - WITH EARLOOPS

## CEPM EUROPEAN CONSORTIUM OF MASK PRODUCERS

CEPM is a constantly evolving consortium of more than 25 leading Italian and European companies committed to producing CE marked masks, with technologies and facilities located throughout Europe. They guarantee production of hundreds of millions of FFP2 and surgical masks per year. CEPM is the response to the market need linked to the health emergency caused by COVID-19, ensuring a continuous and constant control of standards imposed by the Health Authority with regard to:

- product analysis with accredited laboratories;
- certified production system guaranteed with CE mark;
- CEPM Scientific Technical Committee.

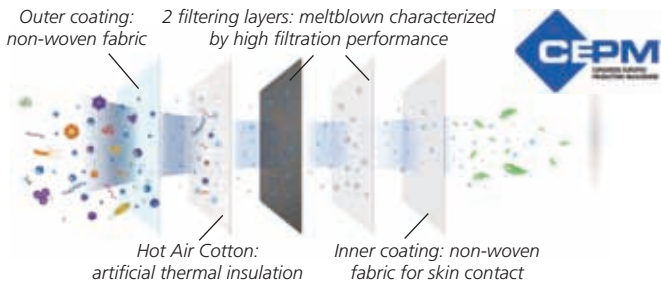

## COMFYMASK AND COMFYMASK FIT with earloops

GIMA offers 2 lines of FFP2 masks entirely made of high quality Italian materials.

**Comfymask** ensure optimal comfort throughout the day thanks to the soft material. Its design allows greater facial movement and adaptability to the face, without tighten nose and ears.

**Comfymask Fit** is a stylish line with ergonomic design, that allows excellent fit, adapting perfectly to face shape.

Both lines are available in a wide range of trendy colours. FFP2 filtering mask provides an adequate protection of the respiratory tract against particulates (dust, fumes, mists and microorganisms), non-toxic liquid and solid aerosols.

Filter efficiency is >94%, according to EN149.

### Five layers:

- outer coating: non-woven fabric
- Hot Air Cotton: artificial thermal insulation
- 2 meltblown layers: provide high filtration performance
- inner coating: non-woven fabric suitable for skin contact, according to ISO10993

Provided with elastic stretch fabric and adjustable nose clip made of steel.

### Individually packed in transparent pouch:

All masks are individually packed with 4 language instructions (GB, FR, IT, ES) printed on envelope.



20630



FFP2 NR  
>94%\*

\*Filtering efficiency



20641

MADE IN ITALY



20621 20623 20627 20625 20626 20622 20620 20624  
20631 20633 20637 20635 20636 20632 20630 20634  
20650



20641 20647 20643 20640 20642 20644 20646 20645  
20662

GIMA code	COMFYMASK	Minimum order
Standard Large	COMFYMASK in box of 20*	
20620	20630 FFP2 - white	box of 20
20621	20631 FFP2 - black	box of 20
20622	20632 FFP2 - dark blue	box of 20
20623	20633 FFP2 - pink	box of 20
20624	20634 FFP2 - blue	box of 20
20625	20635 FFP2 - dark green	box of 20
20626	20636 FFP2 - red	box of 20
20627	20637 FFP2 - light grey	box of 20
Standard	COMFYMASK in box of 100*	
20650	FFP2 - white - GB, FR, IT, ES	box of 100
20652	FFP2 - white - IT	box of 100
20659	FFP2 - white any language**	100 boxes***



GIMA code	COMFYMASK - FIT	Minimum order
Standard Large	COMFYMASK - FIT in box of 20*	
20640	FFP2 - white	box of 20
20641	FFP2 - black	box of 20
20642	FFP2 - dark blue	box of 20
20643	FFP2 - pink	box of 20
20644	FFP2 - light blue	box of 20
20645	FFP2 - lilac	box of 20
20646	FFP2 - burgundy	box of 20
20647	FFP2 - grey	box of 20
Standard Large	COMFYMASK - FIT in box of 100*	
20662	FFP2 - white - GB, FR, IT, ES	box of 100
20669	FFP2 - white any language**	100 boxes***



\*Multilingual box (only box of 20) or neutral box (box of 100) include 1 multilingual instruction (GB, FR, IT, ES, PT, DE, PL, GR, RO, FI, SI, SK, DK, EE, NO, SE, NL, HU, HR, BG, CZ, LV, LT, RU, RS, Arabic).

\*\*Envelope can be printed in any language. Availability in 20-30 days.  
\*\*\* Minimum order: 100 boxes of 100.

## GIMA HALO FFP2 AND FFP3 HEALTH CARE PARTICULATE RESPIRATORS

### GIMA HALO RESPIRATORS

- 20780 FFP2 WITHOUT VALVE - ear loops - box of 25
  - 20785 FFP3 WITHOUT VALVE - ear loops - box of 25
  - 20786 FFP3 WITH VALVE - headband - box of 15
- Fish-type, 5 layers FFP2 and FFP3 respirators with or without valve, provide effective respiratory protection.

#### Features:

- foldable, 3-panel design allows greater facial movement and wearer comfort
- integrated nose clip helps conform to the nose and contours of the face
- comfortable ear loops and headband

EN 149:2001+A1:2009 (Respiratory protective devices - Filtering half masks to protect against particles) PPE regulation 2016/425. Individually packed in pouch.

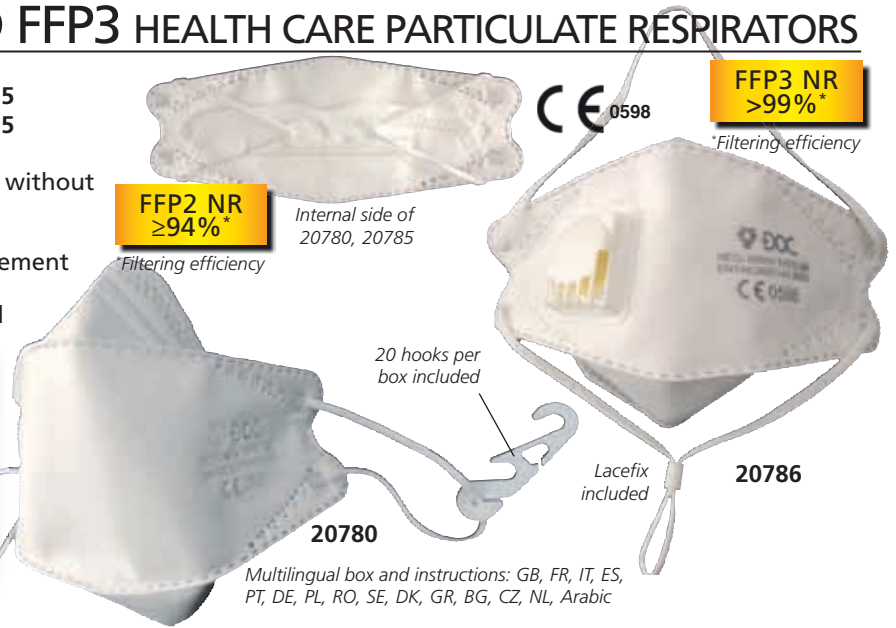

## 3M™ AURA™ FFP2 1862+ AND FFP3 1863+ HEALTH CARE PARTICULATE RESPIRATORS IIR

- 20715 3M™ AURA™ FFP2 RESPIRATOR 1862+ IIR - box of 20
  - 20716 3M™ AURA™ FFP3 RESPIRATOR 1863+ IIR - box of 20
- The 3M™ Aura™ Particulate Respirators provide effective respiratory protection for use in medical environments where health care workers are exposed to airborne dust particles, non-volatile liquid particles and bio-aerosols.

Limiting the transmission of infective agents from staff to patients and suitable for use during surgical procedures and certain other medical procedures. Resistance to penetration of liquid splashes.

#### Key Features

- tested to EN 14683:2019 (Surgical masks - Requirements and test methods) and EN 149:2001+A1:2009 (Respiratory protective devices - Filtering half masks to protect against particles - Requirements, testing, marking)
- CE mark according to PPE Regulation 2016/425 and in compliance to EN 14683:2019 Type IIR as surgical mask according to Medical Device Directive 93/42/CEE
- foldable, proprietary 3-panel design allows for greater facial movement and wearer comfort and easy storage when not in use
- low breathing resistance filter technology gives effective filtration with low breathing resistance for consistent high quality performance
- sculpted nose panel helps conform to the nose and contours of the face and helps to improve compatibility with 3M eyewear



- innovative chin tab for easy positioning and adjustment
  - individual hygienic packaging protects the respirator from contamination before use
  - large, soft nosefoam is comfortable on the skin
  - headbands accommodate the shape of your neck, face and head
  - outer cover provides resistance to fluid splashes
  - coloured headbands for easy identification: blue for FFP2 and red for FFP3
- Multilingual box: GB, FR, IT, ES, PT, DE, NL, SE, DK, NO, FI, IS, GR, PL, HU, CZ, SK, SI, EE, LV, LT, RO, RU, UA, BG, TR.

## FOLD-FLAT RESPIRATORS FFP2, FFP3

Facial filtering respirators to protect against solid (non-oil) and liquid (oil) volatile particles.

- With exhalation valve. Double elastic with buttonhole allows to hang the mask to the neck when it's not worn.
- Polypropylene coated steel adjustable nose piece welded with high resistance and internal Polyurethane (PU) foam nose pad.
- Single pack guarantees total hygiene and easy maintenance.
- The shape of the respirator reduces difficulties of respiration improving efficiency in the dialogue.
- Innovative design allows a perfect view.
- Wide adaptability to various face contours.
- Wide filtering area to allow proper ventilation.
- Light weight.
- Single use.

Conforms to EC standard - EN 149:2001+A1:2009.



TECHNICAL SPECIFICATIONS		
	25670	25671
Protection:	FFP2	FFP3
Minimum filter efficiency	94%	99%
Valve	yes	yes
Vertically foldable	yes	yes
<b>Materials:</b> Filter: Polypropylene Fabric, Valve: rigid plastic		
Valve Membrane: Synthetic Rubber, Nose Piece: Polypropylene coated steel adjustable, Nose Pad: Polyurethane (PU) Foam		

GIMA code	PARTICULATE FOLDABLE RESPIRATORS	Minimum order
25670	Particulate respirator - FFP2 - with valve	box of 10
25671	Particulate respirator - FFP3 - with valve	box of 10

## G-PRIME FFP3 FILTERING MASKS

### G-PRIME FFP3 NR FILTERING MASKS

FFP3 respirators provide effective respiratory protection for workers who are exposed to fine toxic dusts, fibres, fumes.  
 - foldable, proprietary C type design accommodates facial movement for wearer comfort  
 - non-woven fabric, hot-air cotton, meltblown non-woven fabric

- low breathing resistance filter technology gives effective filtration with low breathing resistance for consistent high quality performance

Meeting European Standard EN 149:2001 + A1:2009, filtering facepiece respirators for use against particles. In accordance with PPE directive (EU) 2016/425.

Classified by filtering efficiency and maximum total inward leakage performance (FFP3), also by usability and clogging resistance.

Each mask is individually packed in a self sealing, hygienic plastic bag.

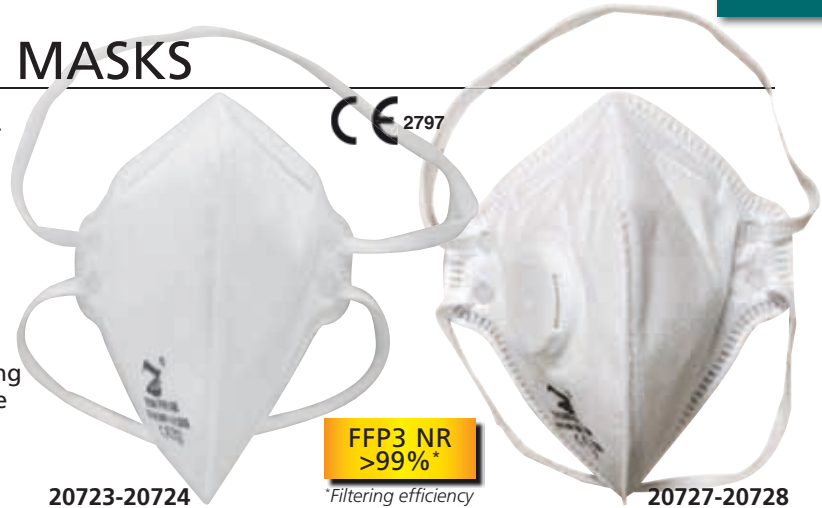

20723-20724

20727-20728

G-PRIME FFP3 FILTERING MASKS				
GIMA code	FFP3 WITHOUT VALVE	Languages	Elastic band	Minimum order
20723	FFP3 filtering mask	GB, FR, ES, DE, PT	white	box of 30
20724	FFP3 filtering mask	IT, GR, PL, SE, RO	white	box of 30
20725	FFP3 filtering mask	GB, FR, IT, ES, DE	blue	box of 30
FFP3 WITH VALVE				
20727	FFP3 filtering mask	GB, FR, ES, PT, DE	white	box of 20
20728	FFP3 filtering mask	IT, GB, PL, SE, RO	white	box of 20



20725

20727-20728

## DEFENCE CONICAL MASK FFP3

### • 20745 DEFENCE CONICAL FFP3 NRD MASK WITH VALVE - box of 10

Conical disposable filtering face mask, for protection against particles, dust and pollen.

Exhalation valve reduces the accumulation of humidity and heat.

Adjustable nose piece and elastic.

Protection > 99% (test report IFA 201920901/2120)

Tight sealed, comfortable use Norms: EN 149:2001 + A1:2009.

FFP3 with valve >99%\* Filtering efficiency

CE 0121



20745

Size: 15.5x13.5x7 cm

Multilingual box and instructions: GB, FR, IT, ES, PT, DE, SE, GR.



## CUP SHAPE MASKS FFP2, FFP3 WITHOUT VALVE

### • 20790 CONICAL FFP2 MASK WITHOUT VALVE - box of 20

### • 20792 CONICAL FFP3 MASK WITHOUT VALVE - box of 12

Conical disposable filtering face mask, standard (OES),

for protection against fine toxic dusts, fumes and mists.

Made of non-woven fabric,

Hot-Air cotton and meltblown non-woven fabric.

Meeting the FFP2 and FFP3 requirements of EN149:2001+A1:2009

Product Certification in accordance with the PPE directive (EU) 2016/425.

20790

FFP2 >94%\* Filtering efficiency

CE 2797



20790

20792

Multilingual box and instructions: GB, FR, IT, ES, PT, DE, PL, RO, SE, GR, CZ, NL, Arabic.



20792

FFP3 >99%\* Filtering efficiency

## NITRYLEX® BASIC - NITRILE GLOVES POWDER FREE

Non-sterile, powder free, examination and protective glove for single use. Optimal sensitivity to touch. PPE Class III

GIMA code	NITRILE GLOVES NON STERILE	Size	Colour	Minimum order
21801	Small	6-7	navy blue	box of 100
21802	Medium	7-8	navy blue	box of 100
21803	Large	8-9	navy blue	box of 100
21804	Extra large	9-10	navy blue	box of 100

Multilingual box and instructions: GB, FR, IT, ES, PT, DE, PL, GR, SE, NO, FI, DK, SK, CZ, BG, RO, HU, HR, RS, SL, KZ, LT, LV, RU, TR.



21802

## NITRYLEX® CLASSIC - NITRILE GLOVES POWDER FREE

Non-sterile, powder free, examination and protective glove for single use. Greater sensitivity to touch

GIMA code	NITRILE GLOVES NON STERILE	Size	Colour	Minimum order
21806	Small	6-7	blue	box of 100
21807	Medium	7-8	blue	box of 100
21808	Large	8-9	blue	box of 100
21809	Extra large	9-10	blue	box of 100

Multilingual box and instructions: GB, FR, IT, ES, PT, DE, PL, GR, SE, NO, FI, DK, SK, CZ, BG, RO, HU, HR, RS, SL, KZ, LT, LV, RU, TR.



21807

## SAFE PACK SYSTEM FOR NITRYLEX® CLASSIC ONE BY ONE

Innovative Safe Pack dispenser system made of plastic, for the distribution of gloves. It can be used only with Nitrylex® Classic One by One, powder free examination gloves (box of 200).

GIMA code	NITRILE GLOVES NON STERILE	Size	Colour	Minimum order
21811	Small	6-7	blue	box of 200
21812	Medium	7-8	blue	box of 200
21813	Large	8-9	blue	box of 200
21814	Extra large	9-10	blue	box of 200

21815 Safe Pack wall dispenser system - plastic

Multilingual box and instructions: GB, FR, IT, ES, PT, DE, PL, GR, SE, NO, FI, DK, SK, CZ, BG, RO, HU, HR, RS, SL, KZ, LT, LV, RU, TR.

**MINIMIZE RISK OF CROSS-CONTAMINATION**



There is no contact between the user's hand with the working surface of the glove or with the box.



21815

21812 + 21815

Special folding method allows extraction of a single glove from the cuff



## NITRYLEX® BLACK - NITRILE GLOVES POWDER FREE

Non-sterile, powder free, examination and protective glove for single use. Opaque finish.

GIMA code	NITRILE GLOVES NON STERILE	Size	Colour	Minimum order
21816	Small	6-7	black	box of 100
21817	Medium	7-8	black	box of 100
21818	Large	8-9	black	box of 100
21819	Extra large	9-10	black	box of 100

Multilingual box and instructions: GB, FR, IT, ES, PT, DE, PL, GR, SE, NO, FI, DK, SK, CZ, BG, RO, HU, HR, RS, SL, KZ, LT, LV, RU, TR.



21817

## NITRYLEX® AMBULANCE HIGH RISK - NITRILE GLOVES POWDER FREE

Non-sterile, powder free, examination and protective glove for single use. Thicker for extra safety in demanding work conditions.

GIMA code	NITRILE GLOVES NON STERILE	Size	Colour	Minimum order
21821	Small	6-7	orange	box of 100
21822	Medium	7-8	orange	box of 100
21823	Large	8-9	orange	box of 100
21824	Extra large	9-10	orange	box of 100

Multilingual box and instructions: GB, FR, IT, ES, PT, DE, PL, GR, SE, NO, FI, DK, SK, CZ, BG, RO, HU, HR, RS, SL, KZ, LT, LV, RU, TR.



Extended cuff for additional protection



21822

### TECHNICAL SPECIFICATIONS NITRYLEX®

	Basic	Classic	Classic One by One	Black	Orange
External surface:	fingertips textured		micro + fingertips textured, polymerized		
Powder content:			< 2mg/glove		
Cuff:			beaded		
AQL:	≤ 1.5	≤ 1.0	≤ 1.0	≤ 1.0	≤ 1.0
MD (Medical Device):			Class I		
PPE (Personal Protective Equipment):	Category I	Category III	Category III	Category III	Category III



## NITRILE GLOVES - POWDER FREE

Superior protection



### NITRILE GLOVES

Disposable nitrile examination gloves, powder free and latex free, extremely sensitive and resistant. The micro textured surface ensures an optimal grip. Suitable for use in hospital. Packed in dispenser of 100. Medical device Class I. PPE (Personal Protective Equipment) cat III. EN455-EN374-AQL<1.0

Standard regular blue 4.9 g*	Veloforte ice blue 3.5 g*	Zero** regular blue 3 g*	NITRILE GLOVES NON STERILE (box of 100)
25680	25679	25415	Small - non sterile
25681	25683	25416	Medium - non sterile
25682	25684	25417	Large - non sterile
-	-	25418	Extra large - non sterile

\*Weight for single glove - medium size \*\*Multilingual box GB, FR, IT, ES.

## NITRILE EXTRA LONG - 400 mm



- 25405 NITRILE GLOVES - extra long - medium - blue
- 25406 NITRILE GLOVES - extra long - large - blue

Disposable nitrile examination gloves powder-free and latex free. The micro textured surface assures a very good grip. Suitable for hospital use. The 400 mm length and resistance offer high level of protection. Packed in dispenser of 50. Non sterile. Medical device Class I. PPE cat III. EN455-EN374-AQL<1.5

## NITRILE LONG - 300 mm



Multilingual box: GB, FR, IT, ES, PT, DE.

- 25396 NITRILE GLOVES - small - regular blue - box of 100
- 25397 NITRILE GLOVES - medium - regular blue - box of 100
- 25398 NITRILE GLOVES - large - regular blue - box of 100

Disposable nitrile examination gloves powder-free and latex-free. The 300 mm length and 5.7 g weight ensure a high level of protection. The micro textured surface ensures a very good grip. Suitable for use in hospital. Medical device. Class I - EN455. PPE (Personal Protection Equipment) Cat III. Non sterile. EN420, EN374, EN388 AQL<1.5

## VINYL GLOVES - POWDER FREE



Elasticized for extra sensitivity and optimal grip.

25716

Powder free, ideal for sensitive skin



25692

### VINYL GLOVES

Gloves made of polyvinyl chloride, latex-free. Powder free, ideal for sensitive skins. For everyday use, they ensure protection and sensitivity. Suitable for dressing in hospitals and laboratory use. Packed in dispenser box of 100 units. MD class I. PPE cat II. EN455-EN374-AQL<1.5

Powder free elasticized	Powder free	VINYL GLOVES - NON STERILE (box of 100)
25716	25692	Small size - NON sterile
25717	25693	Medium size - NON sterile
25718	25694	Large size - NON sterile
-	25635	Extra large size - NON sterile

# LATEX GLOVES

- PRE POWDERED OR POWDER FREE



Pre-powdered **25706**

**25711** Powder free, ideal for sensitive skin

**LATEX GLOVES - ambidextrous - with hem**  
 Pure latex gloves non sterile.  
 Sensitive and resistant, ensure optimal grip and protection.  
 Suitable for dressing in hospital, ambulatory and laboratory.  
 Packed in dispenser of 100. Medical device Class I (all gloves).  
 PPE cat II (only powder free gloves).  
**EN455-EN374-AQL<1.5**

Pre powdered	Powder free	LATEX GLOVES NON STERILE (box of 100)
-	<b>25409</b>	Extra small size - non sterile
<b>25706</b>	<b>25711</b>	Small size - non sterile
<b>25707</b>	<b>25712</b>	Medium size - non sterile
<b>25708</b>	<b>25713</b>	Large size - non sterile
<b>25408</b>	<b>25410</b>	Extra large size - non sterile

# LATEX SURGICAL GLOVES - STERILE

# COPOLYMER GLOVES



Pre-powdered

**25685**

Powder free

**25695**

Super grip

**25709**

**25714**

**LATEX STERILE SURGICAL GLOVES**  
 The micro textured surface assures a very good grip in any use. High protection and anatomic shape assure a very good comfort. Sterilized by ETO.  
 Length 300 mm. Conform to USP: international pharmacopoeia.  
 Packed in pairs, dispenser of 50 pairs.  
 MD Class II A. PPE cat II.  
**EN455-EN 374-AQL<1.5**

Pre powdered	Powder free	LATEX SURGICAL GLOVES STERILE - box of 50 pairs
<b>25685</b>	<b>25695</b>	Size 6.5 - sterile
<b>25686</b>	<b>25696</b>	Size 7 - sterile
<b>25687</b>	<b>25697</b>	Size 7.5 - sterile
<b>25688</b>	<b>25698</b>	Size 8 - sterile
<b>25689</b>	<b>25699</b>	Size 8.5 - sterile

**COPOLYMER GLOVES ON PAPER**  
 Examination gloves, elasticized, for gynaecological use. MD class 1. AQL<1.5  
 Sterilized by irradiation (only 25709, 25710)

Non sterile box of 1,000*	Sterile** box of 100	COPOLYMER GLOVES
<b>25714</b>	<b>25709</b>	Medium
<b>25720</b>	<b>25710</b>	Large

\*10 packs of 100 \*\*individually packed

# SANTEX® AND DERMAGEL® LATEX GLOVES

## SANTEX® POWDERED - ambidextrous

Non-sterile, powdered, examination and protective glove for single use. Made of natural rubber latex. Smooth external surface guarantees a tactile sensitivity during the work. They minimize hand sweating. Enhanced tactile sensitivity. **AQL≤1.0**

## DERMAGEL® COATED - ambidextrous

Non-sterile, powder free, examination and protective gloves for single use. Made of natural rubber latex. The polymer layer inside ensures easy donning even on wet hands. **AQL≤1.0**



Creamy colour



2777

**21852**



Creamy colour



2777

**21857**

Multilingual box and instructions: GB, FR, IT, ES, PT, DE, PL, GR, SE, NO, FI, DK, SK, CZ, BG, RO, HU, HR, RS, SL, KZ, LT, LV, RU, TR.

Multilingual box and instructions: GB, FR, IT, ES, PT, DE, PL, GR, SE, NO, FI, DK, SK, CZ, BG, RO, HU, HR, RS, SL, KZ, LT, LV, RU, TR.

TECHNICAL SPECIFICATIONS	SANTEX®	DERMAGEL®
	External surface:	Smooth
Cuff:	_____	_____ beaded _____
MD (Medical Device):	_____	_____ Class I _____
PPE (Personal protective equipment):	_____	_____ Category III _____

Santex® Pre powdered	Dermagel® Powder free	LATEX GLOVES NON STERILE (box of 100)
<b>21851</b>	<b>21856</b>	Small size - non sterile
<b>21852</b>	<b>21857</b>	Medium size - non sterile
<b>21853</b>	<b>21858</b>	Large size - non sterile
<b>21854</b>	<b>21859</b>	Extra large size - non sterile

## GLOVE DISPENSER - STAINLESS STEEL

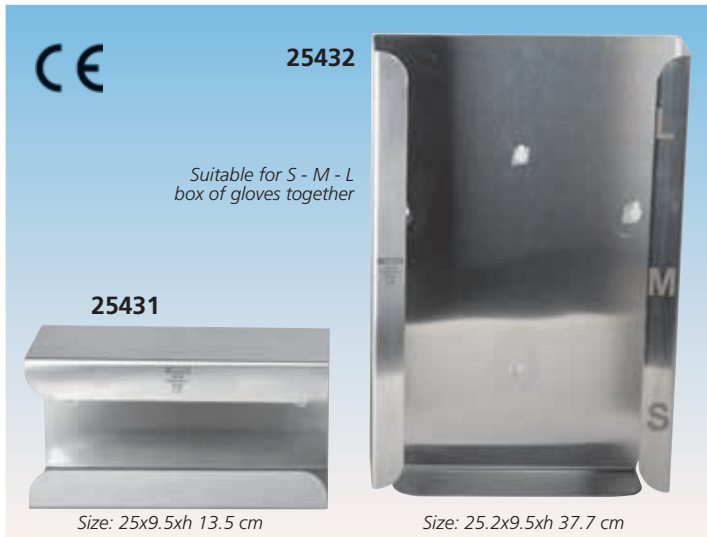

- **25431 GLOVE DISPENSER - single - stainless steel**
  - **25432 GLOVE DISPENSER - triple - stainless steel**
- Hold 1 or 3 standard boxes of 100 gloves.  
Made of AISI 304 stainless steel. Autoclavable at 121 to 134 °C.  
Can be easily hung to the wall and into ambulances.  
Screw included.

## GLOVE DISPENSER - PLASTIC



- **25430 GLOVE DISPENSER - plastic**
- Holds one box of 100 gloves.  
Made of unbreakable washable thermoplastic material.  
Fixed base and removable cover once the box of gloves needs to be replaced. Can be easily hung to the wall and into ambulance in vertical or horizontal position.  
Compatible with box of gloves up to 25.5x7xh 12 cm

## DRACULA

- **25700 DRACULA**
- Universal holder for gloves and tissue boxes, with little sharp teeth which automatically adjust to tightly hold any size of box.  
One-hand operation.



## COTTON GLOVES

100% cotton gloves. Extra long and coloured cuff for easy identification of the size.

GIMA code	Size	Cuff colour	Length cm		Weight g		Minimum order
			min	max	min	max	
25864	6.5	red	20	22	18	20	box of 10 pairs
25865	7	blue	21	23	19	21	box of 10 pairs
25866	7.5	green	23	25	21	23	box of 10 pairs
25867	8	white	24	26	23	25	box of 10 pairs
25868	8.5	orange	25	27	25	27	box of 10 pairs



## LATEX FINGER COTS

- **25941 LATEX FINGER COTS - medium**
  - **25942 LATEX FINGER COTS - large**
- Latex finger cots to cover 1 finger.  
Non sterile, single use, for finger protection, with talc.  
minimum order: 1.000 pcs. (10 bags of 100 pcs.)



## NON-WOVEN UNIFORM AND PANTS

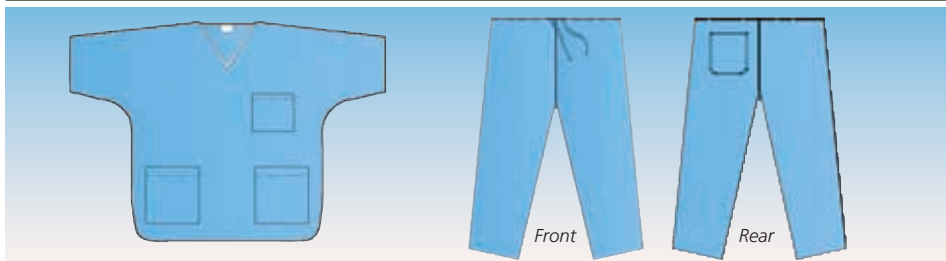

- **26076 UNIFORM COAT+PANT - S - box of 50**
- **26077 UNIFORM COAT+PANT - M - box of 50**
- **26078 UNIFORM COAT+PANT - L - box of 50**
- **26079 UNIFORM COAT+PANT - XL - box of 50**

## COLONOSCOPY PANTS



- **21030 COLONOSCOPY PANTS - box of 50**
- Colonscopy pants, one size, non sterile.  
Elastic waist, rear opening with velcro.  
Made of water-repellent non-woven SMS 35g/m<sup>2</sup>, dark blue, non transparent.

## DISPOSABLE KITS FOR PATIENT/VISITOR DRESSING - NON STERILE

- **26017 KIMONO - blue - box of 100**
- Opaque non-woven SMS kimono 30 g/m<sup>2</sup> with short-sleeves. Front opening and closing at the waist with laces.  
One size: length 120 cm, width 150 cm.

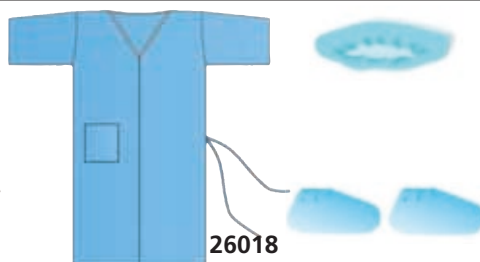
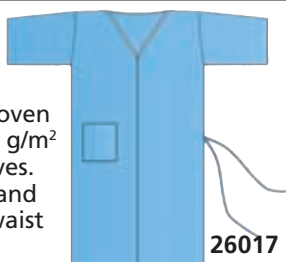

- **26018 PATIENT DRESSING KIT - box of 25**
- Kit includes kimono, round cap with elastic band and shoe-covers.



- **26019 VISITOR DRESSING KIT - box of 25**
- Kit includes gown for visitor, round cap with elastic band, three layers mask with ear loops, polyethylene shoe-covers.

# NON WOVEN SURGICAL SPECIALISTIC GOWNS - STERILE

## SURGICAL SPECIALISTIC GOWNS

Specialistic, water repellent, breathable gowns for a barrier effect to fluids and bacteria

- cotton cuffs 8 cm
- ultrasonic welding
- neck velcro closure
- 4 waist straps for internal and external closure

### Pre folded

For easy programmed dressing

### Welded reinforcement (only 21015, 21016)

Water-proof, breathable reinforcement on front and on sleeves ultrasonic welded.

All gowns include two dry-paper towels. Conforms to UNI EN ISO 13795.



21020-21023

**HIGH QUALITY**  
50 g/m<sup>2</sup>

MADE IN ITALY

GIMA code	SURGICAL GOWNS STERILE	Minimum order
<b>SURGICAL GOWNS 35 g</b>		
21010	Size M - length 115 cm	box 30
21011	Size L - length 130 cm	box 30
21012	Size XL - length 135 cm	box 30
<b>SURGICAL GOWNS 50 g</b>		
21020	Size M - length 120 cm	box 30
21021	Size L - length 130 cm	box 30
21022	Size XL - length 140 cm	box 30
21023	Size XXL - length 150 cm	box 30
<b>REINFORCED GOWNS 35 g</b>		
21015	Size L - length 130 cm	box 30
21016	Size XL - length 135 cm	box 30

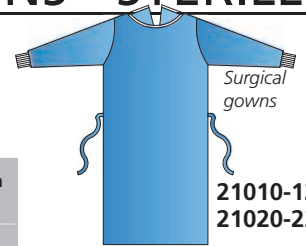

21010-12  
21020-23



21015-16

# SMMS DISPOSABLE SURGICAL GOWNS - NON STERILE OR STERILE

## SURGICAL GOWNS

Disposable surgical gowns that guarantee comfort and protection.

- fluid repellent
- abrasion resistant
- ultrasonic sewing
- book folding
- knitted cuff/velcro at neck
- anti microorganism and anti body fluids



21046-21049

**HIGH QUALITY**  
50 g/m<sup>2</sup>

- antistatic treatment
- great air permeability
- high strength and reliability
- reinforced pad 38 g (PP + PE) on the chest (50x70 cm 21052-21054 or 50x80 cm 21055) and sleeve (30 cm 21052-21054, or 40 cm 21055)
- set-in sleeve

Material: SMMS (spunbond + 2 meltblown + spunbond non wovens).

Weight per piece: 120 ± 2g  
Sterile gowns are individually packed.

Sterilized by oxide Ethylene.  
Multilingual instructions: GB, FR, IT, ES, PT, DE, GR, SE, RO, PL, Arabic.

GIMA code	SURGICAL GOWNS				Minimum order
	Size cm	Length cm	Width cm	Length of sleeve cm	
<b>SURGICAL GOWNS 40g - NON STERILE</b>					
21040	M	120	140	58	box of 100*
21041	L	120	150	59	box of 100*
21042	XL	130	150	59	box of 100*
21043	XXL	140	160	61	box of 100*
Packing size 66x35x43 cm. *10 pouches of 10 pieces					
<b>SURGICAL GOWNS 50g - STERILE</b>					
21046	M	120	140	58	box of 50
21047	L	120	150	59	box of 50
21048	XL	130	150	59	box of 50
21049	XXL	140	160	61	box of 50
Packing size 66x37x38 cm.					
<b>REINFORCED SURGICAL GOWNS 50g - STERILE</b>					
21052	M	120	140	58	box of 50
21053	L	120	150	59	box of 50
21054	XL	130	150	59	box of 50
21055	XXL	140	160	61	box of 50
Packing size 66x37x40 cm.					



**AAMI LEVEL 2**

21040-43  
21046-49



**AAMI LEVEL 3**

Reinforced gowns on chest and sleeves.

21052-55



Waist card for clear belt distinction

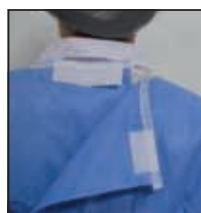

Velcro neckline

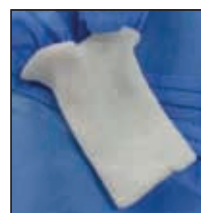

Knitted cuff 6.5 cm

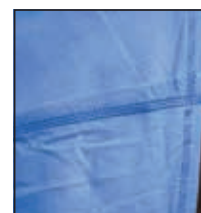

Ultrasonic sewing



4 waist ties 65 ±2 cm

# INSULATION GOWNS - WATERPROOF

## WATERPROOF DISPOSABLE GOWNS PP 25 g

It can be used in clinics, patient rooms, laboratory, check point, community...

Not suitable for ICU and operating room.

- collar with two ties
- cuffs with elastic
- long sleeve
- waist with ties

Packing size: 52x33x30 cm

Gross weight: approx. 6.8 kg

Multilingual instructions:

GB, FR, IT, ES, PT, DE, GR, SE, RO, PL, Arabic.

Sold in a box of 100 (10 pouches of 10 pieces).



Tie neckline (back)



Elastic cuff

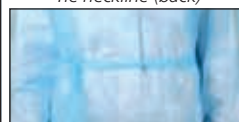

Front waist ties



Back waist ties



GIMA code	POLYTHENE GOWNS		Minimum order
	Size		
21131	Medium	115x137 cm	box of 100
21132	Large	120x150 cm	box of 100



21131

## DISPOSABLE INSULATION COVERALLS - TYPE 5B-6B AND TYPE 4B-5B-6B



### BASIC COVERALLS

Breathable, non-woven microporous coveralls with hood, elastic cuffs, elastic waist, zipper front.

#### Protection

Solid particulate resistant.

#### Applications

General outdoor duty, common insulation in out-patient service, inpatient ward, checkout room.

Each coverall is individually packed in a plastic bag. Multilingual instructions (GB, FR, IT, ES, PT, DE, GR, SE). Meet PPE (EU) 2016/425 CAT III



**TYPE 5B-6B**  
EN 14126 - EN 13034



### TAPED SEAM COVERALLS

Breathable, non-woven microporous coveralls with hood, with taped seam, elastic cuffs, elastic waist, zipper front.

#### Protection

Dust proof, dry particulate/light spray/virus and blood permeate resistant.

#### Applications

Apply to General field, medical institutions outpatient, ward, laboratory and other common insulation use.

Each coverall is individually packed in a plastic bag. Multilingual instructions (GB, FR, IT, ES, PT, DE, GR, SE). Meet PPE (EU) 2016/425 CAT III



**TYPE 4B-5B-6B**  
EN 14605 - EN 14126  
EN 13034



TYPE 5B - 6B BASIC COVERALLS - 60 g			
GIMA code	Size	Chest (cm)	Height (cm)
21070	Size S	84-92	164-170
21071	Size M	92-100	170-176
21072	Size L	100-108	176-182
21073	Size XL	108-116	182-188
21074	Size XXL	116-124	188-194

TYPE 4B - 5B - 6B TAPED SEAM COVERALLS - 60 g			
GIMA code	Size	Chest (cm)	Height (cm)
21080	Size S	84-92	164-170
21081	Size M	92-100	170-176
21082	Size L	100-108	176-182
21083	Size XL	108-116	182-188
21084	Size XXL	116-124	188-194

TYPE-4B, spray-tight seams, offer protection against saturation of liquid chemicals  
TYPE-5B, against solid dust, provide protection to the full body against airborne solid particulates  
TYPE-6B, against minor splashing, offer limited protection against a light spray of liquid

## MICROPOROUS BOOT COVERS - TYPE 5B-6B AND TYPE 4B-5B-6B



**TYPE 5B-6B**  
EN 14126

**TYPE 4B-5B-6B**  
EN 14126

21090

Size 45x36x26 cm

PVC antislip sole

21091

Size 45x40x26 cm

21092

Size 45x36x26 cm

- 21090 BOOT COVERS - TYPE 5B-6B - box of 500 (25 bags of 20 pcs)
  - 21091 BOOT COVERS - TYPE 5B-6B - with antislip sole - box of 40
  - 21092 TAPED SEAM BOOT COVERS - TYPE 4B-5B-6B - box of 20
- Microporous disposable boot covers for general purposes as: cleanrooms, hospitals, labs, food industry, medical and pharmaceutical. Optimized body fit and lightweight (60 g) to improve comfort and safety. The PP material provides high level of comfort and protection against solid particles such as dust.

#### Features:

- PP + PE, microporous
- breathable and dust proof
- liquid penetration resistance
- barrier to fine particulates
- air and water vapor permeable to reduce risk of heat stress and fiber contamination
- with ties, elastic open.

Multilingual instructions: GB, FR, IT, ES, PT, DE, GR, SE.



## SHOE COVERS

- 21094 SHOE COVER - box of 2000 (20 bags of 100)
  - 21095 ANTI-SKID SHOE COVER - box of 1000 (10 bags of 100)
- made of lightweight PP  
- with elastic band  
- anti-skid model with elastic and printing at the bottom (21095)  
- size: 17x40 cm (21094), 15x40 cm (21095) - light, only 35 g



21094

ANTI-SKID

21095

## CAPS WITH ELASTIC OR TIES

- 21097 CAP WITH ELASTIC - box of 1000 (10 bags of 100)
  - 21098 CAP WITH TIES - box of 1000 (10 bags of 100)
- operating cap made of SMS  
- size: 62x14,5 cm  
- light, 35 g (21097) or 40 g (21098)  
- breathable and waterproof



21097

Cap with elastic

21098

Cap with ties

# DOCTOR'S WHITE COATS, JACKETS, TROUSERS - 100% COTTON



## 100% COTTON DOCTOR'S WHITE COATS

Professional and stylish line with all sizes for men and women, made of high quality 100% cotton.

Doctor's white coats have 2 side pockets, 1 breast pocket, half belt and back slit. Woman and man models have buttons, unisex model has press studs and elasticated cuffs.

Oeko-Tex® 100 certified. Weight 185 g/m<sup>2</sup>.

## 100% COTTON JACKETS AND TROUSERS

Stylish unisex line made of high quality 100% cotton.

Jacket with V-neck, half sleeves, side slits, two front and one breast pockets. Trousers with elasticated waist, three patch pockets, bottom hem.

White jackets 185 g/m<sup>2</sup>, coloured jackets 190g/m<sup>2</sup>.

Oeko-Tex® 100 certified.

### DOCTOR'S WHITE COATS 100% COTTON

Size			Woman	Man	Unisex
Europe	USA	France	with button	with button	with press stud
40	XS	36	26110	-	26080
42	S	38	26111	-	26081
44	S	40	26112	26098	26082
46	M	42	26113	26101	26083
48	M	44	26114	26102	26084
50	L	46	26115	26103	26085
52	L	48	26116	26104	26086
54	XL	50	26117	26105	26087
56	XL	52	-	26106	26088
58	XXL	54	-	26107	26089



### JACKETS - UNISEX

Size	White	Green	Blue indigo	Fantasy
XS	26124	26126	26128	-
S	26130	26140	26150	26170
M	26131	26141	26151	26171
L	26132	26142	26152	26172
XL	26133	26143	26153	26173
XXL	26134	26144	26154	-

### TROUSERS - UNISEX

XS	26125	26127	26129	-
S	26135	26145	26155	-
M	26136	26146	26156	-
L	26137	26147	26157	-
XL	26138	26148	26158	-
XXL	26139	26149	26159	-



## SURGICAL GOWNS

### THEATRE SURGICAL GOWNS

Surgical gowns for men and women made of high quality 100% cotton. Crewneck, two cords for internal rear closure at the waist, long raglan sleeves with cotton jersey cuffs. Weight 185 g/m<sup>2</sup>.



### THEATRE GOWNS - GREEN

Size	Man-woman
52-56	26162
58-62	26163

## DENTAL JACKETS

### DENTAL JACKETS

Short sleeves round-necked jacket with 2 buttons on right shoulder and 5 hidden buttons. One pocket and one breast pocket. Green colour 100% pure cotton.



### DENTAL JACKET

Size	Unisex green
XS	21000
S	21001
M	21002
L	21003
XL	21004
XXL	21005

# DOCTOR'S WHITE COATS, JACKETS, TROUSERS - COTTON/POLYESTER

DOCTOR'S WHITE COATS



**DOCTOR'S WHITE COATS 60% COTTON - 40% POLYESTER**  
 Professional and stylish line with all sizes for men and women, made of 60% high quality cotton and 40% polyester. Doctor's white coats have 2 side pockets and 1 breast pocket. Man and woman model have buttons, unisex model has hidden press studs and elasticated cuffs.  
 Weight 200 g/m<sup>2</sup>



DOCTOR'S WHITE COATS 60% COTTON - 40% POLYESTER					
Size			Woman	Man	Unisex
Europe	USA	France	with button	with button	with press stud
38-40	XS	36	21401	-	21421
42-44	S	38-40	21402	21412	21422
46-48	M	42-44	21403	21413	21423
50-52	L	46-48	21404	21414	21424
54-56	XL	50-52	21405	21415	21425
58-60	XXL	54-56	-	21416	21426
62-64	XXXL	58-60	-	21417	21427

**JACKETS AND TROUSERS 60% COTTON - 40% POLYESTER**  
 Professional and stylish line with all sizes for men and women, made of 60% high quality cotton and 40% polyester. Stock in 5 colours, other 22 colours available in 60 days. White jacket 200 g/m<sup>2</sup>, coloured jacket 185 g/m<sup>2</sup>.

**• 21398 EMBROIDERY\* ON COTTON-POLYESTER COATS/JACKETS**

\*1 or 2 colour logo, size 8-10 x 2-3 cm on coats and jackets



JACKETS - UNISEX				
Size	White	Green	Light Blue	Colour on request**
XS	21431	21441	21451	21471
S	21432	21442	21452	21472
M	21433	21443	21453	21473
L	21434	21444	21454	21474
XL	21435	21445	21455	21475
XXL	21436	21446	21456	21476
XXXL	21437	-	21457	21477

JACKETS WITH PRESSURE STUD							
Size	Woman			Unisex			
	White	Violet	Colour on request*	White	Blue navy	Light blue	Colour on request**
XS	21561	21571	21591	21601	21611	21621	21651
S	21562	21572	21592	21602	21612	21622	21652
M	21563	21573	21593	21603	21613	21623	21653
L	21564	21574	21594	21604	21614	21624	21654
XL	21565	21575	21595	21605	21615	21625	21655
XXL	21566	21576	21596	21606	21616	21626	21656

TROUSERS - UNISEX						
Size	White	Violet	Blue navy	Light blue	Green	Colour on request**
XS	21491	21521	21531	21511	21501	21551
S	21492	21522	21532	21512	21502	21552
M	21493	21523	21533	21513	21503	21553
L	21494	21524	21534	21514	21504	21554
XL	21495	21525	21535	21515	21505	21555
XXL	21496	21526	21536	21516	21506	21556
XXXL	21497	-	-	21517	-	21557

**TECHNICAL SPECIFICATIONS**  
 Composition: 60% cotton - 40% polyester  
 Weight: 200 g/m<sup>2</sup> (white), 185 g/m<sup>2</sup> (coloured)  
 Yarn count: warp: Ne 20 ± 2 weft: Ne 18 ± 2  
 Construction: warp: 40 ± 3 weft: 19 ± 3  
 Breaking strength - warp: 100 kg ± 3%  
 Breaking strength - weft: 39 kg ± 3% (white), 49 kg ± 3% (coloured)  
 Fastness to washing: 4  
 Treatments and finishing: crease resist  
 Dimensional stability - washing at 90°C: 3%

**22 COLOURS ON REQUEST\*\* (JACKETS AND TROUSERS)**



\*\*Available in 60 days. Specify size and colour with order. Minimum order 100 mixed pieces same colour.

# ANTISTATIC CLOGS - AUTOCLAVABLE AT 134°C

**UPPER WITHOUT PORES**



**EN ISO 20347 A-E**

MADE IN ITALY

Lateral pores for breathability

26331 - 26342

**UPPER WITH PORES**



Movable strap

26451 - 26462

Multilingual box:  
GB, FR, IT, ES, PT,  
DE, GR, Arabic

Lateral pores for breathability

**WITH STRAP WITHOUT PORES**



26231 - 26242

## GIMA PROFESSIONAL CLOGS

- active arch support to stimulate circulation
- antistatic material directly injected in the polymeric blend
- perforated sole for breathability and transpiration
- antislip grooved sole safe on wet floor
- machine washable, sterilizable at 134°C
- available also with strap for extra security
- individually packed in carton box
- latex free

**4 MODELS**

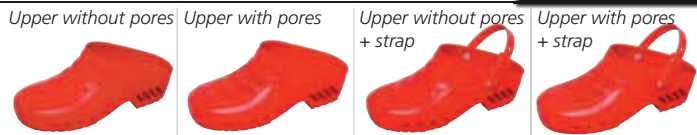

**EVERY MODEL IN 13 COLOURS - 12 SIZES**

- 26463 CLOGS WITHOUT STRAP - other colours
- 26292 CLOGS WITH STRAP - other colours

(minimum order for non-coded products: 50 pairs)



Size	UPPER WITHOUT PORES						UPPER WITH PORES					
	White	Green	Electric Blue	Orange	Fuchsia	White with strap	Blue with strap	Red with strap	White	Blue	Green with strap	
34	26311	26331	26351	26371	-	26231	26261	-	26411	26451	26471	
35	26312	26332	26352	26372	26392	26232	26262	26282	26412	26452	26472	
36	26313	26333	26353	26373	26393	26233	26263	26283	26413	26453	26473	
37	26314	26334	26354	26374	26394	26234	26264	26284	26414	26454	26474	
38	26315	26335	26355	26375	26395	26235	26265	26285	26415	26455	26475	
39	26316	26336	26356	26376	26396	26236	26266	26286	26416	26456	26476	
40	26317	26337	26357	26377	26397	26237	26267	26287	26417	26457	26477	
41	26318	26338	26358	26378	26398	26238	26268	26288	26418	26458	26478	
42	26319	26339	26359	26379	26399	26239	26269	26289	26419	26459	26479	
43-44	26320	26340	26360	26380	26400	26240	26270	26290	26420	26460	26480	
45-46	26321	26341	26361	26381	-	26241	26271	26291	26421	26461	26481	
47-48	26322	26342	26362	26382	-	26242	26272	-	26422	26462	26482	



# IMPERMEABLE, ABSORBENT, ANTI-SLIP MAT FOR FLOORS

## IMPERMEABLE ANTI-SLIP ABSORBENT BLUE COLOUR MAT FOR FLOORS

Pre-cut or roll mats to be positioned on the floor of the operating room or near the sink in the pre-operating theatre for holding liquids that could fall on the floor. Mats have high absorbent capacity and optimal speed absorbency. The mats distribute the absorbed liquid by capillary method and maintain it at his internal structure avoiding the lifts on



25166 + 25169

25169

surface. The special film at rear side blocks the mat on the floor and keeps it stopped without using adhesive matters, which could release glue traces on the floor. They are perfectly adherent to the ground, avoiding risk of accidents.

### Absorbent rolls

They have 3 different absorbences. Can be cut at desired size.

### Trolley for rolls

Made of stainless steel with 4 pivoting wheels (2 with brake). Turning base, for rolls with height up to 1 m.

GIMA code	ABSORBENT PRE-CUT MATS		Minimum order
	Size	Absorbence	
25150	90x90 cm	1,700 ml/m <sup>2</sup>	box of 70
25151	90x120 cm	1,700 ml/m <sup>2</sup>	box of 50
25152	90x150 cm	1,700 ml/m <sup>2</sup>	box of 40
25153	90x200 cm	1,700 ml/m <sup>2</sup>	box of 30
25154	90x250 cm	1,700 ml/m <sup>2</sup>	box of 20
ABSORBENT ROLLS			
25165	90 cm x 50 m	1,700 ml/m <sup>2</sup>	1
25166	90 cm x 50 m	2,500 ml/m <sup>2</sup>	1
25167	90 cm x 50 m	3,500 ml/m <sup>2</sup>	1
TROLLEY FOR ROLLS			
25169	Trolley for absorbent rolls		1



## ULTRA LIGHT CLOGS WITH STRAP

200 g ONLY  
PER PAIR



26190-26203

Multilingual box: GB, FR, IT, ES, PT, DE, NL, PL, RO, SE, GR, Arabic



### GIMA ULTRA LIGHT CLOGS

Protective clogs meeting requirements of working shoes norms EN ISO 20347 A E SRC

- **extremely light:** only 200 g per pair
- **aerated:** lateral holes provide aeration, avoid liquid dropping in
- **anatomic:** respect foot anatomy
- **antishock:** maximum energy absorption in the heel zone
- **antislip:** the unique design of the sole's tread meet the SRC requirements regarding the slipping resistance
- **antistatic:** antistatic non marking element in the heel zone working even after many washing
- **washable up to 50°C:** with normal neutral detergents, resistant to chemicals or UV sterilizations
- **antibacterial, antimould, antifungus**
- **latex free**

• 26206 ULTRA LIGHT CLOGS - other colour - minimum 50 pairs (available in light blue, orange, black)

ULTRA LIGHT CLOGS				
Size	White	Blue	Green	Fuchsia
34	26190	26210	26175	-
35	26191	26211	26176	26224
36	26192	26212	26177	26225
37	26193	26213	26178	26226
38	26194	26214	26179	26227
39	26195	26215	26180	26228
40	26196	26216	26181	26229
41	26197	26217	26182	26230
42	26198	26218	26183	-
43	26199	26219	26184	-
44	26200	26220	26185	-
45	26201	26221	26186	-
46	26202	26222	26187	-
47	26203	26223	26188	-

## PROFESSIONAL ULTRALIGHT SHOES



100%  
Italian design  
Italian material

200 g ONLY



20000 - 20013



20020 - 20033

Multilingual box: GB, FR, IT, ES, PT, DE, GR, Arabic

### GIMA ULTRA LIGHT SHOES

Protective shoes meeting requirements of working shoes norms EN ISO 20347: A E SRC

- **extremely light:** only 200 g per pair
- **aerated:** lateral holes provide aeration but avoid liquid dropping in
- **anatomic:** respect natural foot anatomy
- **antishock:** maximum energy absorption in the heel zone
- **antislip:** the unique design of the sole's tread meet the SRC requirements regarding the slipping resistance
- **antistatic:** antistatic non marking element in the heel zone working even after many washings
- **washable up to 50°C:** with normal neutral detergents, resistant to chemicals or UV sterilizations used in hospitals
- **antibacterial, antimould, antifungus**
- **latex free**

### ULTRA LIGHT SHOES

Size	White	Blue
34	20000	20020
35	20001	20021
36	20002	20022
37	20003	20023
38	20004	20024
39	20005	20025
40	20006	20026
41	20007	20027
42	20008	20028
43	20009	20029
44	20010	20030
45	20011	20031
46	20012	20032
47	20013	20033

## BREATHABLE AND ANTISTATIC SNEAKERS FOR PROFESSIONAL USE

20100 - 20113

HF100  
professional sneakers  
with elastic laces



Designed in Italy



HF200  
professional sneakers  
with velcro strap

20140 - 20153

### PROFESSIONAL SNEAKERS

Professional SNEAKERS made of breathable microfibre fabric.

#### Features:

- breathable lining
- quick fastening for greater comfort
- EVA LEVIREX® sole with antistatic insert
- removable and antistatic insole made of bi-density PU
- suitable for machine washing up to 40°C

#### PPE category II

Safety footwear for professional use according to harmonized standard EN ISO 20347:2012

### SNEAKERS

Size	HF100 laces	HF200 strap
34	20100	20140
35	20101	20141
36	20102	20142
37	20103	20143
38	20104	20144
39	20105	20145
40	20106	20146
41	20107	20147
42	20108	20148
43	20109	20149
44	20110	20150
45	20111	20151
46	20112	20152
47	20113	20153



Hospital



Unisex



Non slip



Anatomical



Super lightweight



Waterproof



Antistatic



Washable



Approved

# FUNNY CAPS

MADE IN ITALY

Wide range of patterned caps. Light and comfortable, provided with adjustable laces. Available in two sizes: medium (M), suggested for men and women with short or medium-long hair; large (L), suggested for women with long, curly hair. 100% high quality pure cotton, highly breathable surgical caps. MD Class I. Multilingual instructions: GB, FR, IT, ES, PT, DE, GR, PL, CZ, RO, SE.

### OTHER PATTERNS ON REQUEST

Select pattern from

<https://123rf.com/clipart-vector/>

- 20800 FUNNY CAP - M - other patterns
- 20900 FUNNY CAP - L - other patterns

Minimum order 200 pieces. Available in 30 days.



20827



20816



20903



• 20801 FLAMINGO - M  
• 20901 FLAMINGO - L



• 20802 FOOTSTEP - M  
• 20902 FOOTSTEP - L



• 20803 CORAL - M  
• 20903 CORAL - L



• 20804 CHILDREN - M  
• 20904 CHILDREN - L

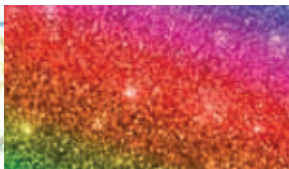

• 20805 BRIGHT - M  
• 20905 BRIGHT - L



• 20806 TURTLE - M



• 20807 REEF - M



• 20808 FISH - M



• 20809 PEACE - M



• 20810 COLOUR - M



• 20811 DAISY - M



• 20812 TROPICAL - M



• 20813 HAWAII - M



• 20814 CASHMERE - M



• 20815 STARS - M



• 20816 MILITARY - blue - M

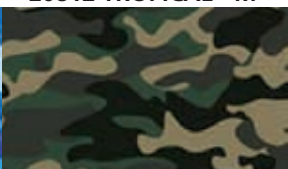

• 20817 MILITARY - green - M



• 20818 SKULL - M



• 20819 RAINBOW - M



• 20820 WAVE - M



• 20821 SMILE PET - M



• 20822 DOG - M

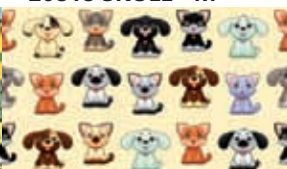

• 20823 PET - M



• 20824 VETERINARY - M



• 20825 DINO - M



• 20826 TOY - M



• 20827 SPACE - M



• 20828 MACARONES - M



• 20829 CHRISTMAS - M



• 20830 HALLOWEEN - M



• 20831 DENTAL - M



• 20832 MEDICAL - M

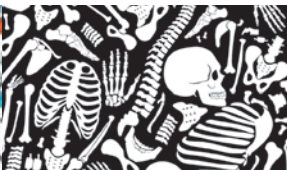

• 20833 SKELETON - M

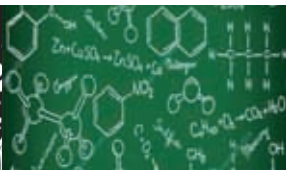

• 20834 CHEMICAL - M



• 20835 BIOLOGY - M

# SURGICAL CAPS

MADE IN ITALY

Cotton surgical patterned or green caps.

- 26166 GREEN CAP
- 26165 FANTASY CAP - light blue
- 26167 FANTASY CAP - beige
- 26168 FANTASY CAP - red

Other colour on request. Minimum order 1,000 pieces.



26165



26166



26167



26168

## SILICONE NURSE WATCHES



20400 20401 20402 20403 20404 20405

**NURSE WATCHES**  
Silicone nurse watches, provided with a safety pin.  
Suitable to measure patient pulse, beat and sterilization procedure timing.  
Conforming to procedures not allowing nurses to wear wrist watches.  
Watch case 35 mm, watch length 85 mm.  
Shelf life of battery: 18 months from first use.  
Manual: GB, FR, IT, ES, PT, DE, GR, PL, Arabic.



Safety pin on back  
20403



20411

SILICONE WATCHES		SILICONE WATCHES	
GIMA code	Round - single colour	GIMA code	Round - single colour with aluminium box
20400	White	20410	White
20401	Blue	20411	Blue
20402	Red		Square - single colour with aluminium box
20403	Purple	20455	Blue
20404	Pink		
20405	Black		
	Round - multicolour		Square - multicolour
20420	Red & white	20460	Violet and sky blue
20421	Patchwork	20461	Hearts
20422	Zebra	20462	Flowers
20423	Bubbles	20463	Leopard
20424	Leaves	20464	Roses
20425	Caterpillar	20465	Foot print
	Silicone straps - spare		Digital**
20418	Kit of 6 silicone straps*	20480	Blue

\*Spare silicone straps for round watches

\*\*Manual: GB, FR, IT, ES

20480



20420 20421 20422 20423 20424 20425

20460 20461 20462 20463 20464 20465

## NURSE STAINLESS STEEL SCISSORS AND FORCEPS



20513 20500 20512

Nurse bandage scissors - 14 cm



20542 20551 20552

Straight artery forceps - 16 cm



20521 20529 20520

Straight scissors blunt/sharp - 14 cm

Model	BANDAGE* SCISSORS 14 cm	SCISSORS 18 cm	STRAIGHT* SCISSORS - 14 cm	ARTERY* FORCEPS - 16 cm
Standard	34129**	34130	26725***	26717
Standard with belt clip	20500	-	20520	-
Green ring	20501	-	20521	20541
Lilac ring	20502	-	20522	20542
Foot print	20509	-	20529	20549
Leopard	20511	-	20531	20551
Bubbles	20512	20492	20532	20552
Hearts	20513	-	20533	20553
Caterpillar	20514	20494	20534	-

\*These powder coated instruments are not autoclavable, can be sterilized in water at maximum 110°C

\*\*16 cm

\*\*\*14.5 cm

## STAINLESS STEEL UTILITY AND BANDAGE SCISSORS



20581 20582 20573 20574 20560

Plastic coloured finger-contour handles for maximum comfort.

All purpose, first aid scissors, easily cut bandages, leather and plaster casts. Autoclavable at 136°C. Instructions: GB, FR, IT, ES, PT, DE.

UTILITY SCISSORS - box of 10			
12 cm - 4.7"	16.5 cm - 6.5"	19 cm - 7.5"	Colour
20560	20570	20580	Black
-	20571	20581	Blue
-	20572	20582	Red
-	20573	20583	Purple
-	20574	20584	Pink
20590	Steel chain for scissors and forceps		



20590

## BI-LAYER NON-WOVEN FABRIC STERILE SURGICAL DRAPES

DRAPES



DRAPES WITH ADHESIVE SIDE



DRAPES WITH CENTRAL ADHESIVE HOLE

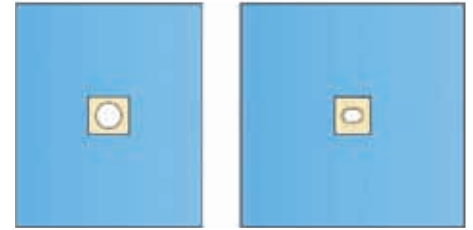

All surgical drapes are made of light-blue bi-layer water-proof non-woven fabric 54 g/m<sup>2</sup>. Individually packed in PE bag, sterile (Ethylene oxide), latex free

Drape with hole Ø 10 cm

Drape with hole 6x9 cm

GIMA code	DRAPES	Minimum order
23600	Drape 50x50	box of 100
23601	Drape 50x75	box of 100
23602	Drape 75x90	box of 75
23604	Drape 100x100	box of 50
23606	Drape 120x150	box of 50
23608	Drape 150x200	box of 25

GIMA code	DRAPES WITH ADHESIVE SIDE	Minimum order
23610	Drape 50x50	box of 100
23611	Drape 50x75	box of 100
23612	Drape 75x90	box of 75
23614	Drape 100x100	box of 50
23617	Drape 180x200	box of 25
23618	Drape 150x240	box of 25

GIMA code	DRAPES WITH CENTRAL ADHESIVE HOLE	Minimum order
23620	Drape 50x75 - hole 6x9 cm	box of 75
23622	Drape 75x90 - hole 6x9 cm	box of 75
23623	Drape 75x90 - hole Ø 10 cm	box of 75
23624	Drape 100x100 hole Ø 10 cm	box of 50
23625	Drape 100x150 - hole 9x18 cm	box of 25
23626	Drape 120x150 - hole Ø 10 cm	box of 25

## NON-WOVEN FABRIC STERILE OPHTHALMIC SURGERY DRAPES

Hole 6x9 cm with incision film. Single bag to receive fluids and adaptable bar.

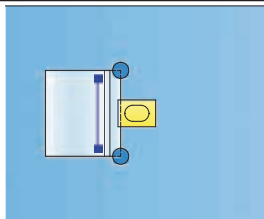

Hole 10x10 cm with incision film. Double bag to receive fluids with adaptable bar

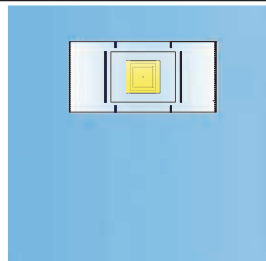

Hole Ø11 cm with incision film. Double bag 35x73 cm to receive fluids with adaptable bar for nasal septum. Wrapped in crepe paper.

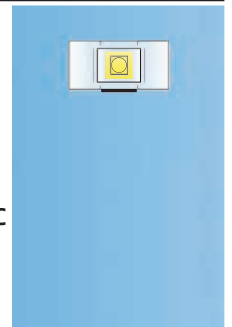

• 23634 OPHTHALMIC SURGERY DRAPE 80x100 cm - sterile - box of 40

• 23635 OPHTHALMIC SURGERY DRAPE 160x160 cm - sterile - box of 15

• 23636 OPHTHALMIC SURGERY DRAPE 160x260 cm - sterile - box of 10

## SURGERY COTTON DRAPES



- 26495 DRAPE 90x150 cm
  - 26496 DRAPE 150x150 cm
  - 26497 DRAPE 250x150 cm
- Made of 100% high quality cotton, green colour.  
Made in Europe.

## INCISION FILM - STERILE

Its purpose is to define the anatomic part of the patient where the surgery will be done. It is applied at the point where the wound is, to protect it from possible contamination. Incision film made of adhesive polyurethane.

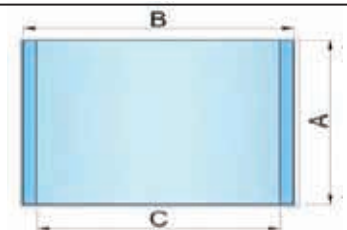

GIMA code	SIZE AxB	SIZE AxC	Minimum order
23628	45x50 cm	45x40 cm	box of 10
23630	30x35 cm	30x25 cm	box of 50
23631	45x50 cm	45x40 cm	box of 50
23632	60x65 cm	60x55 cm	box of 50

## POLYESTER OR MICROFIBRE SURGERY DRAPES

### 100% TEXTURIZED POLYESTER DRAPES

Studied for replacing the classic cotton drape in operating rooms.

Advantages:

- it does not have particles release of dust or cotton fibers that could cause infections during surgery
- various usability on the field:
  - as a sheet under the patient
  - as a towel
  - to tamponage, considering its high absorbency
  - as a pre or post surgery cover, thanks to the capability of keeping a good body temperature

Polyester texturized fabric

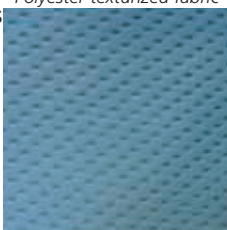

- 41000 POLYESTER DRAPE 90x150 cm - light blue
- 41001 POLYESTER DRAPE 150x150 cm - light blue
- 41002 POLYESTER DRAPE 250x150 cm - light blue

### MICROFIBRE DRAPES

(99% polyester + 1% carbon fibre)

The microfibre line is conceived for operating room.

The characteristics and abilities are various:

- the fabric does not absorb liquids, maintaining the operating field dry;
- the fabric does not have particles release of dust or fibre that could cause infections on the patient.

GIMA fabric is composed of polyester and carbon fibres. The addition of carbon fibres serves as protection from potential electric discharges.

- 41009 MICROFIBRE DRAPE 90x150 cm - green
- 41010 MICROFIBRE DRAPE 150x150 cm - green
- 41011 MICROFIBRE DRAPE 250x150 cm - green

Microfibre fabric



Sizes of drapes may vary ±5% due to fabric processing during production phase

# STERILE SURGERY SETS

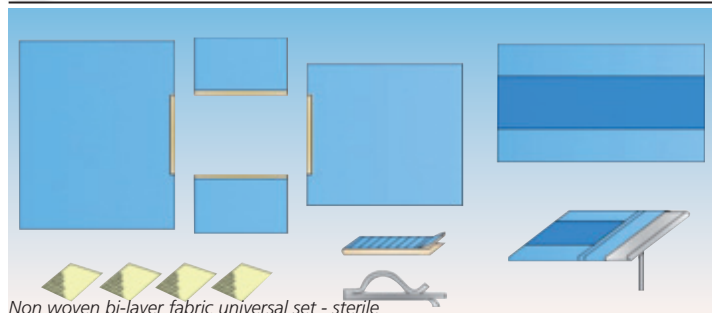

Non woven bi-layer fabric universal set - sterile

- **23640 UNIVERSAL SET - sterile - box of 10**
- 1 table cover 150x200 cm with central absorbent band
- 1 Mayo stand cover 80x145 cm
- 1 standard surgical drape, 150x240 cm with adhesive tape
- 1 standard surgical drape, 180x200 cm with adhesive tape
- 2 standard surgical drapes, 75x90 cm with adhesive tape
- 4 towels 35x40 cm
- 1 adhesive strip 10x50 cm
- 1 tube holder 2.5x20 cm

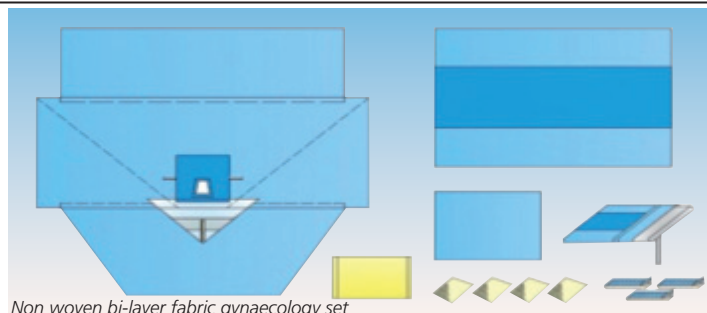

Non woven bi-layer fabric gynaecology set

- **23641 GYNAECOLOGY SET - sterile - box of 8**
- 1 table cover 150x200 cm with central absorbent band
- 1 Mayo stand cover 80x145 cm
- 1 gynaecology drape for lithotomy position 290x240 cm with adhesive hole, built-in
- leggings, bag for liquid collection with filter and drain valve
- 1 drape 75x90 cm
- 1 incision film 35x50 cm
- 3 adhesive strips 10x50 cm
- 4 towels 35x40 cm



Non woven bi-layer fabric orthopaedy set for knee arthroscopy - sterile

- **23642 SET FOR KNEE ARTHROSCOPY - sterile - box of 8**
- 1 table cover 150x200 cm with absorbent central band
- 1 Mayo stand cover 80x145 cm
- 1 standard surgical drape, 150x180 cm
- 1 orthopaedy drape for arthroscopy at knee 230x320 cm with elastic hole and bag for liquid collection
- 1 stockinette 22x75 cm
- 3 adhesive strips 10x50 cm
- 4 towels 35x40 cm

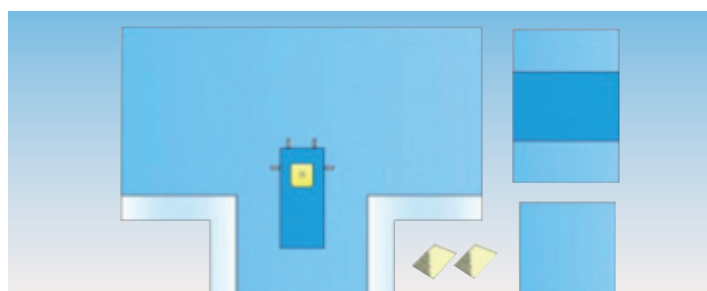

Non woven SMS fabric orthopaedy set for hand surgery - sterile

- **23643 SET FOR HAND SURGERY - sterile - box of 8**
- 1 table cover 100x150 cm with central absorbent band
- 1 standard surgical drape, 100x100 cm
- 2 towels 35x40 cm
- 1 T-shape drape for hand surgery 370x190x290 cm with elastic hole 5 cm and cable fixing Velcro strips

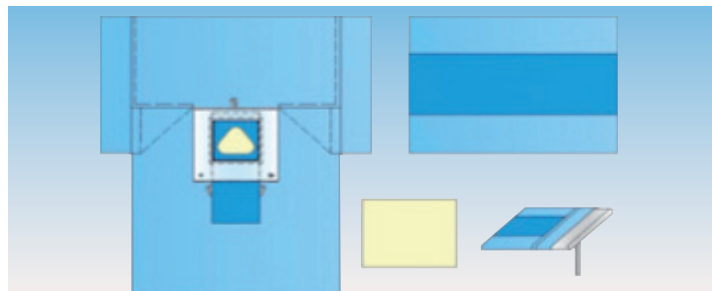

Non woven SMS fabric obstetrics set for caesarean section - sterile

- **23644 SET FOR CESAREAN SECTION - sterile - box of 8**
- 1 table cover 150x200 cm with central absorbent band
- 1 Mayo stand cover 80x145 cm
- 1 drape for caesarean section 260x200x310 cm with incision film and bag for liquid collection
- 1 drape "baby blanket" 75x90 cm

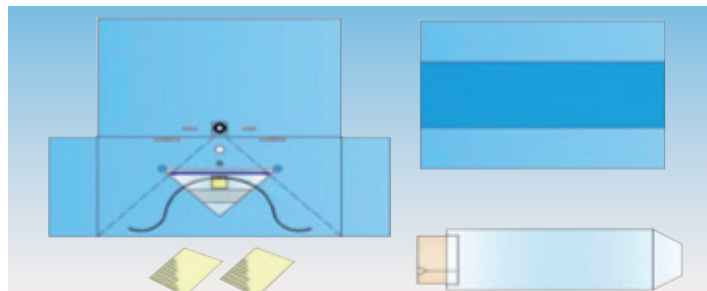

Non woven SMS fabric urology set for TUR - sterile

- **23645 UROLOGY SET FOR TUR - sterile - box of 8**
- 1 table cover 100x150 cm with central absorbent band
- 1 urology drape for TUR, 200x280x220 cm with perineal and subpubic holes,
- bag for liquid collection with filter, adhesive tape and straps
- 1 camera drape 13x250 cm
- 2 towels 35x40 cm



Made of non-woven bi-layer fabric. Polypropylene band

- **23650 Table cover 150x200 cm - sterile - box of 20**



- **23651 Mayo stand cover 80x145 cm - sterile - box of 40**

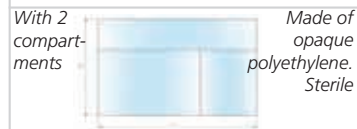

- **23654 Adhesive pocket for tools 35x42 cm - box of 100**

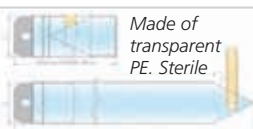

- **23655 Camera drape 13x250 cm - box of 100**

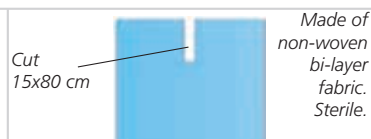

Made of non-woven bi-layer fabric. Sterile.

- **23652 Drape, 200x240 cm with adhesive U shape cut - box of 15**



Made of non-woven bi-layer fabric. Sterile.

- **23653 Pair of leggings 75x130 cm for urology/gynaec. - box of 20**

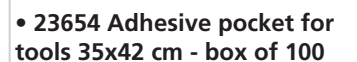

Made of opaque polyethylene. Sterile

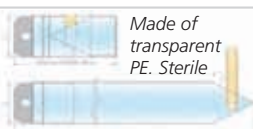

Made of transparent PE. Sterile



Made of transparent PE. Sterile.

- **23656 Bag to cover instruments 75x90 cm - box of 100**



Sterile

- **23657 Adhesive strip 10x50 cm - box of 200**

# TUNGSTEN CARBIDE INSTRUMENTS - GOLD LINE

## GOLD LINE - TUNGSTEN CARBIDE INSTRUMENTS

A top quality theatre use Tungsten Carbide Instruments made of stainless steel AISI 410 (AISI 420 for scissors) with very hard tips made in Germany to help surgeons perform precision surgeries with best results. Highly reliable for hardness and corrosion resistance. Instructions: GB, FR, IT, ES, PT, DE, GR, Arabic.



### TUNGSTEN CARBIDE NEEDLE HOLDERS - AISI 410

### TC MICRO NEEDLE HOLDER - AISI 410



26544 Webster needle holder - 12.5 cm



26540 Olsen Hegar needle holder - 14 cm  
26541 Olsen Hegar needle holder - 16.5 cm  
26542 Olsen Hegar needle holder - 19 cm



26550 Castroviejo Needle Holder straight - 14 cm - plain tip  
26552 Castroviejo Needle Holder curved - 14 cm - plain tip  
26553 Castroviejo Needle Holder straight - 14 cm - rough tip  
26555 Castroviejo Needle Holder curved - 14 cm - rough tip  
26551 Castroviejo Needle Holder straight - 18 cm - rough tip  
26556 Castroviejo Needle Holder straight - 21 cm - rough tip  
26557 Castroviejo Needle Holder curved - 21 cm - rough tip



26546 Crile Wood needle holder - 15 cm  
26547 Crile Wood needle holder - 18 cm  
26545 Crile Wood needle holder - 20 cm



26536 Mathieu needle holder - 14 cm  
26537 Mathieu needle holder - 17 cm  
26538 Mathieu needle holder - 20 cm



26554 Castroviejo - 13 cm



26539 Mayo Hegar needle holder - 14 cm  
26530 Mayo Hegar needle holder - 16 cm  
26531 Mayo Hegar needle holder - 18 cm  
26532 Mayo Hegar needle holder - 20 cm  
26535 Mayo Hegar needle holder - 24 cm  
26533 Mayo Hegar needle holder - 26 cm  
26534 Mayo Hegar needle holder - 30 cm

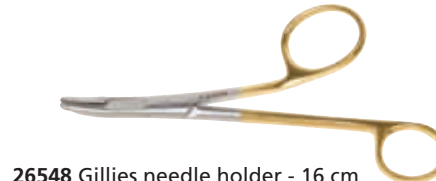

26548 Gillies needle holder - 16 cm



38600 Barraquer Micro needle holder - 13 cm - smooth tips - with lock

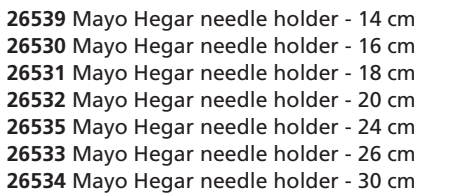

26549 Derf needle holder - 12 cm



38610 Arruga needle holder - straight - 16 cm plain tips  
38611 Arruga needle holder - curved - 16 cm plain tips

### TUNGSTEN CARBIDE FORCEPS - AISI 410

### TC WIRE CUTTERS - AISI 410



26560 Adson - 12 cm  
26561 Adson 1x2 teeth - 12 cm

LONG LASTING JOINT  
GERMAN TIPS



38552 Cushing forceps - 18 cm



26562 Micro Adson forceps - 12 cm - 1x2 teeth  
26563 Micro Adson forceps - 15 cm - 1x2 teeth



38554 Cushing Taylor forceps - 18 cm - rough tips



26570 Wire Cutter - 14 cm - for soft wires 0-1 mm  
26571 Wire Cutter - 18 cm - for hard wires cutting up to 1.6 mm  
26572 Wire Cutter - 23 cm - for hard wires cutting up to 2.0 mm



26558 Gillies Dissecting forceps - 15 cm - 1x2 teeth



38560 Gerald forceps - 17 cm - rough tips



26565 Potts Smith Dissecting forceps - 15 cm  
26566 Potts Smith Dissecting forceps - 18 cm  
26567 Potts Smith Dissecting forceps - 20 cm  
26568 Potts Smith Dissecting forceps - 23 cm  
26569 Potts Smith Dissecting forceps - 25 cm

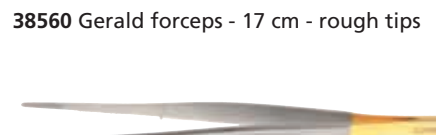

38565 Mc Indoe forceps - 15 cm - rough tips



26575 Wire holding - 18 cm

### TC ORGAN HOLDING FORCEPS - AISI 410



26564 Duval - 20 cm

# TUNGSTEN CARBIDE INSTRUMENTS - GOLD LINE

## TUNGSTEN CARBIDE SCISSORS - AISI 420

**DOUBLE JOINT  
GERMAN TIPS**



- 26500 Straight scissors blunt/sharp - 14.5 cm
- 26501 Straight scissors blunt/blunt - 14.5 cm
- 26502 Straight scissors sharp/sharp - 14.5 cm
- 26503 Curved scissors blunt/sharp - 14.5 cm
- 26504 Curved scissors blunt/blunt - 14.5 cm
- 26505 Curved scissors sharp/sharp - 14.5 cm



- 26510 Metzenbaum scissors - straight - 14 cm
- 26511 Metzenbaum scissors - straight - 18 cm
- 26512 Metzenbaum scissors - straight - 20 cm
- 26514 Metzenbaum scissors - curved - 14 cm
- 26515 Metzenbaum scissors - curved - 18 cm
- 26516 Metzenbaum scissors - curved - 20 cm



- 38510 Mayo Stille scissors - straight - blunt - 15 cm
- 38511 Mayo Stille scissors - curved - blunt - 15 cm
- 38514 Mayo Stille scissors - straight - blunt - 17 cm
- 38515 Mayo Stille scissors - curved - blunt - 17 cm



- 26526 Iris scissors - straight - 11.5 cm
- 26527 Iris scissors - curved - 11.5 cm



- 26520 Mayo scissors - straight - 14.5 cm
- 26521 Mayo scissors - straight - 18 cm
- 26524 Mayo scissors - straight - 23 cm
- 26522 Mayo scissors - curved - 14.5 cm
- 26523 Mayo scissors - curved - 18 cm
- 26525 Mayo scissors - curved - 23 cm



- 38520 Kelly scissors - straight - sharp - 16 cm
- 38521 Kelly scissors - curved - sharp - 16 cm



- 26528 Goldman Fox scissors - straight - 13 cm
- 26529 Goldman Fox scissors - curved - 13 cm



- 38530 Lister scissors - 14 cm
- 38532 Lister scissors - 18 cm



- 26507 Debakey Potts Smith scissors - 19 cm - angle 25°
- 26508 Debakey Potts Smith scissors - 19 cm - angle 45°
- 26509 Debakey Potts Smith scissors - 19 cm - angle 60°
- 26517 Debakey Potts Smith scissors - 23 cm - angle 25°
- 26518 Debakey Potts Smith scissors - 23 cm - angle 45°
- 26519 Debakey Potts Smith scissors - 23 cm - angle 60°



- 26506 Universal scissors - 12 cm

## KEVORKIAN - S/S



26490

Traditional kevorkian bite (9x3 mm)  
Four teeth on bottom jaw  
• 26490 KEVORKIAN  
BIOPSY PUNCH - 20 cm

Textured handle

## MINI-TISCHLER - S/S



26491

Single anchoring tooth on top and bottom jaw  
• 26491 MINI-TISCHLER - straight - extra long - 25 cm

Textured handle

## TISCHLER - S/S



26492

26493

Single anchoring tooth on top and bottom jaw  
• 26492 TISCHLER KEVORKIAN - extra long - 25 cm  
• 26493 TISCHLER - straight - extra long - 25 cm

Textured handle

## SUPER CUT SCISSORS

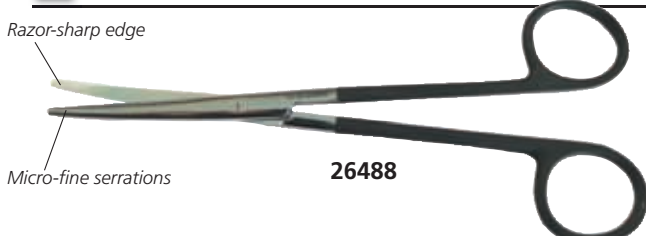

26488



Razor-sharp edge  
Micro-fine serrations

**SUPER CUT SCISSORS**  
Super Cut scissors have a specially designed razor-sharp upper blade edge that cuts effortlessly through tissue. The lower blade has micro-fine serrations to hold tissue and prevent slippage.





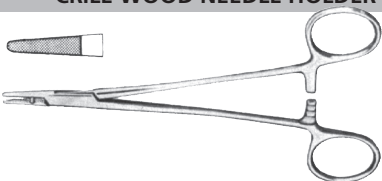
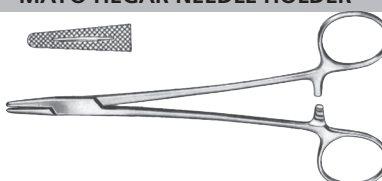

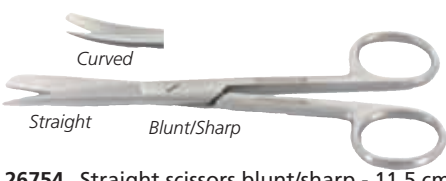

Tungsten carbide honed insert combined with razor-sharp edge  
Tungsten carbide insert with micro-fine serrations

- 26488 METZENBAUM SCISSORS SUPER CUT - curved - 15 cm
- 26489 METZENBAUM SCISSORS SUPER CUT - curved - 18 cm
- 26485 MAYO SCISSORS SUPER CUT WITH T.C. - curved - 14 cm
- 26486 MAYO SCISSORS SUPER CUT WITH T.C. - curved - 17 cm
- 26487 MAYO SCISSORS SUPER CUT WITH T.C. - curved - 20 cm

## STAINLESS STEEL NEEDLE HOLDERS

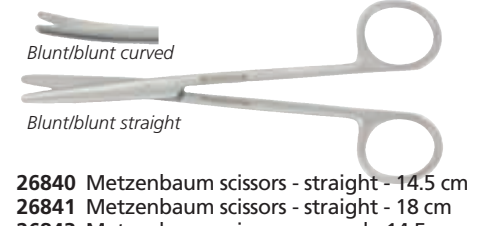
CRILE WOOD NEEDLE HOLDER	MAYO HEGAR NEEDLE HOLDER	MATHIEU NEEDLE HOLDER
		
<p>26852 Crile Wood needle holder - 15 cm</p> <p>26878 Crile Wood needle holder - 18 cm</p> <p>26879 Crile Wood needle holder - 20 cm</p>	<p>26818 Mayo Hegar needle holder - 14 cm</p> <p>26732 Mayo Hegar needle holder - 16 cm</p> <p>26819 Mayo Hegar needle holder - 18 cm</p> <p>26733 Mayo Hegar needle holder - 20 cm</p>	<p>26741 Mathieu needle holder - 14 cm</p> <p>26730 Mathieu needle holder - 16 cm</p> <p>26731 Mathieu needle holder - 20 cm</p>

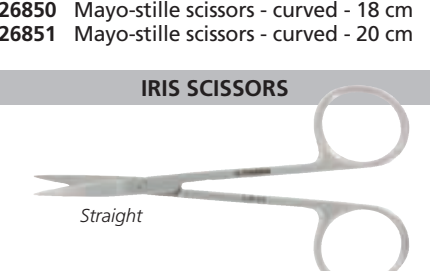
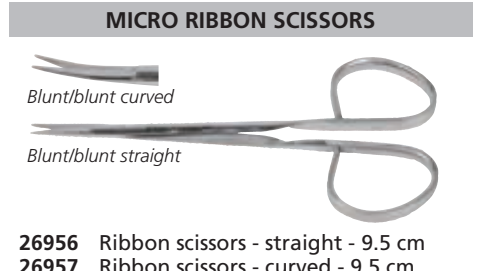
## STAINLESS STEEL SURGICAL SCISSORS

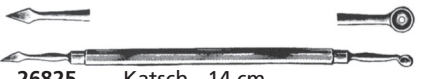
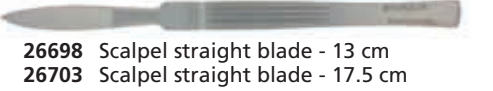
BLUNT/SHARP SCISSORS	BLUNT/BLUNT SCISSORS	SHARP/SHARP SCISSORS
		
<p>26754 Straight scissors blunt/sharp - 11.5 cm</p> <p>26725 Straight scissors blunt/sharp - 14.5 cm</p> <p>26729 Straight scissors blunt/sharp - 16 cm</p> <p>26853 Straight scissors blunt/sharp - 18 cm</p> <p>26726 Straight scissors blunt/sharp - 20 cm</p> <p>26755 Curved scissors blunt/sharp - 11.5 cm</p> <p>26727 Curved scissors blunt/sharp - 14.5 cm</p> <p>26756 Curved scissors blunt/sharp - 16 cm</p> <p>26854 Curved scissors blunt/sharp - 18 cm</p> <p>26728 Curved scissors blunt/sharp - 20 cm</p>	<p>26855 Straight scissors blunt/blunt - 11.5 cm</p> <p>26740 Straight scissors blunt/blunt - 14.5 cm</p> <p>26856 Straight scissors blunt/blunt - 16 cm</p> <p>26857 Straight scissors blunt/blunt - 18 cm</p> <p>26887 Straight scissors blunt/blunt - 20 cm</p> <p>26888 Curved scissors blunt/blunt - 11.5 cm</p> <p>26742 Curved scissors blunt/blunt - 14.5 cm</p> <p>26889 Curved scissors blunt/blunt - 16 cm</p> <p>26890 Curved scissors blunt/blunt - 18 cm</p> <p>26891 Curved scissors blunt/blunt - 20 cm</p>	<p>26892 Straight scissors sharp/sharp - 11.5 cm</p> <p>26744 Straight scissors sharp/sharp - 14.5 cm</p> <p>26893 Straight scissors sharp/sharp - 16 cm</p> <p>26894 Straight scissors sharp/sharp - 18 cm</p> <p>26895 Straight scissors sharp/sharp - 20 cm</p> <p>26896 Curved scissors sharp/sharp - 11.5 cm</p> <p>26746 Curved scissors sharp/sharp - 14.5 cm</p> <p>26897 Curved scissors sharp/sharp - 16 cm</p> <p>26898 Curved scissors sharp/sharp - 18 cm</p> <p>26899 Curved scissors sharp/sharp - 20 cm</p>
LISTER BANDAGE SCISSORS	MAYO-STILLE SURGICAL SCISSORS	METZENBAUM SURGICAL SCISSORS
		
<p>34125 Lister scissors - 11 cm</p> <p>34129 Lister scissors - 16 cm</p> <p>34130 Lister scissors - 18 cm</p>	<p>26846 Mayo-stille scissors - straight - 14.5 cm</p> <p>26847 Mayo-stille scissors - straight - 18 cm</p> <p>26848 Mayo-stille scissors - straight - 20 cm</p> <p>26849 Mayo-stille scissors - curved - 14.5 cm</p> <p>26850 Mayo-stille scissors - curved - 18 cm</p> <p>26851 Mayo-stille scissors - curved - 20 cm</p>	<p>26840 Metzenbaum scissors - straight - 14.5 cm</p> <p>26841 Metzenbaum scissors - straight - 18 cm</p> <p>26843 Metzenbaum scissors - curved - 14.5 cm</p> <p>26844 Metzenbaum scissors - curved - 18 cm</p>
STITCH REMOVER FORCEPS/SCISSORS	IRIS SCISSORS	MICRO RIBBON SCISSORS
		
<p>26737 Spencer scissors - 13 cm for suture</p> <p>26722 Michel stitch remover forceps - 12 cm</p> <p>26900 Heaths ligature scissors - 15 cm</p>	<p>26822 Iris scissors - straight - 11.5 cm</p> <p>26824 Iris scissors - curved - 11.5 cm</p>	<p>26956 Ribbon scissors - straight - 9.5 cm</p> <p>26957 Ribbon scissors - curved - 9.5 cm</p> <p>26958 Ribbon scissors - straight - 12 cm</p> <p>26959 Ribbon scissors - curved - 12 cm</p>
DELIVERY SCISSORS	DERMATOLOGY PROBES	PROBES, SCALPELS
		
<p>26827 Umbilical scissors Usa model - 10.5 cm</p> <p>26874 Brown Sadler episiotomy scissors - 14 cm</p>	<p>26825 Katsch - 14 cm</p> <p>26826 Gillies hook - 13 cm - small</p> <p>26821 Unna round - 14 cm</p> <p>26820 Unna Oval - 14 cm</p> <p>26823 Round forceps - 9 cm</p>	<p>26698 Scalpel straight blade - 13 cm</p> <p>26703 Scalpel straight blade - 17.5 cm</p> <p>26699 Scalpel pot-bellied blade - 13 cm</p> <p>26704 Scalpel pot-bellied blade - 17.5 cm</p> <p>26701 Probe D-end - 15 cm - Ø 2 mm</p> <p>26702 Butterfly probe - 14.5 cm</p>



# STAINLESS STEEL SURGICAL FORCEPS

TOWEL FORCEPS	HAEMOSTATIC FORCEPS	DRESSING SPONGE HOLDING FORCEPS
---------------	---------------------	---------------------------------





**26743** Backhaus forceps - 9 cm  
**26736** Backhaus forceps - 11 cm  
**26747** Backhaus forceps - 13.5 cm  
  
**26739** Backhaus Forceps for TNT - 13 cm

### DISSECTING FORCEPS



**26690** Anatomy forceps - 12 cm  
**26705** Anatomy forceps - 14 cm  
**26691** Anatomy forceps - 16 cm  
**26706** Anatomy forceps - 18 cm  
**26752** Anatomy forceps - 20 cm  

**26692** Surgery forceps - 12 cm - 1x2 teeth  
**26707** Surgery forceps - 14 cm - 1x2 teeth  
**26693** Surgery forceps - 16 cm - 1x2 teeth  
**26708** Surgery forceps - 18 cm - 1x2 teeth  
**26753** Surgery forceps - 20 cm - 1x2 teeth  

**26750** Adson forceps - 12 cm  
**26751** Adson forceps - 12 cm - 1x2 teeth  
**26694** Micro Adson forceps - 12 cm  
**26695** Micro Adson forceps - 12 cm - 1x2 teeth  



**26724** Forceps thin end - 12 cm  

**26977** English Toe plain dissecting forceps - 14 cm



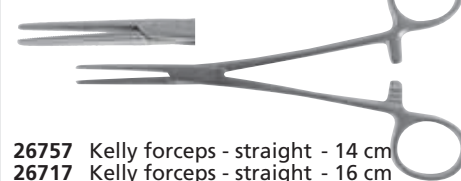

**26714** Mosquito forceps - straight - 12.5 cm  
**26872** Mosquito forceps - straight - 14 cm  
**26715** Mosquito forceps - straight - 16 cm  
**26716** Mosquito forceps - curved - 12.5 cm  
**26873** Mosquito forceps - curved - 14 cm



**26757** Kelly forceps - straight - 14 cm  
**26717** Kelly forceps - straight - 16 cm  
**26758** Kelly forceps - curved - 14 cm  
**26718** Kelly forceps - curved - 16 cm  

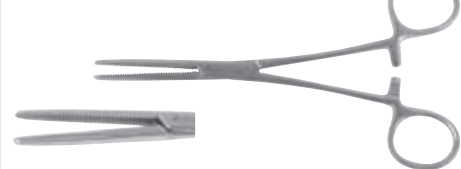

*Straight*  
*Curved*  
**26828** Kocher forceps - straight - 14 cm - 1x2  
**26711** Kocher forceps - straight - 16 cm - 1x2  
**26829** Kocher forceps - straight - 18 cm - 1x2  
**26712** Kocher forceps - straight - 20 cm - 1x2  
**26831** Kocher forceps - curved - 14 cm - 1x2  
**26832** Kocher forceps - curved - 16 cm - 1x2  
**26833** Kocher forceps - curved - 18 cm - 1x2  
**26834** Kocher forceps - curved - 20 cm - 1x2



**26749** Klemmer forceps - straight - 14 cm  
**26709** Klemmer forceps - straight - 16 cm  
**26835** Klemmer forceps - straight - 18 cm  
**26713** Klemmer forceps - straight - 20 cm  
**26836** Klemmer forceps - curved - 14 cm  
**26837** Klemmer forceps - curved - 16 cm  
**26838** Klemmer forceps - curved - 18 cm  
**26839** Klemmer forceps - curved - 20 cm  

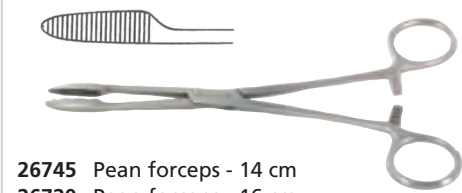

**26978** Mixer forceps - 23 cm



**26745** Pean forceps - 14 cm  
**26720** Pean forceps - 16 cm  
**26710** Pean forceps - 20 cm  

*Serrated rings*  
**26800** Foerster forceps - 20 cm  
**26801** Foerster forceps - 25 cm





**26805** Foerster "small ring" forceps - 25 cm  

**26845** Duval 14 cm x 10 mm



*Curved*     *Straight*  
**26845** Duval 14 cm x 10 mm  
**26734** Crile forceps - straight - 16 cm  
**26735** Crile forceps - curved - 16 cm



**26721** Allis forceps - 15 cm - 4x5 teeth  
**26759** Allis forceps - 19 cm - 5x6 teeth  

**26986** Cheron forceps - 25 cm

### ANESTHESIA FORCEPS



**34005** Collin Forceps - 20 cm  

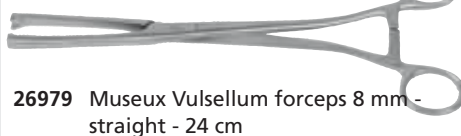

**34001** Magill Forceps - 15 cm - infants  
**34002** Magill Forceps - 20 cm - children  
**34003** Magill Forceps - 25 cm - adults

### OB/GYN FORCEPS



**26979** Museux Vulsellum forceps 8 mm - straight - 24 cm

### BONE CUTTING FORCEPS



**26983** Luer forceps - 15 cm - sharp edge  

**26984** Ruskin Liston forceps - 18 cm

### DRESSING SWAB FORCEPS

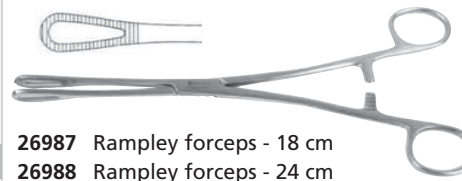

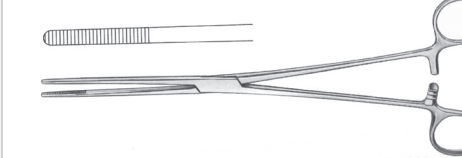
**26987** Rampley forceps - 18 cm  
**26988** Rampley forceps - 24 cm  

**26811** Bozeman dressing forceps straight - 26 cm  
**26812** Bozeman dressing forceps curved - 26 cm

## S/S INSTRUMENT KITS



GIMA code	INSTRUMENTS KIT IN ALUMINIUM BOX OR POLYESTER BAG	26701	26702	26703	26704	26705	26707	26709	26722	26723	26724	26725	26730	26732
26760	Trousse standard - polyester bag 9 instr.	•	•	•	•	•	•	•	•	•	•	•	•	•
26761	Trousse classica - polyester bag 10 instr.	•	•	•	•	•	•	•	•	•	•	•	•	•
26762	Trousse suprema - polyester bag 11 instr.	•	•	•	•	•	•	•	•	•	•	•	•	•
26768	Trousse suprema - aluminium box 11 instr.	•	•	•	•	•	•	•	•	•	•	•	•	•

## S/S DRESSING, SUTURE AND DELIVERY SURGERY SETS



• 26963 DRESSING SET - 8 PIECES



• 26965 SUTURE SET - 12 PIECES

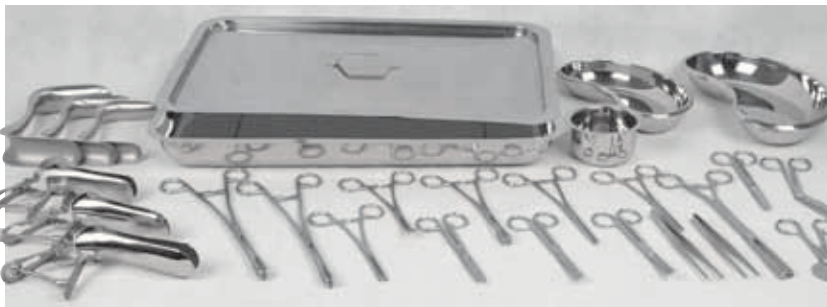

• 26966 MINOR DELIVERY SET - 25 PIECES

SET CONTENTS	26963	26965	26966
Kidney Dish 20 cm (8") - medium	•	•	•
Kidney Dish 25 cm (10") - large	•	•	•
Gallipot 150 ml - 6 oz - medium	•	•	•
Mayo Hegar needle holder - 18 cm	•	•	•
Brown Sadler episiotomy scissors - 14 cm	•	•	•
Kocher artery forceps - straight - 16 cm	•	•	•
Kocher artery forceps straight - 18 cm	•	•	•
Kocher artery forceps curved - 16 cm	•	•	•
Dressing Forceps (Thumb) - 16 cm	•	•	•
English TOE dissecting forceps - plain - 14 cm	•	•	•
English TOE dissecting forceps - plain - 18 cm	•	•	•
Dissecting forceps toothed 1x2 - 14 cm	•	•	•
Suture scissors - Heaths Ligature - 15 cm	•	•	•
Mayo scissors - straight - 15 cm	•	•	•
Operating scissors sharp/blunt - straight - 15 cm	•	•	• 2 pcs.
Operating scissors sharp/blunt - curved - 15 cm	•	•	• 2 pcs.
Ramplay sponge holding forceps - str. - 18 cm	•	•	•
Ramplay sponge holding forceps - str. - 24 cm	•	•	• 2 pcs.
Museux Vulsellum forceps 8 mm - str. - 24 cm	•	•	•
Cusco vaginal specula - small	•	•	•
Cusco vaginal specula - medium	•	•	•
Cusco vaginal specula - large	•	•	•
Sims vaginal specula - small	•	•	•
Sims vaginal specula - medium	•	•	•
Sims vaginal specula - large	•	•	•
Umbilical scissors USA Patent - 10.5 cm	•	•	•
Instrument tray with lid 25x30x6.2 cm	•	•	•
Instrument tray with lid 30x20x5 cm	•	•	•
Instrument tray with lid 45x30x6.2 cm	•	•	•

## GYNAECOLOGY INSTRUMENTS AND KIT



26807 Novak suction cannula - 23 cm - Ø 4 mm

26804 ★ Sims hystrometer - malleable - 33 cm - silver

26816 Martin hystrometer - 30 cm - malleable - brass handle, copper wire

26803 ★ Bosch/Sims scissors - 23 cm

26802 ★ Schroeder forceps - 25 cm (Pozzi-Palmer)

26801 ★ Foerster forceps - 25 cm

• 26810 GYNAECOLOGY KIT Includes 4 instruments marked with ★ in a nylon bag.



26817

26817 Set of chrome plated Hegar Dilators Include 14 dilators Ø 4-17 mm



• 26884 SET OF 3 SIMS RETRACTORS



26810



Rigid cannula with sharp tip

26813 Sims uterine curette - sharp - 8 mm - 26 cm  
26814 Sims uterine curette - sharp - 9 mm - 26 cm  
26815 Sims uterine curette - sharp - 14 mm - 26 cm

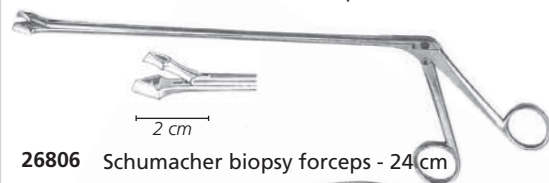

26806 Schumacher biopsy forceps - 24 cm

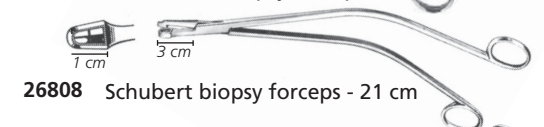

26808 Schubert biopsy forceps - 21 cm

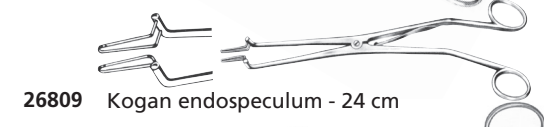

26809 Kogan endospeculum - 24 cm

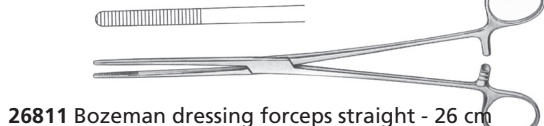

26811 Bozeman dressing forceps straight - 26 cm  
26812 Bozeman dressing forceps curved - 26 cm

# ENT STAINLESS STEEL INSTRUMENTS AND KIT



**Tongue depressors**  
 25620 Mayo tongue depressor - 17 cm  
 25621 Bruenings tongue depr - fenestrated - 19 cm ●  
 25623 Tobold tongue depressor



**Nose/ear speculum**  
 26774 Voltolini nose speculum - adjustable - Size 2 ●  
 26775 Voltolini nose speculum - adjustable - Size 0  
 26770 Set of 3 ear speculum Hartmann - Ø 4, 5, 6 mm ●  
 26784 Thudicum nose clip



**Nose Ear forceps and scissors**  
 26773 Lucae ear forceps - 14 cm ●  
 26783 Troeltsch ear forceps - 12 cm  
 26779 Hartmann ear forceps - 14 cm  
 26781 Heymann scissors - 18 cm



**Suction cannulas**  
 26795 Frazier nose/ear suction cannula Ø 2 mm (18 cm)  
 26796 Frazier nose/ear suction cannula Ø 3 mm (18 cm)  
 26793 Frazier nose suction cannula Ø 4 mm (18 cm)  
 26794 Frazier nose suction cannula Ø 5 mm (18 cm)  
 26797\* Rosen ear suction cannula Ø 1.5 mm (15.5 cm)  
 26798\* Rosen ear suction cannula Ø 3 mm (16.1 cm)  
 \*with adaptor with LUER tip and thumb valve

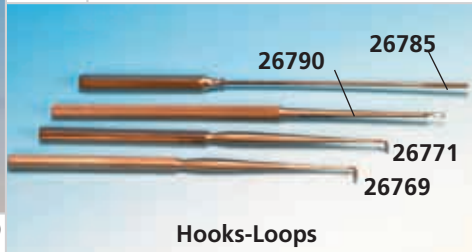

**Hooks-Loops**  
 26771 Lucae Hook - 14 cm (5'4") ●  
 26769 Lucae Hook - fine - 14 cm (5'4")  
 26790 Billeau Loop - 16 cm  
 26785 Swab holder - 16 cm



**Killian/Hartmann nose forceps**  
 26792 Killian/Hartmann nose forceps - 14 cm (5'4")/15 mm  
 26778 Killian/Hartmann nose forceps - 14 cm (5'4")/22 mm  
 26772 Killian/Hartmann nose forceps - 14 cm (5'4")/35mm ●  
 26776 Killian/Hartmann nose forceps - 14 cm (5'4")/50mm  
 26764 Killian/Hartmann nose forceps - 15 cm (5'9")/75mm  
 26777 F. O. Killian nose forceps - 14 cm/75mm fiber optic  
 26765 Tieck Halle nose speculum - 13.5 cm

GIMA code	Hartmann ear forceps			Picture
	mm			
	A	B	C	
26782	90	11	0.6	Serrated tip
Hartmann micro forceps				
26786	80	6	0.3	C
26787	80	4	0.6	B

● **26788 MICRO EAR CUP-SHAPED POLYPUS FORCEPS**  
 A = 80 mm, B = 4 mm

● **26789 MICRO EAR SCISSORS BELLUCCI**  
 A = 80 mm, B = 4 mm  
 C = 0,8 mm tip thickness

● **26791 MICRO EAR PUNCH - introduction instrument**  
 A = 80 mm, B = 4 mm  
 1.3 mm



● **26780 ENT KIT** Includes all instruments marked with ● inside an aluminium box (Code 26665) 21x10xh 5 cm.

# LARYNGEAL MIRRORS AND SPIRIT LAMP



31614

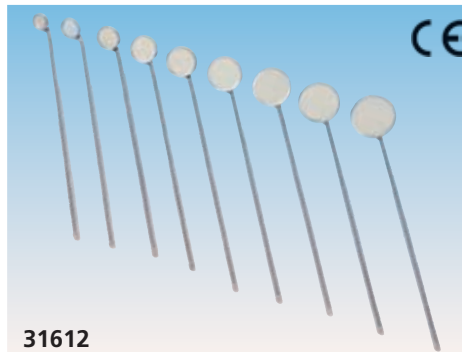

31612

● **31616 ADJUSTABLE MIRROR HANDLE - 12.5 cm**  
 ● **31615 ADJUSTABLE MIRROR HANDLE - 8 cm**  
 31615+31606  
 31616+31605

GIMA code	LARYNGEAL MIRROR - STRAIGHT - 13 cm	Minimum order
31600	Mirror number 000 diameter 10 mm	10 pcs. mixed sizes
31601	Mirror number 00 diameter 12 mm	
31602	Mirror number 0 diameter 14 mm	
31603	Mirror number 1 diameter 16 mm	
31604	Mirror number 2 diameter 18 mm	
31605	Mirror number 3 diameter 20 mm	
31606	Mirror number 4 diameter 22 mm	
31607	Mirror number 5 diameter 24 mm	
31608	Mirror number 6 diameter 26 mm	

● **31612 SET 9 LARYNGEAL MIRRORS 000-6**  
 Set of 9 laryngeal mirrors from 000 to 6, all mirrors have a different diameter: from 10 mm to 26 mm.  
 Instructions: GB, FR, IT, ES, PT.

minimum order: 1 set of 9 mirrors

● **31614 SPIRIT LAMP - 100 ml**  
 Lamp is made of AISI 304 stainless steel.  
 Brass cap to close flame area to avoid discoloration.

## GOUGE BLADES AND HANDLES

### CARBON STEEL GOUGE BLADES - sterile

Sterile, sharp, surgical gouge blades are used by podologists for hand, feet and skin care. Each blade is sterilized by gamma

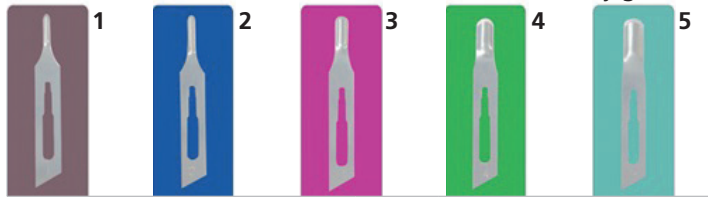

CARBON STEEL GOUGE BLADES - STERILE			
GIMA code		code	
22501	Blades 1 - box of 50	22506	Blades 6 - box of 50
22502	Blades 2 - box of 50	22508	Blades 8 - box of 50
22503	Blades 3 - box of 50	22510	Blades 10 - box of 50
22504	Blades 4 - box of 50	22512	Blades 12 - box of 50
22505	Blades 5 - box of 50	22515	Blades 15 - box of 50

radiation and protected by VCI paper in a peel - open foil sachet. Gouge blades fit into handle no. 3 and special gouge handle. Wide range of sizes.

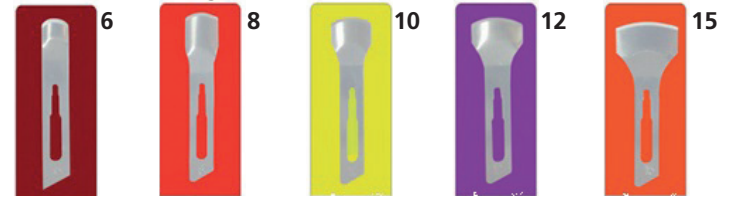

STAINLESS STEEL HANDLES	
GIMA code	
22520	Special gouge handle - stainless steel
26913	Gouge/scalpel handle N°3 - stainless steel - see page 61

\*Compatible with blades from 10 to 15

## PODIATRY-CHIROPODY STAINLESS STEEL INSTRUMENTS

### SCISSORS

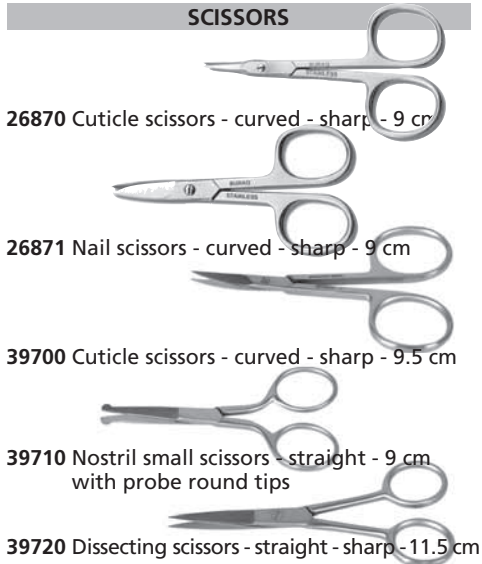

### TWEEZERS

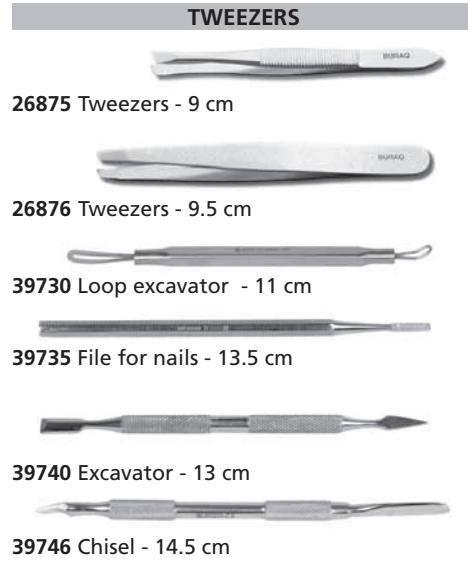

### PEDICURE FILES



### CUTTERS/NIPPERS

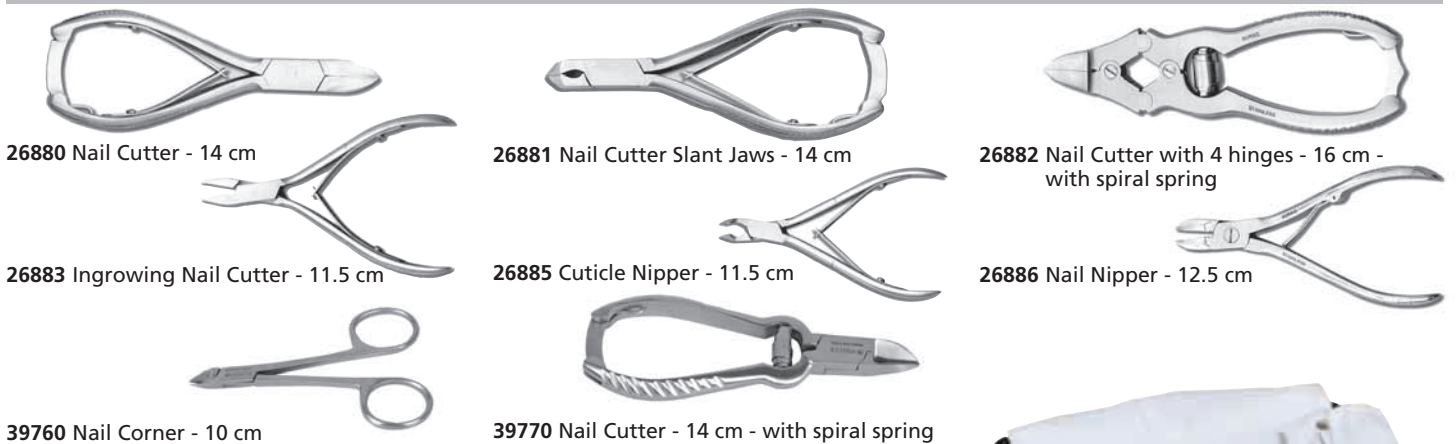

## PODIATRY STAINLESS STEEL KITS



• **39800 HEART SHAPE KIT - blue**  
Cuticle nipper 10 cm, Nail nipper 10 cm, Nail scissors 9.5 cm, Nail file 10 cm, Pusher double ended 12 cm, Tweezers 10 cm



• **39805 STEEL FRAME KIT**  
Nail nipper 10 cm, Nail Scissor 9.5 cm, Cuticle scissors 9.5 cm, Cuticle pusher double ended 12 cm. Cuticle pusher and cleaner 13 cm, Tweezers 9 cm, Nail file with white plastic handle 9 cm



• **39810 PROFESSIONAL KIT**  
Nail nipper Moon Shape 14 cm, Side cutter 13 cm, Cuticle Nipper 10 cm, Dressing Scissors 14 cm, B.P. handle No. 4 13.5 cm, Splinter Tweezers 12 cm, Loop 14 cm, Knife & Cleaner double ended 16 cm, Nail file 12 cm, Nail file with white plastic handle 13 cm, Spatula double ended 15 cm

# DENTAL STAINLESS STEEL INSTRUMENTS

## EXTRACTING-FORCEPS - FOR JAWS



**60040**  
set of 10 perforated  
impression trays  
(5 lower + 5 upper)



**60045**  
set of 10 solid impression  
trays (5 lower + 5 upper)  
Above impression trays sets  
have below sizes

UPPER SIZES mm	
	U1 U2 U3 U4 U5
A	62 60 53 54 52
B	83 75 73 69 68

LOWER SIZES mm	
	L1 L2 L3 L4 L5
A	63 61 57 60 53
B	82 81 78 74 71



fig. 1 **60000** upper 17.5 cm  
 fig. 2 **60001** upper 17.5 cm  
 fig. 7 **60002** upper 17.5 cm  
 fig. 17 **60003** upper 17.5 cm  
 fig. 18 **60004** upper 17.5 cm  
 fig. 29 **60005** upper 17.5 cm

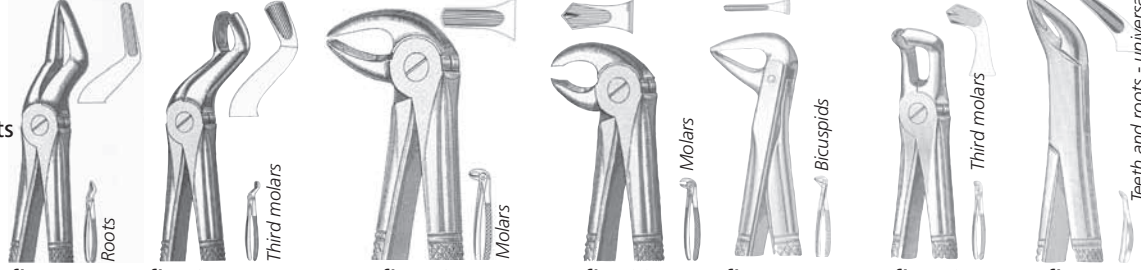
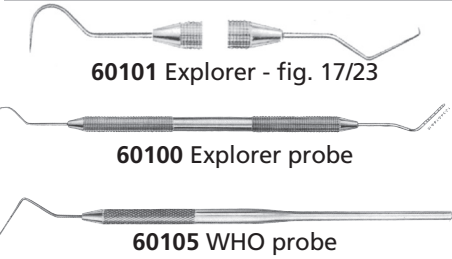

fig. 51 **60006** upper 18.5 cm  
 fig. 67A **60007** upper 18.5 cm  
 fig. 16 **60015** lower 18.5 cm  
 fig. 22 **60016** lower 15 cm  
 fig. 74N **60017** lower 15.1 cm  
 fig. 79 **60018** lower 17.5 cm  
 fig. 151 **60019** lower 17 cm

### EXPLORER AND PROBES



**60101** Explorer - fig. 17/23

**60100** Explorer probe

**60105** WHO probe

### SCALER

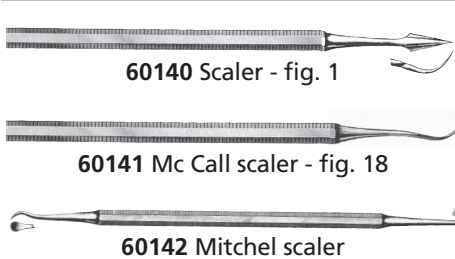

**60140** Scaler - fig. 1

**60141** Mc Call scaler - fig. 18

**60142** Mitchel scaler

### CARVER

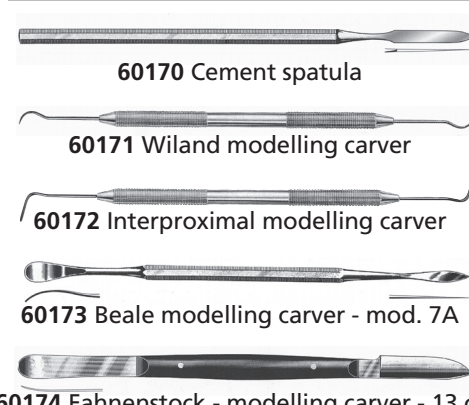

**60170** Cement spatula

**60171** Wiland modelling carver

**60172** Interproximal modelling carver

**60173** Beale modelling carver - mod. 7A

**60174** Fahrenstock - modelling carver - 13 cm

### GRACEY AND Mc CALL CURETTES

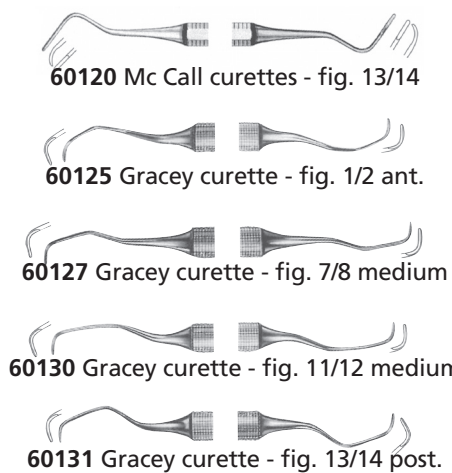

**60120** Mc Call curettes - fig. 13/14

**60125** Gracey curette - fig. 1/2 ant.

**60127** Gracey curette - fig. 7/8 medium

**60130** Gracey curette - fig. 11/12 medium

**60131** Gracey curette - fig. 13/14 post.

**60144** Langer scaler - fig. 1/2

**60145** Langer scaler - fig. 3/4

**60148** Hygienist scaler - fig. H6/7

**60150** Scaler - fig. 2045

**60155** Periodontia instr. - fig. ST 2/3

**60156** Periodontia instr.

### FORCEPS



**60190** London college forceps - 15 cm

### CARTRIDGE SYRINGE

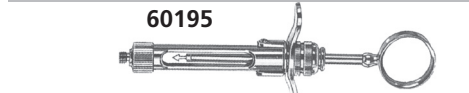

**60195**

**60195** Cartridge Syringe - 2.2 cc  
with thread in millimeter  
with aspiration

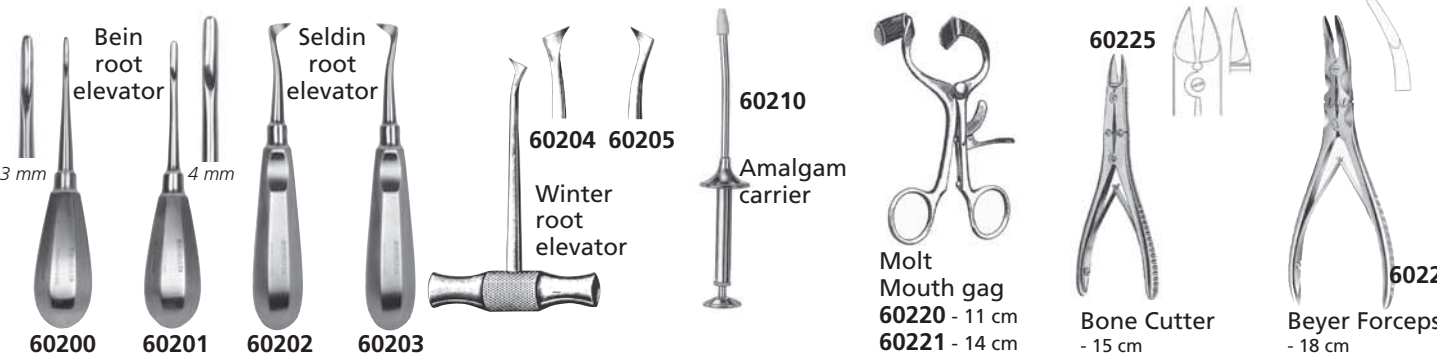

Bein  
root  
elevator

Seldin  
root  
elevator

**60204** **60205**

Winter  
root  
elevator

**60210**

Amalgam  
carrier

Molt  
Mouth gag

**60220** - 11 cm  
**60221** - 14 cm

**60225**

Bone Cutter  
- 15 cm

**60226**

Beyer Forceps  
- 18 cm

# PEHA® DISPOSABLE STAINLESS STEEL INSTRUMENTS - STERILE

Single-use instruments made of matt brushed, high-quality stainless steel. Made in EU, they offer similar characteristics as multi-use instruments in terms of intended performance, haptics and design. Sterile, individually packed and ready-to-use for a variety of surgical interventions. They allow precise handling during procedures. Peha® color lock® safety marking allows quick and reliable differentiation from multi-use instruments. The self-adhesive traceability label on the packaging facilitates easy, fast and less error prone data entry into the patient records. Excellent choice for health care facilities with no processing unit. Recyclable and disposable in existing clinical waste containers after use. Multilingual box: GB, FR, IT, ES, PT, DE, NL, PL, GR, HU, CZ, SI, RU, Arabic.



## STERILE SCISSORS



38701

- **38700** Operating scissors sharp/sharp straight - 13 cm - 991083 - box of 25
- **38701** Operating scissors sharp/blunt straight - 14.5 cm - 991081 - box of 25
- **38702** Operating scissors blunt/blunt straight - 14.5 cm - 991082 - box of 25



- **38712** Braun-Stadler episiotomy scissors 14.5 cm - 991080 - box of 20



38708

- **38705** Metzenbaum scissors blunt/blunt curved - 14.5 cm - 991084 - box of 25
- **38708** Iris scissors straight - 11.5 cm - 991086 - box of 25
- **38709** Iris scissors curved - 11.5 cm - 991087 - box of 25

## STERILE NEEDLE HOLDER



38720

- **38720** Mayo-Hegar needle holder 12 cm - 991031 - box of 25
- **38721** Mayo-Hegar needle holder 14 cm - 991030 - box of 25
- **38722** Mayo-Hegar needle holder 16 cm - 991034 - box of 25

## STERILE CURETTE



- **38726** Curette sharp spoon double end - 16.5 cm - 991010 - box of 25

## STERILE FORCEPS



- **38746** Standard tissue forceps straight - 14 cm - 991063 - box of 25



- **38748** Standard anatomic forceps straight - 14 cm - 991064 - box of 25



- **38744** Adson tissue forceps straight - 12 cm - 991062 - box of 25



- **38740** Adson anatomic forceps straight - 12 cm - 991060 - box of 25

## STERILE HAEMOSTATIC FORCEPS

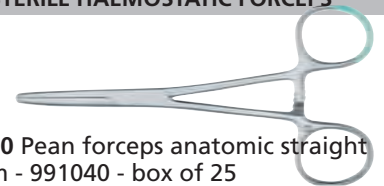

- **38730** Pean forceps anatomic straight - 14 cm - 991040 - box of 25



- **38738** Micro-Mosquito forceps anatomic straight - 12.5 cm - 991044 - box of 25

## STERILE HAEMOSTATIC FORCEPS



- **38742** DeBakey forceps straight - 15.5 cm - 991061 - box of 25



- **38733** Halsted Mosquito forceps anatomic curved - 12.5 cm - 991041 - box of 25



- **38735** Kocher tissue forceps straight - 14 cm - 991042 - box of 25

# STAINLESS STEEL RETRACTORS

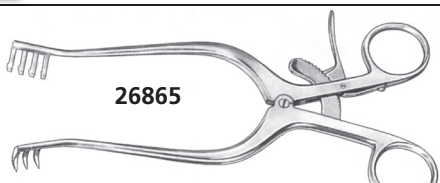

26865

- **26858** Weitlaner-Loktite retractor - sharp 13 cm - 3x4 prongs
- **26859** Weitlaner-Loktite retractor - blunt 13 cm - 3x4 prongs
- **26865** Weitlaner Retractor - sharp 20 cm - 3x4 prongs
- **26866** Weitlaner Retractor - blunt 20 cm - 3x4 prongs

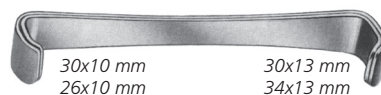

- **26867** Farabeuf retractors - set of 2 - 12 cm

- **26868** Frazier Hook - sharp - 13 cm
- **26869** Frazier Hook - blunt - 13 cm



- **26723** Hook - 15 cm



- **26860** Masing Retractor - 14 cm



- **26989** Senn-Muller - 15.5 cm

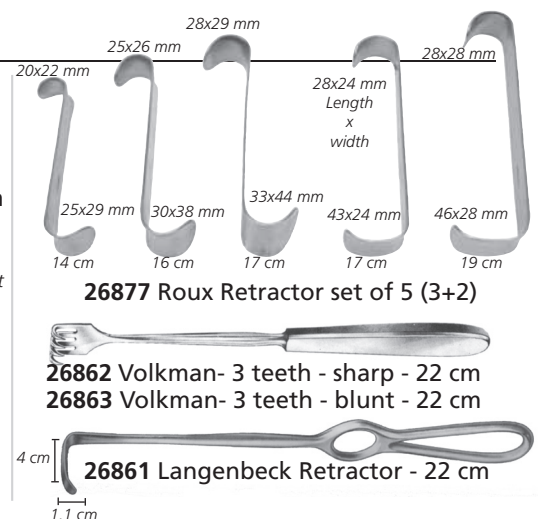

- **26877** Roux Retractor set of 5 (3+2)

- **26862** Volkman- 3 teeth - sharp - 22 cm
- **26863** Volkman- 3 teeth - blunt - 22 cm



- **26861** Langenbeck Retractor - 22 cm

# DISPOSABLE STAINLESS STEEL INSTRUMENTS - STERILE

A complete range of disposable instruments made of sturdy stainless steel alternative to plastic disposable instruments. Each instrument has a blue coloured part to avoid mix with reusable instruments and is individually packed in a sterile pouch.

Sterilized by Gamma radiation.  
Sold in box of 10 or 25 pouches.  
Instructions: GB, FR, IT, ES, DE, PT, PL, NL, SE, HU, GR, Arabic.

**BLUE HANDLES**  
means disposable  
for instant identification



## STERILE SCISSORS - STAINLESS STEEL

- **38800** Surgical scissors sharp/sharp - straight - 13 cm - box of 25
- **38801** Surgical scissors sharp/blunt - straight - 13 cm - box of 25
- **38809** Metzenbaum scissors - straight - 16 cm - box of 25
- **38810** Metzenbaum scissors - curved - 16 cm - box of 25
- **38812** Metzenbaum scissors - curved - 18 cm - box of 25
- **38830** Iris scissors sharp/sharp - straight - 11.5 cm - box of 25
- **38831** Iris scissors sharp/sharp - curved - 11.5 cm - box of 25
- **38820** Mayo scissors - straight - 15 cm - box of 25
- **38822** Mayo scissors - straight - 17 cm - box of 25
- **38840** Lister bandage scissors - 14 cm
- **38841** Lister bandage scissors - 16 cm
- **38842** Lister bandage scissors - 18 cm - box of 25
- **38835** Umbilical scissors - straight - 10.5 cm - US model - box of 25

## STERILE FORCEPS - STAINLESS STEEL

- **38850** Dressing tissue forceps - straight - 13 cm - box of 25
- **38852** Dressing tissue forceps - straight - 16 cm - box of 25
- **38851** Dressing forceps - straight - 13 cm 1x2 teeth - box of 25
- **38860** Pean forceps - curved - 14 cm
- **38861** Pean forceps - curved - 16 cm
- **38862** Pean forceps - curved - 18 cm - box of 25
- **38885** Splinter plain forceps - 12.5 cm - box of 25
- **38865** Spencer Wells forceps - straight - 13 cm - box of 25
- **38875** Haemostatic Halstead-Mosquito artery forceps - straight - 12.5 cm - box of 25
- **38876** Haemostatic Halstead-Mosquito artery forceps - curved - 12.5 cm - box of 25
- **38887** Foerster polypus forceps - 25 cm - box of 10
- **38870** Adson tissue forceps - straight - 12 cm - box of 25
- **38871** Adson tissue forceps - straight - 12 cm 1x2 teeth - box of 25
- **38880** McIndoe dissecting forceps - straight - 15 cm - box of 25
- **38890** Magill forceps - 20 cm for children - box of 10
- **38891** Magill forceps - 25 cm for adult - box of 10

## STERILE NEEDLE HOLDERS - STAINLESS STEEL

- **38895** Micro Hartmann ear forceps - 15 cm - 3 mm - box of 10
- **38897** Micro Bellucci ear scissors - 15 cm - 3 mm - box of 10
- **38920** Mayo-Hegar needle holder - 14 cm - box of 25
- **38921** Mayo-Hegar needle holder - 16 cm - box of 25
- **38930** Crile Wood needle holder - 15 cm - box of 25

## DISPOSABLE STAINLESS STEEL PROCEDURE PACKS - STERILE

- **38950 SUTURE REMOVAL PACK - box of 25**  
Pack includes: Iris scissors - straight - 11.5 cm  
Adson tissue forceps - toothed - 12 cm
- **38951 SUTURE PROCEDURE PACK - box of 25**  
Pack includes: Spencer ligature scissors - straight - 9 cm  
Adson tissue forceps - toothed - 12 cm

## FOLEY CATHETERS - LATEX

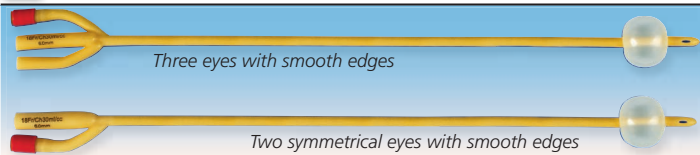

GIMA code	LATEX STERILE 100% SILICONE COATED FOLEY CATHETERS - SINGLE USE	Minimum order
<b>Two-way catheters - balloon 5-10 ml - length 40 cm - soft valve</b>		
22054	2-way Foley catheter ch/fr 12 - balloon 5-10 ml	box of 10
22055	2-way Foley catheter ch/fr 14 - balloon 5-10 ml	box of 10
22056	2-way Foley catheter ch/fr 16 - balloon 5-10 ml	box of 10
22057	2-way Foley catheter ch/fr 18 - balloon 5-10 ml	box of 10
22058	2-way Foley catheter ch/fr 20 - balloon 5-10 ml	box of 10
22059	2-way Foley catheter ch/fr 22 - balloon 5-10 ml	box of 10

Ball 5-10 ml means that the ball could be from 5 ml to 10 ml

GIMA code	LATEX STERILE 100% SILICONE COATED FOLEY CATHETERS - SINGLE USE	Minimum order
<b>Two-way catheters - balloon 30 ml - length 40 cm - soft valve</b>		
22064	2-way Foley catheter ch/fr 12 - balloon 30 ml	box of 50
22065	2-way Foley catheter ch/fr 14 - balloon 30 ml	box of 50
22066	2-way Foley catheter ch/fr 16 - balloon 30 ml	box of 50
22067	2-way Foley catheter ch/fr 18 - balloon 30 ml	box of 50
22068	2-way Foley catheter ch/fr 20 - balloon 30 ml	box of 50
22069	2-way Foley catheter ch/fr 22 - balloon 30 ml	box of 50
22070	2-way Foley catheter ch/fr 24 - balloon 30 ml	box of 50
<b>Three-ways catheters - balloon 30 ml - length 40 cm - soft valve</b>		
22077	3-way Foley catheter ch/fr 18 - balloon 30 ml	box of 50
22078	3-way Foley catheter ch/fr 20 - balloon 30 ml	box of 50
22079	3-way Foley catheter ch/fr 22 - balloon 30 ml	box of 50
22080	3-way Foley catheter ch/fr 24 - balloon 30 ml	box of 50

## RECTAL CATHETERS

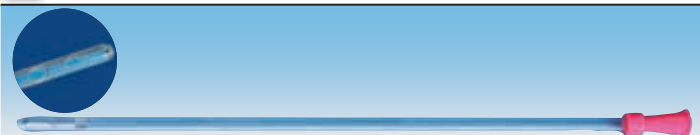

GIMA code	PVC STERILE RECTAL CATHETERS length: 38 cm - with conical adapter	Minimum order
22169	Rectal catheters ch/fr 22 - purple	box of 100
22170	Rectal catheters ch/fr 24 - dark blue	box of 100
22171	Rectal catheters ch/fr 26 - white	box of 100
22172	Rectal catheters ch/fr 28 - green	box of 100
22173	Rectal catheters ch/fr 30 - grey	box of 100

## CATHETER LUBRICANT GEL - STERILE

• **22104 CATHETER LUBRICANT GEL 12 ml - sterile - box of 25**  
Sterile, clear\*, water soluble gel used before applying catheter, cystoscope or other medical instrument to urethra. It covers urethra generating a slick layer between urethral mucosa and catheter or medical instrument. Antiseptic effect protecting patient from potential infection risk, it contains Lidocaine 2%, chlorhexidine 0.05%.

\*After Gamma sterilization it may change the colour over time from transparent to yellowish or pinkish.



## FOLEY CATHETERS - SILICONE



GIMA code	100% SILICONE STERILE FOLEY CATHETERS - SINGLE USE	Minimum order
<b>Two-way catheters - balloon 30 ml - length 40 cm</b>		
22096	2-way Foley catheter ch/fr 16 - balloon 30 ml	box of 10
22097	2-way Foley catheter ch/fr 18 - balloon 30 ml	box of 10
22098	2-way Foley catheter ch/fr 20 - balloon 30 ml	box of 10
22099	2-way Foley catheter ch/fr 22 - balloon 30 ml	box of 10
22100	2-way Foley catheter ch/fr 24 - balloon 30 ml	box of 10

## NELATON CATHETERS

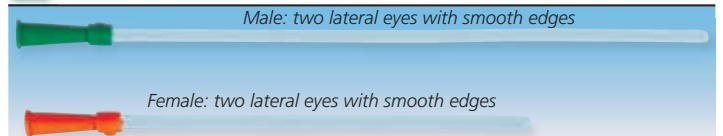

GIMA code	PVC DEHP FREE* STERILE NELATON CATHETERS two lateral eyes with smooth edges Single use	Minimum order
<b>MALE - length 38 cm</b>		
22003	Male Nelaton catheter ch/fr 10 - black	box of 100
22004	Male Nelaton catheter ch/fr 12 - white	box of 100
22005	Male Nelaton catheter ch/fr 14 - dark green	box of 100
22006	Male Nelaton catheter ch/fr 16 - orange	box of 100
22007	Male Nelaton catheter ch/fr 18 - red	box of 100
<b>FEMALE - length 18 cm</b>		
22022	Female Nelaton catheter ch/fr 8 - light blue	box of 100
22023	Female Nelaton catheter ch/fr 10 - black	box of 100
22024	Female Nelaton catheter ch/fr 12 - white	box of 100
22025	Female Nelaton catheter ch/fr 14 - dark green	box of 100
22026	Female Nelaton catheter ch/fr 16 - orange	box of 100

## SUCTION CATHETERS

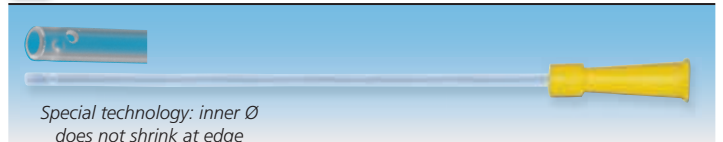

Length	PVC DEHP FREE* STERILE SUCTION CATHETERS with conical adapter	Minimum order	
50 cm	90 cm		
22110	22120	Suction catheter ch/fr 6 - light green	box of 100
22112	22122	Suction catheter ch/fr 8 - light blue	box of 100
22113	22123	Suction catheter ch/fr 10 - black	box of 100
22114	22124	Suction catheter ch/fr 12 - white	box of 100
22115	22125	Suction catheter ch/fr 14 - dark green	box of 100
22116	-	Suction catheter ch/fr 16 - orange	box of 100
22117	-	Suction catheter ch/fr 18 - red	box of 100
22118	-	Suction catheter ch/fr 20 - yellow	box of 100

\*DEHP is an additive used in the plastic industry for PVC which could be harmful to human reproductive system. Latex is totally DEHP free

## Z-STRAP 3 IN ONE - FOR FIXING URINE BAGS, TUBES OR CATHETERS

• **28727 Z-STRAP FIXING SYSTEM FOR URINE BAG, TUBE, CATHETER - box of 2**

Comfortable and discreet all in one universal strap for fixing a urine bag, a urine bag tube or a catheter. Special designed Z-strap is made of top-quality medical garment preventing irritations; silicone beading on internal side keeps the strap in place preventing any inconvenience.

- one size fits all (70 cm long), can be cut to desired size
- wide band (5 cm width), distributes pressure and weight better, especially for diabetics
- easy application, for nurse and user, fast wear and removal
- skin friendly, no use of adhesive / no need to shave hair
- fixing straps for drainage tubes to prevent slipping
- prevents injures caused by sudden movement

- fits all size of urine bags / leg bags
- reusable can be machine washed, does not shrink
- prevents pressure wounds, wide strap less pressure per cm<sup>2</sup>

Fixing for catheter

Fixing for tube

Fixing for urine bag

Fixing strap

28727



## URINE BAGS - WITH/WITHOUT NON RETURN VALVE

Standard urine bag (tube 90 or 130 cm)

**MADE IN SPAIN**

28690 - 28688

28692 - 28689

28708

Urine bag with non return valve (tube 90 or 130 cm)

28691 - 28694

28693 - 28695

Tips available for 28690/1/2/3 and 28707/8

GIMA code	STANDARD URINE BAGS	Minimum order
28690	Urine bag 2000 cc - tube 90 cm - polybag	box of 30*
28688	Urine bag 2000 cc - tube 90 cm - bulk	box of 250
28692	Urine bag 2000 cc - tube 130 cm - polybag	box of 30*
28689	Urine bag 2000 cc - tube 130 cm - bulk	box of 200

\*Polybag of 30 bags with tips (Italian reimbursement label) and 1 hanger

URINE BAGS WITH NON RETURN VALVE		
28691	Urine bag 2000 cc - tube 90 cm - polybag	box of 30*
28694	Urine bag 2000 cc - tube 90 cm - bulk	box of 250
28693	Urine bag 2000 cc - tube 130 cm - polybag	box of 30*
28695	Urine bag 2000 cc - tube 130 cm - bulk	box of 200

\*Polybag of 30 bags with tips (Italian reimbursement label) and 1 hanger

URINE LEG BAGS WITH NON RETURN VALVE		
28707	Urine leg bag 750 cc - tube 10 cm - polybag complete with push pull outlet device	box of 30**
28708	Urine leg bag 750 cc - tube 35 cm - polybag complete with push pull outlet device	box of 30**

\*\*Polybag of 30 bags with 1 set of button straps

Instructions in GB, FR, IT, ES, DE, PT, GR, PL. Non sterile.  
 Tube Ø: internal 5.05 mm, external 6.35 mm. Latex and DEHP free.



GIMA code	HANGER HOLDER FOR URINE BAGS	Minimum order
28698	Hanger holder with reusable cover for urine bag	box of 10
28699	Hanger holder for urine bag - blue - bulk	box of 200

## MALE EXTERNAL LATEX CATHETERS AND CATHETER FIXATIONS

Male external catheter

28710

Kit catheter + hydrocolloid strip in a pouch

28724

Hydrocolloid strip

28716

Foam strip

28715

28718

Safe & Secure elastic foam strap with pile and hook fastener which offers a non adhesive alternative for fastening the male external catheter

External male catheters made from natural medical latex. The graded cap design eliminates the possibility of twisting of the drainage system and blockage of the urine flow. No leaking or ballooning is possible.

Supplied in a 6 languages (GB, FR, IT, ES, PT, DE) polybag

GIMA code	MALE EXTERNAL LATEX CATHETERS	Size	Minimum order
28713	Male external catheter 20 mm	XS	box of 30
28709	Male external catheter Ø 25 mm	S	box of 30
28710	Male external catheter Ø 30 mm	L	box of 30
28711	Male external catheter Ø 35 mm	XL	box of 30
28712	Male external catheter Ø 40 mm	XXL	box of 30

KIT: MALE EXTERNAL CATHETER + ADHESIVE STRIP IN A POUCH			
28724	Kit: catheter Ø 30 mm + hydrocolloid strip	L	box of 30
28725	Kit: catheter Ø 35 mm + hydrocolloid strip	XL	box of 30

MALE EXTERNAL CATHETER FIXATIONS		
28715	Biadhesive foam strip 15x2x0.3 cm	box of 30
28716	Biadhesive hydrocolloid strip 12x1.8x0.1 cm	box of 30
28718	Safe & Secure reusable foam strap	bag of 3

## STERILE PAEDIATRIC URINE BAG FOR BOY AND GIRL



• 28685 PAEDIATRIC URINE BAG 100 ml - sterile - box of 100  
 Paediatric urine bag, individually wrapped in polybag. They can be used for boy and girl. Graduated 10 to 100 ml, sterile.



## STERILE MEDICATION, SUTURE, CATHETERIZATION KITS



• 26930 DRESSING KIT 1 - sterile



• 26929 DRESSING KIT 2 - sterile



• 26933 CATHETERIZATION KIT - sterile



• 26936 SUTURE REMOVAL KIT 1 - sterile



• 26945 SUTURE REMOVAL KIT 2 - sterile



• 26932 SUTURE REMOVAL KIT 3 - sterile

KIT CONTENT	Dressing		Suture		Suture removal			Catheters
	26930	26929	26931	26949	26932	26936	26945	26933
Field cloth	•				•			•
Cushing surgery forceps				•				
Needle Holder				•				
Kocher forceps				•				
Anatomy forceps	•		•		•			
Plastic forceps				•		•		•
Haemostatic flow clamp		•						
Ring shaped forceps	•	•	•		•			•
Styptic clamp (Kelly forceps)			•					
Haemostatic clamp				•				
Straight scissors				•				
Metal forceps with plastic ends		•		•				
Littauer scissors		•		•	•	•		
Gauze swabs 7.5x7.5 cm 8 ply	•	•	•		•			
Gauze swabs 10x10 cm 8 ply				•	•			
4 or 5 Gauze plugs	•		•	•	•			
3 Gauze plugs		•						•
Gauze swabs 10x20 cm - 16 plies		•						
Gauze swab 18x40 cm					•			
Latex gloves - medium								
Vinyl gloves					•			•
Disposable big bag			•		•			•
Medication plaster 15x12 cm					•			•
WNW (TNT)+PE drape 32x50 cm		•						
WNW (TNT)+PE drape 50x60 cm				•				
WNW (TNT) compresses								•
WNW (TNT)+PE drape 50x60 cm with hole				•				•
Water syringe								•
Single dose lubricant								•
2 disinfectant wipes								•
Isopropyl alcohol wipe								•
2 adhesive WNW (Woven Non Woven) strips				•				
Waste bag		•						
Scalpel with handle								•
2 cotton applicators								•
PE bag minigrip				•				



• 26931 SUTURE KIT 1 - sterile



• 26949 SUTURE KIT 2 - sterile

Label/instructions in GB, IT for 26930-1-2-3

## GENERAL SURGERY PROCEDURE PACK



26985

### • 26985 GENERAL SURGERY PACK - sterile

Ready to use pack including all necessary for a general surgery procedure.

Peel open PE + tyvek envelope.

Sterile EO.

#### KIT CONTENT

1 table cover 160x200 cm	4 hand towels
2 surgical gowns XL (1 standard, 1 reinforced)	1 bowl 120 ml
2 adhesive drapes 75x90 cm	1 kidney dish
1 foot drape (ADH side) 150x180 cm	1 scalpel n°15
1 head drape (ADH side) 150x240 cm	5 gauze swabs 10x20 cm
2 syringes 10 ml	4 gauze balls 30 mm
2 needles 21Gx1.5"	2 foam sticks 15 cm
1 scalpel n°11	1 basic tray

## SURGICAL SKIN MARKER - STERILE

- **33181 P3 SKIN MARKER® - fine tip - sterile - box of 10**

The P3® Surgical Skin Marker features a versatile tip for precise fine line marking preferred in plastic surgery or when held at an angle, broad line marking for applications in general, neuro and vascular surgery, as well as radiology and radiation therapy. The marker's high visibility Gentian violet ink is non-toxic, non tattooing and surgical prep-resistant. Markings can be removed from the skin with isopropyl (rubbing) alcohol. The package is easy to open, HIBC bar coded and includes a separate six inch, flexible ruler calibrated in both inches and centimeters. Sterile EO. Individually packed.

CE 0169



33181

TWO TIPS IN ONE:



For heavier lines, hold the pen at an angle and use the shoulder of the tips (2 mm)



Hold the pen vertically while applying a fine line (0.2 mm)

MADE IN GREAT BRITAIN

## SURGICAL SKIN MARKERS - STERILE

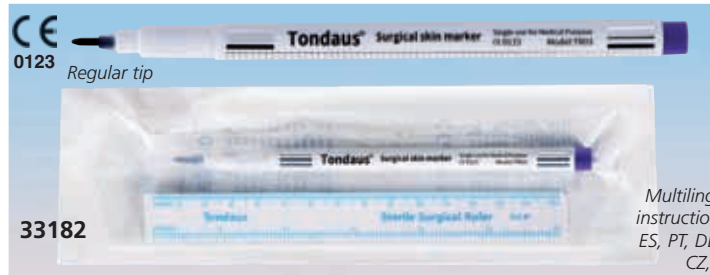

CE 0123  
Regular tip

33182

Multilingual box and instructions: GB, FR, IT, ES, PT, DE, NL, DK, PL, CZ, FI, GR.



CE 0123  
Fine tip Regular tip

33183

- **33182 SURGICAL SKIN MARKER - single tip - sterile - box of 100** Single tip marker ideal for plastic surgery. Hypoallergenic and violet non-toxic ink. Marking can be removed by alcohol and liquid soap. Intended for single use. Includes a separate six inch, flexible ruler calibrated in both inches and centimeters. Individually packed.

TECHNICAL SPECIFICATIONS	
Tip size:	1.0 mm
Diameter:	9.5 mm
Length:	167 mm
Ink colour:	violet
Washable:	no

- **33183 SURGICAL SKIN MARKER - double tip - sterile - box of 100** Double tip marker ideal for plastic surgery. Hypoallergenic and violet non-toxic ink. Marking can be removed by alcohol and liquid soap. Intended for single use. Includes a separate six inch, flexible ruler calibrated in both inches and centimeters. Individually packed.

TECHNICAL SPECIFICATIONS	
Tip size:	fine tip: 0.5mm
Diameter:	11 mm
Length:	140 mm
Ink colour:	violet
Washable:	no

## SKIN MARKER

- **33179 SKIN MARKER - dual tips gentian violet - box of 10** Double tip skin marker with polypropylene cap and body. Polyester fiber tips. **Ultra fine tip utility marker** to write on adhesive labels and infusion bags.

Multilingual box and manual: GB, FR, IT, DE, ES, PT, GR, PL, SE, RO, HU, Arabic.



33179

- **Regular tip surgical skin marker** for use on patient skin. Washable with water and soap. Size 138xØ 12.5 mm.



With ruler in mm

33179

Ultra fine tip

Regular tip

## DERMATOGRAPH MARKERS

- **33175 DERMATOGRAPH MARKER - blue - box of 6**
- **33176 DERMATOGRAPH MARKER - white - box of 6**
- **33177 DERMATOGRAPH MARKER - red - box of 6**
- **33178 DERMATOGRAPH MARKER - mixed colours - box of 6\***

\*2 pencils each colour

Special dermatograph pencil to mark the skin for identification of areas to be treated.

Made of cedar wood with wax lead. Size 175xØ 7 mm. Suitable for general surgery, dermatology, orthopaedy, radiology, ...

Pencils are sold non sharpened in box of 6 with 1 pencil sharpener included.

Multilingual box and manual:

GB, FR, IT, DE, ES, PT, GR, PL, SE, RO, HU, Arabic.

CE



33175

33176



33177

33178



## SUTURE TRAINING PAD

• **23020 SUTURE TRAINING PAD with wounds with mesh**  
Silicone suture training pad with 14 wounds. 3 layers: skin, subcutis, muscle (extra layer mesh under the skin). Soft true to life skin texture. Multilingual label and manual: GB, FR, IT, ES, PT.

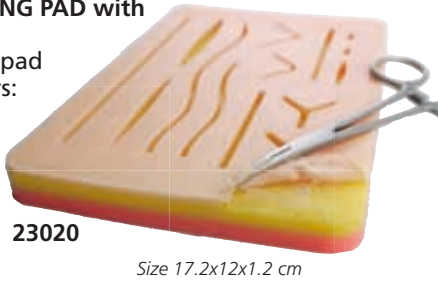

23020

Size 17.2x12x1.2 cm

## SUTURE TRAINING KIT

• **23022 SUTURE TRAINING KIT**  
Suture training kit includes: silicone pad (23020), 6 tools and 4 blades made of stainless steel, 8 sutures and a black PVC leather case. Intended for teaching and training only, not for human or vet use. Multilingual label and manual: GB, FR, IT, ES, PT, DE, SE, DK, GR, RO.



Kit size 19.5x22.5x3.5 cm

## 3M STERI-STRIP™

Adhesive skin closure strips, sterile, breathable and comfortable to wear. See page 410 for: 3M reinforced or elastic Steri-strip, suture strips



1 Case		STANDARD ACCESSORIES	
1 Suture pad	1 Scalpel handle n.3 - 12.5 cm	1 Mosquito forcep - 12.5 cm	8 Sutures:
6 Instruments:	1 Dressing forcep - 12.5 cm	1 Needle holder - 12.5 cm	2 Nylon sutures 3/0
1 Adson forcep - 12.5 cm	4 Blades:	1 Needle holder - 12.5 cm	2 Nylon sutures 4/0
1 Iris scissor - 12.5 cm	2 Scalpel blades n.10	1 Adson forcep - 12.5 cm	2 Silk sutures 3/0
	2 Scalpel blades n.11	1 Iris scissor - 12.5 cm	2 Silk sutures 4/0

## SUTURES COMPARISON HEALTHIUM - ETHICON - B.BRAUN

GENERIC NAME OF SUTURES	Healthium	ETHICON	B BRAUN SHARING EXPERTISE
CATGUT PLAIN & CHROMIC	-	GUT SUTURE PLAIN & CHROMIC	-
POLYGLYCOLIC ACID	TRUGLYDE	-	SAFIL
FAST ABSORBING POLYGLYCOLIC ACID	TRUGLYDE FAST	-	SAFIL QUICK
POLYGLACTIN 910	TRUSYNTH	VICRYL	NOVONSYN
FAST ABSORBING POLYGLACTIN 910	TRUSYNTH FAST	VICRYL RAPID	-
ANTIBACTERIAL COATED POLYGLACTIN 910	-	VICRYL PLUS	-
MONOFILAMENT POLYDIOXANONE	PD SYNTH	PDS OR PDS II	MONOPLUS
MONOFILAMENT POLIGLECAPRONE 25	MONOGLYDE	MONOCRYL	MONOSYN
MONOFILAMENT POLYAMIDE NYLON	TRULON	ETHILON / NUROLON	DAFILON
BRAIDED & COATED SILK	TRUSILK	MERSILK / PERMA-HAND SILK	SILKAM
MONOFILAMENT POLYPROPYLENE	TRULENE	PROLENE	PREMILENE/OPTILENE
BRAIDED & COATED POLYESTER	TRUBOND	ETHIBOND/MERSILENE	PREMICRON/DAGROFIL
STEEL SUTURES	TRUSTEEL	ETHISTEEL	STEELEX
BARB SUTURES	TRUBARB	STRAFATIX	-

## SURGICAL NON ABSORBABLE SUTURES - STERILE

**TRUBOND - non absorbable surgical suture, silicone coated and braided polyester for permanent support and strength**  
Equivalent Ethicon brand: ETHIBOND

### Technical details:

- braided polyester, coated with silicone for a smooth knot tie down
- high tensile strength for reliability
- low tissue reactivity - undergoes no significant change in body
- excellent handling and long lasting
- sterilized by ethylene oxide
- shelf life of 5 years

### Applications:

- used for permanent and removable fixtures
- prosthetic implantations
- "Face lifts"
- cardiovascular surgery
- ideal for valve repair/ replacement

Multilingual manual and box: GB, FR, IT, ES, PT, DE, GR.



**TRUSTEEL - non absorbable monofilament steel surgical suture**  
Equivalent Ethicon brand: ETHILSTEEL

### Technical details:

- monofilament stainless steel LVM 316 grade wire
- optimal compatibility with body tissue
- low or no tissue reactivity
- non-adhering and biologically inert
- sterilized by ethylene oxide
- shelf life of 5 years

### Applications:

- orthopedic surgeries
- sternum closure

Multilingual manual and box: GB, FR, IT, ES, PT, DE, GR.



TRUBOND - box of 12							
GIMA code	Gauge	Metric	Colour	Cirde	Needle profile	Needle length	Suture length
22770	2/0	3	Green	1/2	Taper cutting double arm	17 mm	90 cm
22771	3/0	2	Green	1/2	Round body	25 mm	90 cm
22772	3/0	2	Green	3/8	Cutting	16 mm	38 cm
22773	4/0	1.5	Green	3/8	Round body	16 mm	76 cm
22774	5/0	1	Green	3/8	Round body double arm	20 mm	76 cm
22775	0	3.5	Green	1/2	Reverse cutting	50 mm	100 cm
22776	1	4	Green	1/2	Reverse cutting	50 mm	100 cm
22777	2	5	Green	1/2	Taper cutting heavy	45 mm	100 cm
22778	5	7	Green	1/2	Trocar point heavy	55 mm	100 cm

TRUSTEEL - box of 48							
GIMA code	Gauge	Metric	Colour	Cirde	Needle profile	Needle length	Suture length
22790	1	4	Natural	1/2	Round body blunt point	40 mm	45 cm
22791	2	5	Natural	1/2	Taper cutting	40 mm	45 cm
22792	4	6	Natural	1/2	Conventional cutting	48 mm	45 cm
22793	5	7	Natural	1/2	Taper cutting	48 mm	45 cm
22794	6	8	Natural	1/2	Round body blunt point	44 mm	45 cm
22795*	6	8	Natural	1/2	Conventional cutting	48 mm	75 cm
22796	7	9	Natural	1/2	Conventional cutting	48 mm	45 cm

\*This code only is sold in box of 24

## SURGICAL NON ABSORBABLE SUTURES - STERILE

**TRULON - polyamide nylon non absorbable monofilament suture**

**Equivalent Ethicon brand: ETHILON / NUROLON**

**Technical details**

- monofilament polyamide
- non-adhering and biologically inert
- sterilized by ethylene oxide
- shelf life of 5 years

**Applications**

- for cuticular and subcuticular closure
- orthopedic surgery
- ophthalmic
- general closure
- micro surgery

Multilingual manual and box: GB, FR, IT, ES, PT, DE, GR.



TRULON - box of 12							
GIMA code	Gauge	Metric	Colour	Circle	Needle profile	Needle length	Suture length
22800	2/0	3.0	Blue	3/8	Reverse Cutting	26 mm	45 cm
22801	2/0	3.0	Black	3/8	Reverse Cutting	45 mm	70 cm
22803	3/0	2.0	Blue	3/8	Conventional Cutting	20 mm	45 cm
22804	3/0	2.0	Blue	3/8	Reverse Cutting	24 mm	45 cm
22805	3/0	2.0	Blue	3/8	Conventional Cutting	25 mm	45 cm
22807	3/0	2.0	Black	3/8	Reverse Cutting	19 mm	45 cm
22808	3/0	2.0	Black	3/8	Reverse Cutting	24 mm	45 cm
22810	4/0	1.5	Blue	3/8	Reverse Cutting	19 mm	45 cm
22811	4/0	1.5	Black	3/8	Conventional Cutting	10 mm	38 cm
22812	4/0	1.5	Black	3/8	Reverse Cutting	19 mm	45 cm
22814	5/0	1.0	Blue	3/8	Reverse Cutting	16 mm	70 cm
22815	5/0	1.0	Blue	3/8	Reverse Cutting	19 mm	70 cm
22816	5/0	1.0	Black	3/8	Reverse Cutting	19 mm	45 cm
22817	5/0	1.0	Black	3/8	Reverse Cutting	19 mm	75 cm
22820	6/0	0.7	Blue	3/8	Reverse Cutting	12 mm	45 cm
22821	6/0	0.7	Blue	3/8	Reverse Cutting	16 mm	45 cm
22822	6/0	0.7	Black	3/8	Reverse Cutting	16 mm	45 cm

**TRUSILK - braided black silk non absorbable multifilament suture**

**Equivalent Ethicon brand: MERSILK / PERMA-HAND SILK**

**Technical details**

- made from 100% protein fiber spun
- coating of wax/silicone
- sterilized by ethylene oxide
- shelf life of 5 years

**Applications**

- general surgery
- ophthalmic surgery
- cardiovascular surgery
- gastrointestinal surgery
- orthopedic surgery

Multilingual manual and box: GB, FR, IT, ES, PT, DE, GR.



TRUSILK - box of 12							
GIMA code	Gauge	Metric	Colour	Circle	Needle profile	Needle length	Suture length
22830	0	3.5	Black	1/2	Round Body	30 mm	76 cm
22831	2/0	2.0	Black	1/2	Taper Cutting	19 mm	75 cm
22832	2/0	3.0	Black	3/8	Reverse Cutting	26 mm	45 cm
22833	2/0	3.0	Black	1/2	Reverse Cutting	22 mm	45 cm
22834	2/0	3.0	Black	1/2	Taper Cutting	25 mm	75 cm
22835	2/0	3.0	Black	1/2	Round Body	30 mm	76 cm
22836	3/0	2.0	Black	1/2	Conventional Cutting	22 mm	45 cm
22837	3/0	2.0	Black	1/2	Round Body	22 mm	45 cm
22838	3/0	2.0	Black	3/8	Reverse Cutting	19 mm	70 cm
22839	3/0	2.0	Black	3/8	Reverse Cutting	24 mm	45 cm
22840	3/0	2.0	Black	1/2	Taper Cutting	19 mm	75 cm
22842	3/0	2.0	Black	1/2	Taper Cutting	25 mm	75 cm
22844	4/0	1.5	Black	1/2	Reverse Cutting	17 mm	45 cm
22845	4/0	1.5	Black	1/2	Taper Cutting	19 mm	75 cm
22846	4/0	1.5	Black	1/2	Taper Cutting	25 mm	75 cm
22847	4/0	1.5	Black	Straight	Round Body	19 mm	45 cm
22848	4/0	1.5	Black	3/8	Reverse Cutting	13 mm	45 cm
22849	4/0	1.5	Black	3/8	Reverse Cutting	19 mm	45 cm
22851	5/0	1.0	Black	3/8	Reverse Cutting	19 mm	70 cm
22852	6/0	0.7	Black	3/8	Reverse Cutting	16 mm	45 cm

**TRULENE - monofilament non absorbable suture - polypropylene**

**Equivalent Ethicon brand: PROLENE**

**Technical details**

- monofilament polypropylene
- non-adhering and biologically inert
- sterilized by ethylene oxide
- shelf life of 5 years

**Applications**

- hernia repair
- permanent fixtures
- general surgery
- micro surgery
- orthopedic surgery
- cardiovascular surgery
- plastic surgery
- can also be used in ophthalmic and neurological procedures

Multilingual manual and box: GB, FR, IT, ES, PT, DE, GR.



TRULENE - box of 12							
GIMA code	Gauge	Metric	Colour	Circle	Needle profile	Needle length	Suture length
22870	1	4.0	Blue	1/2	Round Body	30 mm	70 cm
22871	0	3.5	Blue	1/2	Round Body	30 mm	70 cm
22872	2/0	3.0	Blue	3/8	Reverse Cutting	24 mm	70 cm
22874	3/0	2.0	Blue	3/8	Reverse Cutting	24 mm	70 cm
22875	3/0	2.0	Blue	Straight	Conventional Cutting	60 mm	70 cm
22877	4/0	1.5	Blue	3/8	Reverse Cutting	19 mm	45 cm
22879	4/0	1.5	Blue	3/8	Reverse Cutting	19 mm	75 cm
22881	5/0	1.0	Blue	3/8	Reverse Cutting	16 mm	70 cm
22882	5/0	1.0	Blue	3/8	Reverse Cutting	19 mm	70 cm
22884	6/0	0.7	Blue	3/8	Reverse Cutting	13 mm	45 cm
22885	6/0	0.7	Blue	3/8	Conventional Cutting	16 mm	45 cm

## SURGICAL ABSORBABLE SUTURES - STERILE

**TRUBARB - absorbable surgical needled-suture (synthetic) knotless tissue-closure device**

**Equivalent Ethicon brand: PDS OR PDS II**

**Technical details**

- monofilament polydioxanone
- secure and effective triangular end-stopper
- single angle cut uni-directional helical barb design
- world class 300 series QNPL needle
- sterilized by ethylene oxide
- shelf life of 3 years

**Applications**

- gynaecological and urology procedures
- general surgery procedures
- oncology procedures
- plastic and cosmetic surgeries

Multilingual manual and box: GB, FR, IT, ES, PT, DE, GR.



TRUBARB - box of 6							
GIMA code	Gauge	Metric	Colour	Circle	Needle profile	Needle length	Suture length
22890	0	3.5	Violet	1/2	Taper point	37 mm	30 cm
22891	0	3.5	Violet	1/2	Taper point	37 mm	45 cm
22892	2/0	3	Violet	1/2	Taper point	37 mm	30 cm
22893	2/0	3	Violet	1/2	Taper point	37 mm	45 cm
22894	2/0	3	Violet	1/2	Taper point	26 mm	30 cm
22895	3/0	2	Violet	1/2	Taper point	26 mm	45 cm
22896	3/0	2	Violet	3/8	Reverse cutting	19 mm	45 cm





## DISPOSABLE SKIN STAPLER



Multilingual manual and box:  
GB, FR, IT, ES, PT, DE.

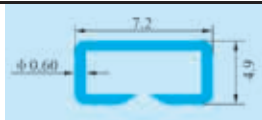

- **25891 DISPOSABLE STERILE SKIN STAPLER - box of 5**  
Easy to use device with 35 staples made of High Quality 317 L Stainless Steel for medical use. High sewing up and stapling speed help shorten the time of sewing and avoid cross infection of contagious diseases. Reduced tissue reaction, thinner scar after operation and faster wound healing. Painless and convenient staples removal after the incision has healed up. For skin closure in operating room, delivery, emergency, outpatient surgery, clinics and physician's office.

## 3M™ PRECISE™ SKIN STAPLERS

- **25896 3M PRECISE™ SKIN STAPLER 5 staples - sterile - box of 12**
- **25897 3M PRECISE™ SKIN STAPLER 15 staples - sterile - box of 12**

The disposable Precise skin staplers offer numerous benefits over sutures

- significantly quicker, simpler to use and safer than sutures
- better cosmetic effect
- six times faster than suturing
- no risk of accidental stick injury
- less painful than sutures
- easy to remove.

It comes pre-loaded with 5 or 15 staples (6.5x4.5 mm). Suitable for simple, recent, open, unbruised wounds. Staples are particularly suitable for scalp wounds as they do not catch on surrounding hair and are more easily identifiable at the time of removal.



## SKIN STAPLE REMOVERS

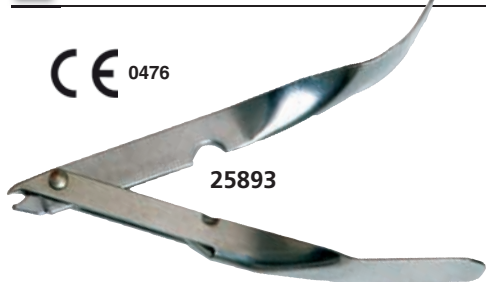

25893

- **25893 DISPOSABLE SKIN STAPLE REMOVER 11 cm - sterile - box of 50**  
Suitable for use with most brands of skin staples. It combines functionality with cost effectiveness.

26722

26737

- **26737 S/S SPENCER SCISSORS - 13 cm**
- **26722 S/S MICHEL STITCH REMOVER FORCEPS - 12 cm**



- **25892 DISPOSABLE REMOVER FORCEPS - sterile - box of 20 pcs.**  
Practical disposable forceps for removing regular and wider size staples. Plastic handle and stainless steel tips.



25895

- **25895 SR-3 DISPOSABLE SKIN STAPLE REMOVER - sterile - box of 10 pcs.**  
The scissor-like action of the 3M SR-3 provides ergonomic grip and removes staples in the same direction they were implanted, making removal simple. Plastic handle and stainless steel tips.

## BONEWAX - STERILE

- **23000 TRUWAX STERILE SURGICAL BONEWAX 2.5 g - box of 12**

Equivalent Ethicon brand: **BONE WAX**

Truwax is a sterile bone wax used to control bleeding from bone surfaces during surgical procedures by providing hemostasis from bone injuries and cuts. It works like a mechanical barrier, through a tamponade effect, it blocks pores and channels of cut or damaged bone. Made from sterile mixture of beeswax paraffin wax and isopropyl palmitate. Materials ensure excellent malleability.

23000

Multilingual manual and box:  
GB, FR, IT, ES, PT, DE, GR.

### TECHNICAL SPECIFICATIONS

Composition:	Bees wax I.P., White Hard Paraffin Wax, I.P., Iso Propyl Palmitate, U.S.P.
Colour - Odour:	opaque - waxy odour
Sterilization:	gamma radiation
Shelf life:	5 years
Packing:	2.5 g per unit pack



## CLINICEL OXIDIZED REGENERATED CELLULOSE

CLINICEL OXIDIZED REGENERATED CELLULOSE

Equivalent Ethicon brand: **SURGICEL**

Features

- absorbable hemostat
- made from oxidized regenerated cellulose (plant based product)
- malleable and flexible

Applications

- Neurosurgery: operative intervention into the cerebrum, ventricular system, spinal surgery
- Cardiac Surgery: valve replacement surgery, sterna medullary bleeding, approaches to the skull base, cerebrovascular surgery
- Gynecological surgeries: uterine wall perforation
- ENT: posterior epistaxis
- General surgeries: iatrogenic perforations

### TECHNICAL SPECIFICATIONS

Effective Hemostasis:	in 3-5 minutes
Sterilization:	gamma radiation
Shelf life:	3 years



23005



23008

Multilingual manual and box:  
GB, FR, IT, ES, PT, DE, GR.

GIMA code	CLINICEL STANDARD - box of 6	cm	inches
23003	Clinicel standard	5.1x7.6	2x3
23004	Clinicel standard	5.1x35.5	2x14
23005	Clinicel standard	10x20	4x8
GIMA code	CLINICEL FIBRIL TYPE - box of 6	cm	inches
23007	Clinicel fibril type	2.5x5.1	1x2
23008	Clinicel fibril type	5.1x10	2x4



## SURGICAL PREP USE RAZORS - STAINLESS STEEL BLADE



27081



27082

GIMA code	NON STERILE DISPOSABLE RAZORS stainless steel blades	Blade length	Minimum order
27080	Single blade - 98.6x41 mm	35 mm	box of 100
27081	Double blade - 98.6x41 mm	35 mm	box of 100
27082	Single blade with comb - 103x47 mm	38 mm	box of 50

### NON STERILE DISPOSABLE RAZORS

Non sterile razors with stainless steel blade.  
All razors are supplied in a multilingual dispenser box:  
GB, FR, IT, ES, PT, DE, GR, PL, SE, RO.

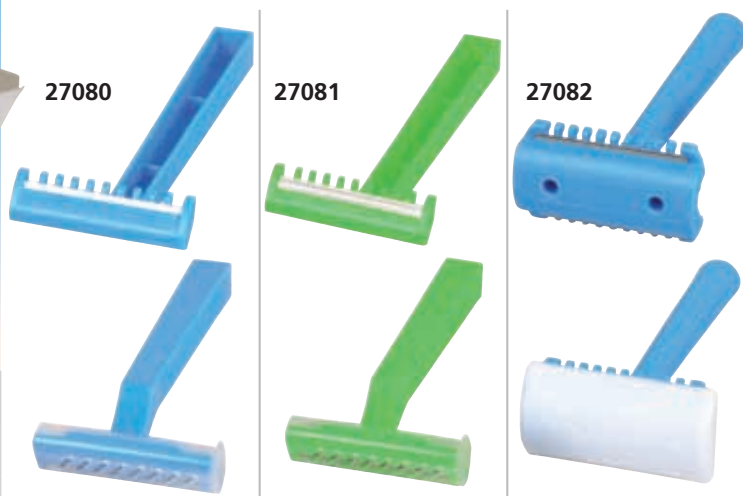

## 3M™ SURGICAL CLIPPER WITH PIVOTING HEAD\*



Ergonomic handle with pivoting head\* and charger



27054

### • 27054 3M™ SURGICAL CLIPPER STARTER KIT (CLIPPER + CHARGER) - 9667L-E

The 3M surgical clipper with its unique pivoting head\* is a safe, reliable and easy to use device providing a comfortable clipping experience for patients. \*When used with 3M clipper blades 9660 (27055)

### SURGICAL CLIPPER FEATURES WITH DIFFERENT SURGICAL CLIPPER BLADES

	27055	27056
Pivoting head	✓	✓
Ergonomically designed handle that's easy to hold	✓	✓
Easy-to-attach blade	✓	✓
Cuts through all types of head and body hair, wet or dry, in a single pass	✓	✓
Quickly and effectively removes hair in trauma and neuro cases	✓	✓
Away-from-the-skin cutting blade minimizes potential for nicks or cuts, which helps reduce the risk of SSIs (surgical site infections)	✓	✓
Li-ion battery designed to hold a charge longer and battery indicator light	✓	✓
Approximately 160 minutes of run time on a four-hour recharge	✓	✓
Submersible for easy cleaning (meets IPX7 rating of submersible in water no deeper than 1 m for up to 30 min)	✓	✓

### • 27055 3M™ SURGICAL CLIPPER BLADES - 9660 - pivoting - box of 50

### • 27056 3M™ SURGICAL CLIPPER BLADES - 9690 - non pivoting - box of 20

Single use clipper blade individually sealed



27055

Clipper blade for head and heavy body hair



27056



## SURGICAL NON ABSORBABLE MESH - TRANSPARENT -STERILE



Multilingual manual and box:  
GB, FR, IT, ES, PT, DE, GR.

### TRULENE (Polypropylene) MESH - Non-Absorbable

Equivalent Ethicon brand: PROLENE MESH

#### Features

- non-adhering to tissue and biologically inert
- gives strong support for indefinite periods
- excellent tensile strength and pliability
- easy to draw through tissues
- inert material
- does not harbor micro-organisms
- least thrombogenic

#### Applications

- hernia repair, plastic, general and gastrointestinal surgery

#### Technical details

- monofilament polypropylene non-absorbable surgical sutures
- the product does not require any coating is sold untreated
- sterilized by ethylene oxide
- Shelf life of 5 years.

TRULENE MESH - non absorbable		
GIMA code	Size	Minimum order
23012	6 x 11 cm	box of 6
23013	7.6 x 15 cm	box of 6
23014	10 x 15 cm	box of 3
23015	15 x 15 cm	box of 3
23016	30 x 30 cm	box of 1

# GIMA DISPOSABLE STAINLESS STEEL OR CARBON STEEL BLADES

"GIMA" DISPOSABLE BLADES - sterile - dispenser box of 100  
Surgical blades are available in high quality carbon steel or stainless steel. Manufactured in accordance with the requirements of British Standards BS 2982:1992, ISO 7740:1985, ISO 7153-1: 1991, EN 10088-3: 2005.

Each blade is hallmarked and individually packed in aluminium foil. Carbon Steel blades are VPI paper protected.

Blade size is clearly identified on the reverse side of the foil peel-pack and on product unit boxes.

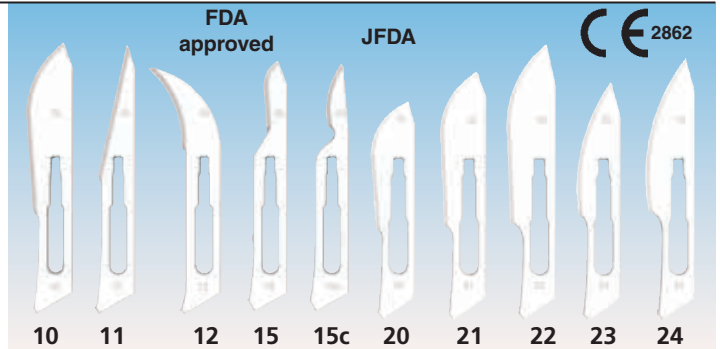

Carbon steel	Stainless steel	Diamantine stainless steel	GIMA STERILIZED BLADES	Minimum order
27000	27020	27010	Sterilized blades N. 10	box of 100
27001	27021	27011	Sterilized blades N. 11	box of 100
27002	27022	-	Sterilized blades N. 12	box of 100
27003	27023	27013	Sterilized blades N. 15	box of 100
27009	-	-	Sterilized blades N. 15c	box of 100
27004	27024	27014	Sterilized blades N. 20	box of 100
27005	27025	27015	Sterilized blades N. 21	box of 100
27006	27026	27016	Sterilized blades N. 22	box of 100
27007	27027	27017	Sterilized blades N. 23	box of 100
27008	27028	27018	Sterilized blades N. 24	box of 100



GIMA code	SCALPEL HANDLES - STAINLESS STEEL	
26913	Scalpel Handle N° 3 for blades 10-15	
26914	Scalpel Handle N° 4 for blades 20-25	

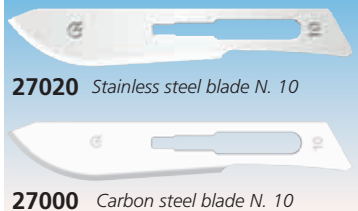

27020 Stainless steel blade N. 10

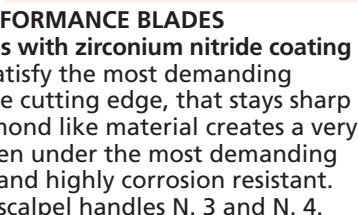

27000 Carbon steel blade N. 10

## DIAMANTINE™ EDGE HIGH PERFORMANCE BLADES

High quality, super sharp blades with zirconium nitride coating fused on the cutting edge to satisfy the most demanding surgeons requirements. Durable cutting edge, that stays sharp incision after incision. The diamond like material creates a very hard edge that will not dull even under the most demanding cutting needs. Bio-compatible and highly corrosion resistant. Compatible with autoclavable scalpel handles N. 3 and N. 4. Stainless steel, sterile.



**DIAMANTINE EXTRA SHARP COATED BLADES**  
(hardness > 2,500 Vickers)

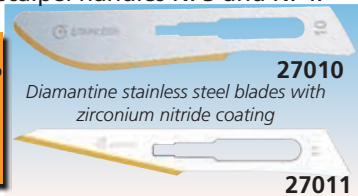

27010 Diamantine stainless steel blades with zirconium nitride coating

27011

# GIMA DISPOSABLE STAINLESS STEEL SCALPELS

"GIMA" DISPOSABLE SCALPELS - sterile - box of 10  
S/S blade fitted into an ABS plastic handle. Individually packed in sterilized envelope. Safety blade guard.

"GIMA" SAFETY PROTECTIVE SHIELD SCALPELS - sterile  
Protective scalpels with a clear view shield that protects against injuries before use, between steps of procedure and after disposal. Latex and phthalates free.

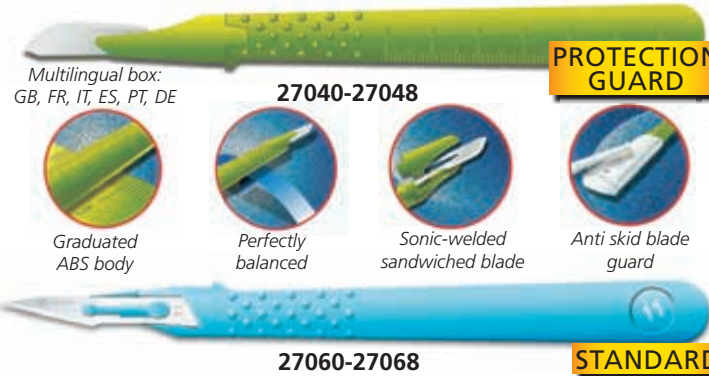

Multilingual box:  
GB, FR, IT, ES, PT, DE

27040-27048

**PROTECTION GUARD**



Graduated ABS body

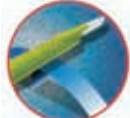

Perfectly balanced



Sonic-welded sandwiched blade



Anti skid blade guard

27060-27068

**STANDARD**

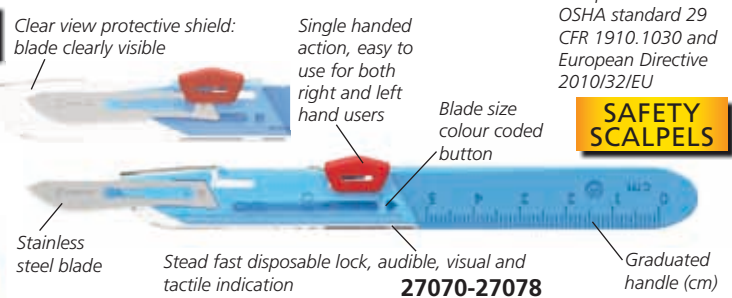

Clear view protective shield:  
blade clearly visible

Single handed action, easy to use for both right and left hand users

Blade size colour coded button

Complies with US OSHA standard 29 CFR 1910.1030 and European Directive 2010/32/EU

**SAFETY SCALPELS**

Stainless steel blade

Stead fast disposable lock, audible, visual and tactile indication

27070-27078

Graduated handle (cm)

Multilingual box and instructions: GB, FR, IT, ES, PT, DE, RU, RO, PL, SE, GR, Arabic

Protection guard	Standard	Safety	Diamantine high performance	GIMA STERILIZED DISPOSABLE STAINLESS STEEL SCALPELS (box of 10 pcs.)
27040	27060	27070	22460	Disposable scalpels - blade 10
27041	27061	27071	22461	Disposable scalpels - blade 11
27042	27062	-	-	Disposable scalpels - blade 12
27043	27063	27073	22463	Disposable scalpels - blade 15
27049	-	-	-	Disposable scalpels - blade 15c
27044	27064	27074	22464	Disposable scalpels - blade 20
27045	27065	27075	22465	Disposable scalpels - blade 21
27046	27066	27076	22466	Disposable scalpels - blade 22
27047	27067	27077	22467	Disposable scalpels - blade 23
27048	27068	27078	22468	Disposable scalpels - blade 24

## DIAMANTINE HIGH PERFORMANCE SCALPELS - sterile

High-Performance Edge blade for extreme and durable sharpness  
- sensory grip handle enhances cutting action and control of the line of incision  
- each handle has a graduated 6 cm ruler to help determine incision length (indicative only)  
- protective sheath covers blade to help prevent accidental cuts  
- latex and phthalates free

**DIAMANTINE HIGH PERFORMANCE SCALPELS**

## • 27058 STITCH CUTTER - sterile - box of 10



27058 Disposable stainless steel stitch cutter



Stainless steel Diamantine Edge high performance coated blade. Hardness over 2,500 Vickers

22460-22468

Size is clearly marked on blade and handle for easy identification

# SWANN-MORTON DISPOSABLE BLADES, SCALPELS AND STITCH CUTTERS

## SWANN-MORTON DISPOSABLE BLADES AND SCALPELS

Swann-Morton blades and scalpels are renowned their exceptional quality, precision, consistency and reliability. Swann-Morton manufactures in the UK using high quality

### STANDARD SCALPELS

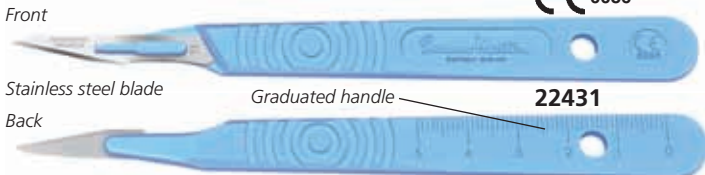

Plastic handle scalpels with stainless steel blades, individually packed in sterilized envelope in box of 10 pcs. Multilingual box: GB, FR, IT, ES, DE, DK, NL, GR, PT, PL, FI, RU, NO, SE.

GIMA code	SWANN-MORTON SCALPELS WITH S/S BLADE	Minimum order
22430	Disposable scalpels - blade 10 - sterile	box of 10
22431	Disposable scalpels - blade 11 - sterile	box of 10
22432	Disposable scalpels - blade 12 - sterile	box of 10
22433	Disposable scalpels - blade 15 - sterile	box of 10
22435	Disposable scalpels - blade 20 - sterile	box of 10
22436	Disposable scalpels - blade 21 - sterile	box of 10
22437	Disposable scalpels - blade 22 - sterile	box of 10
22438	Disposable scalpels - blade 23 - sterile	box of 10
22439	Disposable scalpels - blade 24 - sterile	box of 10

### SAFETY SCALPELS WITH RETRACTABLE BLADE



GIMA code	SWANN-MORTON SCALPELS WITH RETRACTABLE STAINLESS STEEL BLADE	Minimum order
22440	Disposable scalpels - blade 10 - sterile	box of 25
22441	Disposable scalpels - blade 11P - sterile	box of 25
22443	Disposable scalpels - blade 15 - sterile	box of 25
22448	Disposable scalpels - blade 23 - sterile	box of 25



GIMA code	STITCH CUTTER WITH RETRACTABLE S/S BLADE	Minimum order
22450	Stitch cutter with retractable blade - sterile	box of 25

steel that gives exceptional cutting performance. They operate stringent quality control procedures which ensure unrivalled blade consistency and reliability. This is why Swann-Morton is the preferred choice of many medical professionals worldwide.



Carbon steel blades individually packed in metal foil and box of 100

GIMA code	SWANN-MORTON CARBON STEEL BLADES - STERILE - box of 100
22400	Blade 10
22401	Blade 11
22402	Blade 12
22403	Blade 15
22405	Blade 20
22406	Blade 21
22407	Blade 22
22408	Blade 23
22409	Blade 24

Multilingual box: GB, FR, IT, ES, DE, DK, NL, GR, PT, PL, FI, RU, NO, SE

GIMA code	CARBON STEEL STITCH CUTTER BLADE - STERILE	Minimum order
22420	Carbon steel stitch cutter blade	box of 100



GIMA code	SWANN-MORTON S/S HANDLES	Compatibility with blade No.
22425	Graduated S/S n° 3 handle	10, 11, 12, 15
22426	Graduated S/S n° 4 handle	20, 21, 22, 23, 24

## PARAGON BLADES AND SCALPELS

### "PARAGON" DISPOSABLE S/S BLADES - sterile

High quality blades manufactured with best British stainless steel guarantee excellent sharpening and perfect cut control. Individually packed in metal foil. Gamma rays sterilized.



### "PARAGON" DISPOSABLE SCALPELS WITH S/S BLADE - sterile

Grip on the plastic handle allows stability for long straight incisions. Individually packed in sterilized envelope, reinforced with blade protection, in cardboard box of 10 units.



Blades box of 100	Scalpels box of 10	STERILE, S/S BLADE
26901	26920	Blade 10
26902	26921	Blade 11
26903	26922	Blade 12
26904	26923	Blade 15T
26905	26924	Blade 20
26906	26925	Blade 21
26907	26926	Blade 22
26908	26927	Blade 23
26909	26928	Blade 24

Multilingual box: GB, FR, IT, ES, DE, DK, NL, GR, PT, PL, FI, RU, NO, SE

## BLADE REMOVER

### • 22455 SURGICAL BLADE REMOVER - sterile - box of 50

The Swann-Morton Blade Remover allows for safe and easy removal of all sizes scalpel blade from both No.3 and No.4 handles assisting in the reduction of accidental sharps injuries.



Swann-Morton®

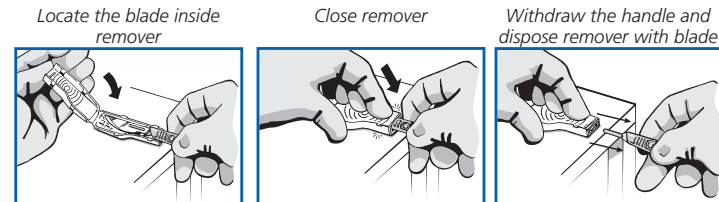

## SAFETY HANDLE

### • 26915 SAFETY S/S HANDLE N 3 for blades 10-15 • 26916 SAFETY S/S HANDLE N 4 for blades 20-25

Innovative handle allows hand-free removal of blade in compliance with OSHA and CDC.

SHARP INJURY PREVENTION WITH SAFETY HANDLE AND BLADES



Safety handle N°3 for safety blades N°10-15

## GIMA SINGLE-USE STERILE DERMAL CURETTES - LATEX FREE

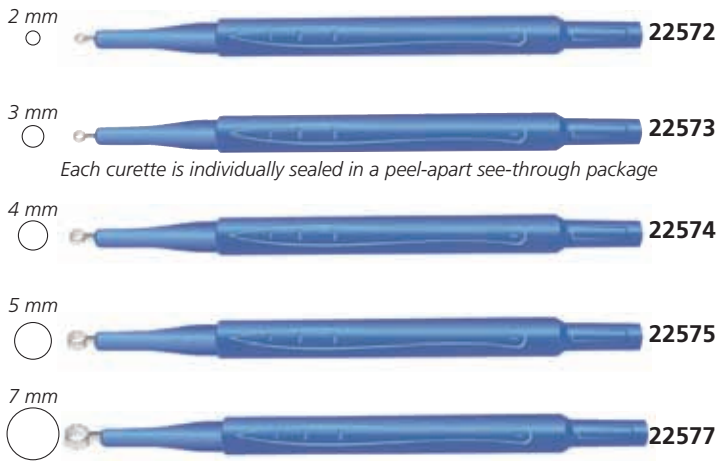

Sterile, ready-to-use, disposable curettes eliminate need for re-sharpening and sterilization. Seamless, stainless steel sharp cutting edge. Easy dynamic gripping handle for sure grip. Size embossed on each curette for easy identification.

Wide range of sizes.

**Clinical Areas:** dermatology, surgical, podiatry, oncology, veterinary.

Multilingual box and instructions: GB, FR, IT, ES, PT, DE, PL, GR, RU, FI, SE, NL, RO, BG, HR, HU, NO, Arabic.



22574

GIMA code	DERMAL CURETTES - STERILE	Minimum order
22572	Dermal curettes Ø 2 mm	box of 10
22573	Dermal curettes Ø 3 mm	box of 10
22574	Dermal curettes Ø 4 mm	box of 10
22575	Dermal curettes Ø 5 mm	box of 10
22577	Dermal curettes Ø 7 mm	box of 10

## GIMA SINGLE-USE STERILE DERMAL CURETTES WITH SCRAPER

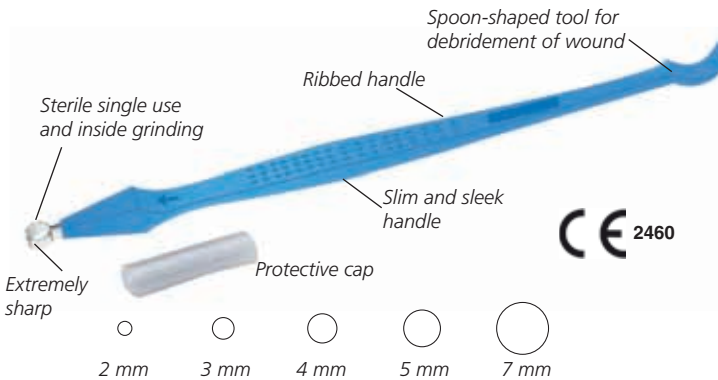

New dermal curette recommended by dermatologists, for skin and wound care. Each curette is individually sealed in a peel-apart see-through package.

**Clinical Areas:** dermatology, surgical, podiatry, oncology, veterinary.

Multilingual box and instructions: GB, FR, IT, ES, PT, DE, PL, GR, RU, FI, SE, NL, RO, BG, HR, HU, NO, Arabic.

GIMA code	DERMAL CURETTES WITH SCRAPER - STERILE	Minimum order
22562	Dermal curettes with scraper Ø 2 mm	box of 10
22563	Dermal curettes with scraper Ø 3 mm	box of 10
22564	Dermal curettes with scraper Ø 4 mm	box of 10
22565	Dermal curettes with scraper Ø 5 mm	box of 10
22567	Dermal curettes with scraper Ø 7 mm	box of 10

## GIMA SINGLE-USE, STERILE BIOPSY PUNCHES - LATEX FREE

Sterile, ready-to-use, disposable punches eliminate need for sterilization. Seamless, stainless steel sharp cutting edge, ribbed handle for sure grip and control. Size embossed on each punch for easy identification. Wide range of sizes. Each punch is individually sealed in a peel-apart see-through package.

**Clinical areas:** dermatology, gynaecology, podiatry. Multilingual box and instructions: GB, FR, IT, ES, PT, DE, PL, GR, RU, FI, SE, NL, RO, BG, HR, HU, NO, Arabic.



22590

GIMA code	BIOPSY PUNCHES - STERILE	Blade length mm	Minimum order
22580	Biopsy Punches Ø 1 mm	8	box of 10
22581	Biopsy Punches Ø 1.5 mm	8	box of 10
22582	Biopsy Punches Ø 2 mm	8	box of 10
22583	Biopsy Punches Ø 2.5 mm	8	box of 10
22584	Biopsy Punches Ø 3 mm	8	box of 10
22585	Biopsy Punches Ø 3.5 mm	8	box of 10
22586	Biopsy Punches Ø 4 mm	8	box of 10
22587	Biopsy Punches Ø 5 mm	8	box of 10
22588	Biopsy Punches Ø 6 mm	8	box of 10
22589	Biopsy Punches Ø 7 mm	8	box of 10
22590	Biopsy Punches Ø 8 mm	8	box of 10

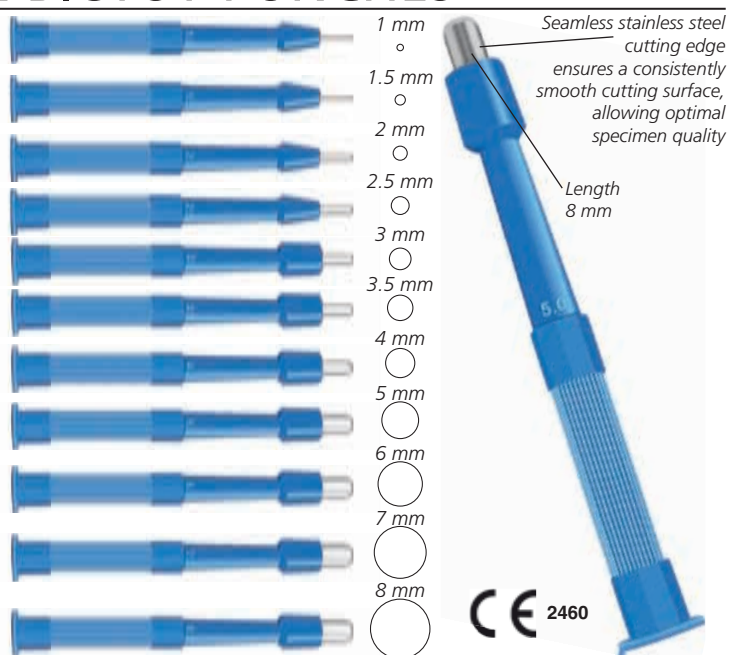

## DOUBLE CURETTE - EXTRACTOR

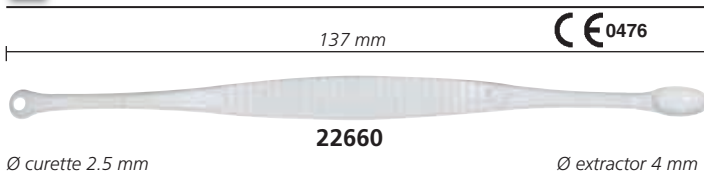

22660

Ø curette 2.5 mm

Ø extractor 4 mm

• 22660 CURMEDON DOUBLE CURETTE BESNIER TYPE AND EXTRACTOR - sterile - box of 20

Medical device for skin care procedure in Dermatology.

Sterilization: Ethylene Oxide.

Each curette is individually packed in a pouch.

Latex and PVC free.

# STIEFEL DERMAL CURETTES AND BIOPSY PUNCHES

Ready for use, sterile, individually packed. Extremely sharp stainless steel half edge for soft tissue. Ergonomic handle for a better grip.



Size engraved on each curette for easy identification.

GIMA code	STIEFEL code	DERMAL CURETTES - STERILE	Minimum order
22642	STIEF-CUR4	Dermal curettes Ø 4 mm	box of 10
22644	STIEF-CUR7	Dermal curettes Ø 7 mm	box of 10

Disposable sterile instrument to perform an accurate skin biopsy. Stainless steel seamless sharp edge. Ribbed handle for more precise grip.



Size engraved on each punch for easy identification.

GIMA code	STIEFEL code	BIOPSY PUNCHES - STERILE	Minimum order
22650	STIEF-BP2	Biopsy punches Ø 2 mm	box of 10
22651	STIEF-BP3	Biopsy punches Ø 3 mm	box of 10
22652	STIEF-BP35	Biopsy punches Ø 3.5 mm	box of 10
22653	STIEF-BP4	Biopsy punches Ø 4 mm	box of 10
22654	STIEF-BP5	Biopsy punches Ø 5 mm	box of 10
22655	STIEF-BP6	Biopsy punches Ø 6 mm	box of 10
22656	STIEF-BP8	Biopsy punches Ø 8 mm	box of 10

## SINGLE-USE STERILE DERMAL CURETTES



Stainless steel sharp cutting edge for soft or weak tissue. Size embossed on each curette for easy identification. Sterile ready-to-use. Use once and discard eliminates need for re-sharpening and sterilization. Wide range of sizes.

**Used in the following minor surgical skin procedures:** Curettage of basal cell carcinoma, verruca and any other benign neoplasms of the skin.

**Clinical Areas:** dermatology, surgical, podiatry, veterinary.

MADE IN JAPAN

GIMA code	DERMAL CURETTES	Minimum order
22602	Dermal Curettes Ø 2 mm	box of 20
22603	Dermal Curettes Ø 3 mm	box of 20
22604	Dermal Curettes Ø 4 mm	box of 20
22605	Dermal Curettes Ø 5 mm	box of 20
22606	Dermal Curettes Ø 7 mm	box of 20



LATEX FREE

## SINGLE-USE STERILE BIOPSY PUNCHES - LATEX FREE

Stainless steel sharp cutting edge, ribbed handle for sure grip. Size embossed on each punch for easy identification. Suggested for dermatology, gynaecology, podiatry. Each punch is individually sealed in a peel-apart see-through package.

Standard	With plunger	BIOPSY PUNCHES	Blade length mm	Minimum order
22610	22630	Biopsy Punches Ø 1 mm	7	box of 20
22611	22631	Biopsy Punches Ø 1.5 mm	7	box of 20
22612	22632	Biopsy Punches Ø 2 mm	7	box of 20
22613	-	Biopsy Punches Ø 2.5 mm	7	box of 20
22614	22634	Biopsy Punches Ø 3 mm	7	box of 20
22615	-	Biopsy Punches Ø 3.5 mm	7	box of 20
22616	22636	Biopsy Punches Ø 4 mm	7	box of 20
22617	-	Biopsy Punches Ø 5 mm	7	box of 20
22618	-	Biopsy Punches Ø 6 mm	7	box of 20
22619	-	Biopsy Punches Ø 8 mm	7	box of 20



Seamless stainless steel cutting edge ensures a consistently smooth cutting surface, allowing optimal specimen quality



CE 0197

MADE IN JAPAN



**Internal Plunger System**  
Ejects lodged skin specimen inside the metal lumen of the punch



Punches are individually packed in a transparent, sturdy, blister in a 20 punches multilingual dispenser (GB, FR, DE, ES, PT, JP)



## URINE CONTAINERS



Graduated urine containers made of polypropylene with red screw cap and frosted label.  
One multilingual instruction in each carton: GB, FR, IT, ES, PT.

GIMA code	URINE CONTAINERS - BULK	Minimum order
25958	Urine containers 120 ml	box of 300
URINE CONTAINERS - individually wrapped		
25960	Urine containers 60 ml - cleanroom ISO8	box of 500
25961	Urine containers 60 ml - sterile	box of 500
25962	Urine containers 120 ml - cleanroom ISO8	box of 250
25963	Urine containers 120 ml - sterile	box of 250

## PLASTIC BED PAN - URINAL



- **25979 PLASTIC BED PAN - box of 20**  
Made of polypropylene and individually wrapped.
  - **25978 MEN PLASTIC URINAL 1,000 ml - box of 60**  
Made of polyethylene and individually wrapped.
- Bed pan and plastic urinal have multilingual polybag: GB, FR, IT, ES, PT, PL, GR, SE.

## BIOLOGICAL COLLECTORS

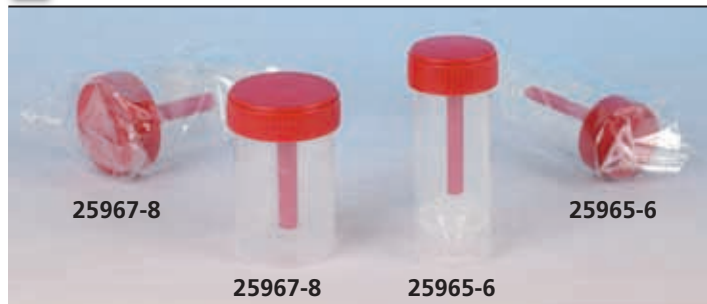

Coprotainer® graduated faeces containers made of polypropylene with red screw cap and frosted label, individually wrapped.  
One multilingual instruction in each carton: GB, FR, IT, ES, PT.

GIMA code	BIOLOGICAL CONTAINERS	Minimum order
25965	Faeces container 30 ml - cleanroom ISO8	box of 500
25966	Faeces container 30 ml - sterile	box of 500
25967	Faeces container 60 ml - cleanroom ISO8	box of 500
25968	Faeces container 60 ml - sterile	box of 500

## 24 HOURS URINE CONTAINERS



24 h graduated urine containers made of polyethylene.  
One multilingual instruction in each carton: GB, FR, IT, ES, PT.

GIMA code	24 h URINE CONTAINERS	Minimum order
25980	Bottle 2500 ml	box of 30
25981	Container 2000 ml with ergonomic handle	box of 54
25982	Tank 2500 ml	box of 30
25984	Tank 3000 ml with aspiration system for vacuum tubes and ergonomic handle	box of 30

## CONTAINERS IN SINGLE BOX - PHARMACY LINE



**Graduated, sterile urine and faeces containers**  
Individually wrapped sterile containers with paper label (25987) or frosted label (25969, 25997) and screw cap in single box.

**Graduated 24 h urine tank**  
Polyethylene urine tank for 24 hour urine collection, in single box

**Sterile urine test tube and vacuum tube**  
Individually wrapped urine test tube with paper label in single box. Graduated 0.5, 1, 2.5, 5, 10 ml.  
All products have multilingual box: GB, FR, IT, ES.

GIMA code	CONTAINERS	Material	Minimum order
25987	Urine container 120 ml - red cap	Polypropylene	box of 100
25969	Urine container 120 ml - yellow cap	Polypropylene	box of 100
25975	Urine vacuum tube 10 ml	Polypropylene	box of 100
25990	Urine test tube 12 ml	Polystyrene	box of 100
25995	Urine tank 24 h 2500 ml	Polyethylene	box of 27
25997	Faeces container 60 ml	Polypropylene	box of 100

## PLASTIC HOLLOWARE - AUTOCLAVABLE 135°C



**PLASTIC HOLLOWARE - autoclavable hundreds of times**  
 For the protection and delivery of sterile instruments to operating rooms. For the administration of procedures, holding cleansing solutions and the administration of medicines and fluids.

**4 good reasons to choose plastic line:**

- 50% cheaper than stainless steel
- autoclavable at 135°C with no limits
- attractive modern design
- lighter than equivalent stainless steel

Made of polypropylene material, easy to clean, resistant to most healthcare chemicals.

- 26630 GALLIPOT/LOTION BOWL 60xh 40 mm - graduated 50 ml
- 26631 GALLIPOT/LOTION BOWL 80xh 60 mm - graduated 200 ml
- 26632 GALLIPOT/LOTION BOWL 100xh 70 mm - graduated 300 ml
- 26633 GALLIPOT/LOTION BOWL 150xh 70 mm - graduated 500 ml
- 26635 KIDNEY DISH 200xh 45 mm - graduated 500 ml
- 26636 KIDNEY DISH 250xh 55 mm - graduated 750 ml with special nodules on rim to prevent vacuum during autoclaving
- 26638 INSTRUMENT TRAY 200x150x51 mm
- 26639 INSTRUMENT TRAY 300x250x52 mm
- 26640 COMPARTMENT TRAY 270x180x41 mm



## VALUE PLASTIC HOLLOWARE - AUTOCLAVABLE 134°C

Economic line of reusable plasticware products.

Made of polypropylene, easy to clean and resistant to most

healthcare chemicals. Autoclavable at 121°C (15 min), 126°C (10 min) or 134°C (3 min).



- 37701 GALLIPOT 63x42 mm - 90 ml
- 37702 GALLIPOT 90x60 mm - 240 ml



- 37705 KIDNEY TRAY 6" 155x75 mm
- 37706 KIDNEY TRAY 8" 205x100 mm
- 37707 KIDNEY TRAY 10" 260x125 mm
- 37708 KIDNEY TRAY 12" 306x140 mm



- 37710 MEASURING JUG 500 ml
  - 37711 MEASURING JUG 1,000 ml
  - 37712 MEASURING JUG 2,000 ml
- Raised graduation for easy reading.



- 37715 LABORATORY TRAY 375x300xh 75 mm



- 37717 COMPARTMENT TRAY 266x175xh 42 mm



- Provided with cover which fits into groove of the tray to avoid minimum spillage of material.
- 37718 INSTRUMENT TRAY 220x150xh 70 mm

## RECYCLED CELLULOSE PAPER HOLLOWARE - WATERPROOF

Single use urine and liquid containers, made of recycled cellulose paper, paper binders and adjuvants. Safe, clean, atoxic and latex free. Biocompatibility certificate in accordance with ISO 10993-10:2010. Containers can be subjected to ETO standard sterilization. Multilingual instruction and label: GB, FR, IT, ES, PT, DE, PL, RO, GR, SE.

Material:  
 Intended use:  
 Resistance:  
 Disposal:  
 Medical device:

**TECHNICAL SPECIFICATIONS**  
 moulded paper pulp  
 urine, blood, vomit  
 36 hours to water, 4 hours to organic liquids  
 biodegradable and compostable  
 93/42 CE - Class I non sterile

**MEDICAL USE**



- 26645 DISPOSABLE KIDNEY DISH 0.75 l - box of 300 pcs  
 Size: 25.2x15x4.6 cm



- 37680 DISPOSABLE BASIN 3l - box of 100 pcs  
 Size: 29.9x25.4x10.2 cm



- 37681 DISPOSABLE GRADUATED JUG 1.5 l - box of 150 pcs  
 Size: 23.9x16.7x11.6 cm



- 37682 DISPOSABLE MALE PORTABLE URINAL 0.9 l - box of 100 pcs  
 Size: 26x11.5x11 cm

**S/S KIDNEY DISHES - AUTOCLAVABLE 121°C**

*Kidney dishes have curved edges*



**ECONOMIC S/S KIDNEY DISHES**

S/S Kidney dishes, autoclavable 121°C, with 0.5 mm thickness

GIMA code	ECONOMIC S/S KIDNEY DISHES	Capacity
26641	Tray 6" - 162x77x31 mm	190 ml
26642	Tray 8" - 207x98x39 mm	400 ml
26643	Tray 10" - 247x122x43 mm	600 ml
26644	Tray 12" - 309x149x59 mm	1500 ml

**BUCKETS WITH LID - STAINLESS STEEL**

- 26574 COMMODE BUCKET WITH LID 5 l  
- Ø 307xh 167 mm
  - 26576 BUCKET WITH LID 12 l  
- Ø 290xh 300 mm
  - 26577 BUCKET WITH LID 15 l  
- Ø 322xh 307 mm
- Stainless Steel AISI 304 buckets autoclavable at 121°C.



**S/S AISI 304 - 18/8 KIDNEY DISHES - THICKNESS 0.6 MM - AUTOCLAVABLE 121°C**



GIMA code	SHALLOW KIDNEY DISHES	Capacity
26610	Tray 8" - 207x128xh 33 mm	480 ml
26611	Tray 10" - 254x141xh 33 mm	750 ml
26612	Tray 12" - 280x141xh 40 mm	1600 ml



GIMA code	DEEP KIDNEY DISHES	Capacity
26580	Tray 6" - 162x77x31 mm	190 ml
26581	Tray 8" - 207x98x39 mm	400 ml
26582	Tray 10" - 247x122x43 mm	600 ml
26583	Tray 12" - 309x149x59 mm	1500 ml



GIMA code	DEEP WITH COVER* KIDNEY DISHES	Capacity
26584	Tray 7" - 200x95x35 mm	300 ml
26585	Tray 10" - 247x122x43 mm	600 ml
26589	Tray 12" - 309x149x59 mm	1500 ml

\*Thickness of cover 0.5 mm

**S/S AISI 304 - 18/8 WASH BASINS AND GALLIPOTS - AUTOCLAVABLE 121°C**



GIMA code	SHALLOW KIDNEY DISHES	Capacity
26586	Ø 310x h 72 mm - shallow	3 l
26588	Ø 405x h 95 mm - shallow	7 l
26587	Ø 318x h 84 mm - deep	4 l



GIMA code	ROUND GALLIPOTS	Capacity
26595	Ø 107xh 56 mm	325 ml
26596	Ø 158xh 75 mm	940 ml
26621	Ø 208xh 84 mm	1940 ml
26622	Ø 258xh 92 mm	3200 ml



GIMA code	GALLIPOTS WITH LIP	Capacity
26616	Ø 56xh 32 mm	50 ml
26617	Ø 88xh 46 mm	170 ml
26618	Ø 128xh 60 mm	450 ml
26619	Ø 158xh 75 mm	940 ml



**STAINLESS STEEL HOLLOWARE - AUTOCLAVABLE 121°C - AISI 304**

26603

26607

**STAINLESS STEEL HOLLOWARE**  
Stainless steel AISI 304 holloware with minimum thickness 0.6 mm.



GIMA code	INSTRUMENT TRAYS - ANGLED EDGES
Without cover	
26603	306x196x h 50 mm
26604	355x254x h 50 mm
26597	380x304x h 50 mm
26598	440x320x h 64 mm
With cover	
26607	306x196x h 50 mm
26608	355x254x h 50 mm
26609	440x320x h 64 mm
Perforated with cover	
26646	223x126x h 45 mm
26647	355x254x h 50 mm

26598

26608

*Supplied with cover*



26605

26602

26600

26601

26651

GIMA code	INSTRUMENT TRAYS ROUND EDGES
Without cover	
26599	223x126x h 45 mm
26602	264x172x h 47 mm
With cover	
26605	223x126x h 45 mm
26606	264x172x h 47 mm

GIMA code	DENTAL TRAY
26600	208x109x h 15 mm
INSTRUMENT TRAYS	
26601	210x160x h 25 mm
26629	313x218x h 31 mm

GIMA code	MAYO TRAYS - SHALLOW
Non perforated	
26613	254x165x h 18 mm
26614	350x252x h 16 mm
26615	432x295x h 19 mm
Perforated	
26651	350x252x h 16 mm



26573

- 26573 ROUND BED PAN WITH COVER - straight handle - Ø 300xh 85 mm



- 26623 DRESSING JAR - 0.5 l - Ø 102x65 mm
- 26624 DRESSING JAR - 1 l - Ø 103x126 mm
- 26625 DRESSING JAR - 2 l - Ø 127x161 mm



- 26626 FORCEPS JAR - Ø 55xh 140 mm
- 26627 FORCEPS JAR - Ø 55xh 180 mm
- 26628 THERMOMETER JAR - Ø 33xh 80 mm
- 26620 MEDICINE CUP - 60 ml - Ø 53xh 53 mm



26590

- 26590 BED PAN FRACTURE TYPE - with ring - 418x292x85 mm



26594

- 26594 BED PAN FRACTURE TYPE - with tube handle - 418x292x85 mm



26593

- 26593 BED PAN PERFECTION TYPE 354x289x97 mm



26578

- 26578 MALE URINAL - 1.2 l



26579

- 26579 FEMALE URINAL - 1.2 l



26591

- 26591 MALE VERTICAL URINAL Ø 114x220 mm - 1.5 l

# HYPODERMIC SYRINGES IN 3 PARTS WITH AND WITHOUT NEEDLE

High-quality range of medical devices ensuring an optimal safety. The range of Hypodermic syringe INJ/LIGHT have been manufactured in compliance with the most important international standards in conformity with European Directive 93/42/EEC and with UNI EN ISO 9001/2015 - UNI EN ISO 13485/2016.

The INJ/LIGHT line is completely non-toxic and non-pyrogenic, made of transparent polypropylene with graduated black colour scale and individually packed in blister pack. Needles in AISI 304 stainless steel triple bevelling. Box in GB, FR, IT, ES, DE, PT, GR, RO, RU, YU, SA.

## SYRINGE WITHOUT NEEDLE

GIMA code	Capacity	Minimum order
<b>LUER LOCK CONE</b>		
23806	1 ml	box of 100
23807	5 ml	box of 100
23808	10 ml	box of 100
23809	20 ml	box of 50
23810	30 ml	box of 50
23811	60 ml	box of 25
<b>CENTRIC LUER CONE</b>		
23813	3 ml	box of 100
23814	5 ml	box of 100
23815	10 ml	box of 100
23812	20 ml	box of 50
<b>ECCENTRIC LUER CONE</b>		
23816	10 ml	box of 100
23817	20 ml	box of 50
23819	60 ml	box of 25
<b>CATHETER LUER CONE</b>		
23820	60 ml	box of 20
23821	100 ml	box of 25

## SYRINGE WITH NEEDLE

GIMA code	Capacity	Assembled needle	Minimum order
<b>CENTRIC LUER CONE</b>			
23822	1 ml - tuberculin	26G - 0.45x13 mm	box of 100
23824	2.5 ml	21G - 0.8x38 mm	box of 100
23825	2.5 ml	22G - 0.7x32 mm	box of 100
23827	5 ml	21G - 0.8x38 mm	box of 100
23828	5 ml	22G - 0.7x32 mm	box of 100
23830	10 ml	21G - 0.8x38 mm	box of 100
23831	10 ml	22G - 0.7x32 mm	box of 100
23832	20 ml	21G - 0.8x38 mm	box of 50

## SYRINGE WITH SAFETY NEEDLE

GIMA code	Capacity	Assembled needle	Minimum order
<b>CENTRIC LUER CONE</b>			
23835	2.5 ml	22G - 0.7x32 mm	box of 100
23836	5 ml	22G - 0.7x32 mm	box of 100
23837	10 ml	21G - 0.8x38 mm	box of 50
23838	10 ml	22G - 0.7x32 mm	box of 50

**STOP ACCIDENTAL NEEDLE STICKS**

## ECCENTRIC LUER CONE WITH NEEDLE

23833	10 ml	21G - 0.8x38 mm	box of 100
23834	20 ml	21G - 0.8x38 mm	box of 50



Medical Device class IIa

# HYPODERMIC NEEDLES AND SCALP-VEIN SETS - STERILE

A line of hypodermic needles and scalp vein sets ensuring minimal trauma during penetration thanks to the triple bevelling. Each element of the needle is treated for painless injection. Needles are in stainless steel AISI 304 and totally non-toxic and non-pyrogenic.

Needles have Luer-slip cone, can be mounted on syringes with Luer-slip or Luer-lock. The scalp vein set needles are provided with soft flexible grained wings. The tube is made of 30 cm PVC with luer-lock. Individually packaged in blister. Box and instructions: GB, FR, IT, DE, ES, PT, GR, RU (Scalp-vein sets), GB, IT, ES, PT (Hypodermic needles).



HYPODERMIC NEEDLES				
Standard	Safety	Needle	Colour	Minimum order
23750	23790	18G - 1.2x38 mm	● Pink	box of 100
23751	23791	19G - 1.1x38 mm	● Cream	box of 100
23753	-	20G - 0.9x38 mm	● Yellow	box of 100
23755	23793	21G - 0.8x38 mm	● Green	box of 100
23757	-	22G - 0.7x32 mm	● Black	box of 100
23758	23794	23G - 0.6x25 mm	● Turquoise	box of 100
23760	-	25G - 0.5x16 mm	● Orange	box of 100
23761	-	26G - 0.45x13 mm	● Brown	box of 100
23762	-	27G - 0.4x13 mm	● Grey	box of 100

SCALP - VEIN SETS				
Standard	Safety	Needle	Colour	Minimum order
23766	-	19G - 1.1x19 mm	● Cream	box of 100
23767	-	20G - 0.9x19 mm	● Yellow	box of 100
23768	23774	21G - 0.8x19 mm	● Green	box of 100
23769	-	22G - 0.7x19 mm	● Black	box of 100
23770	23776	23G - 0.6x19 mm	● Turquoise	box of 100
23771	-	25G - 0.5x19 mm	● Orange	box of 100



Medical Device

## TERUMO® AGANI™ HYPODERMIC NEEDLES - STERILE

Sterile hypodermic needles for single use, suitable for a wide range of applications.

Special geometry of the sharp lancet point facilitates the penetration of the skin and helps to minimize the trauma. Silicone-coated cannula provides good gliding properties for a smooth penetration and prevents any knocking effect.



Secure and easy handling increases safety and user comfort: the steeper point angle of the short bevel shortens the length of the needle bevel, reducing the risk of vascular perforation. Hub made of polypropylene, needle made of stainless steel. ISO colour-coded hub allows to recognize the diameter of the needle. Class IIa. MDR 2017/745. Shelf life at production: 5 years. Individually packed in blister. Multilingual box: GB, FR, IT, ES, PT, DE, PL, NL, HU, GR, BG, RO, FI, NO, SE, DK, CZ, SK, SI, RS, EE, LV, LT, TR, RU.



AGANI™ HYPODERMIC NEEDLES				
GIMA Code	TERUMO® Code	Needle	Colour	Minimum order
37600	AN*1838R1	18Gx1 1/2" - 1.2x38 mm	pink	box of 100
37605	AN*2138R1	21Gx1 1/2" - 0.8x38 mm	green	box of 100
37607	AN*2232R1	22Gx1 1/4" - 0.7x32 mm	black	box of 100
37609	AN*2325R1	23Gx1" - 0.6x25 mm	blue	box of 100
37610	AN*2332R1	23Gx1 1/4" - 0.6 x 32 mm	blue	box of 100
37611	AN*2425R1	24Gx1" - 0.55 x 25 mm	purple	box of 100
37612	AN*2516R1	25Gx5/8" - 0.5 x 16 mm	orange	box of 100
37613	AN*2525R1	25Gx1" - 0.5 x 25 mm	orange	box of 100
37616	AN*2719R1	27Gx3/4" - 0.4 x 19 mm	grey	box of 100
37617	AN*3013R1	30Gx1/2" - 0.3 x 13 mm	yellow	box of 100



## TERUMO® 3 PART SYRINGES WITH AND WITHOUT NEEDLE

Sterile 3-part syringes for single use, with or without pre-connected sterile hypodermic needle. Syringes are intended for the aspiration of fluid or blood, or for the injection of fluids immediately after filling into the human body. Hub is made of polypropylene and master batch, while cannula is made of stainless steel. Latex free.

Transparent barrel provides easy recognition of air bubbles

and the clear printing allows for precise dosage management. Class IIa, Medical Device following MDR 2017/745.

Shelf life at production: 5 years. Multilingual box: GB, FR, IT, ES, PT, DE, PL, NL, HU, GR, BG, RO, FI, NO, SE, DK, CZ, SK, SI, RS, EE, LV, LT, TR, RU.



TERUMO® SYRINGES WITHOUT NEEDLE - STERILE				
GIMA code	TERUMO® Code	Capacity	Minimum order	
<b>CONCENTRIC LUER LOCK</b>				
37630	SS+03L1	3 ml	box of 100	
37632	SS+05LE1	5 ml	box of 100	
37634	SS+10LE1	10 ml	box of 100	
37635	SS+20L1	20 ml	box of 50	
37637	SS+30L1MP	30 ml	box of 25	
37638	SS+50L1	50 ml - transparent Polypropylene barrel	box of 25	
<b>CONCENTRIC LUER SLIP</b>				
37640	MDSS01SE	1 ml - Tuberculin	box of 100	
37641	MDSS03SE	3 ml	box of 100	
37643	MDSS05SE	5 ml	box of 100	
<b>ECCENTRIC LUER SLIP</b>				
37645	MDSS10ESE	10 ml	box of 100	
37646	MDSS20ESE	20 ml	box of 50	
<b>CATHETER TIP</b>				
37648	SS+50C1	50 ml	box of 25	

TERUMO® SYRINGES WITH NEEDLE - STERILE				
GIMA code	TERUMO® Code	Capacity	Assembled needle	Minimum order
37652	SS*02SE21381	2.5 ml	21Gx1 1/2" - 0.8x40 mm	box of 100
37653	SS*02SE22381	2.5 ml	22Gx1 1/2" - 0.7x38mm	box of 100
37655	MDSS05S2238E	5 ml	21Gx1 1/2" - 0.8x38mm	box of 100
37656	MDSS05S2332E	5 ml	22Gx1 1/2" - 0.7x38mm	box of 100
37659	MDSS10S2138E	10 ml	21Gx1 1/2" - 0.8x38mm	box of 100
<b>TUBERCULIN</b>				
37662	MDSS01S2613E	1 ml	26Gx1/2" - 0.45x13mm	box of 100
<b>TUBERCULIN LUER</b>				
37664	MDSS01S2516E	1 ml	25Gx5/8" - 0.5x16mm	box of 100



## INTRAMUSCULAR INJECTION TRAINING PAD

• 23797 INTRAMUSCULAR INJECTION TRAINING WEARABLE PAD - with strap  
Intramuscular injection training pad, with strap for fixation around body limbs, to perform injection exercises. To increase realism of operation, the module is divided into skin, muscle layer and outer frame card structure. Surface is made of silicone with internal sponge, base is made of plastic.



## BD EMERALD™ SYRINGES

*Minimizes Waste Disposal*  
Has up to 30% less material than other syringes

*Flange Size and Shape*  
To provide stability and comfort during use

*Textured Thumb Press*  
To reduce slippage during administration

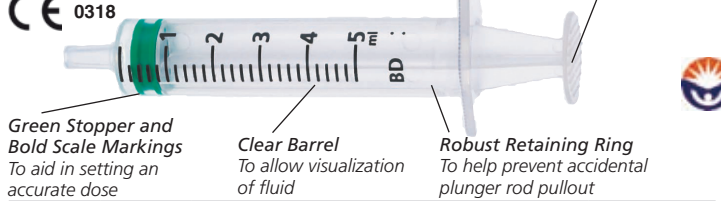

BD EMERALD™ SYRINGES				
GIMA code	BD code	Capacity	NEEDLE	Minimum order
<b>SYRINGES WITHOUT NEEDLES - LUER SLIP CENTRIC TIP</b>				
23863	307727	2 ml		box of 100
23864	307731	5 ml		box of 100
23865	307736	10 ml		box of 100
<b>SYRINGES WITH NEEDLES - LUER SLIP CENTRIC TIP</b>				
23868	307728	2 ml	22G - 0.7x30 mm	box of 100
23869	307733	5 ml	22G - 0.7x30 mm	box of 100
23870	307737	10 ml	21G - 0.8x40 mm	box of 100

## BD PLASTIPAK™ SYRINGES



BD PLASTIPAK™ SYRINGES				
GIMA code	BD code	Capacity	MODEL	Minimum order
<b>SYRINGES WITHOUT NEEDLE - LUER LOCK</b>				
23873	301229	30 ml	Luer - lock	box of 60
23874	300865	50 ml	Luer - lock	box of 60
<b>SYRINGES WITHOUT NEEDLE - CATHETER CONE</b>				
23877	300867	50 ml	Catheter cone	box of 60
23878	300605	100 ml	Catheter cone	box of 25

## BD MICROLANCE™ NEEDLES

GIMA code	BD code	BD MICROLANCE™ NEEDLES	Minimum order
23739	304622	18G - 1.20x40 mm - pink	box of 100
23740	301500	19G - 1.10x40 mm - white	box of 100
23741	301300	20G - 0.90x40 mm - yellow	box of 100
23742	304432	21G - 0.80x40 mm - green	box of 100
23743	300900	22G - 0.70x30 mm - black	box of 100
23744	300800	23G - 0.60x25 mm - blue	box of 100
23745	300600	25G - 0.50x16 mm - orange	box of 100
23746	303800	26G - 0.45x13 mm - brown	box of 100
23747	300635	27G - 0.40x13 mm - grey	box of 100
23748	304000	30G - 0.29x13 mm - yellow	box of 100



## BD MICRO-FINE™ INSULIN NEEDLES AND SYRINGES

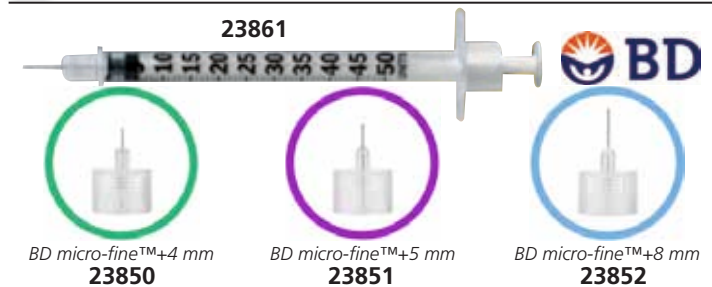

GIMA code	BD code	BD MICRO-FINE™ NEEDLES	Minimum order
23850	320140	BD Micro-Fine needles 4 mm - 32G	box of 100
23851	320594	BD Micro-Fine needles 5 mm - 31G	box of 100
23852	320592	BD Micro-Fine needles 8 mm - 31G	box of 100
<i>Compatible with most of insuline pens available on the market (Sanofi-Aventis, Eli Lilly, Novo Nordisk, Owen Mumford)</i>			
<b>BD MICRO-FINE™ SYRINGES</b>			
23860	324826	BD Micro-Fine syringes 0.3 ml - 8 mm - 30G	box of 100
23861	324825	BD Micro-Fine syringes 0.5 ml - 8 mm - 30G	box of 100

## INSULIN SYRINGE INSU/LIGHT

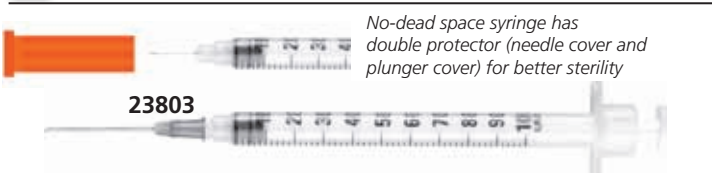

Available with assembled needle or fixed needle both with no-dead space. Insulin syringes with fixed needle have the needle directly fixed on the cone and have a double protection (needle cap and plunger cap), assuring the sterility of the device. Non-toxic and non-pyrogenic, made of transparent polypropylene with graduated insulin scale. Needle in stainless steel AISI 304 with triple bevelling.

GIMA code	INSULIN SYRINGE NO DEAD SPACE - ASSEMBLED NEEDLE	Minimum order
23802	Insulin syringe 1 ml - 25G - 0.5x16 mm	box of 100
23803	Insulin syringe 1 ml - 27G - 0.4x13 mm	box of 100
<b>INSULIN SYRINGE NO-DEAD SPACE - FIXED NEEDLE</b>		
23805	Insulin syringe 0.5 ml - 30G - 0.3x8 mm	box of 100

## INSULIN PEN NEEDLES



Insulin Pen Needles are disposable, sterile needles used with insulin pens to control high blood sugar in adults and children with diabetes mellitus. With a fine design to minimize the discomfort of injection, ultra-thin needles provide painless and a non traumatic injection due to a silicone film. Pyrogen free.

GIMA code	GIMA INSULIN PEN NEEDLES - UNIVERSAL	Minimum order
23840	GIMA insulin pen needles 4 mm - 32G	box of 100
23841	GIMA insulin pen needles 5 mm - 31G	box of 100
23842	GIMA insulin pen needles 6 mm - 31G	box of 100
23843	GIMA insulin pen needles 8 mm - 31G	box of 100
<i>Compatible with most of insulin pens available on the market (Sanofi-Aventis, Novo Nordisk, Eli Lilly, Owen Mumford)</i>		

# MESO-RELLE MESOTHERAPY, SCLEROTHERAPY, FILLER NEEDLES



## MESO-RELLE HYPODERMIC NEEDLES

Meso-relle disposable hypodermic needles are multiple sharpened to facilitate penetration. Stainless steel AISI 304 cannula and polypropylene connection for syringe. Sterilized with ethylene oxide. Sold in individual blister made of medical paper. **MADE IN JAPAN**

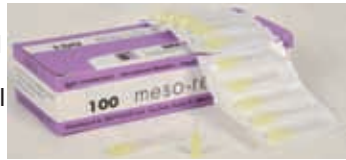

GIMA code	MESOTHERAPY LUER NEEDLES				Minimum order
	Gauge	Ø mm	Length mm	Colour	
23670	27G	0.40	4	grey	box of 100
23671	27G	0.40	6	grey	box of 100
23672	30G	0.30	4	yellow	box of 100
23673	30G	0.30	6	yellow	box of 100
23674	31G	0.26	4	light blue	box of 100
23675	31G	0.26	6	light blue	box of 100
23676	32G	0.23	4	pink	box of 100
23677	32G	0.23	6	pink	box of 100
23678	33G	0.20	4	green	box of 100
SCLEROTHERAPY/FILLER LUER NEEDLES					
23679	27G	0.40	12	grey	box of 100
23680	30G	0.30	12	yellow	box of 100
23682	31G	0.26	12	light blue	box of 100
23684	32G	0.23	12	pink	box of 100
FILLER LUER NEEDLES					
23686	27G	0.40	40	grey	box of 100
23687	30G	0.30	25	yellow	box of 100
23688	30G	0.30	40	yellow	box of 100

## MICRO-MESOTHERAPY



## MESO-RELLE MICRO-MESOTHERAPY

Microtherapy, an evolution of mesotherapy, is a recent technique for administration of drugs via superficial intraderma injection, improving intramuscular intra-venereal and subcutaneous injection technique.



Single use device with reversed cone shape and special ultrafine needle in its centre

GIMA code	MICRO-MESOTHERAPY NEEDLES - STERILE					Minimum order
	Type	Gauge	Ø mm	Length mm	Colour	
23690	Needle	27G		2.5	white	box of 25
23691	Needle	30G		2.5	yellow	box of 25
23694	S.I.T.*	31G	0.26	2.5	white	box of 25

\*Skin Injection Therapy

## MESO-RELLE MULTI-INJECTORS



## MESO-RELLE MULTI-INJECTOR CONNECTORS

Disposable mesotherapy multi-injectors connectors sterilized with ethylene oxide. Packed in individual, transparent blister, colourless and transparent to enable full examination of the inner chamber. Perfectly resistant to high pressure.

GIMA code	MULTI-INJECTOR CONNECTORS			Minimum order
	Type	Way-out	Taper	
23700	Straight	3	Luer	box of 50
23701	Straight	5	Luer	box of 50
23703	Circular	5	Luer	box of 50

## I.V. CATHETERS WITH STRAIGHT HUB OR SIDE PORT - STERILE

**SAFETY STRAIGHT HUB CATHETER**

- High flow rate thin wall kink-resistant polyurethane and FEP radiopaque catheters
- Secure grip and intuitive handling ribbed housing and bevel-up indicator
- Needle-in-vein aspiration removable flash plug
- Easy vein entry ultrasharp V-point introducer needle reduces penetration force by 25 to 30%
- Patient comfort and secure fixation long hub for generous suturing or taping
- Flast visualization translucent flash chamber

**SAFETY SIDEPORT CATHETER**

- Hygienic sideport access
- Stabilization
- High flow rate
- Easy vein entry
- Secure fixation
- Intermittent therapies

Conventional no protection	Safety	I.V. CATHETER WITH STRAIGHT HUB			Minimum order
		Gauge	Gauge mm	Colour	
23720	23726	18G	45 mm (1¾")	Green	box of 50
23721		20G	32 mm (1¼")	Pink	box of 50
23722		22G	25 mm (1")	Blue	box of 50

Conventional no protection	Safety	I.V. CATHETER WITH SIDE PORT			Minimum order
		Gauge	Gauge mm	Colour	
23730	23736	18G	45 mm (1¾")	Green	box of 50
23731		20G	32 mm (1¼")	Pink	box of 50
23732		22G	25 mm (1")	Blue	box of 50

## BD VENFLON™ IV CATHETERS - STERILE

### BD VENFLON™ IV CATHETERS

I.V. Cannula Luer-Lock with a plug attached to the flow control plug. Designed to gain access to peripheral veins of the patient's blood system for rehydration, parenteral nutrition, medication delivery, blood transfusion, and monitoring purposes.

GIMA code	BD code	BD VENFLON™ I.V. CATHETERS				Minimum order
		Gauge	Gauge mm	Flow rate	Colour	
23715	391453	18G	45 mm (1¾")	80	Green	box of 50
23716	391452	20G	32 mm (1¼")	54	Pink	box of 50
23717	391451	22G	25 mm (1")	31	Blue	box of 50

Flash Back Function - During the insertion of the cannula, blood flow is visualized by blood flash back in the hub of the cannula



23716

Multilingual box and instructions



## INFUSION SET

### INFUSION SETS

Infusion set includes:  
 ABS spike with air vent,  
 6 cm PVC chamber, 150 cm  
 PVC tube, ABS roller,  
 ABS luer lock terminal  
 without needle, latex free injection site.  
 Sterilized by Ethylene oxide.

- 26062 Y INFUSION SET - polybag - box of 500 (20 bags of 25)
- 26069 HOSE INFUSION SET - polybag - box of 500
- 26064 HOSE INFUSION SET - blister - box of 360 (18 bags of 20)



## INFUSION SET FOR PUMP

- 26073 ARIES I.V. INFUSION SET - box of 150 (6 bags of 25)

Infusion set for the  
 administration of  
 solution into the  
 human body with  
 pump.  
 Tested with infusion pump  
 Ampall Argus 707 and Optima  
 PT.



## NEEDLE-LESS VALVE

- 26059 NEEDLE-LESS VALVE - sterile - box of 500

Device for I.V. infusion and/or withdrawal,  
 needle-less closed circuit.

For protection of vascular access and of  
 all infusion systems equipped with  
 male luer-lock standard connections.

This closed and self-sealing protection  
 system allows to infuse or inject fluid,  
 make withdrawals eliminating the risk  
 of accidental puncture to operators  
 and reducing the risk of contamination  
 to patients.

Medical Device Class I.



Latex free  
 PVC free

CE 0123

## BD SPINAL NEEDLES

Single use latex free sterile BD quincke  
 point spinal anesthesia needles.



CE 0318



GIMA code	BD code	BD QUINCKE POINT SPINAL ANESTHESIA NEEDLE - STERILE	Minimum order
23705	405248	18G 3.50 IN 1.2x90 mm - pink	box of 25
23707	405253	20G 3.50 IN 0.9x90 mm - yellow	box of 25
23709	405256	22G 3.50 IN 0.7x90 mm - black	box of 25
23710	405240	23G 3.50 IN 0.64x90 mm - turquoise	box of 25
23711	405257	25G 3.50 IN 0.5x90 mm - orange	box of 25

## MULTI-VENOUS IV TRAINING ARMS



26048

Length 72.4 cm Weight 1.7 kg



Laerdal  
 helping save lives

26049

Length 73.7 cm Weight 1.79 kg

- 26048 LAERDAL MALE MULTI-VENOUS IV TRAINING KIT
- 26049 LAERDAL FEMALE MULTI-VENOUS IV TRAINING KIT

Lifelike arm reproduction with multi-vein system  
 designed for peripheral intravenous therapy.  
 Kit includes: arm, replacement skin and multi  
 vein system, simulated blood, blood bag with  
 tubing and connector, clamp and hook, 5 syringes,  
 manikin lubricant, carry case and directions for use.

## POCKET SHARP CONTAINER

- 25780 POCKET SHARP CONTAINER 0.4 l - 12.3x6.2xh 16.5 cm - box of 70

Single use container for both sharp  
 and cutting waste disposal.  
 The permanent and inviolable  
 closure that prevents waste leakage  
 and the high container resistance  
 guarantee top quality and safety.  
 Equipped with a patented double  
 opening system, it can be used  
 by just one hand.

The double opening includes one side  
 with needles and insulin pen removal,  
 and the other side with a large  
 opening for entire syringe disposal.

Double opening system

Temporary closure

Definitive closure



25780

MADE IN ITALY

### FEATURES 25780, 25781

- Pocket size
- Ergonomic shape (25780)
- Practical opening system
- Needles removal
- Insulin pen removal device
- Maximum filling level
- Shock resistant
- Puncture resistant
- Sturdy handle
- Possible side fastening
- Autoclavable at 134°C for 18'
- No emission of any harmful gas during the incineration process

## DISPO SHARP CONTAINER

- 25781 DISPO SHARP CONTAINER 0.5 l - 8.3x h 15.1 cm - box of 187

Single use conical shape puncture  
 resistant container for the disposal  
 of sharp and cutting waste.

The permanent and inviolable closure  
 that prevents waste leakage and the  
 high container resistance guarantee  
 top quality and safety.

Temporary and permanent closures with  
 a wide opening for the disposal  
 of larger materials, and three indents for  
 the needles and insulin pen removal.



Easy lid opening



Temporary closure



Permanent closure  
 25781



## COMPARTMENT TRAY

- 37725 COMPARTMENT TRAY 35x24,5xh 4,4 cm - box of 24

Compartment tray suitable for  
 carrying small containers and  
 minor hospital waste.

Tray fits PBS containers 25790-91-92  
 and CS container 25782, see page 74.



MADE IN ITALY

37725  
 + 25790

## PRO SPIKE FOR USED NEEDLES

- 27149 PRO SPIKE CONTAINER

27149

Small disposable plastic container for the separate  
 collection of spiky and cutting wastes (needles,  
 scalpels) on the operation field. It has a clever lid  
 with a safe closing system and a clip for belts and  
 backpacks attachment.

It can be disposed of with the contents.

Size: 90x54x185 mm  
 Weight: 88 g



# GIMA SHARPS CONTAINERS

Full range of Sharps containers for the disposal of sharp or cutting waste. Equipped with temporary and definitive closure, certified hermetic seal, do not release any harmful emission during incineration.

The containers hold the UN mark for the transportation of dangerous materials.

- practical opening system
- temporary and permanent closure
- needles removal
- insulin pen removal device
- maximum filling level
- shock resistant
- puncture resistant
- easy to use

- easy to assemble
- excellent stability
- square or round shaped
- sturdy handle for easier transport
- customisable label for quantities
- autoclavable at 134°C for 18'
- no emission of any harmful gas during the incineration process

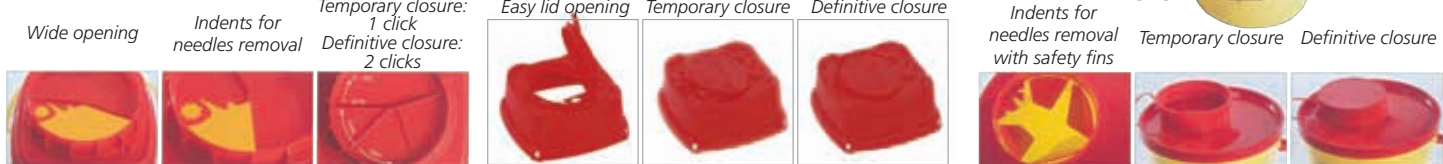

GIMA code	CS LINE SHARPS CONTAINERS	Minimum order	GIMA code	PBS SHARPS CONTAINERS	Minimum order
25782	CS 2 l - 14.8x14.8xh 19.5 cm	box of 60	25790	PBS 0.6 l - Ø 10xh 14.5 cm	box of 100
25783	CS 3 l - 16.7x16.7xh 23.2 cm	box of 50	25791	PBS 1.5 l - Ø 14xh 16.5 cm	box of 100
25784	CS 4 l - 16.7x16.7xh 28.2 cm	box of 40	25792	PBS 2 l - Ø 14xh 21 cm	box of 75
25785	CS 5 l - 21x21xh 20 cm	box of 30	25793	PBS 5 l - Ø 21.4xh 19.5 cm	box of 55
<b>CS PLUS LINE SHARPS CONTAINERS</b>			25796	PBS 6 l - Ø 21.4xh 24 cm	box of 55
25787	CS Plus 10 l - 22x22xh 32.5 cm	box of 33	25794	PBS 7 l - Ø 25xh 19.5 cm	box of 40
25788	CS Plus 22 l - 37.5x27.2xh 34.5 cm	box of 10	25795	PBS 12 l - Ø 25xh 31.3 cm	box of 25
25799	Fixing system* - horizontal or vertical		<b>TRAY FOR CONTAINERS</b>		
*Suitable for wall or trolley			37725	Compartment tray* 32x24.5xh 4.4 cm	box of 24

CERTIFICATIONS



\*Suitable for 25790-2, 25782

37725 + 25790

## WASTE CONTAINERS - 30-50-60 L

WASTE CONTAINERS - 3 sizes

Containers for disposal of special hospital waste in 3 sizes, with 2 different lids.

- extremely solid and shock resistant at high and low temperature
- hermetic seal by peripheral adhesive on the lid (single or double)
- lateral and central handles tested for twice the max weight
- stacking up to a maximum of 3 m with full load
- conformity: ISO 23907-1:2019

MADE IN ITALY



GIMA code	SC LINE WASTE CONTAINERS			
	Tide	Lid	Max load kg	Size
25774	Container 30 l	single	15	40x30xh 39 cm
25775	Container 30 l	double	15	40x30xh 39 cm
25776	Container 50 l	single	20	40x30xh 56 cm
25777	Container 50 l	double	20	40x30xh 56 cm
25778	Container 60 l	single	25	40x30xh 65 cm
25779	Container 60 l	double	25	40x30xh 65 cm



## CONTAINERS UP TO 72 CM

LONG SHARPS CONTAINERS

Disposable containers for the elimination of long objects up to 72 cm, such as biopsy forceps and sharps. Large opening, for elimination of bulky objects, temporary and definitive closure, ergonomic handle. Autoclavable at 134°C for 18'.

MADE IN ITALY



Tube not included

GIMA code	LONG SHARPS CONTAINERS
25797	Magnum L 6.3 l - 17.2x12xh 61.7 cm
25798	Magnum XL 8.3 l - 17.2x12xh 84.5 cm
25799	Fixing system* - horizontal or vertical

\*Suitable for wall or trolley

## VEINSPY™ HAND-HELD VEIN FINDER

### • 23450 VEINSPY™ HAND-HELD VEIN FINDER

**VeinSpy™** is a portable vein finder for easy visualisation of veins in adult, pediatric, geriatric, obese and dark skin patients with difficult venous access. It works on Transverse Illumination Technology: light beams from a circular LED array penetrate the skin and act as a light source to achieve deep illumination of subcutaneous tissues. The veins in the illuminated area absorb the light and become prominent as dark lines. The **VeinSpy™** device consists of two sets of coloured LEDs: one set emits orange light optimal for superficial veins, another set emits red light to find deeper veins.

#### Advantages of the VeinSpy™:

- reduces multiple needle prick and improves site selection for needle insertion
- no treatment delay due to difficult venous access
- reduces patient pain due to needle insertion
- increases patient comfort, avoids hematoma

### • 23451 PLASTIC SLEEVES FOR 23450 - disposable - box of 50

#### TECHNICAL SPECIFICATIONS

Number of LED's:	22 Orange, 8 Red
Functional opening:	17 mm
Viewing diameter:	33 mm
Rechargeable battery:	Lithium Ion, 3.7V, 1150mAh
Battery charger:	110-240 V AC input, 5V DC output 750mA
Battery life:	1½ hour continuous use
Dimensions - weight:	125x65x22.7 mm - 90 g



#### How to use VeinSpy™

- 1- Wipe the area of the patient's skin with alcohol swab.
- 2- Insert VeinSpy™ into the disposable sleeve and switch ON.
- 3- Move the VeinSpy™ across and forth to get a clear view of the specific vein.



23450

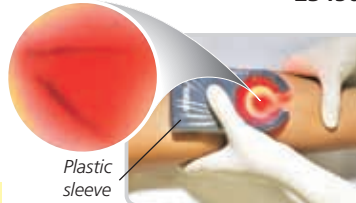

Plastic sleeve



4- After visualization of vein move the device so that needle can be inserted easily

5- Gently press the VeinSpy™ on the vein, insert needle into the vein through the open end of VeinSpy™

#### STANDARD ACCESSORIES

Rechargeable battery  
50 disposable plastic sleeves

Battery charger  
Multilingual manual: GB FR, IT, PT, ES.

## QV-500 PROFESSIONAL VEIN FINDER

### • 23456 QV-500 PROFESSIONAL VEIN FINDER

Portable vein finding device that can project blood vessels image on skin surface accurately and timely.

Ergonomic design with an advanced infrared imaging technology to provide real-time accurate vein digital image on patient's skin.

It helps doctors and nurses to easily find veins of obese or chemotherapy patients, hairy or dark skin people, people with varicose veins, fine blood vessels and vascular obstruction.

It can adapt seven different colours to different ages, body shapes, skin colors, weights and various operating environments. Suitable for adults, children and infants.

It allows to observe the vascular thickness, length, curve and branch information to determine the best puncture location to avoid pain. Also available optional table stand or mobile trolley.

### • 23457 TABLE STAND for 23456 - optional

### • 23458 MOBILE STAND for 23456 - optional

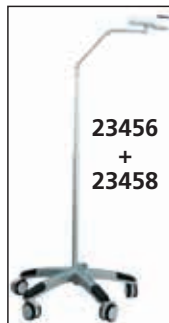

23456  
+  
23458



23456  
+  
23457

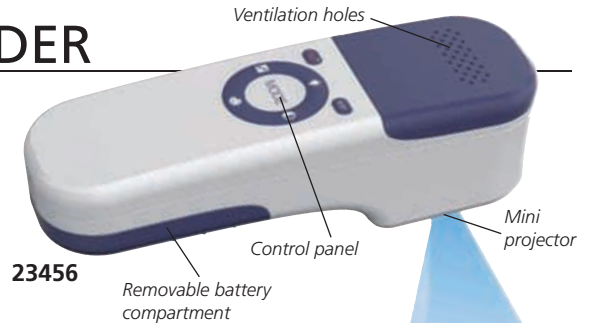

Ventilation holes

23456

Removable battery compartment

Control panel

Mini projector



7 different colours to better adapt to skin and environment conditions



#### STANDARD ACCESSORIES

Aluminium carrying case  
Surgical skin pen  
Tourniquet  
Calibration card  
Charging cable  
Adapter  
User manual GB, IT

#### TECHNICAL SPECIFICATIONS

Light: harmless infrared light  
Display: 5 level adjustable brightness  
Detection distance: 15-25 cm  
Accuracy: ± 0.3 mm  
Noise: ≤20 dB  
Battery: 3400mAh rechargeable lithium battery  
Power supply: output 5V 2.0A, input 100V-240V ac 50Hz-60Hz  
Size - Weight: 20x6.2x5.5 cm - 280 g

## MILITARY TOURNIQUETS

### • 25526 MILITARY TOURNIQUET - orange

### • 25527 MILITARY TOURNIQUET - black

Mainly used for stopping massive haemorrhage of limbs on field conditions or in normal pre-hospital emergency. Disposable easy to use, one-handed application tourniquet improving the efficiency of hemostasis. It can be self-applied or applied by a first responder, allowing a quick and easy regulation of the pressure needed. Suitable for both upper an lower limbs. Made of woven synthetic fabric with thermoplastic clasp and secure windlass. Size: 95x4 cm. Multilingual instructions: GB, FR, IT, ES, PT, DE, GR, Arabic.

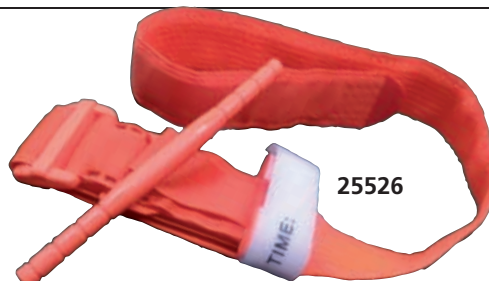

25526



25527

25526



## TOURNIQUETS IN LATEX, RUBBER AND LATEX-FREE

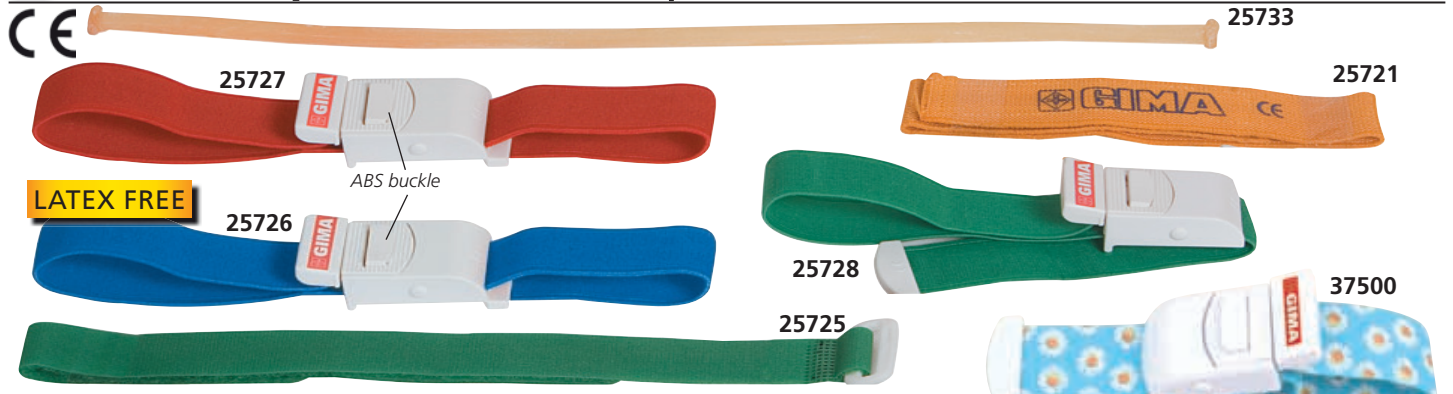

### GIMA TOURNIQUETS

Efficient and simple solutions for professional medical use.

**Latex:** Ø 5 mm, for manual use

**Velcro:** for easy fastening

**Velcro "D" buckle:** self applicable made of a nylon band threads through plastic "D" buckle

**Lock system:** self applicable with a quick release system.

Multilingual box (excluding 25733): GB, FR, IT, DE, ES, PT, GR, Arabic.



GIMA code	TOURNIQUETS	Material	Colour	Length cm	Width cm	Fastening systems	Origin
25733	TUBOLARE Tourniquet - box of 200	Latex	Yellow	33	-	Manual	Europe
25721	GIMA Tourniquet	Rubber band, terylene cover	Yellow	40	2.5	Velcro	Asia
25725	STRIP-VELCRO Tourniquet	Velcro	Green	45	2.5	Velcro+ring: use with one hand	Asia
25727	FAST Tourniquet	Rubber band, terylene cover	Red	40.5	3	Single lock system: quick release	Asia
25728	FAST Tourniquet	Rubber band, terylene cover	Green	40.5	3	Single lock system: quick release	Asia
25726	FAST Tourniquet - latex free	Spandex band, terylene cover	Blue	40.5	3	Single lock system: quick release	Asia
37500	FAST Tourniquet - daisy	Rubber band, terylene cover	Blue pattern	40.5	3	Single lock system: quick release	Asia
37501	FAST Tourniquet - peace	Rubber band, terylene cover	Multi-color pattern	40.5	3	Single lock system: quick release	Asia
37502	FAST Tourniquet - space	Rubber band, terylene cover	Blue pattern	40.5	3	Single lock system: quick release	Asia

## JETPULL 2 TOURNIQUETS WITH GRADUAL ADJUSTMENT



### JETPULL 2 WITH GRADUAL ADJUSTMENT

Easy to use, allows single-hand operation.

Sophisticated 2 button system allows an easy opening of the fastening with 2 choices: smooth or fast, even when under tension. Fastening device is made using high class medical plastics (PVC free). Ribbon is in special material to avoid any skin bruises. Washable at 60/90° C and autoclavable.

### Jetpull system

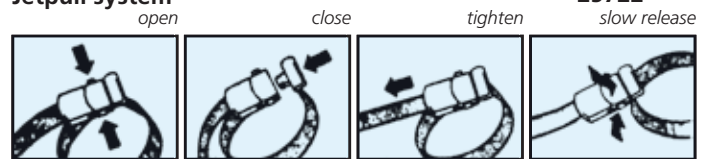

GIMA code	TOURNIQUETS	Material	Colour	Length cm	Width cm	Fastening systems	Origin
25722	JETPULL 2	Polyester/rubber	Blue	56	2.4	Double lock system: quick and slow release	Germany
25723	JETPULL 2 - latex free	Polyester/elastan	Green	56	2.4	Double lock system: quick and slow release	Germany
25724	JETPULL BABY	Polyester/rubber	Child design	56	2.4	Double lock system: quick and slow release	Germany

## TAPE TOURNIQUET

- 37515 TAPE TOURNIQUET - latex free - disposable - box of 25

Latex free disposable tape tourniquet made of TPE with dot surface. Each box contains 25 pre-cut tourniquets 45x2.5 cm (18"x1") with 0.636 mm thickness. Multilingual box: GB, FR, IT, ES, PT, DE, PL, GR, SE, HU, Arabic.



## PRE-CUT TOURNIQUETS

- 37510 PRE-CUT TOURNIQUET 45x2.5 cm - blue - box of 250
  - 37511 PRE-CUT TOURNIQUET 45x2.5 cm - orange - box of 250
- Latex free disposable tape tourniquet made of TPE with smooth surface. Thickness 0.636 mm. Multilingual box: GB, FR, IT, ES, PT, DE, PL, GR, SE, HU, Arabic.

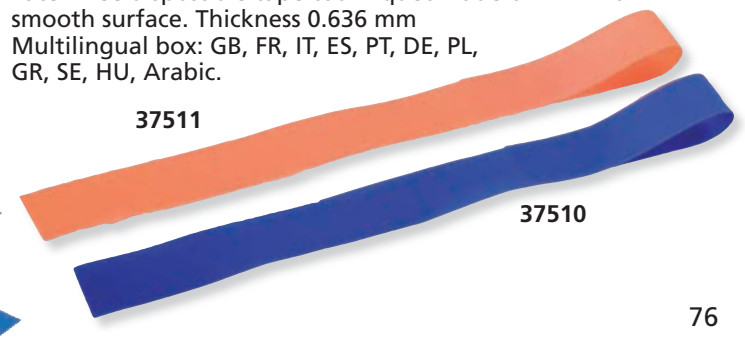

## HIGH QUALITY LEATHER BAGS

PRIME LEATHER

MADE IN ITALY



27120

27114

External dimensions:  
34x18xh 22 cm

- 27120 VALIGETTA - brown
  - 27114 VALIGETTA - black
- Rigid bottom, inside zip-fastener pocket and inside folding pocket.



27110

External dimensions:  
35x17xh 22 cm

- 27110 TEXAS leather - colour: chestnut
- Rigid bottom, inside pocket with button fastening, burnished lock.



27115



27116



27118

External dimensions:  
41x20xh 22 cm

- 27115 SUPERTEXAS leather - colour: black
- 27116 SUPERTEXAS leather - colour: chestnut
- 27118 SUPERTEXAS leather - colour: bordeaux

With outer pocket and inside zip fastener pocket, 2 burnished locks, inside transversal partition 8 cm from side, large central area.

## SIMULATED LEATHER BAGS

MADE IN ITALY



27100

27101

External dimensions:  
35x13xh 24 cm

- 27100 TEXAS skay - colour: black
  - 27101 TEXAS skay - colour: cognac
- Rigid bottom, inside pocket with button fastening, burnished lock.



27104

External dimensions:  
38x20xh 20 cm

- 27104 INFERMIERA skay - colour: cognac
- Rigid bottom, inside zip fastener pocket and inside folding pocket, burnished lock.



27108

External dimensions:  
45x20xh 25 cm

- 27108 LARGE POLUS skay - colour: cognac
- Rigid bottom, inside zip fastener folding pocket, elasticated retainers for instruments on both inside sides.



27105

External dimensions:  
41x20xh 22 cm

- 27105 SUPERTEXAS skay - colour: cognac
- With outer pocket and inside zip fastener pocket, 2 burnished locks, inside transversal partition 8 cm from side, large central area.



## FLORIDA LEATHER/PU BAGS



External dimensions:  
38x20xh 20 cm



- 27121 FLORIDA leather - burgundy
- 27122 FLORIDA leather - black
- 27123 FLORIDA leather - brown
- 27124 FLORIDA leather - chestnut



Rigid bottom, inside zip fastener central pocket, lateral inside pocket, burnished lock. Outside made of leather, inside made of PU (polyurethane). Made in Asia - Italian design.

## KANSAS BAGS - 5 COLOURS

- 27095 KANSAS skay - black
- 27096 KANSAS skay - chestnut
- 27097 KANSAS skay - blue
- 27098 KANSAS skay - ochre
- 27099 KANSAS skay - brown

Made in Asia - Italian design

Rigid bottom, outer velcro pocket, inside partition, inside zip pocket, lock with key.



External pocket with velcro closure

External dimensions:  
42x20xh 24 cm

## HEAT REGULATING BAG

• 27218 ENERGY HEAT REGULATING BAG  
Heat regulating bag for the warming of IV liquids. Used as an active source of heat is indicated for the prevention and treatment of hypothermia. Ideal for emergency medicine, hospitals and field camps. Its compact design allows for use both hung on the stretcher or in the ambulance as a bottle holder or inside bigger containers. The infusion liquids remain at a constant temperature and the IV liquids can be transported out of the ambulance for a short period. The main compartment is heated by an electrically fed resistive pad. Supplied with front pocket for the electric power supply cable, transparent identity pocket, cable with plug, adjustable shoulder strap and manual GB, IT.



27218

### TECHNICAL SPECIFICATIONS

Padding material: outside PVC, inside nylon 210  
Voltage supplies: 12 V DC, absorption 3,75 A  
Car lighter: DIN ISO 4165 Protection: IP3x

MADE IN ITALY

Size: 24x14xh 33 cm Weight: 1,2 kg  
Isolation: Class II

## VACCINE CARRIER

- 27211 PROFESSIONAL VACCINE CARRIER

Compact, extra strong with special insulation guaranteed by high density PU foam, suitable for transportation of vaccines. Comes complete with 8 empty ice-packs 400 ml suitable for a cold life of 40 hours at 8°C with external temperature of 43°C without opening. Vaccine storage capacity: 2.6 l. Body and lid with gaskets for better insulation. External size: 28.5x25.5xh 32 cm. Internal size: 22x18xh 24 cm.



27211

MADE IN ITALY

## THERMAL BAGS

- 27209 THERMAL BAG - yellow - nylon
  - 27212 THERMAL BAG - blue - nylon
- Crafted, durable and insulated thermal bag with detachable shoulder strap. Supplied with pockets and 3 temperature packs, which maintain cold and hot temperature for long period. External size: 34x25x24 cm - Internal size: 30x23x21 cm
- 27206 THERMAL BAG TEMPERATURE PACK - pack of 2
  - 27216 DUAL SOFT ICE PACK 100+100 g
  - 27215 SOFT ICE PACK 200g

MADE IN ITALY



27209

27206



27215

27216



78

## UTILITY BAGS



27127



27125

Made of water resistant 600D polyester



Removable minibag

- 27125 UTILITY DOCTOR BAG - blue - empty
  - 27127 UTILITY DOCTOR BAG - beige - empty
- Practical doctor bag for easy transport of instruments and medications, provided with 8 internal movable divisions, 3 external pockets, 8 elasticated retaining, 1 internal pocket with zip, 1 removable mini bag (17x3xh 24 cm). Size: 36x22xh 25 cm.

## PROFESSIONAL BAG



27128

Weight: 3.3 kg.  
Maximum load: 5 kg  
External size:  
42x35x15 cm.



Made of 70D nylon (external) 600D polyester (internal)

- 27128 PROFESSIONAL BAG - empty
- Versatile bag, designed for general practitioners and any professional. It includes: 3 detachable transparent pouches with velcro, 1 ampoule holder with 23 elastic bands with velcro, 1 large pouch with 4 dividers with velcro, clip paper board, document holder, various pockets. Shoulder strap, handle, hidden straps to carry on back.

## MULTIUSE BAGS



27134



27135

- 27134 MULTIUSE BAG - blue/grey
  - 27135 MULTIUSE BAG - brown/beige
- Versatile bag, designed for nurses to carry medical supplies. Internally supplied with 2 detachable transparent pouches, one removable mini bag, 4 internal movable divisions, one side document holder pocket with strap closure and 2 applied pockets. Large external pocket with 2 internal dividers. Provided with carrying handle, zip closure, non-slip rubber pads and nametag on the back. Size: 38x10xh 30 cm.

## DIATERMO BAG



Size:  
30x40xh14 cm

27139

- 27139 DIATERMO BAG - black - 600D polyester
- Designed to carry small electro-surgical units, audiometers, spirometers, ECG with their accessories. One removable partition to separate device from accessories and one zip pocket.

## MULTIUSE SOFT CASES

- 27137 MULTIUSE SOFT CASE - 28x12.5x6.5 cm - black
  - 27138 MULTIUSE SOFT CASE - 28x12.5x6.5 cm - blue
- Inner insert divides this bag into two compartments, one for stethoscope, one for nurse accessories.

27137

Bottom compartment with one elastic pocket and one transparent zipper pocket. Upper compartment with 6 elastic loops, one transparent zipper pocket and one mesh pocket. Double zip for easy access. Supplied with carrying handle.



27138

## SMART TROLLEY BAG



27141



- 27141 SMART TROLLEY BAG - 56x32.5x49 cm

Trolley bag made of strong, water resistant 600D polyester with durable cold resistant wheels. Extremely capacious with internal adjustable compartments which permit personalized organization of the space.

Provided with external pockets, internal divisions, and one removable pouch with transparent window. Waterproof rubber bottom to prevent water infiltration.

# MEDIPOCKET AND MEDINSULINE INSULATED COOL BAGS



MEDI POCKET 12x65xh 20 cm

## INSULATED COOL BAGS

Compact insulated bags for insulin and thermolabile medicines transport. High quality insulating material and finish. Waterproof zips. Internal pocket with zip. Supplied with 1 reusable gel cushion.



Opening of 27207/8, 27252



Interior of 27203  
MEDINSULINE 10x5xh 18 cm



27216  
Dual soft ice pack 100 + 100 g

Blue/beige	Red/white	DarkGrey/beige	INSULATED BAGS
27252	27207	27208	Medi Pocket
		27203	Medinsuline
27216	Dual soft ice pack 100 + 100 g		

## VIAL BAGS



For 24 small phials

For 9 large and 13 small phials

Central partition with double transparent pocket

27133

- 27129 MAXI VIAL BAG - red - 600D polyester - 29x24xh 7 cm  
The best way to protect, identify and organize up to 46 phials of any size. Made of two parts, with elastic strips for holding 9 big and 37 small ampoules.
- 27133 MEDICATION BAG - blue - 600D polyester - 34x24xh 7 cm  
Compact bag made of water-proof anti-scratch 600D polyester: 2 internal zip pockets and 9 elasticated retainers.

## DIABETIC BAG



Size: 17x11.5x5.5 cm

27254

Temperature pack 100 cc

27255

Size: 24x18xh 6 cm

MADE IN ITALY

- 27255 DIABETIC BAG - empty - blue
- 27254 MINI DIABETIC BAG - empty - blue  
Thermal pharmaceutical bags designed specifically for carrying medicines that must be kept at cool temperatures, ideal for diabetics. Temperature pack included to provide a temperature of about 10°C for up to 10 hours. Exterior material is a water repellent vinyl nylon with a foam backing.

## POCKET ORGANIZERS



27142

Supplied with retractable badge holder

27143

- 27142 POCKET ORGANIZER - light blue
- 27143 POCKET ORGANIZER - lilac  
Pocket size organizers help professionals to have easy and fast access to needed tools. Multiple pockets can hold pens, thermometer, penlights ..... Size: 15x12xh 2 cm

## HOLSTERS - EMPTY



All holsters have belt loop

27145

27147

- 27145 FLAT HOLSTER - 19x14xh 1 cm
- 27147 LARGE HOLSTER - with pocket - 21x12xh 6.5 cm

## INSTRUMENT AND VIAL BAGS



Padded protection and velcro fastening

25742

25745

With zip closure

Padded in velvety cloth with protection and velcro

26650

26649

With zip closure

GIMA code	VIAL INSTRUMENT BAGS*	Size	Colour	For
25742	Vials bag	19.5x15xh3 cm	Blue	12 vials
25745	Mini Vials bag	18x14xh2 cm	Black	6 vials
26650	Instrument bag	19.5x15xh3 cm	Black	12 instrum.
26649	Mini Instrument bag	18x14xh2 cm	Black	8 instrum.

\*Made of 600D polyester (external)

## SMART EMERGENCY BAGS

### POLYESTER PVC COATED



27153 27152 27150  
Shoulder straps included with medium and large bag.  
4 pockets (5 for 27153) 1 or 2 on front, 2 on sides and 1 on back



27153

### PVC TARPAULIN



27157 27158 27155  
Large pocket on top and shoulder straps included with medium bag



Removable lining for easy cleaning  
Large pocket on top

27157

Padded bottom and frontal pocket



Safe metal buckles Large 10 mm zips Rubber bottom with feet Shoulder straps

**SMART BAGS: polyester PVC coated or PVC tarpaulin - empty**  
Professional emergency bags extremely capacious with internal adjustable compartments which permit personalized organization of the space. Provided with external pockets, internal divisions, and one (2 for code 27153) removable pouch with transparent window. Bags are externally made of strong, water resistant 600D polyester PVC coated or cold resistant PVC tarpaulin (27155-8). All bags are internally made of 600D polyester PVC coated. Provided with double yellow reflective strips. Internal lining is removable for easy cleaning. Waterproof rubber bottom to prevent water infiltration.

External material	Model	Colour	Size	Internal modular spaces	External pockets
Polyester PVC coated	27150	Small	red	45x28xh 28 cm	3
PVC	27155	Medium	red	55x35xh 32 cm	4
	27151	Medium	red	55x35xh 38 cm	6
	27157	Medium	red	55x35xh 38 cm	6
	27152	Medium	blue	55x35xh 32 cm	6
	27158	Medium	black	55x35xh 38 cm	6
	27153	Large	red	65x35xh 35 cm	6

## EMERGENCY BAGS - POLYESTER PVC COATED OR PVC

### POLYESTER PVC COATED



27165 27167 27166



2 lateral pockets 22x18 cm and 11x18 cm

27167

Lateral pocket 32x18 cm

Front pocket 35x20 cm

- 27165 EMERGENCY BAG - polyester - red - 35x45xh 21 cm
  - 27166 EMERGENCY BAG - PVC - red - 35x45xh 21 cm
  - 27167 EMERGENCY BAG - PVC - blue - 35x45xh 21 cm
- Capacious bag, despite the compact size. Large central compartment, 1 front and 3 lateral pockets. May be carried on shoulder (braces) or hand (2 handles).

Made of strong, water resistant material 600D polyester PVC coated (27165) or PVC tarpaulin (27166-7). Provided with yellow reflective strips and rubber bottom.

## CUBO EMERGENCY BAG



27163

• **27163 CUBO EMERGENCY BAG - PVC tarpaulin - red**  
 Portable emergency bag with internal and external zip pocket and 2 removable pouches with transparent window. Interior made of strong, water resistant 600D polyester with outer PVC. Provided with double reflective yellow strip. Size: 28x34x13 cm.

## LIFE-2 EMERGENCY BAG



27161

Shoulder or hand portable.

• **27161 LIFE-2 EMERGENCY BAG with 5 coloured pouches**  
 2 section first-aid bag with double opening zip: bottom side with shockproof inner basin, upper side with 5 removable coloured pouches (model E1) with transparent window. Made of strong, water resistant 600D polyester PVC coated material with reflective yellow strips. Size: 49x28xh 33 cm.

## EMERGENCY TROLLEY BAG

Trolley bag and rucksack made of strong, water resistant 600D polyester (27154) and PVC (27173) with durable cold resistant wheels.

• **27154 EMERGENCY SMART TROLLEY BAG - 56x32.5x49 cm**

Extremely capacious with internal adjustable compartments which permit personalized organization of the space. Provided with external pockets, internal divisions and one removable pouch with transparent window. Double yellow reflective strips. Waterproof rubber bottom to prevent water infiltration.



27154

• **27173 EMERGENCY LOGIC 2 PVC TROLLEY RUCKSACK - 49x31x57 cm**

Supplied with 6 coloured pouches with transparent window and velcro strips, 2 frontal pockets and 2 lateral pockets. Internal velcro strips and elastics, to retain instruments. Central division with zip and elastics. Provided with yellow reflective strips and shoulder straps.



27173



27154

27173

## POUCHES WITH VELCRO

Padded back and front **E5 27197**



E3 27188



**E2 27184**



**E4 27194**



Padded back

## POUCHES WITH VELCRO MADE OF 600D POLYESTER

All pouches are provided with a large strip of female velcro on back or side to be fixed to Gima emergency bags.



E1 27180



E6 27200

Model	Size - cm	RED	BLUE	YELLOW	GREEN	Standard with
E1	20x11x8	27180	27181	27182	27183	27161
E2	28x12x10	27184	27185	27186	27187	27170/1/4/5, 27150-8
E3	28x15x11	27188	27189	27190	27191	27171
E4	33x15x11	27192	-	27194	-	27151/2/7/8, 27175
E5	29x19x11	27196	27197	27198	27199	27174
E6	38x10x5	27200 grey colour				

## NYLON BAGS IN 5 COLOURS

NYLON BAGS - 22x15.5 cm				
Blue	Green	Red	Black	Grey
32791	32793	32794	32795	32796



Provided with zip closure and external pocket with velcro closure

## LOGIC-1 RUCKSACK

27170



• 27170 LOGIC-1 RUCKSACK - polyester - medium - 40x20xh 47 cm  
Supplied with 5 coloured pouches with transparent window and velcro strips, 2 frontal pockets and 2 lateral pockets. Internal velcro strips and elastics, to retain instruments. Provided with yellow reflective strips.



27170

## LOGIC-2

## RUCKSACKS

POLYESTER  
PVC COATED

27171



• 27171 LOGIC-2 RUCKSACK - polyester - large - 40x25xh 47 cm

• 27172 LOGIC-2 RUCKSACK - PVC - large - 40x25xh 47 cm  
Rucksack externally made of strong water resistant 600D polyester PVC coated (27171) or PVC tarpaulin (27172). Supplied with 6 coloured pouches with transparent window and velcro strips, 2 frontal pockets and 2 lateral pockets. Internal velcro strips and elastics, to retain instruments. Central division with zip and elastics. Provided with yellow reflective strips and shoulder straps.



27171



27172



PVC TARPAULIN

27172

## AMBULANCE RUCKSACK

27174



Large 10 mm zips

27174



Rubber bottom



27174

• 27174 AMBULANCE RUCKSACK - polyester  
Modular extra large rucksack provided with 8 internal pouches, 4 coloured with handle (model E5) and 4 coloured with transparent window (model E2). Velcro internal strips for pouches fixing. Provided with double yellow reflective strip.  
Size: 40x30xh 57 cm

## SILOS-2 RUCKSACKS

POLYESTER

27168



Velcro removable plate

• 27168 SILOS-2 RUCKSACK - polyester - blue - 38x24xh 50 cm

• 27169 SILOS-2 RUCKSACK - PVC - red - 38x24xh 50 cm  
Professional rucksacks made of strong water resistant 600D polyester PVC coated and with outer PVC (27169 only)  
- removable compartment with 4 transparent pockets and many elastic strips  
- central storage space with 3 pockets, velcro strips and elastic strips  
- two external pockets with elastic strips and velcro strips: one 35x16 cm, one 35x32 cm with 4 internal transparent pockets  
- rubber bottom with 4 feet  
- two removable external plates for printing name  
- comfortable back shoulder straps and plastic handle on both sides.

POLYESTER WITH  
OUTER PVC COATING

27169



27169



## IP67 CERTIFIED, TOUGH, DURABLE CASES



**WATERPROOF & DUSTPROOF**

- 1 - Watertight seal around lid
- 2 - Automatic pressure release valve
- 3 - Easy to open double throw latches
- 4 - Load tested soft grip handle
- 5 - Holes for double padlocking
- 6 - Holes for shoulder strap
- 7 - Stackable interlocking system
- 8 - Thick body material
- 9 - Extra fixing points
- 10 - Fully length hinges
- 11 - Nylon pins, corrosion free
- 12 - Pick N Pluck foams on bottom and convoluted foam in the lid
- 13 - Screen printing space on the lid

MADE IN ITALY

### GIMA CASES

GIMA cases are IP67 certified, tough, reliable and extremely durable in any condition. They offer superior protection from the elements, water, dust and impacts, making them suitable for a wide range of applications. Can be supplied with or without internal foam.



GIMA code	CASES WITHOUT INTERNAL FOAM		
	Internal size	External size	
27220	Medium - orange	426x290x159 h	464x366x176 h
27221	Medium - black	426x290x159 h	464x366x176 h
27222	Large - orange	500x350x194 h	555x428x211 h
CASES WITH INTERNAL FOAM*			
27226	Medium - orange	426x290x159 h	464x366x176 h
27227	Medium - black	426x290x159 h	464x366x176 h
27228	Large - orange	500x350x194 h	555x428x211 h

\*1 base foam + 2 cubed foams on bottom, 1 convoluted foam on lid.

## FUTURA ECO CASE

MADE IN ITALY

**100% RECYCLED MATERIAL**



34133

- 34132 FUTURA ECO CASE - beige
- 34133 FUTURA ECO CASE - orange

First eco-sustainable case, made of Compound PP/ Wood Flour (WPC-Wood Plastic Compound) with vegetable charges between 30-40%. It maintains all the qualities of wood, PP resistance and preserves the environment. Equipped with wall support, transport handle and closure with 2 rotating clips. Size: 250 x190xh 90 mm.



34132

## MEDICATION BAG



27132

- 27132 MEDICATION FIRST AID BAG - 31x22x11 cm

First aid bag provided with 2 internal transparent pockets, one external pocket, internal division with 2 zips on both sides, handle and carrying belt.

## EMPTY CASES - PLASTIC OR ALUMINIUM



Carrying handle, 2 snap closure clips

34450

- 34450 PLASTIC CASE - blue - empty
- Size 235x195x45 mm - 0.15 kg



34186

- 34186 PLASTIC CASE - empty
- Size 290x215x90 mm



2 snap closure clips. It can be hung on the wall by the two back holes.



34191

- 34191 PLASTIC CASE 1 - empty
- Size 460x345x145 mm



34138

2 internal removable separators, wall bracket, swivel catches and carrying handle

- 34138 PLASTIC CASE 2 - empty
- Size 395x270x135 mm - 1.6 kg



34148

- 34148 PLASTIC CASE 3 - empty
- Size 443x338x147 mm - 3.3 kg

Made of two parts, each divided into compartments by crystal partitions (7 on bottom side and 3 on upper side). 2 swivel catches closure. A wall bracket secures it on the wall or booth



34159

- 34159 ALUMINIUM CASE - empty
- Size 400x350x100 mm

10 small and 2 large elastic loops, 6 compartments

## GIMA PODOSCOPE WITH POLARIZED LIGHT

27363

Methacrylate

Multilingual manual:  
GB, FR, IT, ES, PT, DE



### • 27363 GIMA LED PODOSCOPE

The GIMA Podoscope with polarized light allows operators to observe the foot plant highlighting the points with the heaviest pressure. The patient stands on the methacrylate platform, an excellent light conductor, provided with an inner light source to detect variations of colour intensity on the foot plant, corresponding to higher or lower plant charge.

MADE IN ITALY

### Highly resistant, easy maintenance

The GIMA Podoscope with polarized light has been designed for a long lasting duration. High-quality material and components, serial assembly and control checks constantly performed during production and at final test, provide superior accuracy. Its structure is resilient and can bear charges up to 135 kgs - 297 lbs. Its green-light LED has a life of 25,000 hours (duration indicated by the manufacturer).

### Easy to use, light and practical

The GIMA podoscope becomes operative at once simply switching it on. Just after the patient has stepped on it, in real time you can proceed with the study. The device is meant to be practical and easy to use. Since methacrylate is light and resistant at the same time, the device can be comfortably moved from a place to another, also thanks to its limited dimensions. The step is low: 22 cm from ground level, so that even elderly patients can easily step on it.

#### TECHNICAL SPECIFICATIONS

Capacity: 135 kg - 297 lbs  
Dimensions: 43.5x42.5xh 22 cm - 17.12x16.75x8.67 inches  
Weight: 8 kg - 17.63 lbs  
Operating voltage: 220 V-50/60 Hz - Schuko plug (British plug available on request)  
Green light LED stripe with 25,000 hours of life

## POSTURAL ANALYSER

Adjustable upper mirror.

27387

### • 27387 POSTURAL ANALYSER

Device for analysing posture in the frontal, rear and lateral planes. The patient stands with feet in the positions indicated on the platform. It includes a platform, elastic grid, two aluminum side bars, measuring indicators with plumb line for postural reference (Barré's vertical evaluation) and adjustable mirror on top. The image reflected in this upper mirror allows observation of any rotation of the shoulders. Manual: GB, IT. On request ES.

Supplied with a set of three horizontal and two vertical elastics that are respectively adjustable in height and width by sliding. These elastics can be used as reference lines in the observation of the patient's upright posture and in the search for asymmetries and deviations.



Size: 60x66xh 220 cm  
Capacity: 200 kg

MADE IN ITALY

## PLUMBING WEIGHT

### • 27355 PLUMBING WEIGHT

Made of stainless steel (magnet) with wire length 150 cm. Supplied in wooden case. Size: 6.2x2.3 cm. Weight: 140 g.



27355

## LED PODOSCOPE

Working surface  
32x36 cm

### • 27353 LED PODOSCOPE

Device for the plantar analysis of the feet. It has a lacquered wooden structure and a crystal top with an inclined mirror below it for a real view of the sole of the feet, which highlights the points of greatest and least load. Double lateral illumination with high level effect lamps. Max Load 200 kg. Strong reliable and professional product.



27353

Size: 46x55xh 33 cm  
Weight: 15.5 kg  
Power: 100-240 V, 50/60 Hz

MADE IN ITALY

## SCOLIOMETER

### • 27351 SCOLIOMETER

Plastic instrument for the detection of the scoliosis (deviation of the spinal column on the lateral, left and right planes) and evaluation of its gravity. It allows to compare reports and define the evolution of the measured pathological process, reducing frequent radiographical tests. The small sphere oscillating within an air space indicates the spine inclination degree, compared to the horizontal plane.

MADE IN ITALY



Size: 16.8x6.4x1.5cm

27351

## GONIOMETERS

27340

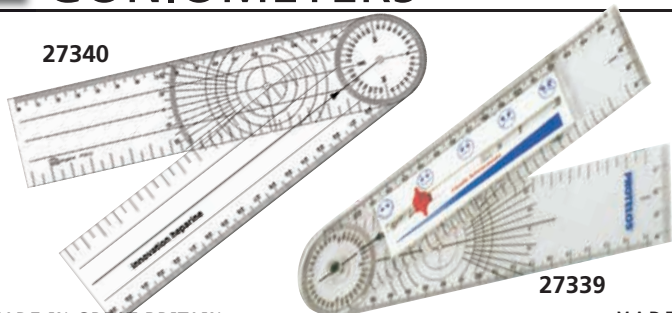

27339

MADE IN GREAT BRITAIN

MADE IN SPAIN

Used by orthopaedic surgeons to measure the range of movement of joints: elbows, knees and fingers.

### • 27340 GONIOMETER - 205x45 mm

With circular scale used to check the size of hip joints and the angle of the femoral neck on X-rays.

Personalisation with your logo for minimum 1,000 pcs.

### • 27339 GONIOMETER WITH PAIN SCALE RULER - 203x45x7 mm

27339



## BMI TAPES



- **27341 BMI - Tape Measure**  
Pocket retractable tape measure 150 cm. BMI (Body Mass Index) calculator on front panel.
- **27342 BMI - Tape Measure**  
Economical version of 27341 with same features.

## BMI CALCULATOR

Can be personalized with your logo for a minimum of 1,000 pieces.



- **27336 BMI CALCULATOR - box of 10**  
Used in hospital and surgeries gives an indication of general health through the ratio of weight to height. Made of 2 rotating discs: 108 mm diameter (base) and 76 mm (top).

## CIRCUMFERENCE MEASURING TAPE

- **27345 SECA 203 CIRCUMFERENCE MEASURING TAPE with extra Waist-To-Hip-Ratio (WHR) calculator**  
Retractable and ergonomic measuring tape for accurate determination of body circumference. Measuring range: 15-205 cm, division 1 mm. High-quality metal scale to obtain the Waist-To-Hip-Ratio (WHR). The WHR is an indirect method of determining the amount of abdominal fat tissue. The ratio allows conclusions about the distribution of fat stores and thus contributes to a diagnosis. Medical device, Class IM. Multilingual manual: GB, FR, IT, ES, DE, PT, PL.



## BODY TAPE

- **27343 BODY TAPE MEASURE**  
Sturdy vinyl tape to track body measurements and progress. Measures in inches and centimeters any body part: arm, thigh, calf, chest, waist, hip... Total measurement length: 60 inches / 152 cm. Push-button retraction and locking.



ensure easy measurement and superior accuracy.

Multilingual box and manual: GB, FR, IT, ES, PT, GR.

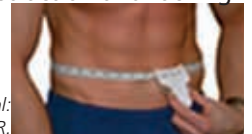

## PROFESSIONAL BODY - HEAD TAPE



- **27347 PROFESSIONAL BODY TAPE**
- **27350 PROFESSIONAL BODY TAPE with pediatric gauge box**  
Professional body tape measure for adult and pediatric use. Tape is coloured on both sides to help to identify metabolic risk in abdominal measure for male and female. Length of tape: 8-150 cm. Thanks to its rounded shape, it can be used also as a head measure tape. Packed in single box. **Body tape with pediatric gauge box (27350)** Specific tape for pediatric use. Supplied in a box with a ruler to compare the measured head circumference with the standard percentiles of children's growth from 0 to 36 months. Suitable for both sexes.

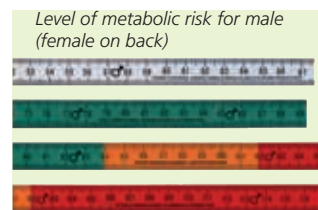

Multilingual manual: GB, FR, IT, DE, ES, GR, PT, Arabic.



## AISI 430 STAINLESS STEEL GONIOMETERS

All goniometers have manual in GB, FR, IT, ES



- **24900 FINGER GONIOMETER 6" - 15 cm**  
Finger goniometer measures range of motion of finger joints. Linear scale in inches and centimeters on arms. 180° scales marked in 5° increments.



- **24901 180° DIGIT GONIOMETER 6" - 15 cm**  
Allows taking readings using only one hand. Measures 110° flexion through 40° hyperextension in 5° increments.



- **24903 360° GONIOMETER 14" - 35 cm**  
This goniometer has two opposing 180° scale and one 360° scale all marked in 1° increments. Sturdy adjustable knob, controlling tension of arms.

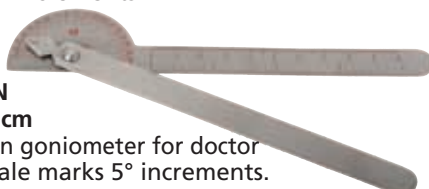

- **24902 180° ROBINSON GONIOMETER 7" - 17.5 cm**  
Pocket size 180° Robinson goniometer for doctor and therapist. Linear scale marks 5° increments.

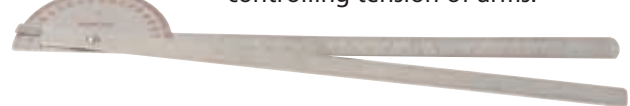

- **24904 180° EXTRA LONG ARMS GONIOMETER 14" - 35 cm**  
Extra long arms, useful for measuring all joints. Arm has a linear scale marked in 1° increments.

## MOBILE STADIOMETER

### • 27317 SECA 213 MOBILE STADIOMETER

Mobile stadiometer for measuring height, simple and easy to transport with integrated handle. The measuring rod can be dismantled into several pieces and set up easily and quickly. The spacer keeps the rod straight and stable without any fittings. Flexible position due to large floor plate which ensures stability. It guarantees precise and clearly visible reading of results. Suitable for adults and children and for measuring patients lying down.



Two large windows and double-sided scale for easy readout.

Multilingual manual in:  
GB, FR, IT, ES, PT, DE,  
PL, NL, GR, DK, SE,  
NO, FI.



Integrated handle and secure catches on all individual parts for transport ease.



27317

Large platform for stability.

#### TECHNICAL SPECIFICATIONS

Measuring range:	20-205 cm
Graduation:	1 mm
Size (open):	337x590xh 2,130 mm
Size (folded):	337x177x624 mm
Weight:	2.4 kg

## SECA INFANTOMETER



The unique V-shape automatically places the baby in the right measuring position



Size: 110x16.9x40.2 cm.

Weight: 3.8 kg.



The head and foot positioners lock into place to capture results. Indication can be read after measuring

### • 27316 SECA 416 - INFANTOMETER

Infantometer for measuring babies up to two years old. Sturdy construction and stability makes it quick and easy to use. Rounded sides guide the baby easily and safely into the right position. Permanently mounted with rollers on two guide rails, the footpiece slides smoothly along the scale. Footpiece is lockable so the baby can be removed and the result noted later. Measuring range: 33-100 cm. Graduation: 1 mm.

## BABY MEASURE

### • 27326 BABY MEASURE "CALIBRO"

Made of oxidized aluminium, metric graduation 0-900 mm, division 5 mm. Certified by Italian "weights and measure institute". Weight: 300 g.



MADE IN ITALY

27326



## ELECTRONIC HEIGHT ROD - ADULT AND PEDIATRIC



27333

LCD digit height: 9 mm

Switchable to inches

Includes adapter for attachment to baby scales 27306, 27260

Power supply: 2x1.5V AAA batteries

Size: 345x92x28 mm  
Power supply: 2x1.5 V AA batteries

Weight: 300 g



Size: 630x290x70 mm

### • 27264 SOEHNLE BABY HEIGHT ROD

Digital and mechanical rod 35 to 80 cm, division 1 cm. LCD display, digit height 16 mm. Manual in 23 languages.

27264

### • 27333 SOEHNLE ELECTRONIC HEIGHT ROD

Measuring range: 50-240 cm (20-94.5 inches), division: 1 cm. Manual in: DE, GB, FR, ES, IT, GR, CZ.

## HEIGHT MEASURE

### • 27335 TAPE HEIGHT MEASURE

Clear scale 0-200 cm. Easy wall fixation. Supplied with screw for wall mounting. Multilingual box and manual: GB, FR, IT, ES, PT, DE, PL, RO, HU, FI, GR, Arabic.

27335



## BONE MEASURE

### • 27325 BONE MEASURE

Slide-knot caliper in anticorodal to measure knee, shoulder, wrist, elbow... Measuring capacity: 150 mm. Burner length: 100 mm. Tested by Italian "weights and measures institute".



MADE IN ITALY

27325



## CRANIOMETRO - HEAD MEASURE

### • 27327 CRANIOMETRO - HEAD MEASURE

Made of special, soft, non stretchable plastic. Measures child head girth up to 60 cm. Instructions: GB, FR, IT, ES.



27327

MADE IN ITALY



## ORCHIDOMETER

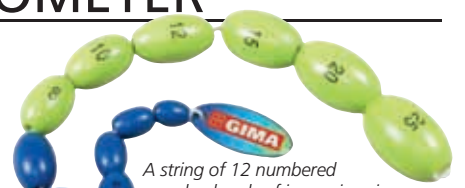

27337

A string of 12 numbered wooden beads of increasing size from about 1 to 25 mm used to determine size of testicles.

### • 27337 ORCHIDOMETER - wood

Used by pediatricians for screening of children's testicles. Multilingual box and instructions: GB, FR, IT, ES, PT, DE, GR, NL, SE, PL, FI, CZ.

## HOSPITAL DIGITAL BABY SCALE



CE 0123

M Class III  
27267

- 27267 SECA 376 HOSPITAL SCALE - digital class III
- high-quality Seca scale technology with fine 5-gram graduation
- TARE, HOLD, auto-HOLD and BMIF for extra convenience
- extra large and ergonomic tray for safe weighing
- adjustable damping
- large display for easy reading
- network-capable with secas 360° wireless technology

### TECHNICAL SPECIFICATIONS

Capacity: 20 kg      Sensitivity: 5 g up to 7.5 kg, 10 g from 7.5 kg up  
Dimensions - weight: 620x190x358 mm - 3.7 kg  
Platform: 615 x 130 x 275 mm      Battery operated

### WIRELESS TECHNOLOGY - optional

With the secas 360° wireless technology the secas 376 can transmit measurements to the optional secas 360° wireless printer. With the network-capable software secas analytics 115 and wireless USB adapter secas 456, your PC can receive and analyze measurements and forward them to an Electronic Medical Records (EMR) system. Thus the secas 376 is EMR-integrated and ready to handle digital patient records and all the demands the future will bring. More information about EMR integration is at [www.seca.com](http://www.seca.com)

## GIMA MECHANICAL BABY SCALE

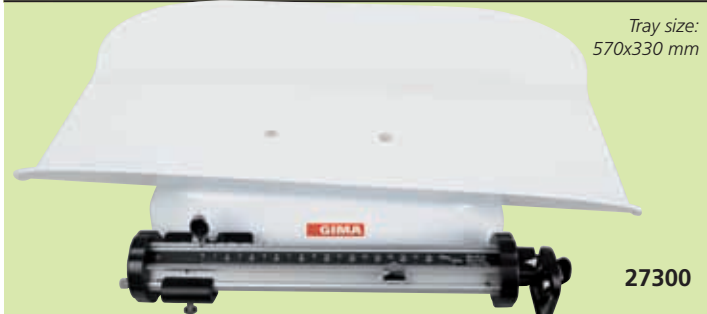

Tray size:  
570x330 mm

27300

- 27300 GIMA MECHANICAL BABY SCALE
- High quality sturdy mechanical baby scale for accurate and sensitive weighing. Supplied with curved weighing tray, aluminium levers and pins, stable casing for safe weighing. User manual in GB, FR, IT, ES, PT, DE, RO, GR.

### TECHNICAL SPECIFICATIONS

Capacity: 20 kg      Sensitivity: 10 g  
Dimensions: 570x330x285 mm      Weight: 6.5 kg

## SECA ELECTRONIC BABY SCALES



The weighing tray can be removed quickly and easily at the touch of a button

CE

27283

27282

- 27282 SECA 354 - electronic
- 27283 SECA 384 - electronic - CE M Class III
- Two scales in one: with a comfortable tray to weigh in a reclining position, easily detachable to be converted into a floor scale.
- Breast-milk-intake function determines how much milk the baby has suckled.
- Other functions: tare, auto-hold, kg/lbs switch over automatic switch off.
- User manual: GB, FR, IT, ES, DE (27282-3), PT, PL, NL, GR, DK, SE, FI, NO (27283 only).

### TECHNICAL SPECIFICATIONS

Capacity: 20 kg      Sensitivity: 10 g < 10 kg > 20g  
Dimensions: 552x156x332 mm      Weight: 2.3 kg (27282), 2.8 kg (27283)  
Batteries operated      Made in Asia

## SECA MECHANICAL BABY SCALE



CE 0123

27299

- 27299 SECA 725 - mechanical
- 27294 SECA 745 - mechanical - CE M Class III
- The sturdy classic: with its softly curved weighing tray, the stable all-steel casing and the precise, smooth running weights, this model is the indestructible original baby scale.
- User manual: GB, FR, IT, ES, DE, PT, PL.

### TECHNICAL SPECIFICATIONS

Capacity: 16 kg      Sensitivity: 5 g (27299) 10 g (27294)  
Dimensions: 550x180x290 mm      Weight: 6.4 kg  
Made in Asia

## MEASURING MAT FOR BABIES

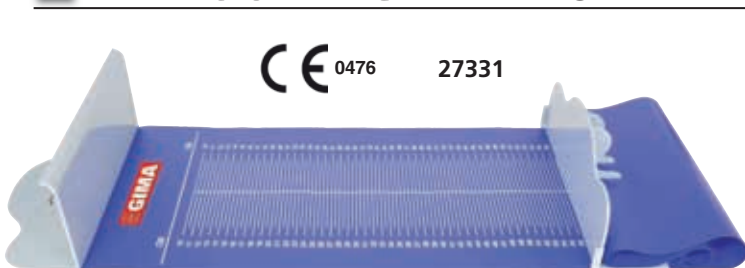

CE 0476

27331

- 27331 GIMA BABY MEASURING MAT
- Washable and foldable measuring mat for babies and toddlers, easy to carry. For easy and precise measurement of baby length. Size: 121x30 cm. Measuring range: 10-99 cm. Graduation: 5 mm.

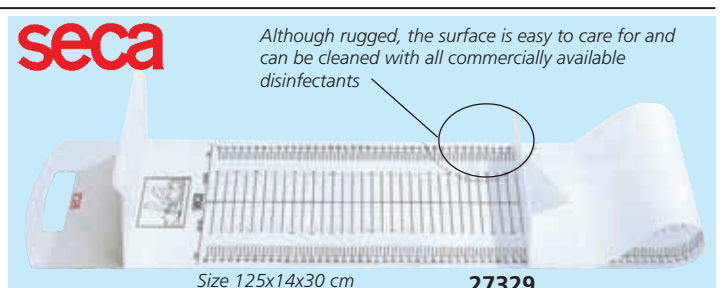

Although rugged, the surface is easy to care for and can be cleaned with all commercially available disinfectants

Size 125x14x30 cm

27329

- 27329 SECA 210 - BABY MEASURING MAT
- Mobile measuring mat for babies and toddlers. Kind to the skin, washable, foldable. The space saving solution for easy and precise measurement of baby length. Range 10-99 cm. Graduation: 5 mm.

CE 0123

## FOLDABLE BABY SCALE

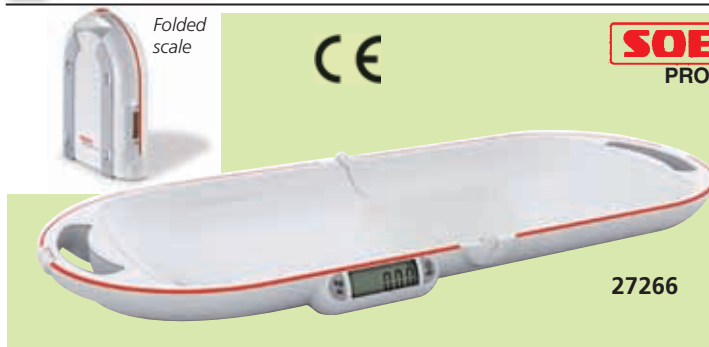

• **27266 SOEHNLE 8320 FOLDABLE BABY SCALE**

Foldable baby scale for easy transport. Folding mechanism with magnetic lock. Easy to open: remove the base and pull the handles apart. Taring function: pads, blankets placed under the baby are tarable. Steady weight display through filtering and hold function. Large LCD display easy to read. Switchable to kg/lb.

Manual in: DE, GB, FR, ES, IT, GR, CZ, Arabic.

• **27271 CARRYING BAG**



TECHNICAL SPECIFICATIONS	
Capacity:	15 kg
Sensitivity:	10 g
Dimensions:	395x315x105 mm (closed) - 740x315x53 mm (open)
Weight:	1.9 kg
Alkaline battery 2x1.5 V AAA - not included	Warranty: 2 years

## HOME CARE BABY SCALE



• **27306 SOEHNLE 8352 MULTINA DIGITAL BABY AND CHILD SCALE**

Well-designed, easy to handle plastic baby scale. - suitable for children up to 20 kg removing baby tray - easy to read LCD-display with 13 mm figures - simple operation with one button - tare function to calibrate for baby blankets/textiles - fully-electronic scale: no wear and tear parts, no maintenance - hold function: weight value will be held for 10 seconds after unloading - automatic power-off

• **27307 TRAY FOR 8352 - spare**

• **27264 BABY HEIGHT ROD - optional**

- see page 87



TECHNICAL SPECIFICATIONS			
Capacity:	20 kg	Sensitivity:	10 g
Dimensions:	601x346x92 mm	Weight:	3.5 kg
Battery:	9 V	Warranty:	2 years

MADE IN GERMANY

## BABY AND CHILD SCALE



• **27312 BABY AND CHILD DIGITAL SCALE**

Multifunctional scale with removable light plastic tray. It can be used with tray for babies or without for children.

Weight difference display function with memory: you can see the gain of weight of the baby after feeding.

Precise scale with easy-to-read LCD display.

Auto zero, auto tare, auto hold function.

Switchable to kg/lb/st.

Made in Europe.

TECHNICAL SPECIFICATIONS			
Tray dimensions:	525x305x63-95 mm	Capacity:	20 kg
Pack dimension:	540x300x110 mm	Sensitivity:	5 g
Battery operated:	2xCR2032 lithium batteries	Weight:	2 kg

## GIMA ELECTRONIC BABY SCALE



• **27313 GIMA ELECTRONIC BABY SCALE**

Handy, reliable and well-designed electronic baby scale.

Provided with large LCD display 66x28 mm and kg/lb switch.

Supplied with height tape meter and washable sheet.

Multilingual user manual and gift box: GB, FR, IT, ES, PT, DE, Arabic



TECHNICAL SPECIFICATIONS			
Capacity:	20 kg / 44 lbs	Sensitivity:	10 g
Dimensions:	595x340x90 mm	Weight:	4 kg
Battery operated:	4x1.5 V AA	Auto-off function	

## FAMILY BABY SCALE

• **27302 FAMILY BABY SCALE**

Baby scale for domiciliary and family use.

Capacity 20 kg/44 lbs.

Scale division: 50 g (0-10 kg), 100 g (10-20 kg)

Plastic tray. Dialplate in kg and lbs.

Manual zero adjustment.

Multilingual manual: GB, FR, IT, ES, PT, DE, Arabic.



## PROFESSIONAL SKINFOLD CALIPERS: MECHANICAL AND DIGITAL



- 27320 PLICOMETRO - Professional skinfold caliper - mechanical
- 27346 PLICOMETRO - Professional skinfold caliper - digital with PC cable for data transfer USB

This high precision instrument measures the thickness of a fold of skin with its underlying layer of fat giving physicians the situation of the subcutaneous tissues of the patient.

### Possibility of re-calibration

Produced to meet International Standards, the Gima "Skinfold caliper" has springs which exert a pressure of 10 g/mm<sup>2</sup> on the skinfold and an accurate scale which measures thickness in mm. With possibility of re-calibration of the pressure it solves the major problem of traditional skinfold caliper that is reduction of the tension of the spring in the time.

### Easy to use and read

With double reading scale (27320) or digital display (27346), it is supplied with picture showing advised positions for measurements. Tables will help obtain correct % of body fat from measured data and make a correct evaluation of the patient.

### Stylish and user-friendly

A special nylon finish makes the device feel skin, avoiding trouble of contact with metal. Made of metal and sold in an attractive wooden box (19x36x6 cm). User manual in GB, FR, IT (both models), ES, DE, (27320 only).

### Data management on PC (only 27346)

For immediate data transfer on most programmes (Excel, Word, Open Office, ...). Requirements: Windows 2000, XP (Service Pack 2), 7, Vista. USB 2.0 minimum.

## FAT-2 SKINFOLD CALIPER



- 27349 FAT-2 SKINFOLD CALIPER
- Aluminium, light weight skinfold caliper to measure body fat. Large, easy to read 0-67 mm scale. Supplied with a protective carrying case and measuring procedure. Multilingual manual in: GB, FR, IT, ES.



## FAT-1 SKINFOLD CALIPER

- 27344 FAT-1 SKINFOLD CALIPER
- Economic but precise and accurate skinfold caliper for professional use. Measures the thickness of skin folds over the body, based on the characteristics developed by Tanner and Whitehouse:

- pressure on the fold: approx 10 g/mm<sup>2</sup>
- contact surface on the fold: approx 6x11 mm

It allows a correct evaluation of the nutritional status and the sectoral distribution of adipose tissue. Raise a fold of skin with your fingers and measure its thickness by the forceps (max opening 4 cm): on the top edge a scale in millimeters and an arrow measure the skin fold (triceps, subscapular muscles, etc...) with an accuracy of about ±2 mm. The coloured bands

placed near the scale allow a simultaneous comparison of the measured value with referential percentages related to men and women. Advised in dietetics, cardiology, sports medicine, aesthetic medicine, gynaecology, pediatrics, ecc... Multilingual manual: GB, FR, IT, DE, ES, GR, PT, Arabic.

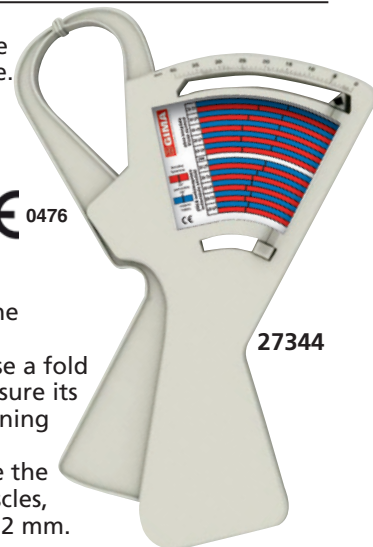

CE 0476

MADE IN ITALY

## BODY FAT CALIPER

- 27318 BODY FAT CALIPER
- plastic

Size 16.5x10x0.5 cm. Weight 22 g. Supplied into a polybag in a paper box. Multilingual box and manual in: GB, FR, IT, ES.

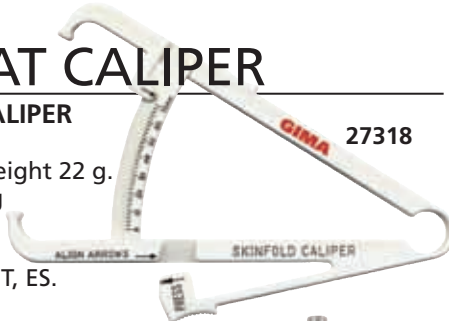

## HAND DYNAMOMETER

- 28791 SMEDLEY HAND DYNAMOMETER - aluminium
- Spring type hand dynamometer used to measure grip strength. Adjustable handle comfortably accommodates any hand size. Dial indicator remains at maximum until reset and is calibrated both in kg (0-100) and pounds (0-220). Manual in: GB, FR, IT, ES.

28791

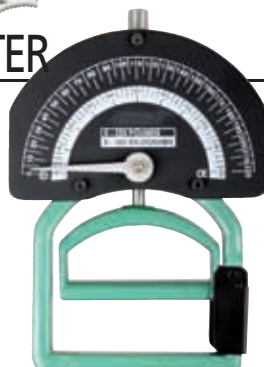

## HAND GRIP METER

- 28790 HAND GRIP METER - plastic
- Indicator remains at maximum until reset and is calibrated 0-75 kg. Size 20x15 cm. Sold in a blister. Manual in: GB, FR, IT, ES.

28790



## BODY FAT ANALYZER

• **27322 GIMA BODY FAT ANALYZER with carrying case**  
 Ideal for dieticians, gymnasias, sports centres and homecare. It helps manage nutrition, fitness and weight control and can indicate the right weight and nutritional health status. It measures the flow of electrical signals (total body electrical resistance or impedance) as they pass through FAT, LEAN (muscle, bones, vital organs) or WATER. When the amount of fat, lean or water changes, so does the Body Fat signal, giving a highly reliable and accurate measure of the amount of each component that makes up total weight. Specifically, 4 electrodes are placed over metacarpus and metatarsus where a 50 kHz current is introduced. The detected signal level will be an index of total body water and fat free mass.

**Only 2 minutes for an essential and easy test**  
 Testing and results take less than two minutes and have the same accuracy as other more expensive devices.

**Portable and lightweight** for performing test everywhere  
**Body Fat Analyzer helps get and stay fit.**

It helps maximize or maintain personal level of fitness:  
 - enables to check effectiveness of weight loss programme, telling exactly where weight loss is coming from (fat-lean-water)  
 - it helps monitoring improvements in muscle mass  
 - establishes a baseline for body composition, so that nutritional and fitness improvements can be regularly monitored. **Frequent calibration** (code 27324 calibration kit) is necessary for accurate results in the time.

- 27321 SENSOR CABLES (kit of two) - spare
- 33378 SENSOR PADS 3.2x2.2 cm (box of 100) - spare
- 32205 9V ALKALINE BATTERY • 27324 CALIBRATION KIT

27322  
 CE



Supplied with carrying case, kit of 2 sensor cables, sensor pads (box of 20), 2x9 V batteries, transformer, manual (GB, IT, FR, ES).

### DETECTED DATA

<b>FAT:</b>	actual weight of fat on the body
<b>LEAN:</b>	actual weight of lean, mostly muscle and vital organs
<b>WATER:</b>	water content in the body
<b>% FAT:</b>	% of fat weight in total body weight
<b>% LEAN:</b>	% of lean weight in total body weight
<b>BMR:</b>	basal metabolic rate
<b>Target Weight:</b>	weight goal under optimal condition
<b>Target % Fat:</b>	normal % for sex and age

### TECHNICAL SPECIFICATIONS

Size: 66x176x208 mm	Weight: 1,500 g (unit, battery and probe)
Test frequency: approx. 50 kHz	Test current: less than 1mA
Power source: two 9 Volt DC batteries or 230 V (by transformer)	

## FITNESS SCALE

• **27286 SOEHNLE 7850 FITNESS SCALE**  
 Fitness scale for measurement of muscle, fat and water components, BMI and caloric needs per day  
 - impedance measurement through hands, no need to take off the shoes  
 - simple self-explanatory menu guide on the glass surface  
 - no limit on measurement for over- and underweight people  
 - clothing weight value seasonally adjustable  
 - print-out of data/time, weight, data analysis and recommendations for nutrition and fitness activities  
 - software to edit the print-out and settings in DE, GB, FR, NL, ES, IT, HU, CZ, FI, SE, NO, DK, GR, PL, SI, RU, TR can be downloaded from [www.soehnle.com](http://www.soehnle.com)

- kg/lbs/st selection function  
 Manual in: GB, FR, IT, DE, CZ.

- 33250 PAPER ROLL 57mm x 25m - box of 5

Extra large weighing platform

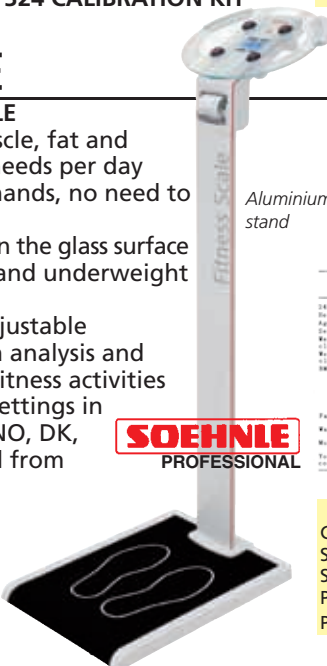

**SOEHNLE**  
 PROFESSIONAL



### TECHNICAL SPECIFICATIONS

Capacity:	180 kg
Sensitivity:	100 g / 0.2 lb
Size - weight:	365x490xh 1,290 mm - 15.8 kg
Platform size:	365x480xh 45 mm
Power supply:	100-240 V, 50/60 Hz

## FITBAND ACTIVITY HEALTH TRACKERS

- 27234 FITBAND ACTIVITY HEALTH TRACKER - black
- 27237 FITBAND PLUS ACTIVITY HEALTH TRACKER - black

Waterproof intelligent bracelets for tracking different parameters.

They monitor: temperature (only 27237), heart rate, calories, blood pressure, SpO<sub>2</sub>, sleep (only 27237), steps + distance and different sports.

They can be switched on three kinds of sports mode (running, cycling, rope skipping).

They also show call reminders and rejection, information push, weather, stopwatch, alarm clock and photos.

Wireless connection to Dayband App for data management.

Multilingual manual: GB, FR, IT, ES, DE.

### TECHNICAL SPECIFICATIONS

Display:	4 level brightness adjustment	Liquid protection:	IP67
Size - weight:	42x23x9.5 mm - 25 g		
Battery capacity:	90 mAh		
Power supply:	USB rechargeable battery		



27234

4 Health parameters  
 + step & distance + 3 sport activities



27237

6 Health parameters  
 + step & distance + 5 sport activities



## OMRON VIVA

### • 27291 OMRON VIVA HBF-222T-EBK

OMRON VIVA is a Medical Device with Clinically Validated Accuracy of key parameters that allow to better understand heart's health and predict cardiovascular events, tracking blood pressure and heart rate. It monitors **6 precise body metrics: visceral fat, fat, skeletal muscle, resting metabolism, BMI and weight**, using Bio-electric Impedance Analysis (BIA) Technology to assess body composition. Automatic User Recognition function with 4 users + Guest option, 4 seconds fast reading, Auto ON/OFF function and large LCD display. Results can be shared with the "OMRON connect" App. Made of stainless steel and glass. It includes 4xAAA batteries, setup instructions and multilingual manual: GB, FR, IT, ES, DE, NL, TR, RU, Arabic.



27291

Foot electrodes



Feet x 4



#### TECHNICAL SPECIFICATIONS

Capacity:	150 kg	Size:	285x280xh 28 mm
Weight:	1.6 kg	Power supply:	4xAAA alkaline batteries (included)
Memory:	30 readings	Protection:	IP21

## OMRON BF511 BODY COMPOSITION MONITOR

### • 27293 OMRON BF511 BODY COMPOSITION MONITOR

OMRON BF511 provides full body measurement with clinical accuracy, it is validated and classified as a medical device, even for kids. It offers a comprehensive set of readings including body and visceral fat, skeletal muscle level, BMI and resting metabolism. Measurement with 8 sensors on both hands and feet for complete body measurement. It uses the Bioelectric Impedance (BI) method, fat is shown as a percentage of body weight. Multilingual package and manual (GB, IT, FR, DE, NL, RU, Arabic). Battery operated: 4xAA (included).



27293

Resting metabolism is the minimum number of calories needed to sustain you every day



## BODY COMPOSITION MONITOR

### • 27092 OMRON BF212 BODY COMPOSITION MONITOR

Measures and displays the following body composition parameters: body weight, body fat (in %) and Body Mass Index (BMI). The 4-sensor technology provides clinically validated body measurements. It measures the body fat percentage by Bioelectrical impedance (Bi).

Capacity  
150 kg  
(330 lbs)

Auto  
switch off



27092



Foot electrodes



Supplied with multilingual manual (GB, FR, IT, ES, DE, NL, RU, Arabic)

## NEMESI BODY FAT SCALE

### • 27270 NEMESI BODY FAT SCALE

Full display body analyser with 4 high precision G sensors. It measures body fat, water, muscle, bone and BMI. 8 user memories. Extra large LCD with backlight full display with dual-line reading and mechanical button. Ultra slim design. Auto on function. 6 mm platform made of tempered glass, electrodes made of stainless steel.



27270

#### TECHNICAL SPECIFICATIONS

Capacity:	180 kg	Size:	330x320xh 19.4 mm
Division:	0.1 kg	Weight:	7.08 kg
Unit:	kg/lb/st	Power supply:	4xAAA batteries (with backlight)

## LIBRA BODY FAT SCALE

### • 27089 LIBRA BODY FAT SCALE - black

Multifunction scale, for measuring body fat, water, muscle and bone mass. Supplied in coloured box with multilingual manual (GB, FR, IT, ES, PT, PL) - 4 precision G sensors - 8 user memories - 3 touch buttons for easier usage - auto off in 30 seconds - auto-on function

#### TECHNICAL SPECIFICATIONS

Capacity:	150 kg / 330 lb - min. 5 kg
Switchable:	kg/lb/st
LCD Size:	62.5x62 mm
Batteries:	(included)
Sensitivity:	100 g / 0.2 lb
Size:	310x310x18.8 mm



27089

Weight and analysis of results shown on scale

## EQUILIBRA BODY FAT SCALE

### • 27269 EQUILIBRA BODY FAT SCALE - white

Body fat scale with intelligent SENSE ON technology. It monitors BMI, body fat, water, muscle and bone. Provided with large LCD display with backlight and safety tempered glass platform. Memory function and auto on and off function. Overload and low battery indicators. Supplied with 4xAAA batteries. Multilingual box and manual (GB, FR, IT, ES, PT, DE)

#### TECHNICAL SPECIFICATIONS

Capacity:	180 kg	Switchable:	kg/lb
Division:	0.1 kg	Size:	300x300x h 21.6 mm
Display:	LCD, 74x38 mm	Weight:	6.40 kg
Power supply:	4xAAA batteries (included)		



27269



## GIMA BIG DIAL SCALES



27239

### TECHNICAL SPECIFICATIONS

Capacity: 160 kg Sensitivity: 1,000 g  
 Minimum measuring weight: 5 kg  
 Dial Ø: 180 mm Weight: 3 kg  
 Dimension: 430x380x70 mm

- **27239 GIMA BIG DIAL SCALE**  
 Mechanical scale with classic design: a large and clear dial, a robust housing made of steel. Supplied in multilingual gift box. Made in Europe.



- **27240 GIMA DIGITAL BIG DIAL SCALE**  
 Digital scale with extra large, easy to read LCD display (65 mm). Strong and durable steel construction, comfortable platform. Lb/kg/st switchable by user. Supplied in multilingual gift box. Made in Europe.

Multilingual manual and box:  
 GB, FR, IT, ES, DE, PT, GR, Arabic



27240

### TECHNICAL SPECIFICATIONS

Capacity: 225 kg Sensitivity: 100 g  
 Minimum measuring weight: 2 kg  
 Power: lithium battery (included)  
 Dimension: 430x380x70 mm



## MECHANICAL SCALE



27230

- **27230 MECHANICAL SCALE**  
 Analogue bathroom scale with stable construction and plastic cover. Multilingual box and manual: GB, FR, IT, ES, PT, DE, GR, HR, HU, SI, RO, EE, LT, LV, CZ, PL, RU, Arabic.

### TECHNICAL SPECIFICATIONS

Capacity: 125 kg (275 lb)  
 Sensitivity: 1,000 g (2 lb) Warranty: 2 years

## GIMA BATHROOM DIGITAL SCALES



27248

- **27248 DIGITAL GLASS SCALE - black**
- **27249 DIGITAL GLASS SCALE - grey**  
 Electronic bathroom scale with 6 mm thick tempered glass platform. Ultra slim design: only 19 mm height. 4 high precision G sensors. Automatic on and off function. Lb/kg/st switchable by user.

Multilingual colour box and manual:  
 GB, FR, IT, ES, DE, PL, PT, GR, Arabic

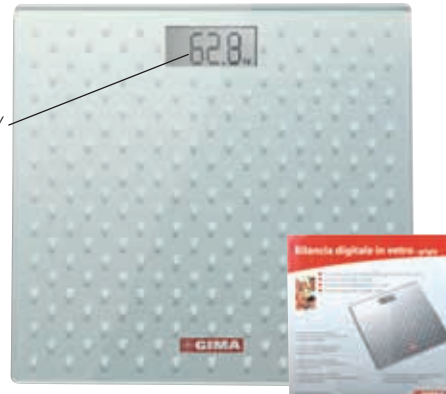

27249

### TECHNICAL SPECIFICATIONS

Capacity: max 150 kg (330 lb)  
 min. 2 kg (4.4 lb)  
 Sensitivity: 100 g (0.2 lb)  
 Dimension: 300x300x19 mm  
 Power: 1xCR2032 lithium battery - not included  
 Warranty: 2 years

## EXACTA BODY FAT SCALE



Multilingual manual and box:  
 GB, FR, IT, ES, PT, DE, PL, NL, HU, GR, CZ, HR, DK, SE, FI, SI, TR, RU.

27229

UP TO 180 kg



- **27229 EXACTA DELUXE BODY FAT SCALE**  
 Measuring body weight, fat, water, muscle content and daily caloric consumption. Sensor touch. Easy to read LCD display. Large platform made of safety glass. 8 user memories. Kg/lb/st switch. Auto ON/OFF function.

### TECHNICAL SPECIFICATIONS

Capacity: max 180 kg (400 lb, 28 st) min 3 kg (6.6 lb)  
 Size: 310x310x22 mm  
 Battery: 2x CR2032 - included

Sensitivity: 100 g (0.2 lb)  
 LCD Display: 31 mm  
 Warranty: 3 years

## OMRON DIGITAL SCALE



27087

UP TO 180 kg



- **27087 OMRON HN286 DIGITAL SCALE**  
 Electronic bathroom scale with four integrated sensors for fast and reliable reading, up to 180 kg. Automatic shutdown after 6 seconds. Switch on by contact on the tray. Multilingual manual in all European languages and NO, TR, RU, Arabic.

### TECHNICAL SPECIFICATIONS

Capacity: 5 to 180 kg  
 Power: CR2032 lithium battery - included  
 Size: 300x300x18 mm

Sensitivity: 100 g  
 Weight: 1.9 kg

## SECA MECHANICAL SCALES



27241

### TECHNICAL SPECIFICATIONS

Capacity: 150 kg - 330 lbs  
 Size: 317x117x477 mm  
 Sensitivity: 1 kg  
 Weight: 3.5 kg

• **27241 SECA 750 SCALE**  
 Mechanical flat scale with sturdy, powder coated steel casing. Pretty and stable with its white powder coated lacquer. A hard wearing synthetic white leather covers weighing platform.  
 User manual in: GB, FR, IT, ES, DE, PT, PL.



• **27280 SECA 761 SCALE - medical use - Class III**  
 • **27285 SECA 762 SCALE**  
 Traditional model with large easy-to-read dial. Pointer professional scale in strong metal structure white painted. Consistent accuracy on any surface. Spacious and stable platform with no slip rubber mat. Tare function.  
 User manual in: GB, FR, IT, ES, DE, PT, PL.



27280

### TECHNICAL SPECIFICATIONS

Capacity: 150 kg - 330 lbs  
 Sensitivity: 500 g ± 2 g (27285) - 1,000 g (27280)  
 Size: 305x120x470 mm  
 Weight: 3.5 kg

MEDICAL USE

## SECA DIGITAL SCALES

### • 27265 SECA 813 DIGITAL FLAT SCALE

Electronic scale with high capacity up to 200 kg. Extra-wide platform and flat shape facilitate weighing of heavyweight patients and make stepping on very easy. Made of solid steel frame with tough rubber coating and non-slip rubber base, ensuring safety and stability. Kg/lbs/sts switch. Auto-hold, step-off and automatic switch ON/OFF functions. Multilingual manual: GB, FR, IT, ES, PT, DE, PL, NL, GR, DK, SE, FI, NO, TR, JP, RU.



27265

UP TO 200 KG



**TECHNICAL SPECIFICATIONS**  
 Capacity: 200 kg - 440 lbs  
 Size: 433x373xh 47 mm  
 Weight: 2,9 kg  
 Sensitivity: 100 g - 0,2 lbs  
 Platform size: 400x300xh 45 mm  
 Batteries: 4xAAA 1,5V (not included)

### • 27257 SECA 807 DIGITAL SCALE

Digital scale with advanced technology for enhanced comfort. Extra-flat design to easily step onto the platform. Four specially constructed load cells made of stainless steel, guarantee high precision. Supplied with power sensors, extra-large LCD numbers and high-quality glass surface. Safety shock resistant glass construction. Step-off, auto-hold and automatic switch ON/OFF functions. Multilingual manual: GB, FR, IT, ES, PT, DE, PL, NL, GR, DK, SE, FI, NO, TR, JP, RU.



27257

**TECHNICAL SPECIFICATIONS**  
 Capacity: 150 kg  
 Size: 310x310xh 37 mm  
 Batteries: 4xAAA 1,5V (not included)  
 Sensitivity: 100 g  
 Weight: 2 kg

## iHEALTH FIT BODY ANALYSIS SCALE



iHealth MyVitals

See the list of compatible devices on [ihealthlabs.eu/support](http://ihealthlabs.eu/support)



23503

### • 23503 iHEALTH FIT HS2S WIRELESS BODY ANALYSIS SCALE

Weight and body composition monitoring on iPhone, iPad and Android smartphone.  
 - light and compact body analysis scale  
 - measures weight, BMI (Body Mass Index), lean, bone, muscle, water mass, body fat, daily caloric intake and visceral fat rating  
 - luminous LED display - 8 users  
 - track data, graphs and history on the iHealth MyVitals App  
 - store up to 500 measurements per user before synchronization  
 - share your medical data with your healthcare professional Bluetooth Sync, easy to install. Secure and free data storage.

### TECHNICAL SPECIFICATIONS

Connectivity: Bluetooth 4.0  
 Dimensions - weight: 306x306x26.6 mm - 1,850 g  
 Battery: 4 AAA batteries 1.5 V (included)  
 Range - sensitivity:  
 - weight 5-180 kg (11-400 lb) - ±1%  
 - body fat 5%-65% ±1%

## GIMAFIT BLUETOOTH SCALE

• **27086 GIMAFIT BODY SCALE with Bluetooth 5.0**  
 Multifunction scale, for measuring body fat, water, muscle and bone rate and mass (BMI, BMR). Equipped with 4 precision G sensors. Platform material: glass + stainless steel. Domestic use.



**TECHNICAL SPECIFICATIONS**  
 Capacity: 180 kg / 396 lb - minimum 0.15 kg  
 Sensitivity: 200 g / 0.4 lb (>50 kg <100 kg)  
 Size: 300x300x23 mm  
 LED display: 80x40 mm white light  
 Batteries 4xAAA (included)  
 Switchable kg/lb

Multilingual manual in: GB, FR, IT, ES, PT, DE, PL, GR.



0.15-180 kg

27086

## SOEHNLE DIGITAL SCALES

• 27275 SOEHNLE 7830  
 • 27276 SOEHNLE 7831 with height rod and BMI display  
 Professional personal scales with stand and gently curved glass indicator. While stepping on the scale, the display is activated automatically and the weight is shown with red backlighted numbers. It does not require any operation and is suitable for medical institutions, wellness areas and pharmacies.

Scale with integrated height rod Soehnle 7831 (27276) with stand and height rod switches automatically from kg to cm if the height rod is raised. Patients can be simultaneously weighed and measured.

Features:

- indication of weight, height and BMI (27276 only)
- integrated height rod from 120 cm to 202 cm (27276 only)
- easy to use, tare key on the back of the display
- glass scale indicator (glass thickness 8 mm)
- bright LED display: 5 digits, height 15 mm

MADE IN GERMANY

**SOEHNLE**  
PROFESSIONAL

### TECHNICAL SPECIFICATIONS

	27275	27276
Capacity:	250 kg	250 kg
Sensitivity:	100 g	100 g
Dimension mm:	365x490x890	365x490x1,280
Weight:	14.1 kg	17.2 kg
Power Supply:	230 V - 50-60 Hz (available on request 110 V)	



No keys on the glass plate

Multilingual manual in: DE, GB, FR, ES, IT, NL, DK, FI, SE, NO, GR, TR, CZ, SK, PL, RU.

## CHAIR SCALE

• 27273 CHAIR SCALE SOEHNLE 7802  
 Fully electronic scale: no wear and tear parts, no maintenance. Easy to read display with 20 mm high figures. Zero setting, taring and hold functions. Tiltable arms for easy access of bed-ridden and frail patients. Powered by either mains or rechargeable batteries. Cable for recharging batteries included.

Manual in: DE, GB, FR, NL, ES, IT, PT, CZ, FI, SE, NO, DK, GR, PL, TR.



MADE IN GERMANY

**SOEHNLE**

### TECHNICAL SPECIFICATIONS

Capacity:	200 kg (440 lb)
Sensitivity:	100 g
Total weight:	25 kg
Dimensions:	580x1,100x930 mm
Power supply:	230 V / 50-60 Hz, 10 mA, 2.2 VA
	Rechargeable batteries



## SECA MEDICAL SCALES - CLASS III

CE 0123  
Class III



Dial with BMI



27284

• 27284 SECA 756 - mechanical with height rod - (60-200 cm) - class III  
 Tradition combined with modern design. With a very sensitive precision mechanism to show weight through the aid of a well visible red pointer on the circular dial.  
 User manual in GB, FR, IT, ES, DE, PT, PL, NL, GR, DK, SE, FI, NO.

### TECHNICAL SPECIFICATIONS

Capacity:	160 kg
Sensitivity:	500 g
Weight:	18.5 kg
Dimensions:	628x360x1,000 mm
Platform:	360x350 mm with wheels

Keys to symbols: M = Metrological Approval for use in medical field

CE = Calibration according to class III sensitivity required by 90/384/EEC

CE 0123  
Class III

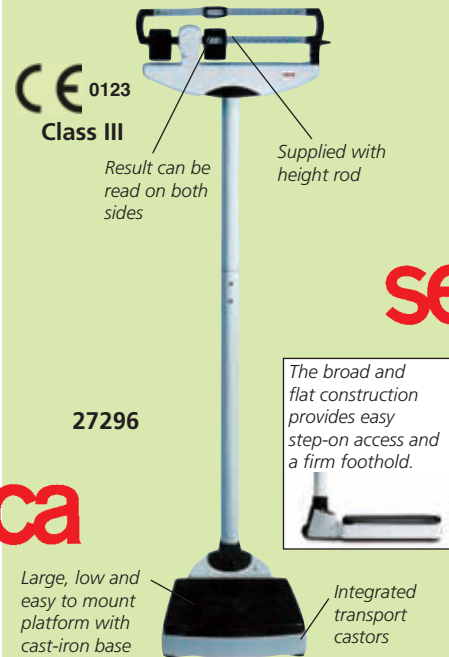

27296

Large, low and easy to mount platform with cast-iron base

The broad and flat construction provides easy step-on access and a firm foothold.



Integrated transport castors

### MECHANICAL SCALES WITH HEIGHT ROD

- 27296 SECA 711 - class III
- 27295 SECA 700 - kg/lbs
- 27297 SECA 700 - kg

Mechanical column scale with weight adjustment at eye level. Weight can be measured in a conventional way: by aligning two chrome plated indicators. User manual in GB, FR, IT, ES, DE, PT, PL, NL, GR, DK, SE, FI, NO.

• 27298 SECA 220 HEIGHT ROD - spare  
 Measure range: 60-200 mm Division: 1 mm.

### TECHNICAL SPECIFICATIONS

Capacity:	220 kg (27296-7), 160 kg/400 lbs (27295)
Sensitivity:	100 g (27296) - 50 g (27297) 100 g / 1.4 lbs (27295)
Dimensions:	520x1,556x520 mm
Platform:	335x80x345 mm
Weight:	16.5 kg

CE 0123  
Class III



27292

The non slip surface on the platform guarantees a safe and secure foothold

All it takes is the press of a key to find out BMI

27292 + 27298

• 27292 SECA 799 - electronic with BMI - class III  
 • 27298 SECA 220 HEIGHT ROD - optional  
 Versatile, low maintenance and site independent with economic battery operation, ideal for daily use in hospital and doctors practices. Column scale is easy to move around with its transport castors. BMI function permits a reliable evaluation of the nutritional conditions of the patient. Equipped with several functions: TARE, HOLD, weighing range switch-over, automatic switch off. User manual in GB, FR, IT, ES, DE, PT, PL, NL, GR, DK, SE, FI, NO.

### TECHNICAL SPECIFICATIONS

Capacity:	200 kg
Sensitivity:	100 g < 150 kg > 200 g
Weight:	6.3 kg
Dimensions:	294x831x417 mm
Platform:	272x280 mm

## PEGASO DIGITAL SCALE



Anodized aluminium telescopic height rod cm-inches with measurement range 80-210 cm and graduation of 0.5 cm

Switchable kg/lb.



- **27289 PEGASO DIGITAL SCALE with height meter (80x210 cm)** Reliable digital scale with integrated height rod. Easy to use, each function has an on-screen display to track activities in real time. High contrast backlit LCD display with 20 mm figures for increased readability. Exact and reliable results thanks to tare and fixed weight functions. Not Medical device. Auto-off function to avoid energy waste. Can be operated by mains or batteries.
- **27281 POWER SUPPLIER - spare**

### TECHNICAL SPECIFICATIONS

Capacity:	200 kg
Sensitivity:	100 g
Power supply:	110-240 V - 50/60 Hz
Battery accumulator:	6V 5AH
Recharging time:	4-5 hours
Operating time when fully charged:	36 hours
Package size:	1000x320x260 mm
Dimensions - Weight:	535x275x960 mm - 12 kg



27289

Platform: 375x275 mm

## ASTRA SCALE



Reading on both sides of measuring rod 75 to 200 cm



- **27310 ASTRA SCALE - 200 kg - Class III accuracy mechanical with height meter (75-200 cm)** Sturdy and reliable beam scale to warrant exact and precise measurements. Made of steel and varnished in high resistance white matte finish. Robust lever system. Provided with wheels for easy mobility. NAWI certificate, Class III accuracy. User manual in GB, ES, FR, IT, DE, GR, PT, Arabic.

### TECHNICAL SPECIFICATIONS

Capacity:	200 kg
Sensitivity:	100 g
Weight:	15.3 kg
Dimensions:	435x1,485x565 mm
Platform:	375x275 mm
Package size:	1490x495x155 mm

Wheels for easy mobility

Platform with anti-skid cover



27310

## MULTIFUNCTION SCALE

- **27243 MULTIFUNCTION SCALE - SOEHNLE 7808** Manual in: DE, GB, FR, NL, ES, IT, GR, FI, NO, SE, DK, CZ, RU.
- **27244 DRIVE-ON RAMP**
- **27245 ADIPOSITIVITY HANDRAILS + BRACKET FOR INDICATOR**
- **27251 SUPPORT HANDRAILS + BRACKET FOR INDICATOR**
- **27278 MULTIFUNCTION SCALE - SOEHNLE 7708** (CE Class III (complete with 27244+27251)) - manual in: GB, FR, DE Multifunction scale prepared for easy (and later) mounting of support handrails, adiposity handrails, bracket for indicator, drive-on ramps. Movable by means of 2 rollers and handle.

**SOEHNLE**  
PROFESSIONAL

Large LCD display, digit height 20 mm.

Bracket for indicator



Multifunction scale with 3 handrails, a drive-on ramp and indicator bracket

Support handrails

27243  
+  
27244  
+  
27251

27243+27245

MADE IN GERMANY

### TECHNICAL SPECIFICATIONS

Capacity:	300 kg	Sensitivity:	100 g
Dimension:	840x880x55 mm	Weight:	16 kg
Power supply:	rechargeable battery with charger (on request power supply 230V - 50-60 Hz)		

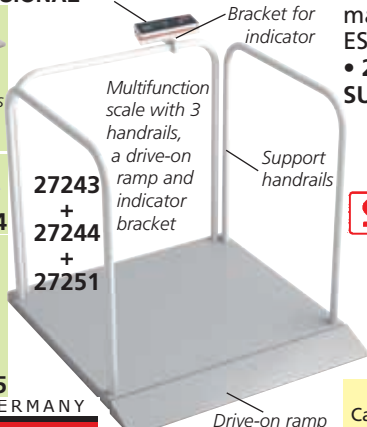

Drive-on ramp

## SCALE WITH HANDRAIL

- **27279 SOEHNLE 6831 DIGITAL SCALE with handrail and height rod (60-212 cm)** Powder-coated platform with integrated support railing for a safe stand. Extendable aluminium height rod. Large LCD display with digit height 25.4 mm. 4 leveling feet to stabilize the scale. 4 functions: BMI weighing, taring and hold. Energy saving auto off function. Multilingual manual: GB, FR, IT, ES, DE.
- **27274 POWER SUPPLY - optional**

**SOEHNLE**  
PROFESSIONAL



MAX  
LOAD  
300 kg

27279

### TECHNICAL SPECIFICATIONS

Capacity:	300 kg	Sensitivity:	100 g
Weight:	28 kg	Measuring range:	60-212 cm
Dimensions:	520x520x1,265 mm		
Platform:	520x520 mm		
Battery:	4x 1.5V AA (included)		



## SIRIO SCALE

- **27305 SIRIO SCALE - 150 kg mechanical with height meter (85-210 cm)** Sturdy and reliable dial scale to warrant exact and precise measurements. Large dial for easy reading. User manual in GB, FR, IT, ES, PT, DE, GR, Arabic.

Aluminium rod, height range 85 to 210 cm (division 1 mm)



### TECHNICAL SPECIFICATIONS

Capacity:	150 kg
Sensitivity:	500 g
Weight:	13 kg
Platform:	370x270 mm
Dimensions:	680x275x1,080 mm
Package size:	106x34x29 cm

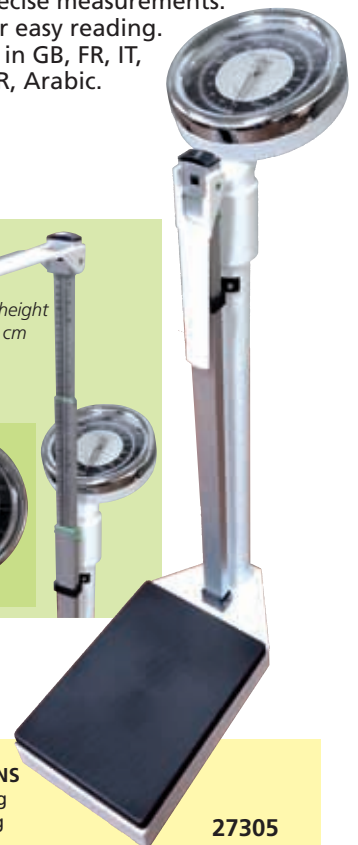

27305

## MANUAL AND ELECTRIC LICE COMB

Natural, ecologic method to eliminate completely lice and nits without any harm. Ideal for allergy sufferers and children.

### • 24400 MANUAL LICE COMB - blister

Ergonomic comb with long metal teeth and a detachable cleaning brush with built-in magnifier. The long, delicately closed teeth of the comb are designed specifically to detach lice and their nits (tiny eggs).

The round form of the touching point respects the growth direction of the hair without harming its texture.

Multilingual blister: GB, FR, IT, ES.

Free display box any 10 blister



24400

Detachable cleaning brush with built-in magnifier



24400

### • 24403 ELECTRIC LICE COMB - IT, ES

### • 24405 ELECTRIC LICE COMB - GB, FR

This innovative product eradicates and kills lice and nits with a quick increasing electrical discharge of 100-250 Volts from the teeth, imperceptible and harmless to humans. Auto switch off. Provided of buzzer indicator and LED light. Supplied with cleaning brush, 1 AAA battery, multilingual manual in a multilingual blister.



24403, 24405

Size:

10.36x7.57x2.66 cm

## DEVICES AGAINST INSECTS

25771 0051

- 25770 ZANZA-CLICK AFTERBITE - IT - green
- 25771 ZANZA-CLICK AFTERBITE - GB - blue

A few clicks to soothe the irritation caused by mosquito bite and nettles.

- 25772 BABYFRIEND Ultrasonic repelling device against mosquitos. Suitable for a 15 m<sup>2</sup> room.

## UNSTINGER®

- 24395 UNSTINGER® Insect poison extraction tool. An easy and painless way to avoid the discomfort that follows from bites and stings by bees, wasps, hornets and even scorpions or snakes. Reusable one-hand operated vacuum pump which easily and painlessly extracts poison and venom from a sting or bite. Multilingual box and manual: GB, FR, IT, ES.



## TICK TWEEZER

• 24390 TICK TWEEZER - 8,5 cm Intended for holding and removal purpose. Made of stainless steel.

## SPLINTER

• 24391 SPLINTER WITH MAGNIFYING GLASS 2X - 8 cm Magnifying glass splinter tweezer made of stainless steel.

## DENTAL HYGIENE

36655

- 36655 GERMORAL MOUTHWASH - bactericidal mouthwash One display contains 12 bottles of 300 ml

For daily oral hygiene, Germoral prevents and acts against the formation of bad breath because it stops fermentation in the oral cavity. It performs an antiplaque and hygienic action. Suitable for smokers, prothesis or paradontic teeth users or after dental surgery for disinfecting the oral cavity. If regularly applied it prevents and acts against inflammations, gingival disorders, dental plaque formation.

## ECOSAVE FOR POISONOUS BITES

- 25773 ECOSAVE AGAINST POISONOUS BITES Pocket-size electronic device that produces - through two electrodes - high-voltage and low-amperage discharges with effectiveness against snakes venomous bites, insects venomous stings (bees, wasps, bumble-bees...), arachnidan (scorpions, spiders...) and marine animals (greater weeviers, jellyfishes, urticant coral) poisonous bites. It can be used against viper's bites, whose poison acts locally through the blood as an hemocytotoxic agent. It is not effective against neurotoxic venom, like the cobra's one, which spreads through nerve fibres. It is a first aid tool; in more severe cases (allergic subjects or snake bites), doctor or hospital assistance is needed after treatment. Its use can also be extended to dogs.



ELECTRIC STIMULATION TO REDUCE POISONOUS BITES EFFECTS

# VISIOFOCUS® AND VISIOFOCUS® PRO "NON CONTACT" THERMOMETERS



VisioFocus® is the most advanced thermometer to precisely measure body temperature. Totally hygienic, **without touching the skin**, VisioFocus® reads infrared radiation naturally emitted by the surface of the skin and calculates the whole body temperature



MADE IN ITALY

• 25573 VISIOFOCUS®

• 25574 VISIOFOCUS® PRO

High accurate "non contact" thermometer that projects the temperature on the forehead.

**Advantages of VisioFocus®:**

- exclusive patented aiming system guarantees correct point and distance
- projection of the temperature on the forehead
- face button automatically adjusts forehead temperature to the environment (room) temperature for accurate result
- exclusive and patented AQCS and MQCS systems to maintain correct and constant temperature of device during long periods of use or when moving between rooms with different temperatures
- clinically tested
- totally hygienic for patients and users: no touch, no disposables
- no laser: absolutely safe for travellers and users, no harm if the person eyes are open while measurement is taken
- instantaneous: gives temperature in less than 1 second
- Nurs and Doct functions (only 25574) for pandemic situations: allow to take temperature of up to 1,000 travellers per hour. Nurs has obliged MQCS every 30 minutes, Doct has automatic AQCS



25573

- low using cost thanks to the long battery life and speed of measurement that allows to reduce the number of thermometers and of operators necessary for a wide screening



25573

Visiofocus® is supplied with batteries and manual (GB, FR, IT, ES)



25574

Visiofocus® Pro is supplied in a case with lanyard, batteries and manual (GB, FR, IT, ES)

BACKLIGHTED DISPLAY IN 5 DIFFERENT COLOURS, ONE FOR EACH FUNCTION

BODY TEMPERATURE	OBJECTS	MEMORY	AMBIENT	CALIBRATION MQCS

### TECHNICAL SPECIFICATIONS

Forehead measuring range	34.0 / 42.5°C (93.2/108.5°F)
Measuring range (apart from forehead)	1.0/80°C (33.8/ 176°F)
Room temperature working range	16/40°C (60.8/104°F)
<i>Can work also in environments with a temperature between 10 and 16°C (50/60.8°F) and between 40 and 45°C (104/113°F) but in this case the accuracy is reduced</i>	
Resolution	0.1°
Accuracy level	According to ASTM E 1965-98:2016
Distance of operation:	About 6 cm (2.36")
Batteries (included)	4 AAA/LR03 type (preferably alkaline)
Batteries life	<30,000 measurement
Measurement time	<0.5 seconds
Time between consecutive measurements	<2 seconds

# RI-THERMO® SENSIOPRO NON CONTACT INFRARED THERMOMETER



LCD Backlight display for low light situations

Unique high-performance sensor technology

Single button operation



25540



Memory recall, 30 measurements

Switchable from Celsius to Fahrenheit

• 25540 RI-THERMO SENSIOPRO NON-CONTACT INFRARED THERMOMETER

Contactless, accurate and fast thermometer, helping minimize cross contamination. Clinical grade forehead temperature measurements, calibrated to an oral body temperature reference. Optimized for professional.

**Features:**

- clinical grade reading in 1-2 seconds
  - ISO standards 80601-2-56:2017
  - safe and efficient
  - infrared non-contact helps preventing cross contamination
  - 3000 measurements on one set of batteries
  - 30 measurement storage
  - backlit LED screen
  - single hand operation
- Multilingual manual: GB, FR, IT, ES, DE, RU.

### TECHNICAL SPECIFICATIONS

Measurement range:	Forehead: 22 - 44°C
Accuracy:	Forehead: 36 - 39°C ±0.2°C, < 36°C or > 39°C
Operating Temperature:	10 to 40°C (50 to 104°F), 95% RH or less
Resolution:	0.1°C / 0.1°F
Measurement Unit:	°C (Default) / °F
Hi/Lo Indicator:	34 to 43°C (93,2 to 109°F)
Power Source:	Two 1.5 V AA Batteries (non-rechargeable)
Battery Life:	Approximately 3000 measurements
Memory Capacity:	Allows memory recall, 30 previous measurements
Power saving:	Automatic power off after 30 seconds
Measuring distance:	Approx. 3 - 7 cm
Dimension / Weight:	150 (L) x 48.5 (W) x 55 (H) mm / 125.8 g (with battery)
Standards:	ASTM E1965-98 and EC directive 93 / 42 / EEC



## OMRON GENTLE TEMP® 720

• 25611 OMRON GENTLE TEMP® 720 NON CONTACT THERMOMETER

Gentle Temp® 720 is a superfast accurate infrared non contact thermometer. It is intended to measure body, surface and room temperature. It can memorise up to 25 readings, track temperature changes over a period of time and monitor trends. In addition to the forehead mode, it can also be switched to surface measurement mode, which shows the actual and unadjusted surface temperature. It helps to determine if the object temperature (for example a milk bottle or food dispenser) is suitable for the patient or the baby. Room temperature is always displayed. It is intended for home use. Reading scale °C/°F is switchable. Supplied with 1 battery, probe cap and multilingual instructions manual: GB, FR, IT, ES, DE, NL, RU, TR, Arabic.



25611



3 APPLICATIONS:  
FOREHEAD, SURFACE, ROOM

### TECHNICAL SPECIFICATIONS

Measurement type:	contactless 3 in 1 (forehead, surface, room)
Measurement range/accuracy:	forehead 34.0 - 42.2°C (93.2-108.0°F) / ± 0.2°C surface -22.0 - 80.0°C (-7.6° - 176.0°F) / ± 0.3°C room 10 - 40°C (50°-104°F) / ± 2°C
Auto power off time:	1 min
Measuring time:	1 second
Measuring distance:	1-3 cm (0.4-1.2 inch)
Temperature mode:	°C/°F
Memory:	25 readings
Display:	backlight
Battery:	3.0V DC, 1 CR2032 (code 32212) lithium button battery battery life: approx. 2,500 measurements
Classification - protection:	Type BF - IP22
Size - weight:	155x39x45 mm - 90g

## GIMATEMP NON CONTACT THERMOMETER

• 25583 GIMATEMP NON CONTACT THERMOMETER GB, FR, IT, ES

• 25584 GIMATEMP NON CONTACT THERMOMETER IT, DE, PT, SE

Multifunctional infrared non contact thermometer with 4 applications: body, liquid, food, ambient temperature.

- high accuracy and quick measurement in ≤2-3 sec
- 3 colour backlight alarm (red, yellow, green) for checking the temperature status
- measuring distance 1-5 cm
- room temperature is always displayed.
- 50 memories

THREE-COLOUR BACKLIGHT ALARM

**NORMAL**  
35.5-37.3°C (95.9-99.1°F)

**SLIGHT FEVER**  
37.4-38.0°C (99.3-100.4°F)

**HIGH FEVER**  
38.1-43.0°C (100.6-109.4°F)



25583

4 APPLICATIONS:  
BODY, LIQUID, FOOD,  
AMBIENT TEMPERATURE

### TECHNICAL SPECIFICATIONS

Measurement method:	Temporal artery scan or forehead spot
Display model - resolution:	°C/°F - 0.1°C/0.1°F
Operating mode:	Adjusted mode (Body mode) Direct mode (Surface mode) Body mode: 34.0-43.0°C/93.2-109.4°F Surface mode: 0-100°C/32-212°F
Output range:	Body mode: 35.0-42.0°C ±0.2°C / 95.0-107.6°F ±0.4°F ±0.3°C/±0.5°F for other range
Accuracy:	Surface mode: ±2°C/±3.6°F
Auto power off time:	≤18 s
Measuring time:	2-3 s
Measuring distance:	1-5 cm (0.4-2 inch)
Batteries (included):	1.5 V (AAA) alkaline batteryX2 (IEC type LR03)
Size - Weight:	122x96x42 mm - 80 g

## INFRARED NON CONTACT THERMOMETERS FOR BODY AND OBJECTS

• 25591 INFRARED NON CONTACT THERMOMETER

Multifunctional infrared non contact thermometer for body and objects.

Effective distance 2.5 cm.

**Body temperature with fever teller**  
Wide range 32.0-42.9 °C (89.6-109 °F)

and green, yellow, red backlight.

**Object temperature 0-100 °C (32-212 °F)**

Body object function for ambient temperature, milk or bath surface temperature.

**Fever alarm**

**32 memories**

**Instant response time: 1 second**

Auto/manual power off.

Supplied with 2AA batteries.

Size 160x95x46 mm.

Display 30x31 mm.

Reading scale °C/°F switchable

Multilingual box and manual: GB, FR, IT, ES.



**FEVER TELLER**



Green backlight  
from 32° to 37.5



Yellow backlight  
from 37.6° to 37.9



Red backlight  
from 38° to 42.9°



• 25582 A200 INFRARED NON CONTACT THERMOMETER - GB, FR, IT, ES

• 25590 A200 INFRARED NON CONTACT THERMOMETER - IT, GR, RO, PL

Multifunctional infrared non contact thermometer for body and objects.

Effective distance 2-3 cm.

- result in 1 second

- LCD backlight display

- quality sensor for high accuracy measure

- °C and °F are easily convertible

- 3 colours screen red, orange and green

indicate temperature level

- automatically power off after 30s if left it on still

- 25 groups memories

- audible alarm

- low power warning

Supplied with multilingual box and manual (GB, FR, IT, ES or IT, GR, PL, RO) and batteries.

CE 0123



Body or  
objects  
switch



25582  
25590

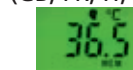

Green backlight  
< 37.5°C (99.5 °F)

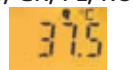

Orange backlight  
≥ 37.5°C ≤ 37.9°C  
(≥99.5°F ≤100.2°F)

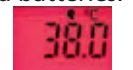

Red backlight  
≥ 38.0°C (≥100.4 °F)

### TECHNICAL SPECIFICATIONS

Measurement Range:	Body 32 - 42.9°C (89.6 - 109.3 °F) ±0.2 °C Objects 0-99°C (32.0-211.82 °F)
Response time:	1 second
Memory:	25 groups
Display Mode:	°C/°F
Battery Type:	2 AAA 1.5V
Dimension (LxWxH) - Weight:	168x54x44 mm - 75 g



## OMRON GENTLE TEMP® 520

### • 25610 OMRON GENTLE TEMP® 520 INFRARED EAR THERMOMETER

Gentle Temp® 520 infrared thermometer offers comfortable, safe, accurate and quick temperature measurement from the eardrum. It offers advanced features: one-second measurement and a memory for up to nine readings to track temperature changes over a period of time and monitor trends. It is intended for home use. Large LCD display. Switchable reading scale °C/°F. It can measure consecutively up to 3 times. Supplied with 1 battery, 21 probe covers, probe cap, connection ring and multilingual instructions (GB, FR, IT, ES, DE, NL, RU, TR, Arabic).



25610



#### TECHNICAL SPECIFICATIONS

Measurement range:	34.0-42.2°C (93.2-108.0°F)
Accuracy:	± 0.2°C (± 0.4°F)
Measurement time:	1 second
Temperature mode:	°C/°F switchable
Auto power off time:	1 min
Memory:	9 readings
Display:	LCD display
Battery:	3.0V DC, 1 CR2032 (Gima code 32212) lithium button battery
Battery life:	approx. 2,500 measurements
Size - weight:	161x36x56 mm - 85g
Classification - protection:	Type BF - IP22

## SMARTEMP WIRELESS THERMOMETER

### • 25615 SMARTEMP WIRELESS INFRARED FOREHEAD AND EAR THERMOMETER

Multifunctional infrared thermometer used to read body (ear and forehead) and object temperature.

- clinically accurate, reliable and quick
- professional and home use
- patent technology to separately measure adults and children
- four colour LED backlight
- 10 memory records
- switchable between °C and °F
- audio and visual fever warning
- magnetic probe cover to automatically switch between forehead and ear mode

Wireless connection to mobile devices, downloading free Vihealth App. Supplied with pouch, 2 AAA batteries, multilingual manual: GB, FR, IT, ES, DE.

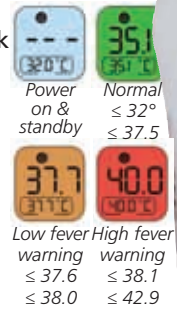

3 APPLICATIONS: FOREHEAD, EAR, OBJECT



25615

#### TECHNICAL SPECIFICATIONS

Measurement type:	3 in 1 (forehead, ear, object, liquid)
Measurement range/accuracy:	forehead & ear 32.0-42.9°C ± 0.2°C object 0 -100°C / ± 1.0°C
Auto power off time:	1 min
Measuring time:	1 second
Temperature mode:	°C/°F switchable
Memory:	10 groups
Display:	LCD, four-colour LED display (white, green, orange, red) Resolution: 0.1 °C/°F
Battery:	3V DC 2xAAA batteries, can be used more than 3000 times
Size - weight:	143x35x41 mm - 80g (with batteries)
Classification - protection:	Type BF - IP22



## EAR THERMOMETER

- 25580 IR EAR THERMOMETER
- 25581 PROBE COVERS - box of 40 pcs.
- 32212 SPARE BATTERY

- fully meet "ASTM" standard and CE EN 12470-5 (only few brands passed it) in measurement accuracy (35.5 °C to 42 °C ± 0.2 °C, others ± 0.3 °C).

- unique and handy design
- one-second measurement, fast and easy
- 9 memory for temperature comparison and evaluation, fever alarm, easy reading LCD display
- self-diagnostic and infrared measurement



25581

25580

#### TECHNICAL SPECIFICATIONS

Measurement Range:	34.0 °C~42.2 °C (93.2 °F~108.0 °F)
Response time:	1 second
Time between measurements:	> 5 sec
Display Model	°C/°F
Battery Type:	CR2032 (32212)
Dimension (LxWxH) - Weight:	14x3.8x3 cm - 70 g
Norms:	IEC60601-1, IEC60601-1-2 (EMC), ASTM E1965-98



## PROFESSIONAL THERMOMETER

- 25575 PROFESSIONAL INFRARED EAR THERMOMETER
- 25576 PROBE COVERS - box of 200 pcs. (5 tubes of 40 pcs.)
- 25577 PROBE COVERS LOADER with 40 PROBE COVERS

HOSPITAL USE

- special design for hospital use

- durable probe for cover replacement up to 100,000 times
- probe cover ejector and probe cover detector
- one-second response time: fast and easy
- neck strap and 1 probe cover included
- fever alarm
- selectable °C/°F

Needs probe covers for use

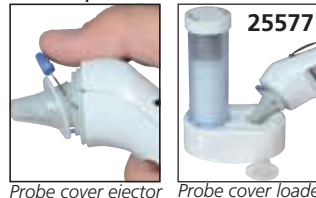

Probe cover ejector

Probe cover loader

Large LCD display

25575

#### TECHNICAL SPECIFICATIONS

Measurement range:	34~42.2 °C (93.2-108 °F)
Accuracy:	±0.2 °C (0.4 °F) during 35.5~42 °C (95.9~107.6 °F), ±0.3 °C (0.5 °F) for other range
Memory:	25 sets
Buzzer:	Yes
Battery:	CR2032 1 (Gima code 32212)
Dimension - weight:	144.82x39.84x48.50 mm - 68.8 g



## POCKET EAR THERMOMETER

### • 25579 POCKET EAR THERMOMETER

Small, easy to clean, cover free design ear thermometer. Home use.

#### TECHNICAL SPECIFICATIONS

Measurement Range:	34-44 °C (93.2-111.2 °F) ± 0.2 °C (± 0.4 °F)
Response time:	1-2 seconds
Battery:	Lithium 3 V (CR2032) - life approx 4,000 measurements
Size - weight:	114x35x40 mm - 35 g (including batteries)

25579

Multilingual box and instructions: GB, FR, IT, ES.



Easy to read 3 digit LCD display 27.9x13 mm

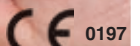

## ECOLOGICAL THERMOMETERS - MERCURY FREE

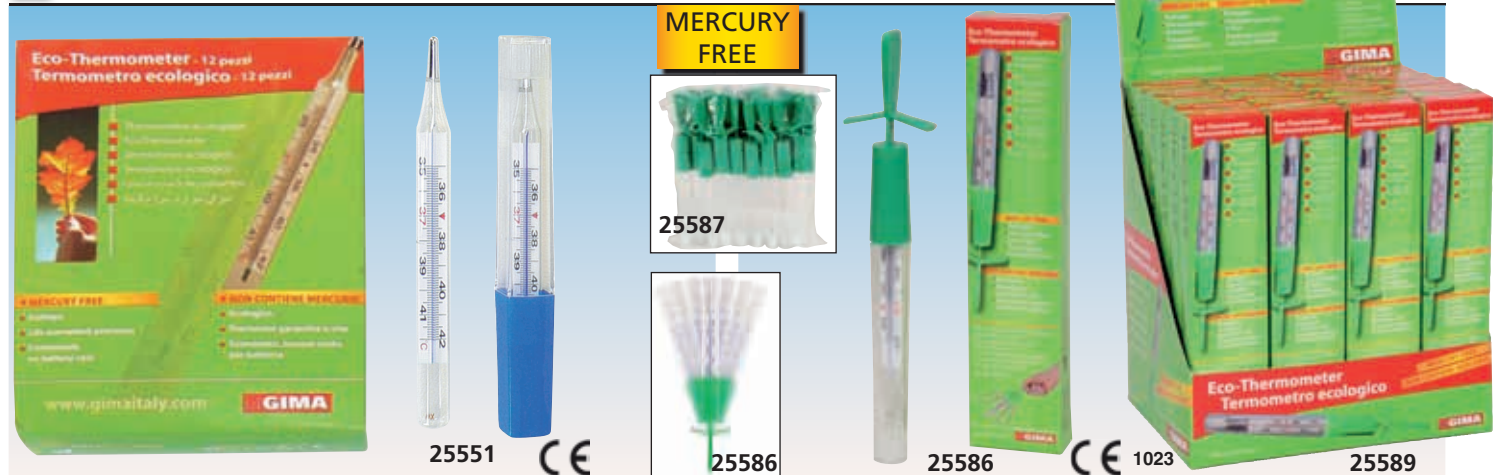

- 25551 ECOLOGICAL OVAL THERMOMETER - box of 12
- 25587 SHAKER for ecological thermometers - box of 24

Mercury free clinical thermometer with gallium alloy instead of mercury. Safe, precise and functional. Glass structure. Multilingual box and instructions: GB, FR, IT, ES, PT, DE, PL, RO, SK, GR, Arabic.

- 25586 ECOLOGICAL OVAL THERMOMETER with shaker - box of 1
- 25589 ECOLOGICAL OVAL THERMOMETER with shaker - display box of 24 pcs.

Same as 25551 but supplied with a shaker to help shake down gallium after use.

## WIRELESS THERMOMETER BLUETOOTH 4.0

- 25548 TEMP SITTER - baby wireless thermometer

Accurate and innovative thin thermometer. Transmission to Temp Sitter App (iOS, Android). To be placed under baby armpit. Update frequency every 3 seconds. High temp alarm can be set in the App. Waterproof and material of safe quality. Supplied with 10 adhesives to fix thermometer to baby armpit, manual (GB, FR, IT, ES).



**25548**

**TECHNICAL SPECIFICATIONS**  
 Battery life: 3,000 hours, not replaceable  
 Measurement range: 25-45 °C (±0.05 between 35-38.5 °C)  
 Size: 51x31.8x8.5 mm - Weight: 9.6 g - Switchable °C/°F

**CE 0123**

## OMRON DIGITAL THERMOMETERS

- 25603 ECO TEMP BASIC THERMOMETER - MC 246-E
- 25604 FLEX TEMP SMART THERMOMETER - MC 343F-E



Model	TECHNICAL SPECIFICATIONS	
	25603 (Eco Basic)	25604 (Flex Smart)
Measurement Type	Oral, Armpit, Rectal	Oral, Armpit, Rectal
Flexible tip		•
Beeper (signals when a measurement is complete)	•	•
Memory	last reading	last reading
°C/°F selection	•	•
Large, 3 digit display	•	•
Water resistant	•	•
Automatic shut off	•	•

## LIQUID CRYSTAL FOREHEAD THERMOMETERS

- 25599 FEVERTEST - bag of 10 blister
- 25596 FEVERTEST BULK - box of 100 - hospital use
- 25600 FEVERCONTROL - bag of 10 blister



101

## 48h FEVERMONITOR

- 25601 48h FEVER MONITOR - bag of 10 blister of 3 pcs.

**25601**

Innovative "continual" fever indicator for 48h monitoring, for babies. Disposable, non toxic, mercury free, safe, unbreakable, reliable, easy to read, liquid crystal thermometers. It indicates temperature in 30 seconds. Medical Device.

**MADE IN ITALY**

Blister in GB, IT **CE 0051**

# DIGITAL THERMOMETERS

60 SECONDS



25564

- 25564 GIMA VALUE DIGITAL THERMOMETER °C - box - rigid tip

30-60 SECONDS CE 0197



25559-60-65

- 25559 GIMA DIGITAL THERMOMETER °C - box - 30 seconds Sold in a counter display of 36 pcs. (GB - IT)
- 25560 GIMA DIGITAL THERMOMETER °C - hang box - 60 seconds - GB, FR, IT, ES, PT, DE, GR, Arabic.
- 25565 GIMA DIGITAL THERMOMETER °C - hang box - 60 seconds - GB, IT, PL, SE, FI, CZ, RO, HR.
- 25561 GIMA DIGITAL THERMOMETER °F - hang box - 60 seconds (89,6-107,6 °F) - GB, FR, IT, ES, PT, DE, GR, Arabic.

60 SECONDS CE 0197



- 25557 FLEXI JUMBO 2 DIGITAL THERMOMETER °C - hang box, flexible tip, water-proof resistant, fever alarm

30 SECONDS CE 0476



- 25562 W-P DIGITAL THERMOMETER °C - hang box water-proof

30 SECONDS CE 0476



- 25563 FLEXI DIGITAL THERMOMETER °C - hang box flexible tip, water-proof

22 SECONDS



25552

- 25552 WIDE SCREEN DIGITAL THERMOMETER - box flexible tip, large display 27x22 mm. Battery 1.5 V button size

10 SECONDS BACKLIGHT



25553

- 25553 BL1 WIDE SCREEN DIGITAL THERMOMETER - box flexible tip, water-proof, backlight after measurement, wide display (27x22 mm). Battery 3 V button size. Low battery indicator.

# BABY THERMOMETER

30 SECONDS CE 0476 Multilingual box and manual: GB, FR, IT, ES.



- 25544 FROG DIGITAL THERMOMETER °C - hang box - flexible tip. Display range 32-42.9 °C (90.0-109.9°F)



25560



25558



Counter display of 36 pieces 25559

## GIMA DIGITAL THERMOMETERS

- Available in °C or °F, provide accurate and quick read-out. Safe and easy to use with clear and large display.
- display range: 32.0-42.9°C (25556-7, 25559-60, 25562-5, 25552-4) 32.0-42.0°C (25558)
  - accuracy ±0.1°C (±0.2°F)
  - memory: last reading
  - beeper function and auto shut-off
  - plastic case
  - multilingual manual and box (GB, FR, IT, ES, PT, GR) 25556, 25557, 25558 have also PL, Arabic. See beside for 25560/61/65
  - 25549 BATTERY 1.5 V LR/41 - box of 20 for all thermometers except 25558, 25553, 25554

10 SECONDS CE 0197 FDA



- 25558 FLEXI JUMBO DIGITAL THERMOMETER °C/°F (switchable) - hang box, flexible tip, water-proof, fever alarm, backlight jumbo display (27.5x12 mm). Battery CR1632. Rectal/oral use.

8 SECONDS CE 0197



- 25556 INSTANT DIGITAL THERMOMETER °C/°F (switchable) - hang box, flexible tip, water-proof, fever alarm, large display

20 SECONDS GREEN/ORANGE/RED BACKLIGHT



Lower than 37.1 °C will show green. Between 37.2 and 37.9 °C will show orange. Between 38.0 °C and 43.0 °C will show red mean fever

Battery 3 V button size (CR2032)



- 25554 BL3 WIDE SCREEN DIGITAL THERMOMETER - blister flexible tip, water-proof, red/orange/green backlight after measurement, wide display 29.3x15.3 mm. Low battery indicator

# BASAL THERMOMETER

- 25608 DIGITAL BASAL THERMOMETER °C - hang box - water-proof With 4 digits, 2 decimals, for fertility control. Multilingual box and manual: GB, FR, IT, ES, PT, DE, GR, Arabic. CE 0476

4 DIGITS, 2 DECIMALS

25608



## QUALITY PILL SPLITTERS AND PILL PULVERIZERS

These easy tools are ideal for elderly people, children and hospital attendants. Useful also for medicating pets. They avoid dispersion of medicine and guarantee integrity of the dose. Easy to clean, also in dishwasher. Made of non-toxic, unbreakable material.

- 25729 PILL SPLITTER - bulk
- 25730 PILL SPLITTER - with box
- 25743 ULTRA PILL SPLITTER - blister

Accurately divide tablets, large and small pills for reduced dosage or easier ingestion. Simple to operate. Top quality products, made in Europe (25729-30), USA (25743)

- 25747 DISPLAY FOR SPLITTER (25730) PULVERIZER (25731) - empty (English language)

Suitable for 4 pill splitters and 4 pill pulverizers. Available in any language on request.

- 25731 PILL PULVERIZER - with box
- 25738 CRUSH PILL PULVERIZER - blister

Powerful pulverizing point, powders pills of any shape and size, with an easy twist of the wrist.

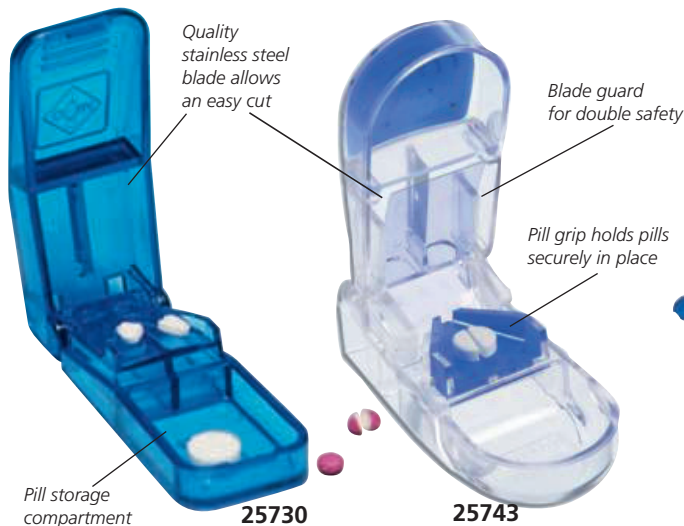

Multilingual box and instructions:  
GB, FR, IT, ES, DE, PT, PL, GR (25730, 25731)  
GB, IT, ES (25743)  
GB, FR, IT, ES (25738)

## MIXED COLOURS PILL SPLITTERS - BOX OR DISPLAY



- 25736 PILL SPLITTER - box of 12 pcs

This box includes 12 pill splitters in 4 colours: light blue, white, transparent lavender and transparent orange.

- 25737 PILL SPLITTER - display box of 12 pcs
- Counter display box including 12 pill splitters in 4 colours (light blue, white, transparent lavender and transparent orange) in a single cardboard box.



## COMBO SPLITTER-CRUSHER PILL BOX TIMER



- 25766 COMBO PILL MANAGER 4 IN 1
- Four functions in a practical device: pill splitter, pill crusher, pill box and water cup.

25766

## PILL BOX TIMER

- 25765 PILL BOX TIMER

Pocket pill box timer in ABS material, size 90x50x19 mm, supplied in cardboard box with batteries.

Double pill box space to store pills and tablets. It reminds when you have to take your medication with a countdown up to 19 hours and 59 minutes.



25765

## VIALS OPENER

- 25739 VIALS OPENER - box of 20

A practical tool to help opening vials in a safe way.

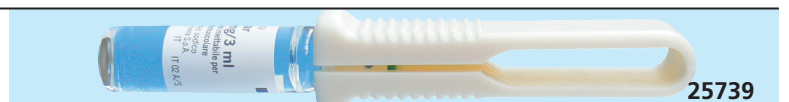

25739

# PILL BOXES: 7 DAYS AND SINGLE DAY PLANNERS

- 25751 7-DAY TOWER PLANNER - GB, FR
- 25753 7-DAY TOWER PLANNER - IT, DE
- 25755 7-DAY TOWER PLANNER - ES, PT

Available in any other language minimum 2,000 pcs (available in 90 days).



7 detachable 4-compartment boxes (morning, noon, evening, night) Size: 10.5x3.5x1.5 cm

25751



Size: 13x11x3.5 cm

- 25732 - 7 DAYS PILL BOX blue translucent

Translucent top enables the user to see if medication has been taken



It comes with one set of labels for individual marking of compartments in 11 languages (GB, FR, IT, ES, DE, PT, PL, GR, HU, RO, SE)

With 7 detachable 4 compartments small boxes (morning, noon, evening and night)

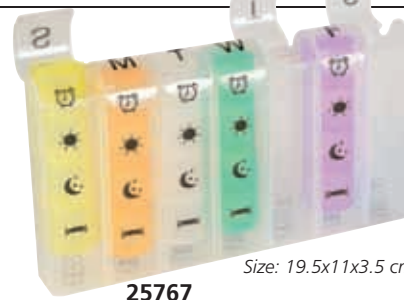

25767

Size: 19.5x11x3.5 cm

- 25767 7-DAY SPRING PLANNER x4 - GB
  - 25768 7-DAY SPRING PLANNER x4 - FR
  - 25769 7-DAY SPRING PLANNER x4 - IT
- Available in any language min 2,000 pcs (available in 90 days). All spring planners have braille in English.



7 detachable 4-compartment boxes Size: 9x2xh 2.5 cm



25761

Size: 18x11.5x2.5 cm

- 25761 7-DAY EASY PLANNER x4 - GB
  - 25762 7-DAY EASY PLANNER x4 - FR
  - 25763 7-DAY EASY PLANNER x4 - IT
  - 25764 7-DAY EASY PLANNER x4 - ES
- Available in any other language minimum 2,000 pcs (available in 90 days).

7 detachable 4-compartment boxes (morning, noon, evening, night) Size: 10x2.5xh 2 cm



41501

- 41500 7-DAY PILL PLANNER x2 - GB
  - 41501 7-DAY PILL PLANNER x2 - IT
- 2 translucent colours. Size 18.3x9.3x3.3 cm.

14 compartments

Pill planners available in other languages, minimum 2,000 pcs (availability 120 days)



2 pill compartments for each day of the week (morning and afternoon) with colour codes

41500



41505

- 41505 7-DAY PILL PLANNER x4 - GB
  - 41506 7-DAY PILL PLANNER x4 - IT
- 4 translucent colours. Size 19x13x2.8 cm.

Pill clearly visible through transparent lids



41506

Contoured design for easy pill removal

Holds up to 50 pills



25750

25752



25754

25735



25734



25830

25831

25832

25833

- 25750 DAILY PILL BOX pack of 2 pcs - blue/pink - pouch - GB
- 25735 DAILY PILL BOX - yellow - box - GB, FR, IT, ES, PT, DE, PL, SE, GR, Arabic
- 25752 DAILY PILL BOX - blue translucent - blister
- 25754 DAILY PILL BOX - white - pouch

- 25734 WEEKLY PILL BOX - white - box
- 25830 WEEKLY PILL BOX - transparent - hang box - GB
- 25831 WEEKLY PILL BOX - transparent - hang box - FR, ES, RO
- 25832 WEEKLY PILL BOX - transparent - hang box - IT
- 25833 WEEKLY PILL BOX - transparent - hang box - SE, DK, NO

	DAILY				WEEKLY							
	25750	25754	25752	25735	25734	25830, 25833	41500, 41501	25732	25751, 25755	25761, 25764	25767, 25769	41505, 41506
Compartments	2	4	6	6	7	7	14 (2x7)	28 (4x7)	28 (4x7)	28 (4x7)	28 (4x7)	28 (4x7)
Translucent	yes	no	yes	no	no	yes	yes	yes	yes	yes	yes	yes
Size (cm)	7x5x2	10x2x2	8x5.5x1.5	8x5.5x1.5	13x2.5x2	14.5x3x2	18.3x9.3x3.3	17x12x2	13x11x3.5	18x11.5x2.5	19.5x11x3.5	19x13x2.8
Package	pouch	pouch	blister	box	box	box	box	box	box	box	box	box

## □ PILL CRUSHING DEVICE

- **25872 SILENT KNIGHT HOSPITAL PILL CRUSHING DEVICE**
  - **25873 PILL CRUSHER POUCHES - 1,000 pouches (20 packs of 50)**
- Professional, silent crusher for hospital to effortlessly and easily reduce pills in fine powder in few-seconds. Pouches avoid any cross contamination and eliminate loss of medication. Silent Knight is supplied with 50 pouches.



- Step 1:** place pills into pill crusher pouch. Lift handle and place pouch down between the crusher plates to initiate crushing.
- Step 2:** press handle down to crush pills.
- Step 3:** press the handle down to activate grinding movement. Press handle down several times to grind pills into fine powder.
- Step 4:** remove the pouch.

## □ ELECTRIC PILL GRINDER

- **25850 SEVERO ELECTRIC PILL GRINDER**
- Professional silent pill grinder for fast and effective crushing of medication in hospitals, nursing homes and home care organizations. It avoids exposure to dust or cross contamination. The device works through autonomous grinding cycles via combined compression and rotation, through which it is possible to grind multiple standard pills and coated pills per cycle. Once the medicine is put into the 30 ml special cup, it takes only 8 seconds (for regular pills) to obtain it as powder. Pulverized pills are ideal for people who have trouble swallowing pills or to be administered via feeding tubes. Supplied with stainless steel grinding head, 30 cups, 30 cellophane grinding sheets, AC/DC adapter and GB, FR, IT, PT manual. Available DE, NL on [www.gimaitaly.com](http://www.gimaitaly.com).

**25850**

**MADE IN NETHERLANDS**

**FROM PILL TO POWDER IN FEW SECONDS**

**TECHNICAL SPECIFICATIONS**

Cup volume:	30 ml
Grinding cycle time:	8 seconds for regular pills
Sound level:	52dB
Battery:	rechargeable lithium-ion, 12 V 3 Ah
Battery last:	500 crushing's (three days of continuous working)
Charging time:	2 hours
Size - weight:	80x70x217 mm - 1.5 kg

**25851**

**25850 + 25854**

**25851 SEVERO MEDICINE CUPS - box of 2100**

**25852 SEVERO CUP LIDS - box of 2000**

**25853 SEVERO CELLOPHANE GRINDING SHEETS - box of 2100**

**25854 SEVERO MAGNETIC STABILITY PLATE**

Powder coated metal plate and magnetic sticker to be inserted underneath to stabilize Severo on medication trolleys.

## □ PILL DISPENSER - BLUETOOTH

- **25871 BLUETOOTH PILL DISPENSER**
- Automatic pill dispenser with Bluetooth to manage and record pills' dosage data with Healbox App and cloud server. It lets patients and caregivers to program dosages up to a maximum of 28 consecutive days. It also allows to give right dose to right patients at right time. The device has audio and visual alerts up to 9 alarms per day, which sound for 30 minutes or until the dispenser is flipped. It automatically rotates when it's time for the next dose. 28 compartments with 24 aspirin sized pills load capacity. Lid can be locked with metal key.
- For hospital, community service or personal use. Supplied with 1 medication tray, 1 set of dosage rings, 1 metal key, 4xAA batteries and multilingual instructions (GB, FR, IT, ES, PT)

**TECHNICAL SPECIFICATIONS**

Compartments:	28 slots	Bluetooth:	10 meters limited range
Capacity:	24 Aspirin-sized pills	Battery:	4xAA batteries
Material:	ABS	Size:	225x h 68 mm
LED display size:	60x30 mm	Weight:	600 g



## □ GRASPING TOOLS

- **28960 GRASPING TOOL - 3 WAYS - 66 cm**
- Aluminium body, PP handle. Three grasping ways: steel hook, magnetic tip, rubber head.

- **28963 GRASPING TOOL - foldable**
- Extended reach grasping tool helps to eliminate bending or climbing for hard-to-reach items. Length: 80 cm, foldable in 2. Locking tab holds the item in place.

# EASY LIFE: AIDS FOR DAILY LIVING



• **28920 CUTLERY SET**  
 • **28921 BENDABLE CUTLERY SET**  
 Set of 4 pieces (knife, fork, tea and table spoon). Made of stainless steel with thick, ribbed rubber handle (11 cm) for easy grip



• **28925 SPOON & FORK HOLDERS - pack of 2 pcs.**  
 These portable, stylish holders fit onto virtually any style spoon and fork providing a secure grip (spoon and fork are not included).



• **28966 DRINKING GLASS - box of 210**  
 Drinking glass made of polypropylene with a separated tap and a lip. Capacity 250 ml graduated by 25 ml. Autoclavable. Dishwasher safe. Not for microwaves.



Capacity: 295 ml Diameter: 7.60 cm (3")  
 Height: 12.7 cm (5") Weight: 0.27 kg

• **28967 HANDLE GRIP CUP**  
 Transparent plastic resistant mug with two large handles to allow a more secure grip. Extra-wide base for stability and to reduce tipping over. It includes a spouted lid with a little hole for straws. Suitable for patients with limited hand control and tremors. Mug only is dishwasher and microwave safe.

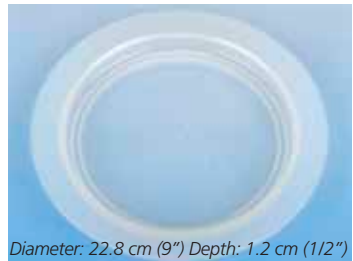

Diameter: 22.8 cm (9") Depth: 1.2 cm (1/2")

• **28930 INNER LIP PLATE**  
 High rim around the entire plate to keep food from sliding off and prevent food spills. Raised lip facilitates the grasping of food with fork or spoon. Made of durable transparent plastic, which is dishwasher and microwave safe.

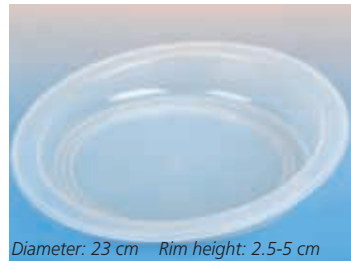

Diameter: 23 cm Rim height: 2.5-5 cm

• **28931 HIGH RIM PLATE**  
 Polypropylene high rim plate with one side higher than the other to allow one-handed eating. Higher side facilitates the grasping of food with one hand without spilling it. Heat-resistant: 100-120°C Cooling resistant temperature: -20°C



Diameter: 22.8 cm (9")

• **28932 3-SECTION PLATE**  
 Plastic plate divided in 3 sections to keep food separate. It helps patients with physical disabilities, tremors, Parkinson...to eat independently. Made of resistant plastic.



Diameter: 22.8 cm (9")

• **28935 SUCTION PAD for plates**  
 White anti-slip suction pad with patented vacuum system to be attached on flat surface with slight pressure. It holds plate in place allowing patients with disease, which restrict hand movement, to eat and drink independently and reduce accidental spills.

Multilingual box and instructions: GB, FR, IT, ES, PT, DE, GR, Arabic.



• **28915 LONG BATH SPONGE**  
 Lightweight sponge features soft polyfoam attached to a plastic handle. Available with contoured sponge.



28951

• **28951 JAR OPENER & CLOSER**  
 This uniquely designed product concentrates hand power to remove lids and turn facets effortlessly.



• **28950 EASY OPENER**  
 All in one product easily opens bottle caps, pull tabs and even impossible box tops! Designed to provide safety for the user.



• **28906 MAGNIFYING GLASS**  
 Magnifies two times larger than original size. Large enough to do what's needed. Small, portable, fitting easily into purse or pocket.



Can hold 1 to 3 keys. Keys fold into handle when not in use to slip into pocket or purse.

Length 13 cm

• **28941 MULTIPLE KEY TURNER**  
 Designed to assist people with limited wrist strength or movement (arthritis or other limited hand mobility) to manipulate keys with ease. House keys and most car keys (without plastic head covers) fit into the slots and are held by a single screw.



With cover

• **28912 SOCK AID NOTCH**  
 Soft terry cloth side grips the sock, while smooth nylon side reduces friction, allowing foot to slip in easily. Two long loop handles are easy to hold and assist with pulling the sock onto foot. Ideal for people who can use one hand only or with decreased strength or coordination.



28911

• **28911 ZIPPER AND BUTTON PULLER**  
 It helps pulling the button or zipper into position. Folds to half-length to fit easily into pocket or purse. Ideal for people with weak or arthritic fingers.



• **28945 SHOPPING BAG CARRIER**  
 This product provides an effort-free handle that remains constantly supportive, regardless of bag loads.

PHARMADOCT FIRST AID, MEDICATION AND WELLNESS



All products are in blister with 7 languages package (GB, FR, IT, ES, DE, PT, GR) except 25332, 25370, 25380/82/90 (only GB, FR, IT, ES, DE)

GIMA code	PHARMADOCT LINE	Pieces per box	Minimum order*	GIMA code	PHARMADOCT LINE	Pieces per box	Minimum order*
25300	Classic plasters - 7x2 cm	20	12 box	25316	Herpes patch	15	12 box
25301	Classic plasters - 5 assorted sizes**	30	12 box	25318	Nasal strips	10	12 box
25302	Classic plasters - 6 assorted sizes***	100	12 box	25372	Ear plugs	4	12 box
25305	Hypoallergenic plasters - 5 assorted sizes**	30	12 box	25350	Corn plasters	10	12 box
25307	Hypoallergenic plasters - 2 (7.5x7.5), 2 (7.5x10)	4	12 box	25351	Oval corn plasters	9	12 box
25310	Children plasters "tattoo" 10 (6x2), 6 (7x3.8)	16	12 box	25352	Blister plasters	5	12 box
25312	Plasters with hemostatic gauze	20	12 box	25370	Dental floss	1	12 box
25314	Hand plasters - 5 (12x2), 5 (7x2), 4 (butterfly)	14	12 box	25380	Lip balm classic	1	12 box
25320	Dressing strip 100x6 cm	1	12 box	25382	Lip balm strawberry	1	12 box
25322	Cloth roll - fabric - 5 mx1.25 cm	1	18 box	25360	Nail scissors	1	12 box
25324	Cloth roll 5 mx2.5 cm	1	12 box	25361	Cuticle clipper	1	12 box
25335	First aid - kit of 8 different products	8	8 box	25362	Nail file	1	12 box
25330	Cotton gauze swabs 18x40 cm	6	12 box	25363	Tweezer	1	12 box
25332	Elastic bandages 4 mx6 cm	2	6 box	25364	Small nail cutter	1	12 box
25337	Adhesive elastic compression bandage 2.5 m x 6 cm	1	6 box	25390	Condoms	12	8 box

\*Minimum order is carton of "X" boxes, each one containing "Y" pieces \*\*10 (7x2), 10 (4x1), 2 (3.8x3.8), 4 (7x2.4), 4 (Ø 2.5)

\*\*\*30 (7x2), 20 (4x1), 20 (7x2.4), 10 (Ø 2.5), 14 (6x2), 6 (3.8x3.8)

Graphic of Pharmadoc line boxes are subject to changes



## C-FOLD AND V-FOLD HAND TOWELS



• **25200 C-FOLD HAND TOWELS** - pack of 150 pcs.  
Pure cellulose, 1 ply. Size 23x33 (folded 23x11 cm).  
minimum order: box of 24 packs

• **25205 DISPENSER**  
For C and V fold hand towels



• **25202 V-FOLD HAND TOWELS** - 2 plies - pack of 160 pcs.  
minimum order: 3,200 (20 packs of 160)  
Pure wadding of cellulose, 2 plies (36 g/m<sup>2</sup>: 2x18 g/m<sup>2</sup>).  
Size: 25x22.6 cm (folded 25x11.3 cm)

## ABSORBENT NON WOVEN WIPES



Non woven absorbent wipes for sanitary, health and hygienic use. Made of wood pulp, PES, spunbonded PP.

GIMA code	Model	Size cm	Weight g	Minimum order
25221	Smooth	30x40	45-50	1.400 pcs**
25222	Smooth - folded	30x40	45-50	1.400 pcs***
25223	Microembossed - folded	20x40	45-50	1.400 pcs***

\*Size accuracy: ±5% \*\*14 boxes of 100 \*\*\*28 boxes of 50

## HAND TOWELS ROLLS



• **25210 HAND TOWEL ROLLS** - box of 12  
Pure cellulose, 2 plies (36 g/m<sup>2</sup>).  
Size 23x24 cm.  
N. of sheets: 252.  
• **25215 DISPENSER**  
For hand towel rolls



## FOLDED NAPKINS

### FOLDED NAPKINS

Pre-coated folded napkins, made of 2 plies of pure cellulose wadding laminated with 1 ply of polyethylene or 1 ply of pure cellulose wadding laminated with 1 ply of polyethylene.  
High absorbency and waterproofness to assure high comfort.

GIMA code	FOLDED NAPKINS - pack of 500 pcs		
Napkins 2+1 (2 plies cellulose + 1 ply polyethylene)			
25230	Napkins 33x45 cm	- green	
25231	Napkins 33x45 cm	- light blue	
25232	Napkins 33x45 cm	- pink	
25233	Napkins 33x45 cm	- white	
Napkins 1+1 (1 ply cellulose + 1 ply polyethylene)			
25226	Napkins 33x45 cm	- blue	
25227	Napkins 33x45 cm	- lilac	
25228	Napkins 33x45 cm	- orange	
25240	Plastic dispenser		
25239	Chain for napkins		



## INVALID RINGS



Quality invalid rings made of rubber.  
Internal hole Ø 14 cm.



GIMA code	INVALID RUBBER RINGS
28610	Invalid ring Ø 35 cm
28611	Invalid ring Ø 40 cm
28612	Invalid ring Ø 45 cm
28614	Pump for invalid ring

## BIBS

• **25672 BIBS 50x60 cm** - box of 6 rolls of 80 bibs

Made of 2 plies, one of highly absorbent cellulose tissue and one of waterproof polyethylene.  
Extremely soft and comfortable, they assure an excellent protection to the patient.  
Each roll has 80 bibs with pre-cut and comfortable ribbons or bi-adhesive.

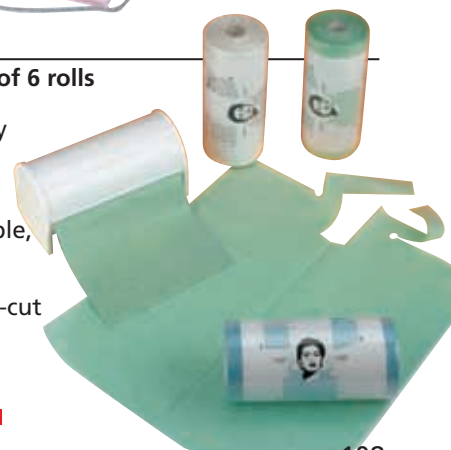

## TRAVELJOHN™ RESEALABLE DISPOSABLE URINAL AND VOMIT BAG



**TRAVELJOHN™ DISPOSABLE URINAL AND VOMIT BAG**  
 Disposable personal urinal or vomit (only 25887) bag for men, women and children.  
 Each bag contains a pouch filled with LIQSORB®, a unique polymer substance that absorbs liquid waste and turns it instantly into odourless spill-proof gel.  
 The peel and seal closure (25879, 25887) or air-tight closure (25880) ensure complete odour control. Reusable until it is full, can be simply thrown as normal waste.  
 2 in 1 design for vomit or urination use (only 25887).

GIMA code	TRAVELJOHN™ DISPOSABLE BAGS	Unisex adapter	Minimum order
25879	Paper urinal bag 800 cc	flexible	box of 4
25880	Plastic urinal bag 800 cc	rigid	box of 3
25887	Paper urinal and vomit bag 800 cc	-	box of 5

## SOFFISOF INCONTINENCE PADS

**SOFFISOF CLASSIC AND AIR DRY INCONTINENCE PADS**  
 Anatomically shaped absorbent diapers with repositionable fastening tapes. Made of fluff of pure cellulose (100% PEFC certified), superabsorbent polymers and waterproof exterior layer. They ensure maximum safety in case of moderate or

high incontinence level. Hypoallergenic, dermo protective with odour control. The new design guarantees maximum comfort. Gradual fade wetness indicator easily suggests when it's time for a change. Air Dry pads have a special breathable outer layer that helps to reduce the onset of redness and irritations.



Medium	Large	XX-Large	SOFFISOF CLASSIC	Minimum order
Circumference (cm)				
70-110	100-150	155-175		
36701	36702	-	Moderate incontinence-day	box of 90*
36704	36705	36706	Heavy incontinence-night	box of 60**

\*6 boxes of 15 \*\*4 boxes of 15



Medium	Large	XX-Large	SOFFISOF AIR DRY	Minimum order
Circumference (cm)				
70-110	100-150	155-175		
36707	36708	-	Moderate incontinence-day	box of 90*
36710	36711	36712	Heavy incontinence-night	box of 60**

\*6 boxes of 15 \*\*4 boxes of 15

## SOFFISOF INCONTINENCE AIR DRY PANTS PULL-UP

**SOFFISOF AIR DRY PANTS/PULL-UP**  
 Disposable absorbent panty ideal for walking, self-sufficient and active patients, with slight to severe leakages. Air dry, hypoallergenic, dermo protective with odour control. Outer lining in soft breathable fabric allows skin to breathe. Ergonomic elastic band for maximum comfort and greater fit. Soft elastic and thigh line barriers ensure maximum leak protection. Gradual fade wetness indicator easily suggests panty change.



Medium	Large	X-Large	SOFFISOF PANTS/PULL-UP	Minimum order
Circumference (cm)				
70-110	110-150	135-160		
36715	36716	-	Moderate incontinence-day	box of 84*
-	-	36717	Moderate incontinence-day	box of 48**
36718	36719	-	Heavy incontinence-night	box of 32***

\*6 boxes of 14 \*\*4 boxes of 12 \*\*\*4 boxes of 8

## SOFFISOF ABSORBENT BED PADS

**SOFFISOF ABSORBENT BED PADS**  
 Absorbent bed pads ideal for protecting beds, mattresses, armchairs and chairs. The layer in contact with the skin is made of soft non-woven fabric, inner mattress in superabsorbent fluff of pure cellulose and the outer side is in polyethylene, an excellent barrier against liquids. Larger size (36721, 36723) has foldable side flaps tuckable under the mattress to ensure maximum protection.

100% PEFC certified cellulose

GIMA code	SOFFISOF ABSORBENT BED PADS	Size	Minimum order
<b>CLASSIC LINE</b>			
36720	Heavy incontinence	60x90 cm	box of 90*
36721	Heavy incontinence	80x180 cm	box of 90*
<b>IDEALITE LINE</b>			
36722	Moderate incontinence	60x90 cm	box of 180**
36723	Moderate incontinence	80x180 cm	box of 180**

\*6 boxes of 15 \*\*6 boxes of 30



## BIBS WITH POCKET

Size: 37x67 cm  
+ 10 cm (pocket)

Extremely soft and comfortable

Large pocket



36666

Easy fastening on patient by laces

- **36666 BIBS WITH POCKET - box of 600**  
Disposable bibs made of 1 ply of highly absorbent wadding of cellulose and 1 ply of waterproof blue polyethylene. Box of 600 (6 bags of 100).

## PATIENT ANTI-HANDLING SUIT

### PATIENT ANTI-HANDLING SUIT

The suit prevents the patient from handling himself during night or day. The zip allows the operator to intervene easily on the patient, for hygiene. Back closure with double slider zip and final reinforcement. Long sleeves with soft elastic at the cuffs and bottom of the leg; double reinforced crotch. Made of 100% polyester honeycomb stretch weft. Resistant to washing with chlorine at 38°C and in water with detergent at 90°C. Weight: gr/m<sup>2</sup> 200 ±5%. Quick drying and thermoregulating.

>100\* WASHES

\*Resistant to washing with chlorine at 38°C and in water with detergent at 90°C

MADE IN ITALY

PATIENT ANTI-HANDLING SUIT	
GIMA code	Unisex - green
36730	Anti-handling suit - S
36731	Anti-handling suit - M
36732	Anti-handling suit - L
36733	Anti-handling suit - XL



Front



Back

## SOAPED SPONGE, SOAPED AND NON SOAPED WASH GLOVE



36659

- **36659 SOAPED SPONGE - box of 100**  
Disposable sponge in foam soaked with anallergenic, neutral PH soap. Ideal for patient cleaning and hygiene. Individually packed. Size: 7.5x12xh 2.5 cm.



36663

- **36663 SOAPED WASH GLOVE - box of 50**  
Disposable mitten to wash patient. Made of non woven and sponge, soaked with liquid soap with neutral PH and anallergenic. Ideal for patient cleaning and hygiene. Size: 15x25 cm.



36661

- **36661 WASH GLOVE - box of 1,000 (20 bags of 50)**  
Disposable wash glove to clean patients. Made of soft curacell, which allows to gently soap and rinse patient, and waterproof PE. Embossed surface allows a deep cleaning. Size: 16.5x22 cm.

MADE IN ITALY

## SKIN SOAP

- **36671 FRAGRANCE SKIN SOAP - 1,000 ml**  
Delicate, skin protective, fragrance soothing bath and shower with moisturizer active agents. It respects the lipid mantle and it is delicate on skin, leaving it fresh and pleasantly soft. It is used for daily personal hygiene as a normal liquid soap, bath, shower and shampoo. Suitable for frequent washing, it protects and soothes sensitive skin of children and elderly people. Fast to be rinsed, it leaves a fresh cleanness sensation.



36671

MADE IN ITALY

- **36692 DISPENSER PUMP - optional**

## GERMELLA

- **36672 GERMELLA - 1,000 ml**  
Germella is a skin-protecting liquid detergent combining the properties of three extraordinary medical plants: **Camomile, Sage and Aloe**. Camomile and Sage have moisturizing and soothing qualities. Aloe Vera has soothing property and makes your skin soft and velvety. Germella is a delicate detergent, which respects the natural defence of skin and mucous membranes. Its natural ingredients make it also suitable for daily intimate care.



36672

MADE IN ITALY

- **36692 DISPENSER PUMP - optional**

## SEPTI SAVON

- **36674 SEPTI SAVON - 250 ml - box of 12**  
Septi Savon is a 5.5 pH soap with antibacterial agents that prevents and eliminates unpleasant odours. The presence of orthophenylphenol and Benzalkonium chloride guarantees a sanitizing and antibacterial action. Delicate on the skin, it can be used for total body shower and for children.



36674

Pump included

- Its neutral formula, enriched by glycerine, helps to maintain normal equilibrium of skin and prevents dehydration even after repeated washing.

MADE IN ITALY

## DOSASOAP NO-TOUCH HAND-WASH SYSTEM

- **36677 DOSASOAP NO-TOUCH HAND WASH SYSTEM - white**  
Dosasoap is a no-touch dispenser for antiseptics, convenient for detergents, liquid soaps and gels. Equipped with sensor that detects hand movements, it dispenses the product in a comfortable way. Dosasoap ensures a rapid and safe hand hygiene, without any contact with the dispenser and unnecessary waste. Suitable for use with 1 litre bottles (36671, 36672).

36677



36678

- **36678 PUMP FOR DOSASOAP - spare**



1 litre bottle

Dosasoap

# GRADUAL COMPRESSION, UNISEX, COTTON SOCKS

## UNISEX GRADUAL COMPRESSION COTTON SOCKS

High quality knee socks made of soft cotton combined with elastic fibres to provide proper gradual compression. Special attention was applied to the development of this cotton product line to ensure maximum fibre quality, along with a soft elastic cuff that offers excellent levels of expandibility: all to ensure maximum comfort and wellness throughout the day.

This product line is available in two compression levels (medium and strong) and in two colours (black and blue). On request, for quantities of 100 or more they are also available in light and extra strong compression and beige and grey colours.

**Medium compression level: 14-16 mm/Hg at the ankle**  
To help prevent discomfort and heaviness in the legs.  
Composition: 67% cotton, 26% polyamide, 7% elastane.

**High compression level: 15-21 mm/Hg at the ankle**  
To help prevent the onset of venous disease.  
Composition: 63% cotton, 27% polyamide, 10% elastane.  
It is a Medical Device.



Multilingual box and instructions:  
GB, FR, IT, ES, PT, DE, GR, HU



GRADUAL COMPRESSION COTTON SOCKS - pair					
MEDIUM COMPRESSION SOCKS					
Colour	Small	Medium	Large	X-Large	XX-Large
Black	41220	41221	41222	41223	41224
Dark blue	41225	41226	41227	41228	41229
STRONG COMPRESSION SOCKS					
Colour	Small	Medium	Large	X-Large	XX-Large
Black	41240	41241	41242	41243	41244
Dark blue	41245	41246	41247	41248	41249
Shoe size					
European	37 - 39	39 - 41	41 - 43	43 - 45	45 - 47
US - Men	5 - 6½	6½ - 8	8 - 9½	9½ - 11	11 - 12½
US - Women	6½ - 8	8 - 10	10 & over	-	-



# SUPPORT SHEER LINE

Knee Socks, Stockings and Tights designed for dynamic women who need the preventive action of elastic compression but don't want to compromise on style.

This elegant product line features a true heel, an anti-shrink cuff and super soft fabrics. Available in two compression levels (medium and strong) and in beige or black.

**Medium compression level: 70 den - 10-14 mm/Hg at the ankle**  
Ideal for those who would like to initiate a prevention programme, but are mainly interested in the comfort and well-being offered by elastic compression stockings.  
Composition: 84% polyamide, 16% elastane (Stay ups, Pantyhoses).  
85% polyamide, 15% elastane (Knee-highs).

**Strong compression level: 140 den - 15-21 mm/Hg at the ankle**  
Ideal for those suffering from the initial signs of ankle swelling and discomfort.

This level of compression is recommended for initial onset of varicose veins. The product's compression level supports and massages the leg, providing effective relief throughout the day. While this product line boasts an elegant design, particular attention has also been paid to maximum elasticity, which is ensured through the use of a honeycomb fabric (net fabric).

Doctor consult is recommended before use.  
Composition: 79% polyamide, 21% elastane.  
These products are Medical Devices.



Multilingual box and instructions:  
GB, FR, IT, ES, PT, DE, GR, HU



Knee-high with a gradual compression, comfort top, honeycomb mesh



Multilingual box and instructions: GB, FR, IT, ES, PT, DE, GR, HU



Stay ups with gradual compression, silicone lace top, honeycomb mesh



Multilingual box and instructions: GB, FR, IT, ES, PT, DE, GR, HU



Pantyhose with gradual compression, reinforced body, honeycomb mesh

KNEE-HIGHS - pair		
MEDIUM COMPRESSION		
Colour	Small/Medium	Large/X-Large
Black	41100	41101
Beige	41102	41103
STRONG COMPRESSION		
Colour	Small/Medium	Large/X-Large
Black	41106	41107
Beige	41108	41109

STAY UPS - pair				
MEDIUM COMPRESSION				
Colour	Small	Medium	Large	X-Large
Black	41120	41121	41122	41123
Beige	41124	41125	41126	41127
STRONG COMPRESSION				
Colour	Small	Medium	Large	X-Large
Black	41132	41133	41134	41135
Beige	41136	41137	41138	41139

PANTYHOSES					
MEDIUM COMPRESSION					
Colour	Small	Medium	Large	X-Large	XX-Large
Black	41150	41151	41152	41153	41154
Beige	41155	41156	41157	41158	41159
STRONG COMPRESSION					
Colour	Small	Medium	Large	X-Large	XX-Large
Black	41165	41166	41167	41168	41169
Beige	41170	41171	41172	41173	41174

# ANTI-EMBOLISM ELASTIC STOCKINGS

Stockings for prophylaxis of thromboembolism before, during and after surgery.

Thanks to their descending graduated compression, these stockings are an excellent means of preventing increased blood viscosity, which can lead to the formation of thrombus. In order to guarantee a good fit and properly graduated compression, a great deal of attention has been applied to ensuring the high elasticity of the fabrics.

**Recommendations:**

- a valid aid in preventing thromboembolisms linked to surgical interventions
- treatments associated with post-traumatic therapies
- bruises, sprains and hydrostatic edemas

**Counter-indications:**

- localized dermatitis, erythema, necrosis
- stripping, pulmonary edema, grafts
- vascular disorders of cardiac origin
- legs of larger circumference

**Features:**

- decreasing compression from the ankle to the thigh
- true anatomic heel
- super soft elastic fabric, hypoallergenic (latex free)
- inspection opening on top of the foot

Composition: 82% polyamide, 18% elastane. These products are Medical Devices.

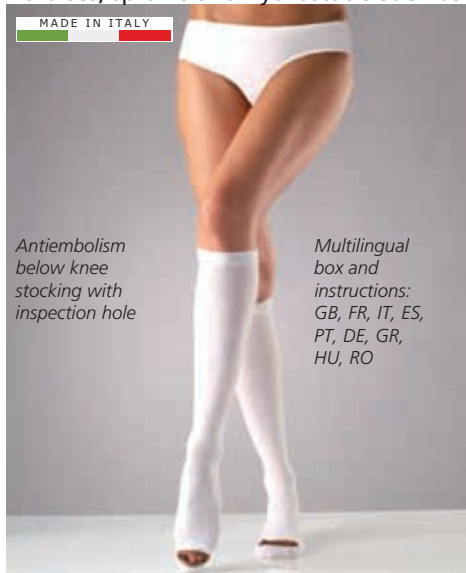

**BELOW KNEE - pair**

COMPRESSION mm/Hg 18-20 (at the ankle)				
Length	Small	Medium	Large	X-Large
38-43 cm	41310	41311	41312	41313



**THIGH LENGTH - pair**

COMPRESSION mm/Hg 18-20 (at the ankle)				
Length	Small	Medium	Large	X-Large
60-70 cm	41316	41317	41318	41319
70-80 cm	41320	41321	41322	41323
80-90 cm	41324	41325	41326	41327



**FULL LENGTH**

COMPRESSION mm/Hg 18-20 (at the ankle)				
Length	Small	Medium	Large	X-Large
70-80 cm	41330	41331	41332	41333

# FUNNY COMPRESSION SOCKS - NYLON-POLYESTER



41200 (S-M size)

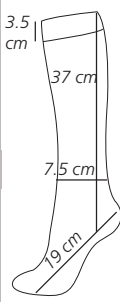

41200-1



41201 (S-M size)



41205 (L-XL size)

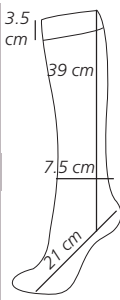

41205-6



41206 (L-XL size)

**FUNNY COMPRESSION SOCKS**  
 Colourful knee-high socks with graduated compression to improve blood circulation. Unique pattern and ergonomic design. Made of nylon and polyester which make socks breathable and moisture absorbent. Each pack includes 5 mixed pairs of socks. Compression level: 15-20 mm/Hg.

GIMA code	FUNNY COMPRESSION SOCKS	Size	Minimum order
41200	Funny pattern 1	S-M	box of 5
41201	Funny pattern 2	S-M	box of 5
41205	Funny pattern 5	L-XL	box of 5
41206	Funny pattern 6	L-XL	box of 5

**BENEFIT:** IMPROVE BLOOD CIRCULATION  
INCREASE ENERGY

ALL DAY SUPPORT  
LEG PAIN AND FATIGUE

## BATH/SHOWER STOOLS



42900

• **42900 SHOWER STOOL - fixed**  
Shower stool with aluminium frame and plastic seat 50x30 cm. Height adjustable 35-45 cm. Non slip end. Load: 100 kg



42901

• **42901 SHOWER STOOL - foldable**  
Shower stool with aluminium frame and plastic seat 50x30 cm. Height adjustable 44-47.5 cm. Non slip end. Load: 100 kg



42903

• **42903 SHOWER STOOL**  
Shower stool with aluminium frame and plastic seat Ø 32.5 cm. Height adjustable 38-56 cm. Non slip end. Load: 100 kg.

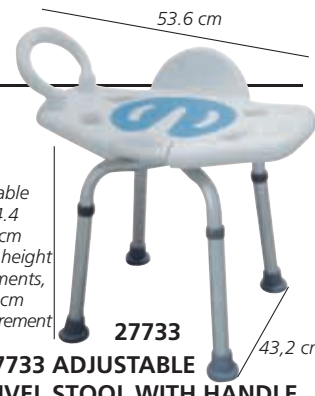

Adjustable seat 54.4 - 71.6 cm with 8 height adjustments, by 2.5 cm (1") increment

27733

• **27733 ADJUSTABLE SWIVEL STOOL WITH HANDLE**  
- swivel seat with 90 degree position lock at every right angle location  
- non-slip central seat pad and soft under-covers  
- load 135 kg (300 lbs)

• **42905 SHOWER STOOL WITH ARMRESTS**

Shower stool made of silver aluminium frame with PU seat, foam armrest and adjustable foot tube. Weight: 4.0 kg Load: 136 kg Size: 44.8-47.2x50-52.6x h 62.2-72 cm Multilingual manual: GB, FR, IT, ES, PT, DE, SE, GR.



42905

## BATH STEPS

• **42920 BATH STEP - 1 step**  
• **42921 BATH STEP - 2 steps**  
Stainless steel frame and plastic steps. Load: 100 kg

42920



Size: 27x41xh 14 cm



42921

Size: 51x41xh14-29 cm

## SAFETY SUCTION GRAB BARS



28974

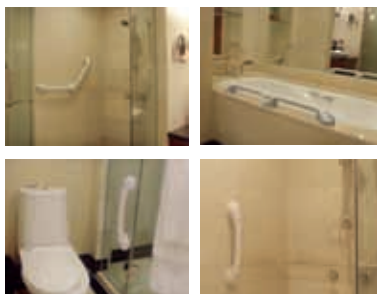

28972



28973

**VISIBLE SAFETY**  
GREEN means well attached  
RED is a warning signal. Need re-mount

• **28972 SAFETY GRAB BAR - 443 mm**  
• **28973 SAFETY GRAB BAR - 545 mm**  
• **28974 SAFETY DOUBLE GRAB BAR - 929 mm**  
Innovative line of GRAB BAR, can be quickly installed everywhere without need of drilling and screwing. Patented suction cups (Ø 93 mm). Holds up to 60 kg (28972/3) or 85 kg (28974) vertical and 45 or 60 kg (28974) lateral weight (tested by SGS). Ideal solution to support elder people during daily bathroom use. Top quality product made of heavy duty ABS, with patented "green/red" suction indicator for better safety. Multilingual box and manual: GB, FR, IT, ES, PT, DE, GR, Arabic

## PLASTIC RIBBED GRAB BAR



28977

28976

• **28975 PLASTIC RIBBED GRAB BAR - 30 cm**  
• **28976 PLASTIC RIBBED GRAB BAR - 45 cm**  
• **28977 PLASTIC RIBBED GRAB BAR - 60 cm**  
Ribbed plastic grab bar in Medical PVC, complete with ABS mounting plates and screw covers. Wall screws not included. Electrically isolated. The ribbed bars offer excellent anti-slip grid and are warm to the touch. Can be mounted either horizontally or vertically. Tube Ø 3.5 cm. Max user weight 120 kg (205 lb). Manual: GB, IT.

## U-SHAPE STEEL GRAB BAR

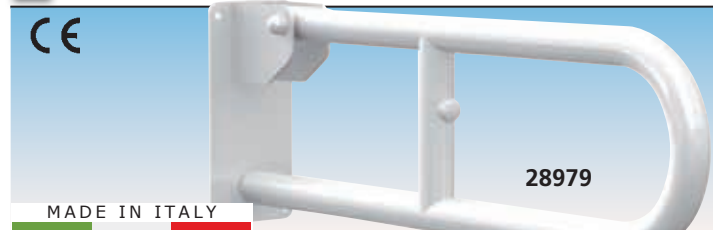

28979

• **28979 U-SHAPE STAINLESS STEEL GRAB BAR - 70 cm**  
White powder coated wall mounted lift up toilet support. Designed to help getting up or transferring to and from the toilet. It can be folded upwards for easy accessibility. Max user weight 125 kg (275 lb). Wall screws not included. Manual: GB, IT.

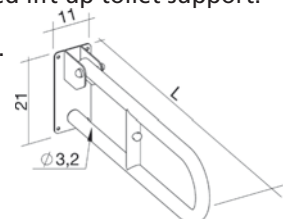

## BATH/SHOWER CHAIRS



27730

• **27730 SHOWER CHAIR with backrest**  
Aluminium frame, seat and backrest in plastic material. Height adjustable (35-45 cm), non slip end. Load: 100 kg.



42906

• **42906 REINFORCED SHOWER CHAIR with backrest**  
Aluminium frame, seat and backrest in plastic material. Height adjustable (42-52 cm), non slip end. Load: 150 kg.



42907

• **42907 SHOWER CHAIR with backrest and armrest**  
Aluminium frame, seat and backrest in plastic material. Height adjustable (41-54 cm). Load: 100 kg.



42909

Multilingual manual:  
GB, FR, IT, ES, PT, DE, SE, GR.

• **42909 SHOWER CHAIR with PU backrest and seat**  
Aluminium silver frame with PU backrest and seat. Height adjustable foot tube. Load: 136 kg. Weight: 4 kg.

## SHOWER COMMUNE CHAIR

• **42913 AQ-TICA SHOWER AND TOILET CHAIR - dark grey/white**  
Two function chair: body care and personal hygiene. It can be used as a toilet chair or as a shower chair. Delivered as a kit in a retail box can easily be mounted without any tools. Rust free structure made of aluminium and polypropylene. Supplied with hygienic pan with lid.

MADE IN FRANCE

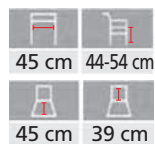

42913

Weight: 7.1 kg  
Max load: 130 kg

Removable armrest and backrest

Adjustable height aluminium legs (5 positions)

Pan removes from front

Drainage holes in the seat

## ROTATING SHOWER CHAIR

• **42912 ROTATING SHOWER CHAIR**  
Height adjustable and 360° rotating seat chair. Swing-up armrests make patient transfer easier. The lever locks the seat in 4 different positions. Aluminium silver frame with comfortable PU padded seat and backrest. Foam arm pad. It can be folded.  
Seat dimension: 40.7x33.7x h 5 cm  
Max load: 136 kg. Weight: 5.3 kg.  
Packing size: 52.5x36x h 42.5 cm  
Folding dimension: 51x34.5xh 40 cm.  
Multilingual manual: GB, FR, IT, ES, PT, DE, SE, GR.



Locking lever to lock seat into selected position



42912

## SHOWER COMMUNE WHEELCHAIR

• **42915 SHOWER COMMUNE WHEELCHAIR**  
Foldable shower commode wheelchair with white painted aluminium frame and plastic seat. Flip-up armrest and lockable front castors. Size: 75x44x48 cm  
Packing size: 67x29x53 cm  
Weight: 6 kg.  
Load: 100 kg.



42915



## BATH CHAIR

• **27755 SWIVEL BATH CHAIR**  
Revolving bath chair at 360° with 4 positions for easier access to bath. Polypropylene seat. Frame in painted steel, rotation system in stainless steel. Load: 100 kg. Weight: 5.5 kg.

MADE IN ITALY

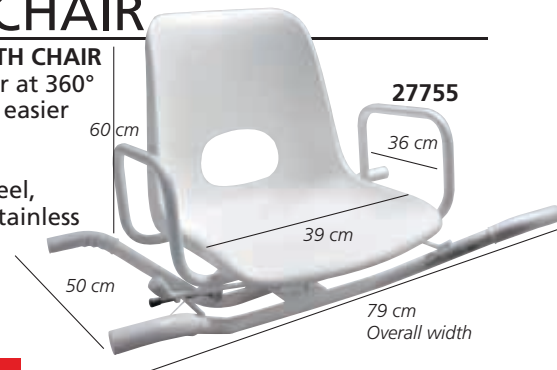

27755

## BATH SEAT

• **42910 BATH SEAT - adjustable**  
Aluminium frame and plastic seat (41x23 cm)  
Load: 100 kg.

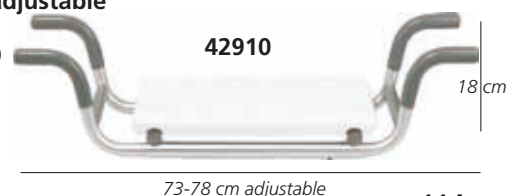

73-78 cm adjustable

## RAISED TOILET SEATS



**27750** Fixed armrest

• **27750 RAISED TOILET SEAT** height 12.5 cm with fixing system (front screw) and fixed armrest made of anodized aluminium. Max load 130 kg (286.6 lb). Packing: 410x165x468 mm



**27751** Reclining armrest

• **27751 RAISED TOILET SEAT** height 12.5 cm with fixing system (back and front screw) and anodized aluminium reclining armrest. Max load 130 kg (286.6 lb). Packing: 410x165x468 mm



**27756**

• **27756 CLIPPER RAISED TOILET SEAT** - 11 cm Easily adapts to any toilet bowl. Totally made of injected plastic. 4 fixation clips to secure strongly the seat on the toilet bowl. Max load 185 kg (407 lb).



**27741**

• **27741 RAISED TOILET SEAT** - 10 cm with lateral fixing system. Max load 250 kg (551 lb). Packing: 373x128x410 mm

Instructions: GB, IT, FR, ES, DE, PT, GR, SE, DK, PL, NL



**27740**

• **27740 RAISED TOILET SEAT** - 15 cm with lateral fixing system. Max load 250 kg (551 lb). Packing: 373x165x410 mm

Instructions: GB, IT, FR, ES, DE, PT, GR, SE, DK, PL, NL



**27735**

• **27735 RAISED TOILET SEAT** with LID - 10 cm  
• **27737 RAISED TOILET SEAT** with LID - 15 cm with lateral fixing system. Max load 250 kg (551 lb). Packing: 373x128x410 mm (27735) 373x165x410 mm (27737)

Instructions: GB, IT, FR, ES, DE, PT, GR, SE, DK, PL, NL

## CONTACT PLUS SOFT RAISED TOILET SEATS

• **27743 CONTACT PLUS SOFT RAISED TOILET SEAT**  
• **27745 CONTACT PLUS SOFT RAISED TOILET SEAT - with lid**  
High quality soft toilet raiser, made of high-density foam injected in a waterproof PVC skin. It fits any toilet bowl in a very secure way. This comfortable seat with ergonomic shape and high density foam, raises the toilet by 11 cm (4.3 inches). Tested for 185 kg (407 lb).

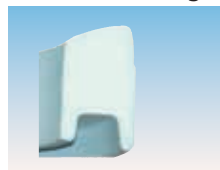

Cross section view



Exclusive comfort

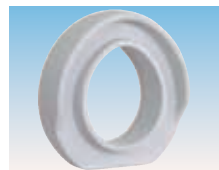

Fits most toilet bowls



**27743**

MADE IN FRANCE

Dimension	width	depth	height
Outside	37 cm	41 cm	16 cm
Inside	21 cm	26 cm	16 cm



**27745**

## WC - SHOWER COMMUNE



Weight: 5.5 kg  
Load: 100 kg

38 cm

Height adjustable  
83 - 93 cm

Height adjustable  
**27758**  
45 - 55 cm

**27759**

48 cm 45 cm

• **27758 BATH BENCH** with backrest Aluminium frame and padded seat. Removable plastic bowl WC.

• **27759 WC - SHOWER COMMUNE** Suitable also as raised toilet seat. Adjustable height 45-55 cm (back 78-88 cm)  
• **27766 PLASTIC WC BOWL** - spare

## CLIPUP® TOILET RAISER



Delivered with 6 antislip SBS pads.

Patented fastening system with ratchet

MADE IN FRANCE



**27738**

• **27738 CLIPUP® TOILET RAISER** - autoclavable ClipUp® can be installed safely on any type of toilet bowl. Innovating fixation system with ratchet. Design with front cutout provides optimal comfort and facilitates personal hygiene. Max Load 150 kg.

### TECHNICAL SPECIFICATIONS

Size: width 34 to 37 cm	Seat opening (depth x width): 26x16 to 19 cm
depth 38.5 cm	Toilet elevation: 10 cm
height 14 cm	Weight: 0.872 kg
Packing: 45.5x16.5x 39.5 cm	Material: 100% polypropylene



## COMMODOE WHEELCHAIRS

Packing size:  
54.5x19x76 cm  
Weight: 7.7 kg



**43196**  
4 castors Ø 10 cm  
(4 ")

Packing size:  
72x58x36 cm  
Weight: 8.8 kg



**43198**  
4 castors Ø 10 cm  
(4 ")

• **43196 BLUE COMMODOE WHEELCHAIR**  
• **43198 SMART COMMODOE WHEELCHAIR**  
Made of aluminium with anodized surface. Fixed height. Equipped with 4 castors with brakes, one large footrest, and pan with lid. Indoor use.  
Multilingual manual: GB, FR, IT, ES, PT, DE.

GIMA code						
43196	82	92	56.5	51	46	45
43198	96	100	60	53	52	50

## ELITE COMMODOE



**43203**

Size:  
54x88x105 cm  
Weight: 21 kg  
Load: 100 kg

**43203**  
Supplied with plastic pan



4 wheels Ø 20 cm (2 with brake)

• **43203 ELITE 200 COMMODOE - 43 cm**  
• **43204 ELITE 200 COMMODOE - 53 cm**  
- chromed steel frame  
- blue, washable, flame retardant leatherette  
- adjustable length and raising footrest  
- removable armrest - reclining backrest

## COMMODOE CHAIRS

• **27701 COMMODOE CHAIR - chromed steel**  
Chromed steel chair frame, with plastic detachable commode seat.  
• **27702 COMMODOE WHEELCHAIR - painted**  
Powder coated steel frame, detachable armrest and footrest, solid rear castors with lock, plastic commode seat.  
• **27703 COMMODOE WHEELCHAIR - stainless steel**  
Stainless steel chair frame, detachable armrest and footrest, rear castors with lock, plastic commode seat.  
Multilingual manual: GB, FR, IT, ES.  
• **27699 FOOTREST for 27702 - pair**  
• **27700 FOOTREST for 27703 - pair**  
• **27766 PLASTIC WC BOWL - spare - Ø 26xh 15 cm**



**27701**



**27702**



**27703**

GIMA code												
27702/3	55	44	12.5	12.5	51	88	90	44	42	100	54x53x53	17 18
27701	56	44			47	94		43	38	100	50x19x75	8.5

## COMMODOE AND SHOWER CHAIR

• **43193 COMMODOE AND SHOWER CHAIR**  
3 in 1 aluminium lifting chair which can be used as raised toilet seat, commode chair and shower chair. Designed with spring-loaded uplift mechanism and safety lock, that help users to stand up, pushing on the armrests. Self-powered, lean forward armrests for easy exit. Anti-slip tips with height adjustable legs.  
Delivered with bucket, bucket cover and splash-shield.  
Multilingual manual: GB, FR, IT, ES, PT, DE, SE, GR.

Cushion and backrest made of waterproof durable quality PU foam

**3 IN 1:  
COMMODOE CHAIR,  
SHOWER CHAIR  
TOILET RAISER**



**43193**

Adjustable seat height

Spring-loaded uplift mechanism

Self powered, lean forward armrest for easy exit

Rugged, rust-proof aluminium frame

**TECHNICAL SPECIFICATIONS**  
Width: 52-55.8 cm  
Depth: 69.2-73 cm  
Height: 85-95.5 cm  
Packing: 64.5x58.5x39.5 cm  
Max load: 136 kg - Weight: 7.1 kg

## COMFORT COMMODOE

• **43190 COMFORT COMMODOE CHAIR - blue**  
• **43191 COMFORT COMMODOE CHAIR - height adjustable - blue**  
Padded and removable seat for best comfort and high level of hygiene.  
Pan is removable from both sides and from the top.

MADE IN FRANCE

**MAX LOAD 130 kg**

**TECHNICAL SPECIFICATIONS**

Total height: 86 or 86/97 cm  
Width between armrests: 51.5 cm  
Total width: 60.5 cm  
Height armrest-floor: 72 or 72/83 cm  
Height seat-floor: 52 or 52/63 cm  
Height seat-backrest: 38 cm  
Seat plate depth: 39 cm  
Total depth: 58 cm



**43191**

Weight: 6.8 kg

## QUALITY STICKS



### BEECHWOOD STICKS:

- 27760 GIOTTO CURVED HANDLE - man - brown
  - 27761 GIOTTO CURVED HANDLE - woman - brown
  - 27762 RAFFAELLO "T" HANDLE - man - brown
  - 27763 RAFFAELLO "T" HANDLE - woman - brown
  - 27734 RAFFAELLO "T" RIGHT HANDLE - unisex - turtle
  - 27764 TIZIANO CURVED HANDLE - unisex - horn style
  - 27765 TIZIANO "T" HANDLE - unisex - horn style
  - 27768 LEONARDO METAL CURVED HANDLE - unisex - black
  - 27736 LEONARDO METAL ENGRAVED "T" HANDLE - unisex - black
  - 27772 TIEPOLO CHROMED "DUCK" HANDLE - unisex - black
- Max load for wooden sticks: 100 kg. Height: 92 cm\*.  
\*Can change from 90 to 96 cm depending on rubber tip and handle

## WALKING STICKS



- 27779 "T" HANDLE ALUMINIUM WALKING STICK - bronze  
Adjustable height: 72-94 cm - weight 0.4 kg - max load 120 kg
- 27780 "T" HANDLE ALUMINIUM WALKING STICK - silver  
Adjustable height: 71-94 cm - weight 0.36 kg - max load 100 kg
- 27781 "T" HANDLE ALUMINIUM WALKING STICK - black  
Adjustable height: 67-90 cm - weight 0.3 kg - max load 100 kg
- 27782 FOLDABLE ALUMINIUM WALKING STICK - coffee  
Adjustable height: 80-90 cm - weight 0.37 kg - max load 100 kg
- 27783 FOLDABLE ALUMINIUM WALKING STICK - cashmere pattern  
Adjustable height: 86-96 cm - weight 0.36 kg - max load 110 kg
- 27784 CURVED HANDLE ALUMINIUM WALKING STICK  
Adjustable height: 77-100 cm - weight: 0.32 kg - max load 100 kg
- 27795 RUBBER FERRULES int. Ø 19 mm - grey for 27780-2, 27793 - bag of 5
- 27796 RUBBER FERRULES int. Ø 12 mm - grey for 27790, 43070 - bag of 5

## QUALITY STICKS

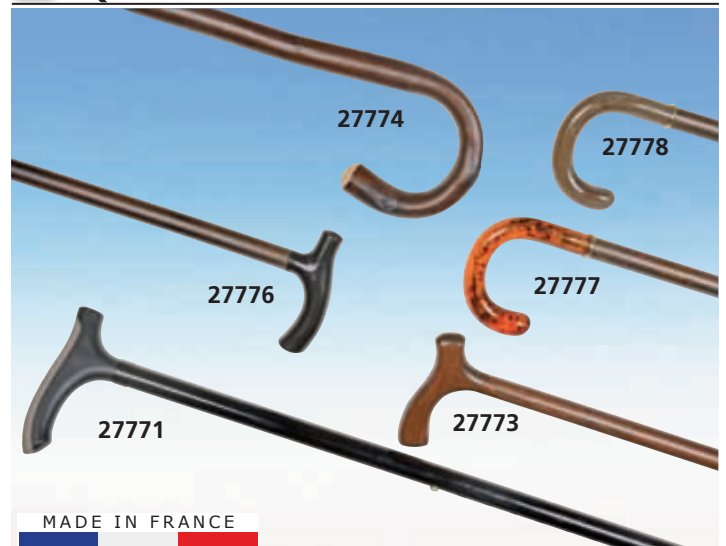

### WOODEN STICKS

- 27773 "T" HANDLE - wooden - max load 120 kg
- 27774 CROOK - chestnut - max load 100 kg

### SYNTHETIC STICKS

- 27776 "T" HANDLE - black - load 120 kg
- 27777 CROOK - amber style - load 100 kg
- 27778 CROOK - horn style - load 100 kg

### ALUMINIUM WALKING STICK

- 27771 "T" ADVANCE - grey  
Aluminium height adjustable cane 745-975 mm with comfortable gel-grip to reduce hand stress. Max load 110 kg.



## SPARE RUBBER TIPS



**SPARE TIPS FOR STICKS, CRUTCHES, TRIPODS AND QUAD CANES**  
Wide range of spare tips that improve performance in term of comfort, grip, durability and adaptability to the ground.

RUBBER TIPS				
GIMA code	Tube	Base	Material	Minimun order
43080	Ø 16 mm	Ø 35 mm	thermoplastic rubber	bag of 10
43081	Ø 16 mm	Ø 35 mm	thermoplastic rubber	bag of 10
43082	Ø 19 mm	Ø 35 mm	thermoplastic rubber	bag of 10
43083	Ø 19 mm	Ø 40 mm	thermoplastic rubber	bag of 10
43084	Ø 19 mm	Ø 45 mm	thermoplastic rubber	bag of 10
43085	Ø 19 mm	Ø 47 mm	pure rubber	bag of 2
43086	Ø 19 mm	Ø 55 mm	pure rubber	bag of 2
43087	Ø 16/22 mm	Ø 40 mm	thermoplastic rubber	bag of 2

## SAFETY STRAP

- 43096 UNIVERSAL SAFETY STRAP  
Adaptable safety strap. Button lock.



## SKID-PROOF STICKS WITH LIGHT

- 43044 TRUSTY CANE - silver
  - 43045 TRUSTY CANE - black
- Sturdy, folding cane with built-in lights and extra wide pivoting head with 3 firm and skid-proof bases. Height adjustable 85-97 cm. Large base with Ø 9 cm. Shaft in aluminium (thickness 1.2 mm) Handle in ABS (15 cm). Weight 420 g. Need 3x1.5 V AAA batteries not included.
- 43048 FOOT PADS - kit of 3 - spare



## STICKS WITH LIGHT AND ALARM



## QUADRIPODS AND STICK WITH SEAT



- 43060 STICK WITH SEAT - silver
- Aluminium walking stick with seat, height 84 cm, weight 0.9 kg
- 43065 TRIPOD - silver
- Adjustable height 74-97 cm, weight 0.8 kg
- 43070 QUADRIPOD Q1 with PU handle - aluminium - silver
- Adjustable height 74-97 cm, weight 0.9 kg
- 43071 QUADRIPOD Q2 with small base and PU handle - silver
- Adjustable height: 65-88 cm, weight 0.8 kg
- 43072 QUADRIPOD Q3 with PU handle - bronze
- Adjustable height: 70-88 cm - weight 0.5 kg
- Maximum load for tripod and quadripods: 100 kg
- 27796 RUBBER FERRULE int. Ø 12 mm - grey for 43065, 43070/72 - bag of 5
- Universal rubber ferrule
- Ø 22 mm 27797
- Ø 19 mm 27795
- Ø 12 mm 27796

## CANE, TRIPOD, QUAD CANE

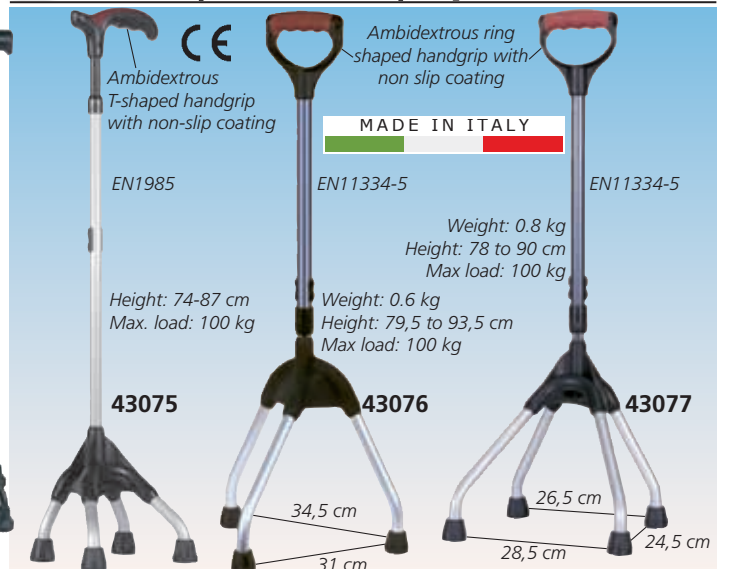

- CANE, TRIPOD AND QUAD CANE WITH ADJUSTABLE HEIGHT**
- Walking aids for people who need to relieve the weight from the legs providing stability, higher than a traditional stick.
- 43075 STABLE WALKING CANE
  - 43076 TRIPOD WITH RING HANDGRIP
  - 43077 QUAD CANE WITH RING HANDGRIP
- Stick Structure:** all the bases and the upper sliding tube are in light aluminium alloy. For the quad cane the central tube is made of steel. U-shaped tubes with strong injection-moulded plastic joint to provide strength and stiffness of the base (only 43076-7).
- Tube Locking clip:** locking of the telescopic tubes with a clip equipped with a double pin; this improves the safety.
- Tapered ring nut:** supplied with a tapered ring nut allowing, by tightening, to eliminate noise.
- Tips:** high grip and have Ø of 35 mm, ISO EN 11334-4. Tip made of high friction material (only 43075)
- Class I Medical Devices 93/42/EEC.

## ELBOW CRUTCHES

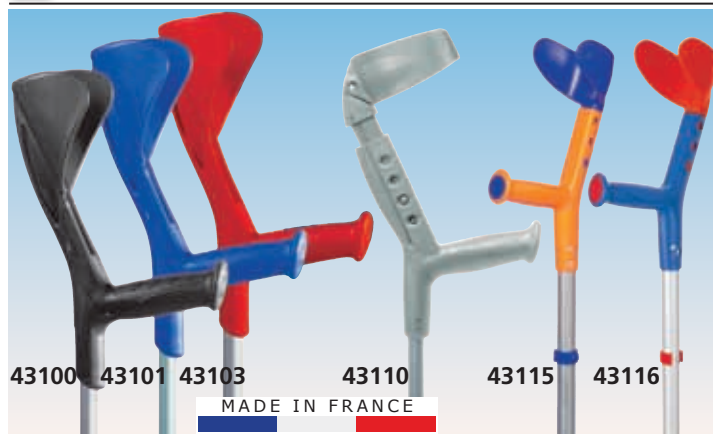

- 43100 EVOLUTION CRUTCHES - black - pair
  - 43101 EVOLUTION CRUTCHES - blue - pair
  - 43103 EVOLUTION CRUTCHES - red - pair
- Ergonomic handle and brachial support to enhance safety and quality of arm support while moving around. Aluminium pipes are in light grey anodised finish.
- 43110 PROGRESS 2 CRUTCHES - light grey/grey - pair
- For tall and heavy-weight adults, the handle adjusts from 22 to 29 cm. This crutch is suitable for adults whose height is comprised between 160 and 215 cm.
- 43115 TIKI CRUTCHES - blue/orange - pair
  - 43116 TIKI CRUTCHES - red/blue - pair
- For children or teenagers. The handle adjusts from 16 to 21 cm.
- 43120 RUBBER PVC FERRULES inside Ø 19 mm - grey - bag of 10

### TECHNICAL SPECIFICATIONS

Model	EVOLUTION	PROGRESS 2	TIKI
Weight kg:	0.5	0.5	0.35
Height handle to floor cm:	77-98	79-101	55-77
Material of handle:	Polypropylene		
Diameter upper/down pipe mm:	22/19	22/19	22/19
Number of adjustment of height:	10 times adjustable every 20 mm		
Finishing/material:	grey anodization/aluminium		
Certified and tested for kg:	130	150	100
Standard used for testing:	EN ISO 11334-1		
Adjustable handgrip:	-	4 times	3 times
Handgrip size: Ø x l x h mm	35x100x235	35x100x220/290	32x100x160/210

## ADVANCE ELBOW CRUTCHES

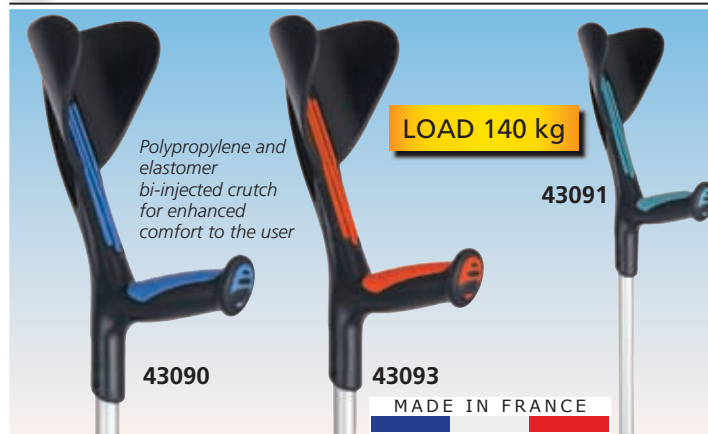

- 43090 ADVANCE CRUTCHES - blue/black - pair
  - 43091 ADVANCE CRUTCHES - turquoise/black - pair
  - 43093 ADVANCE CRUTCHES - red/black - pair
- Advance is the first polypropylene and elastomer bi-injected crutch, bringing enhanced comfort to the user. Certified and tested up to 140 kg. Adjustable in height 10 times per clip. Integrated anti-noise cap and Pivoflex tip.
- 43121 PIVOFLEX TIP - box of 10 - spare
- Inner Ø 19 mm, outer Ø 40 mm.

### TECHNICAL SPECIFICATIONS

Weight kg:	0.51
Height handle to floor cm:	77-98 cm
Material of handle:	polypropylene and elastomer
Number of adjustment of height:	10
Tube finishing/material:	anodized aluminium
Certified and tested for kg:	140
Handgrip length cm:	10



**43121**  
High quality tip  
anti-noise

## DOUBLE ADJUSTMENT CRUTCHES



- 43123 DOUBLE ADJUSTMENT CRUTCH - open - pair
  - 43124 DOUBLE ADJUSTMENT CRUTCH - closed - pair
- Designed to improve comfort for people. Optimized handgrip and support angles, in order to achieve an advanced body posture and reduce hand and forearm fatigue. Structure made of light aluminium alloy. Adjustable forearm 22-28 cm. Open or closed arm cuff. The locking of the telescopic tubes is achieved with a clip equipped with a double pin, to improve safety. Tapered ring nut: it allows, by tightening, to eliminate noise.
- 43126 AMBIDEXTROUS HANDGRIP - spare

### TECHNICAL SPECIFICATIONS

Weight:	0,58 kg (43123) - 0,62 kg (43124)	Height: 68-98 cm
Material:	Aluminium alloy	Forearm support: 22-28 cm
Max. load:	150 kg	
Class I Medical Device, 93/42/EEC, ISO EN 11334-1		

## T-BAR AND UNDERARM CRUTCHES

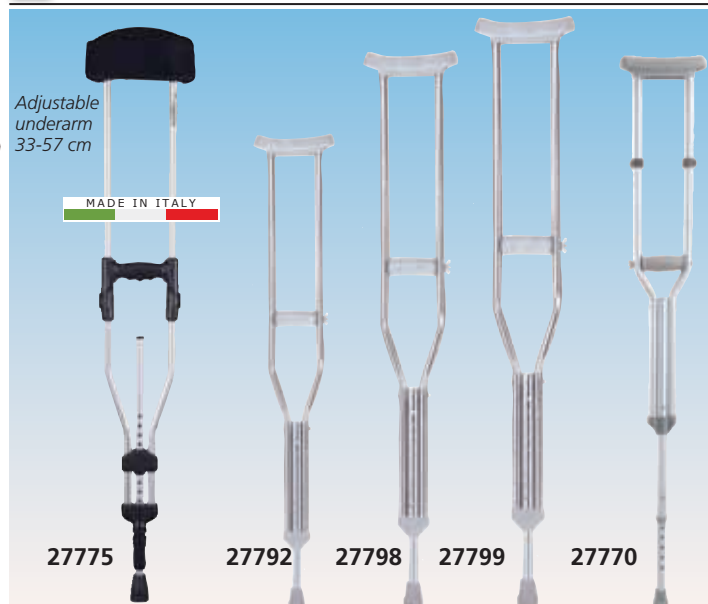

- 27775 DOUBLE ADJUSTMENT UNDERARM CRUTCH - pair
- Light aluminium alloy. Out of center handgrip and washable cover 120-142 cm. Weight 1 kg. Max load 100 kg.
- 27792 T-BAR CRUTCH - small
- Stainless steel type. Adjust. height: 95-115 cm. Max load 100 kg.
- 27798 T-BAR CRUTCH - medium
- Stainless steel type. Adjust. height: 112-132 cm. Max load 100 kg.
- 27799 T-BAR CRUTCH - large
- Stainless steel type. Adjust. height: 119-139 cm. Max load 100 kg.
- 27770 T-BAR CRUTCH - extra adjustability
- Aluminium crutch with adjust. height 100-130 cm. Max load 100 kg.
- 27797 RUBBER FERRULES int. Ø 22 mm grey for 27792/8/9 - bag of 5

## WALKING FRAMES



• **27721 WALKING FRAME - 2 WHEELS**  
Intended to provide support to the patient. It allows mobility making it easy to walk.  
Size 54x57 cm with adjustable height 52-87 cm.  
Instructions: GB, FR, IT, SE.  
Weight: 8 kg - Load: 100 kg.

• **27722 WALKING FRAME**  
Made of lightweight aluminium tubing, non-slip end and padded handgrips.  
Size 47x60 cm foldable with adjustable height 78-96 cm. Instructions: GB, FR, IT, SE.  
Weight: 2.4 kg - Load: 100 kg.

• **27794 RUBBER FERRULES Ø 28 mm - grey** for 27722-3 - bag of 5 pcs.



## WALKING FRAMES WITH WHEELS



• **27723 WALKING FRAME - 2 WHEELS**  
Made of lightweight aluminium tubing, with padded hand grips, 2 non-slip ends and 2 with wheels. Size 51x64 cm, foldable with adjustable height 79-97 cm.  
Instructions: GB, FR, IT, SE.  
Weight: 3 kg - Load: 100 kg.

• **27794 RUBBER FERRULES Ø 28 mm - grey** for 27722-3 - bag of 5 pcs.

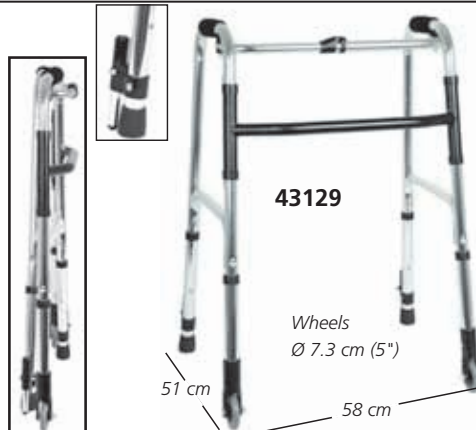

• **43129 WALKING FRAME - 2 INTERNAL WHEELS**  
Made of lightweight aluminium tubing with padded handgrips, 2 non-slip ends and 2 with wheels. Foldable. Adjustable height 80-90 cm.  
Instructions: GB, FR, IT, SE.  
Weight: 2.5 kg - Load: 100 kg.  
Size 51x58 cm.



• **43130 WALKING FRAME - 4 WHEELS**  
Made of lightweight aluminium tubing, 2 front swivel wheels, 2 rear wheels with stop, with foam grips.  
Size 55x65 cm foldable with adjustable height 83-93 cm.  
Instructions: GB, FR, IT, SE.  
Weight: 3.5 kg. Load: 100 kg.

## AXILLARY WALKING FRAME



• **43134 AXILLARY WALKING FRAME - 4 WHEELS - blue**  
Walking frame made of steel with 4 wheels and 2 brakes. Equipped with removable seat pad and soft PU foam arm pad.  
Height adjustable armrests 114-139 cm.  
Height adjustable back support 95-110 cm.  
Foldable: 15.5 cm width.  
Frame size: 71x54.5x h 71 cm.  
Max load: 130 kg.  
Weight: 10.5 kg.

## STAND UP ROLLATOR

• **43172 FULLY ADJUSTABLE STAND UP ROLLATOR**  
It helps adults to stand upright and look ahead with better support.  
Compact one hand folding design, aluminum stable frame, dual hand brake system and fully adjustable armrest, backrest and length.  
Detachable front wheels and stand up handles.  
Padded seat and backrest for more comfort.  
Two front (Ø 25.4 cm) and two rear (Ø 20.3 cm) PVC wheels, cane holder and shopping bag.  
Packing size: 78x28.5xh 45 cm  
Weight: 12 kg. Load: 136 kg.



# ROLLATORS



Closed size  
59x26.5x68 cm  
without  
handles

43140

Wheels  
Ø 20 cm (8")

Multilingual  
instructions:  
GB, FR, IT, SE

- **43140 3 WHEELS ROLLATOR - blue**  
Blue painted steel, adjustable height frame. With 3 solid castors (2 fixed rear with brake and 1 swivel front). Supplied with shopping basket and tray. Weight: 7.7 kg - Load: 100 kg.
- **43142 IDEAL ROLLATOR - blue**  
Powder coated steel, adjustable height and foldable frame. With 4 solid castors (2 fixed rear and 2 swivel front). Ergonomic handgrip and hand brakes. Supplied with PU foam seat, reflector stickers, shopping basket and tray. Weight: 10.8 kg - Load: 120 kg. Carton size: 590x255x715 mm.
- **43141 CANE HOLDER for 43142**



Adjustable  
height  
78-97 cm

Tray 39x25 cm

CE

43142

Wheels  
Ø 20 cm (8")

Multilingual  
instructions:  
GB, FR, IT, ES



Multilingual  
instructions:  
GB, FR, IT, SE

CE

Weight 7.4 kg  
Load: 100 kg

27724

Front pivoting castors:  
Castors Ø 20 cm (8")

68 cm

61 cm

- **27724 COMFORT ROLLATOR WITH SEAT**  
Foldable frame with seat, large front basket and brakes on wheels. Size 68x61 cm. Adjustable height 78-90 cm. Seat at 46 cm. Seat size: 32x35x4 cm.



Multilingual  
instructions:  
GB, FR, IT, SE

CE

43143

Weight 7.4 kg  
Load: 100 kg

- **43143 SILVER ROLLATOR WITH SEAT**  
Foldable frame with seat, large front basket and brakes on rear wheels. Size 68x61 cm. Adjustable height 78-90 cm.



Weight:  
6.8 kg  
Load:  
136 kg

CE

Adjustable handle  
height 85.5-101 cm

Seat 37x25 cm with  
four adjustable  
heights: from  
53 to 60 cm

43160

PVC wheels  
Ø 20 cm (8")

Multilingual  
instructions:  
GB, FR, IT, ES

- **43160 LIGHTWEIGHT ROLLATOR - foldable**  
Lightweight blue aluminium frame with PP comfortable, adjustable height seat. Handy up seat, padded backrest foldable up and down, wheeled detachable legs. Loop brakes for more safety. Size 56x77 cm. Packing dimension 60x18x58 cm.

## ATTRACTIVE, LIGHTWEIGHT ALUMINIUM ROLLATORS WITH SEAT



Push button height  
adjustment on  
handles 79.5-93 cm

Weight:  
8.5 kg  
Load:  
136 kg

Seat 46x25 cm  
at 54 cm height

43162

Weight: 8.1 kg  
Load: 136 kg

PVC wheels  
Ø 20 cm (8")



Push button height  
adjustment on  
handles 79-92 cm

Seat 46x25 cm  
at 53 cm height

43164

PVC wheels  
Ø 20 cm (8")



79 cm

25 cm

Seat 25x45 cm  
at 55 cm height

43166

PU rear wheels  
Ø 20 cm (8")

Load: 136 kg  
Weight: 8 kg

Comfortable belt filled  
with sponge.

92 cm

55 cm

PU swivel  
front wheels  
Ø 25 cm (10")

70 cm

63 cm

- **43166 PRINCE ROLLATOR - foldable**  
Multifunctional aluminium rollator with silver PU wheels. Equipped with large swivel front and detachable rear wheels, handle height adjustment with brake, cane holder and shopping bag. Packing size: 59x44x21 cm. Multilingual manual: GB, FR, IT, ES.

- **43162 COMPACT ROLLATOR - foldable**  
Lightweight red aluminium frame, mesh cloth seat with pull up strap. Ergonomic handle and loop brakes for more safety. Cane holder. Two front revolving and fold-up wheels, two rear legs fold up for a very compact folded size. Size 64x66.5 cm. Packing dimension 66x29x37 cm. Multilingual manual: GB, FR, IT, ES.

- **43164 STYLISH ROLLATOR - foldable**  
Lightweight silver aluminium frame, foam padded nylon seat with pull up strap. Ergonomic handle and loop brakes for more safety. Hidden brake cable. Cane holder. Quick release front wheel, rear tubes fold up without any screw for a very compact folded size. Size 66x73 cm. Packing dimension 66x29x37 cm. Multilingual manual: GB, FR, IT, ES.

# LIGHTWEIGHT ALUMINIUM FOLDING WHEELCHAIRS



- **27708 PAEDIATRIC WHEELCHAIR** - 35 cm seat - black tissue
- single cross bar
- padded flip-up armrest
- fixed footrest, flip-up foot plate with leg strap
- 15 cm (6") solid front castors
- 56 cm (22") pneumatic rear wheels
- locking brakes on rear wheels
- folding back
- large pocket on the back



- **43250 QUEEN ALUMINIUM WHEELCHAIR** - 46 cm seat - light blue tissue
- double cross bar
- extra light aluminium frame only 9.5 kg
- fixed armrest, cloth pad
- fixed flip-up footrest with leg strap
- 15 cm (6") front solid castors
- 30 cm (12") pneumatic rear wheels
- folding back
- locking brakes on rear wheels



- **43251 PRINCE ALUMINIUM WHEELCHAIR** - 46 cm seat - black tissue
- double cross bar
- fixed armrest, PU pad
- flip-up footrest with leg strap
- locking brakes on rear wheels
- 51 cm (20") PU rear wheels
- 15 cm (6") solid front castors
- folding back
- pocket on the back
- safety belt included



- **43235 CLASSIC ALUMINIUM WHEELCHAIR** - 46 cm seat - black tissue
- double cross bar
- padded flipback armrest
- detachable footrest, flip-up plastic plate with leg strap
- 20 cm (8") solid PU front castors
- 61 cm (24") solid PU rear wheels with quick release axles



- **27720 KING ALUMINIUM WHEELCHAIR** - 46 cm seat - black tissue
- double cross bar
- flip-up and height-adjustable armrest, PU pad
- detachable footrest, flip-up plate with leg strap
- 61 cm (24") pneumatic rear wheels with quick release axles
- 15 cm (6") solid front castors
- anti tipper system with 2 small wheels and 2 carrying wheels



- **27717 DELUXE WHEELCHAIR** - 46 cm seat - black tissue
- double cross bar
- flip-up height adjustable armrest, PU pad
- detachable footrest, flip-up plate with leg strap
- 61 cm (24") solid PU rear wheels
- 15 cm (6") solid front castors
- locking brakes on rear wheels
- anti tipper system with 2 small wheels

Wheel chair	SPARE - ACCESSORIES				Icons												W (kg)	DIM	NW	GW
	Rear wheel	Front wheel	Foot-rest pair	IV stand	1	2	3	4	5	6	7	8	9	10	11	12				
27708	27742	-	27710	27705	52	32	35	56	15	48	90	97	36	40	75	85x33x73	13	15		
43250	43252	43253	43254	-	60	29.5	46	30	15	48	90	100	-	-	100	71x28x72	9.5	11		
43251	43248	27789	43249	27705	63	29.5	46	51	15	48	91	-	-	-	100	84x31x74	11.8	13.5		
43235	43239	43238	43237	-	64	37	46	60	20	46	96	103	42	45.5	120	82x31x96	13	14.5		
27720	27787	27791	27728	27705	63	-	46	61	15	50	89	-	-	-	100	83x28x91	17.2	19.4		
27717	27748	27791	27714	27705	67	36	46	61	15	51	91	105	40	45	100	80x33x93	17	19		

# FOLDING STEEL WHEELCHAIRS



**ECONOMIC**

43220



43225



**MAX WIDTH 51 cm**

**FOLDED WIDTH 30 cm**

Wheelchair passing through narrow transit areas

43230

- 43220 VALUE WHEELCHAIR - 41 cm seat - nylon black tissue
- double cross bar
- fixed armrest, PVC pad
- fixed footrest, flip-up plate, with leg strap
- 20 cm (8") solid front wheels
- 61 cm (24") solid rear wheels
- locking brakes on rear wheels
- pocket on the back



43220

- 43225 TRANSIT WHEELCHAIR - 46 cm seat - black tissue
- double cross bar
- fixed armrest, PVC pad
- fixed footrest, flip-up plate, with leg strap
- 15 cm (6") solid front wheels
- 30 cm (12") pneumatic rear wheels
- locking brakes on rear wheels
- handles brakes for rear wheels
- folding back
- pocket on the back



43225

- 43230 NARROW WHEELCHAIR - 41 cm seat - black tissue
- single cross bar
- fixed armrest, PU pad
- detachable footrest, flip-up plate, with leg strap
- 20 cm (8") solid front wheels
- 52 cm (20") pneumatic rear wheels
- locking brakes on rear wheels
- adjustable distance from foot plate to front seat 46-56 cm
- pocket on the back



43230



27709



27715



27716

- 27709 STANDARD WHEELCHAIR - 46 cm seat - blue tissue
- single cross bar
- chromed frame
- fixed armrest, PVC pad
- fixed footrest, flip-up plate with leg strap
- 20 cm (8") solid front castors
- 61 cm (24") solid rear wheels
- locking brakes on rear wheels
- large pocket on the back



27709

- 27715 ROYAL WHEELCHAIR - 46 cm seat - black tissue
- double cross bar
- chromed steel frame
- flip-up armrest, PU pad
- detachable footrest, flip-up plate with leg strap
- 61 cm (24") pneumatic rear wheels with quick release system
- 15 cm (6") solid front castors
- locking brakes on rear wheels
- folding back
- large pocket on the back



27715

- 27716 EXTRA LARGE WHEELCHAIR - 56 cm seat - black tissue
- double cross bar
- powder coated steel frame
- super width 56 cm seat
- flip-up armrest, PU pad
- detachable footrest, flip-up plate with leg strap
- 20 cm (8") rubber foam front castors
- 61 cm (24") pneumatic rear wheels
- large pocket on the back



27716

Wheel chair	SPARE - ACCESSORIES					Icons												DIM	NW	GW
	Rear wheel	Front wheel	Foot-rest pair	IV stand	Table*	1	2	3	4	5	6	7	8	9	10	11	12			
43220	43221	43222	43223	-	-	59	27	41	59	20	47	86					100	95x27x93	15	17
43225	43226	43227	43228	27705	-	63		46	53	15	49	91					100	76x30x76	14	16.3
43230	43231	43232	43233	-	-	51	30	41			56	98.5	100	45	38	100	77x31x100	15.8		
27709	27744	27788	27711	27705	27706	64	24	46	58	20	49	87	106	40	45	100	94x23x89	17	19.2	
27715	27746	27789	27712	27705	-	64	28	46	61	15	51	94	106	40	45	100	80x28x78	15.8	18.6	
27716	27747	-	27713	27705	27706	73	32	56	62	20	54	93	109	45	46	125	83x33x93	21.5	24.1	

\* Size of table: 32x55 cm



## ESSEX FOLDING WHEELCHAIRS



- 43260 ESSEX WHEELCHAIR - 43 cm - black tissue
- 43261 ESSEX WHEELCHAIR - 46 cm - black tissue
- 43262 ESSEX WHEELCHAIR - 51 cm - black tissue

- blue powder coated steel frame
- rear solid PU wheels Ø 30.5 cm (12")
- front solid PU wheels Ø 20 cm (8")
- locking brakes on rear wheels
- front powder steel fork
- padded flip-up armrests
- detachable aluminium footrests with 6 height adjustable clips, flip-up plate, heel straps
- black nylon seat and back

Manual: GB, FR, IT, ES, PT, DE, GR, SE.



Double cross braces (only for code 43262)



GIMA code ACCESSORIES FOR ESSEX  
43263 Aluminium footplate - pair - spare

Wheelchair	Seat			Wheels			Height		Weight		DIM		NW GW	
43260	58	25	43	30.5	20	50	91	96	40	41	110	76x25x93	16	18
43261	61	25	46	30.5	20	50	91	96	40	41	110	76x25x93	16	18
43262	66	25	51	30.5	20	50	91	96	40	41	110	76x25x93	16	18

## OXFORD FOLDING WHEELCHAIRS



Black nylon seat and back



- 43270 OXFORD WHEELCHAIR - 43 cm - black tissue
- 43271 OXFORD WHEELCHAIR - 46 cm - black tissue
- 43272 OXFORD WHEELCHAIR - 51 cm - black tissue

- blue powder coated steel frame
- pneumatic rear wheels Ø 61 cm (24") with chromed steel handrim and quick release axles
- front solid PU wheels Ø 20 cm (8")
- locking brakes on rear wheels
- front powder steel fork
- padded flip-up armrests
- detachable footrests, flip-up plate, with leg straps

Manual: GB, FR, IT, ES, PT, DE, GR, SE

- 43274 OXFORD PLUS WHEELCHAIR - 46 cm - black tissue
  - 43275 OXFORD PLUS WHEELCHAIR - 51 cm - black tissue
- Same features as above, but with solid PU rear wheels Ø 61 cm (24") and anti tipper system.

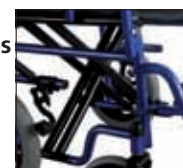

Double cross braces (only for codes 43272 and 43275)



Quick release system

GIMA code ACCESSORIES FOR OXFORD  
43276 Plastic footplate - pair - spare  
43277 Pneumatic rear wheel - spare for 43270-2  
43278 Solid PU rear wheel - spare for 43274-5



Anti tipper system for 43274-5

Wheelchair	Seat			Wheels			Height		Weight		DIM		NW GW	
43270	60	26.5	43	61	20	50	91	103	40	44	120	82x27x93	18	20
43271, 43274	63	26.5	46	61	20	50	91	103	40	44	120	82x27x93	18	20
43272, 43275	68	26.5	51	61	20	50	91	103	40	44	120	82x27x93	18	20

## FOLDABLE COMMODOE WHEELCHAIR



43283

- 43283 COMMODOE WHEELCHAIR

Chrome steel structure device ideal for patients with low mobility. It has fixed armrests and footrests, solid castors and sturdy rear wheels. U shape commode seat is extremely durable, suitable for indoor use. Supplied with toilet bowl.

Rear wheels diameter: 58 cm (22").

Front castors diameter: 20 cm (7").

- 27744 SOLID REAR WHEEL - spare
- 27766 PLASTIC WC BOWL Ø 26xh 15 cm - spare
- 43285 PLASTIC FOOT PLATE - pair - spare

Wheelchair	Seat			Wheels			Height		Weight		DIM		NW GW	
43283	64	44	58	20	50	87	105	37	100	92x29x89	19	21,3		

## ELECTRIC WHEELCHAIRS - FOLDABLE

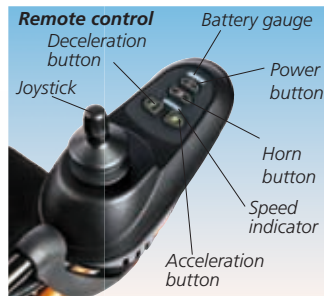

- **43290 ELECTRIC WHEELCHAIR - 30 cm rear castors**
  - **43291 ELECTRIC WHEELCHAIR - 56 cm rear wheels with handrail**
- Electric wheelchair, for daily indoor and outdoor use. It can be used in electric or manual mode, for easy clutch switching. User can move wheelchair forwards, backwards or turn around through an intelligent controller, complete with joystick to control speed and direction. It is provided with aluminium alloy frame, hand rest, foot rest, expandable arm rest and flexible shock-proof suspension. Removable seat and backrest cushions, battery and remote control.
- Comfortable driving** with ergonomic design which relieves fatigue.
- Powerful:** efficient energy-saving motor; high-precision gearbox; fast and stable starting. 5 speed settings.
- Triple protection:** electromagnetic brake and gear self-lock protection.
- Stylish model:** smooth light design characterized by dynamic guard plate, split fixed seat and patented arc-shaped foot rest. Backrest folding mechanism.
- Supplied with lithium battery and charger, manual (GB, IT).
- **43292 LITHIUM BATTERY - spare for 43290-1**
  - **43293 PNEUMATIC FRONT CASTOR 20 cm (8") - spare for 43290-1**
  - **43294 PNEUMATIC REAR CASTOR 30 cm (12") - spare for 43290**
  - **43295 PNEUMATIC REAR WHEEL 56 cm (22") - spare for 43291**



TECHNICAL SPECIFICATIONS	
Load capacity:	≤100 kg
Enduranced mileage:	≥20 km
Maximum speed:	≤6 km/h
Battery:	lithium battery, DC 24V x 18Ah
Motor power:	130 W
Power consumption:	≤2.5 kw x h/100 km
Horizontal brake performance:	≤1.5 m
Maximum safe ramp brake:	≤3.6 m (6°)
Stability:	≥9° (static), ≥6° (dynamic)
Noise:	< 65 dB
Obstacle crossing height:	≥40 mm
Minimum turning radius:	1.2 m
Groove clearance width:	100 mm
Hill-holding performance:	9°
Size:	670 mm - open, 370 mm - closed (43290) 660 mm - open, 360 mm - closed (43291)
Seat width:	440 mm
Net weight:	26 kg (43290) - 29 kg (43291)
Protection:	IPX4

## PEDAL EXERCISERS

Compact exercise bikes for moderate cardiovascular workout. The regular use stimulates blood circulation and increases

muscle strength. Can be placed on a tabletop to exercise arms or on the floor as a bicycle-type exerciser while sitting.

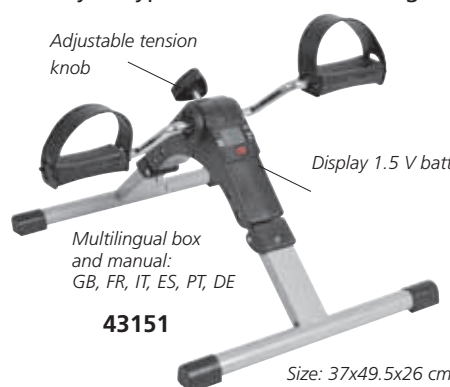
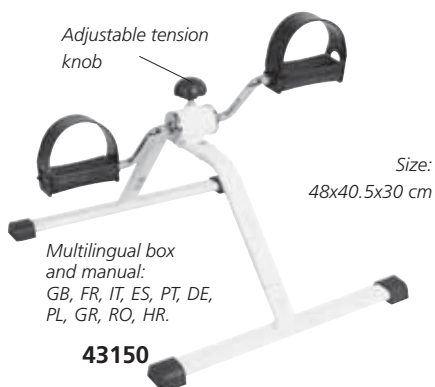

- **43150 BASIC PEDAL EXERCISER**  
Delivered in kit with screw and key for easy assembling.

- **43151 DISPLAY PEDAL EXERCISER**  
Foldable to save space. 5 function display: exercise time, rotation count, rotations per minute, calories burned and scan.

- **43152 ELECTRIC PEDAL EXERCISER WITH DISPLAY**  
Display indicator: scan, mode, calories, time, Reps, total Reps. It also includes a little controller to switch on/off the device and to control speed. Max. weight support: 120 kg  
Power 220 V - 50 Hz - 65 W.

## UNIVERSAL BELTS FOR ARMCHAIRS, COMMODES, WHEELCHAIRS

### SMART LINE (43216, 43217)

Padded harness and belt to prevent patient sitting on wheelchair from sliding forward. Equipped with two black propylene webbing (height 5 cm), adjustable up to 100 cm. One-hand release safety clip closure. Harness has two adjustable suspenders with sturdy strap. Class I, Medical Device. Washable at 30°.

Harness size: 60xh 37 cm, max. adjustable length: 260 cm. Belt size: 48xh 15 cm, max. adjustable length: 248 cm.

MADE IN ITALY



• 43216 ABDOMINAL BELT



• 43217 HARNESS

### PREMIUM LINE (43175, 43176, 43177)

Aids used for positioning and handling patients with safety. Equipped with button acetel closure to increase safety level and prevent it from releasing. Ideal for wheelchairs, commodes and armchairs (with 43178).

Coating in class 1 fire-retardant and water-repellent fabric. Washable at max. 40°

• 43178 EXTENDER FOR PREMIUM LINE BELTS - up to 150 cm

Adjustable length. Necessary for use with armchair.

MADE IN ITALY



• 43175 PELVIC BELT



• 43176 ABDOMINAL BELT



• 43177 HARNESS



Extra safe button closure

## BED RESTRAINT BELTS

100% cotton safety belts used for control of bedridden patient. Equipped with 1 (43185) or 3 (43186-7) safety locks that can be released with a special magnetic key. The belts allow a single (43185-7) or double (43186-7) movement to position the patient in a supine (43185-7) or lateral position (only 43186-7).

Washable at 90° (43185) or 95° (43186-7). Belt height 21 cm.

Safety locks and magnetic key



43185

MADE IN ITALY



43186, 43187



GIMA code	BED RESTRAINT BELTS	Size	Circumference cm
43185	Single movement belt	L-XL	80-122
43186	Double movement belt	S-M	60-88
43187	Double movement belt	L-XL	80-122

## TRANSFER BELT

- 43181 TRANSAC TRANSFER BELT - small
- 43182 TRANSAC TRANSFER BELT - medium

Polyurethane transfer belt to be placed around the patient's or the caregiver's waist, to help the patient sit or stand with minimum effort and maximum safety.

It has 5 vertical and 4 horizontal padded handles with polyester strap and nylon loop. Length: 105 cm (S), 120 cm (M). Transferring load: 160 kg. Washable at 60°.

43182



MADE IN FRANCE

## ROTATING SEAT CUSHION

- 43040 ROTATING SEAT CUSHION

Cushion to assist someone to turn easily in a car, on the bed or on the chair. Size: Ø 40 cm

43040



Slippery nylon filled with PU foam

Upper in 100% polyester



Bottom in non-slip PVC fabric

## PVC WATER MATTRESS

- 28502 PVC WATER MATTRESS

It helps movement and distributes pressure on the whole supporting surface. Double sealed seams provide maximum strength and durability.

Highly resistant PVC material construction easy to clean with any mild detergent. Air frame + 3 water elements.

Supplied with hand pump and hose.



28502

### TECHNICAL SPECIFICATIONS

Material: PVC 0.40 mm thickness  
Size of outer air frame: 200x93x11.5 cm  
Size of each element: 69x60x11.5 cm  
Weight: 3.5 kg

## SHAMPOO BASIN

- 28507 SHAMPOO BASIN

Inflatable shampoo basin ideal for personal in-bed hair care needs. It supports the head, neck and shoulders during shampooing. A 20 cm deep basin helps prevent splashing. Drain hose efficiently removes water and foam. Supplied with water bag with shower head in clip.

Size: 53x61x20 cm  
Capacity: 10 l

- 28509 WATER BAG - spare

28509

Bag for easy water transport when water source is not easily accessible



28507

# ANTI-DECUBITUS AIR MATTRESSES WITH PUMP - STAGE I AND II



**BASIC CARE STAGE I**  
Professional use  
Flaps length: 50+50 cm (top + bottom)  
130 cells  
**EN71 MEDICAL GRADE PVC**  
**28564**

**ALTERNATING BUBBLE MATTRESS**  
Designed for the treatment and prevention of pressure sore stage I in short-term and domiciliary therapies. The PVC mattress is composed of 130 7 cm-high bubble cells, particularly comfortable. Fixable to bed by extra flaps on both top and bottom side. Cold-resistant -30 degrees.  
**PUMP SYSTEM**  
Special silent pump for an excellent pressure regulation by a knob on the front panel. It can be hung to any kind of hospital bed frame by means of two adjustable hooks. For use with bubble or alternating cell mattresses. **28565**

**MODERATE CARE STAGE I, II**  
Professional use  
Cells (20+1 spare) are fixed by means of pressure stud and can easily be replaced in case of breakage  
**28567**

**ALTERNATING INTERCHANGEABLE CELL-MATTRESS**  
Recommended for the prevention and treatment of pressure sore stage I and II in medium-term and domiciliary therapies. The 20 9.5 cm-high Nylon+PVC cells provide superior comfort.

GIMA code	MATTRESSES AND PUMP
28564	Bubble mattress
28565	Pump for 28564
28566	Kit bubble mattress+pump (28564+28565)
28567	Interchangeable cell mattress
28568	Pump for 28567
28569	Kit cell mattress+pump (28567+28568)
28570	Spare cell for 28567

Manual and box in 10 languages: GB, FR, IT, ES, DE, PT, PL, HU, GR, Arabic

**TECHNICAL SPECIFICATIONS - PUMP**

	28565	28568
Size:	25x12xh 10 cm	
Operating voltage:	110-220 V, 50-60 Hz	
Working pressure:	40-100 mmHg	40-110 mmHg
Air output:	6-7 liter/min	6-7 liter/min
Cycle time:	6 min	12 min
Case:	TUV-CE IEC/EN60601-1; 60601-1-2	

**TECHNICAL SPECIFICATIONS - MATTRESS**

	28564	28567
Total size:	200x90x7 cm	200x86x9.5 cm
Cell height:	7 cm (2.7")	9.5 cm (4")
Material:	PVC	Nylon+PVC
Thickness:	0.32 mm	0.32 mm
Load:	135 kg	140 kg

# THERAPEUTIC ANTI-DECUBITUS MATTRESSES - STAGE III AND IV

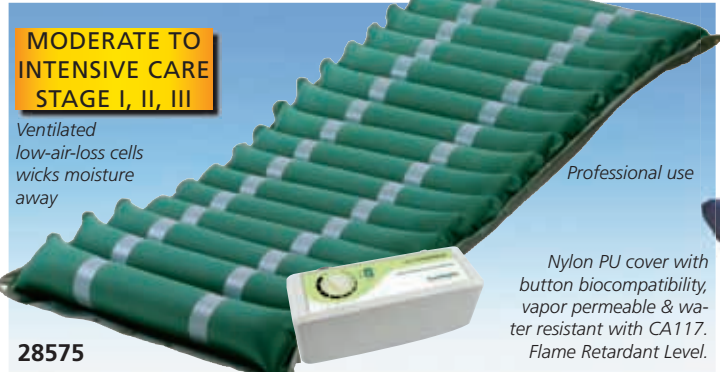

**MODERATE TO INTENSIVE CARE STAGE I, II, III**  
Ventilated low-air-loss cells wicks moisture away  
Professional use  
Nylon PU cover with button biocompatibility, vapor permeable & water resistant with CA117. Flame Retardant Level.  
**28575**

- **28575 KIT 5010E ALTERNATING PRESSURE MATTRESS + PUMP** Valuable overlay system designed for prevention and treatment of patients at moderate to intensive risk of pressure ulcers. Pressure is periodically redistributed by inflating and deflating cells in order to mimic natural sleep movement patterns and avoid long term pressurization of tissue. Manual in: GB, IT.
- **28576 CELL for 28575 - spare**

**INTENSIVE CARE STAGE I, II, III, IV**  
Cotton lining with zipper  
Professional use  
CPR straps quickly deflate the mattress for emergencies  
Low pressure alarm  
Air pressure dial adjustment  
**28580-2**

- **28580 KIT 8010 ALTERNATING PRESSURE MATTRESS + PUMP**
- **28582 KIT 8080 ALTERNATING PRESSURE MATTRESS + PUMP** Advanced systems of alternating pressure mattresses. The multi-mode pump offers:
  - **alternating mode:** the pressure is periodically redistributed by inflating and deflating cells in order to mimic natural sleep movement patterns and avoid long term pressurization of tissue.
  - **constant static mode:** the pressure is about 2/3 lowered when compared to the same pressure level from alternating mode by means of immersion and envelopment. Visual alarms notify the caregiver of unusual situation, reducing the risk of human error. Suitable for the prevention and treatment of all stages of pressure ulcers. Manual in: GB, IT.
- **28581 CELL for 28580 - spare** • **28583 CELL for 28582 - spare**

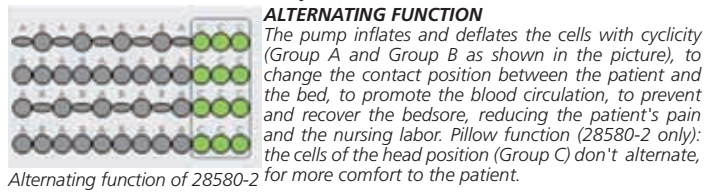

**TECHNICAL SPECIFICATIONS - PUMPS (28575, 28580, 28582)**

Size:	30x13.5xh 11 cm	Cycle time:	12 min
Operating voltage:	220-240 V, 50 Hz	Working pressure:	55-120 mmHg
Case material:	Flame retardant ABS	Air output:	7-8 liter/min
	TUV-CE IEC/EN60601-1; 60601-1-2		

**PUMP 28580, 28582 only**  
Quick connector with transfer cap to transform mattress into a sealed static surface to facilitate patient transportation.

Quick connector

**TECHNICAL SPECIFICATIONS - MATTRESS**

	28575	28580	28582
Total size:	198x86x12.8 cm	200x86x21 cm	
Alternating	1 in 2 (group A and B)		
Cell height:	12.8 cm (5")	20 cm (8")	
Cover material:	Nylon PU with button	Nylon+PU with cotton lining	
Thickness:	0.4 mm	0.4 mm	0,25 mm
Number of cells:	17+1 spare	20+1 spare	
Cells material:	nylon PVC	nylon PVC	nylon TPU
Load:	150 kg	160 kg	200 kg

# ANTI-DECUBITUS CUSHIONS

MADE IN FRANCE



28530



28534

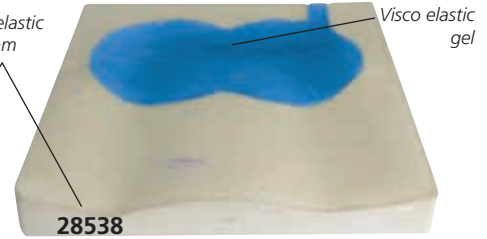

28538



PREVENTION FOR LOW TO MEDIUM DECUBITUS RISK



PREVENTION FOR HIGH DECUBITUS RISK



PREVENTION FOR HIGH TO VERY HIGH DECUBITUS RISK

GIMA line of seat cushions is designed to prevent decubitus risk for patients on wheelchair or permanently on chairs. All cushions in Gel or Foam are supplied with a waterproof PU cover with zipper and handle.

- 28530 BULGEL CUSHION 41x41x3 cm
- 28531 BULGEL CUSHION 43x43x3 cm

This anti-decubitus cushion is made of a flame-resistant pocket including a PE foam core covered by an aqueous gel.

- 28534 VISCO-MOUSS CUSHION 41x41x7\* cm
- 28535 VISCO-MOUSS CUSHION 43x43x7\* cm

Pre-shaped moulded cushion made of viscoelastic foam with memory effect. Memory foam is pressure sensitive and moulds quickly to body shape, returning to its original shape once the pressure is removed. Anatomical shape with raised lateral edges and front-back slope improves positioning, stability and comfort when seated. Foam density: 86 kg/m<sup>3</sup>  
\*Minimum 7 cm, maximum 8 cm

- 28538 GEL AIR 2D CUSHION 41x41x7.5 cm
- 28539 GEL AIR 2D CUSHION 43x43x7.5 cm

Moulded viscoelastic foam base (i.e. Visco Mouss) with a polyurethane gel insert. The viscoelastic fluid gel (blue pad) ensures maximum pressure relief of vulnerable bony areas while the regular gel and the foam increase the contact surface and maximize pressure relief. The cushion's shape ensures a good posture and prevents from sliding forward. Foam density: 86 kg/m<sup>3</sup>

# AIR CUSHIONS

- 28544 GIMA AIR CUSHION - 40x40x6 cm
  - 28546 GIMA AIR CUSHION - 45x45x6 cm
- with polyester cover, pump and repair kit
- single compartment
  - air cells, 64 or 81, prevent pressure sores
  - maximizes pressure distribution and blood flow
  - conforms to the body's shape
  - adjusts to body changes over time.

Max load: 150 kg

Multilingual manual: GB, FR, IT, ES, PT, GR, PL, DE, SE, RO.



Valve to adjust air and softness of cushion

Black rope for carrying the cushion

PREVENTION FOR HIGH TO VERY HIGH DECUBITUS RISK

# HEEL PROTECTOR

- 28548 HEEL PROTECTOR - 50x22x16 cm

It relieves the heel pressure and prevents decubitus ulcer by increasing the contact surface.

Anatomical shape visco elastic foam including a bactericide and fungicide agent for better hygiene and disinfection.

Density: 90 kg/m<sup>3</sup>



Made in France

# ANTI-DECUBITUS CUSHIONS AND NECK PILLOWS

MADE IN ITALY

Products to prevent low decubitus risk, made of silicone fibre, coated with 100% preshrunk cotton cover. Main property of

silicone fibre is to maintain original shape also after strong pressure. This allows to maintain comfort and proper weight

distribution in the time. Breathable cotton cover provides maximum cool comfort. Washable at 30-40°C.



28549

Size: 43x45 cm



28550

Size: 45x45 cm



Size: 45x45 cm



Size: 45x45 cm

- 28549 RING SHAPED CUSHION
- 28550 SHAPED CUSHION WITH HOLE

- 28551 3-SECTION CUSHION

- 28552 CUSHION WITH CONCAVE CENTRE

All cushions and pillow are supplied with multilingual instructions: GB, FR, IT, ES, PT, DE

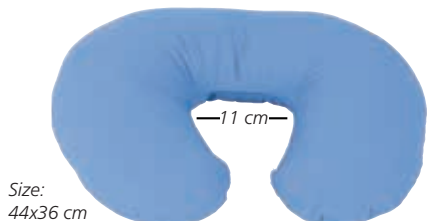

Size: 44x36 cm

- 28555 TRAVEL NECK PILLOW



Size: 32x12 cm

- 28556 HEEL CUSHION



Size: 32x15 cm

- 28557 HEEL CUSHION PLUS

## HYDRAULIC AND ELECTRICAL LIFTERS

Sling support  
min h 64 cm  
max h 158 cm



- **27749 HYDRAULIC LIFTER - max load 200 kg**  
Lifting movement through a hydraulic pump operated by adjustable side control lever. Descent movement by independent exhaust-valve. Adjustable base 68 to 118 cm controlled by a manual device for an easy access to narrow places. Painted steel frame. Anti trauma push-handle. 2 rear castors Ø 100 mm, with independent brake and 2 front castors Ø 70 mm. Equipped with sling with head support (27754).
- **27752 ELECTRICAL LIFTER 170 - max load 170 kg**
- **27753 ELECTRICAL LIFTER 200 - max load 200 kg**  
Same as code 27749 but with electrical controls. Up and down movements through an electric motor 24V D.C. and push button. Battery fed with current transformer with an emergency push-button for the immediate stop of the movement and free up/down piston-stroke. Supplied with universal sling (27752) or sling with head support (27753).

- **27767 UNIVERSAL SLING - spare - load 250 kg**
- **27754 SLING with head support size M - spare - load 250 kg**  
Mesh fabric sling.

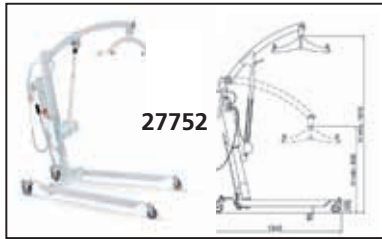

## LIFTING STAND

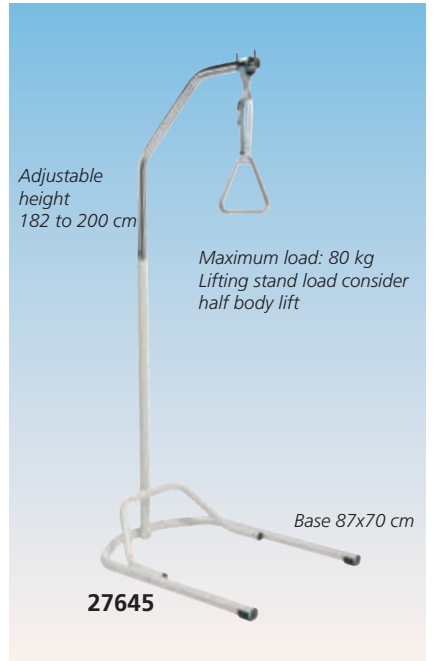

- **27645 LIFTING STAND**  
Tubular painted steel frame with adjustable chromed steel joint. Can be fully disassembled to reduce size. Three main height adjustments. Triangle hangs from belt with adjustable length.

## HYDRAULIC PATIENT LIFTER



- **43450 HYDRAULIC PATIENT LIFTER - max load 150 kg**  
Hydraulic lifter made of steel frame, surface with coating. Front Ø 7.5 cm wheels without brake, rear Ø 10 cm wheels with brake. The legs can be opened by pedal. Height adjustment by hydraulic pressure or manual control. Supplied with sling.

### TECHNICAL SPECIFICATIONS

Arm length:	990 mm
Leg length:	1190 mm
Overall width:	590 mm
Base open width:	860 mm
Hook height:	950-1650 mm
Push handle height:	1140 mm
Base clearance:	115 mm
Load:	150 kg

## LIFT POLE

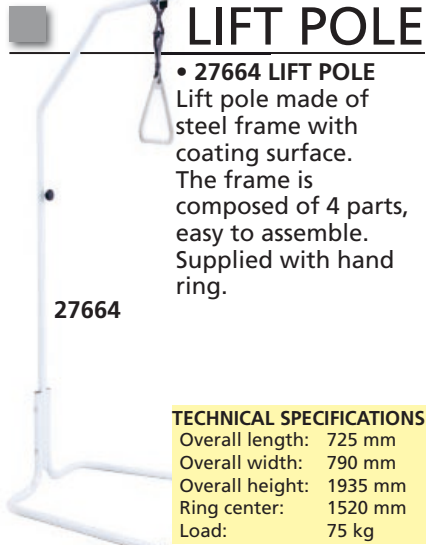

- **27664 LIFT POLE**  
Lift pole made of steel frame with coating surface. The frame is composed of 4 parts, easy to assemble. Supplied with hand ring.

### TECHNICAL SPECIFICATIONS

Overall length:	725 mm
Overall width:	790 mm
Overall height:	1935 mm
Ring center:	1520 mm
Load:	75 kg

## ELECTRIC ALUMINIUM PATIENT LIFTER



- **43460 ELECTRIC ALUMINIUM PATIENT LIFTER - FOLDABLE**  
Electric lifter with aluminum frame and coating surface. Foldable for easy storage and transfer. 7.5 cm Ø wheels: front wheels without brake, rear wheels with brake. The legs can be opened by pedal. One function hand controller. Provided with emergency stop button, emergency drop device and backup battery. Supplied with sling.

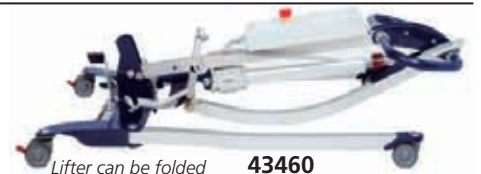

### TECHNICAL SPECIFICATIONS

Overall length:	1180 mm
Overall width:	710 mm
Foldable size:	1310x710xh 335 mm
Base open width:	1070 mm
Boom height:	0-1610 mm
Push handle height:	1160 mm
Base clearance:	100 mm
Base length:	1120 mm
Base inner width:	600-960 mm
Power supply:	220 V - 50 Hz
Load:	150 kg

# LIFT ARMCHAIRS WITH 1 OR 2 MOTORS

Lift armchairs that feature a powered lifting mechanism that pushes the chair up from its base to assist the user to a standing position. Power supply: 100-240 V - 50/60 Hz. Multilingual manual: GB, FR, IT, ES.



**1 motor lift armchair:**  
the chair's backrest and footrest can lift or recline together.

**ARIANNA LIFT ARMCHAIRS 1 or 2 MOTORS**



45176

**2 motors lift armchair with extra lifting footrest:**  
it can reach the bed position providing a relaxing experience. Its backrest and footrest can operate separately to any position. Extra lifting footrest allows 8 cm lifting adjustment higher than flat position.

ARIANNA LIFT ARMCHAIRS with 1 or 2 motors						
Blue	Brown	Green	Burgundy	Motors	Fireproof	Footrest
45170	-	-	45173	1 motor	no	standard
45175	45176	45177	45178	2 motors	no	extra
45179	-	-	-	2 motors	yes	extra
COVERS FOR LIFT ARMCHAIRS						
45195	45196	45197	45198	Covers for armchairs		
Seat			Backrest	Chair		Load
Width cm	Depth cm	Height cm	Height cm	Width cm	Length cm (reclined)	kg lbs
49	49.5	49	70	75	170.5	150 331



45175, 45179

45178

**GINEVRA LIFT ARMCHAIRS 2 MOTORS**



45180

GINEVRA LIFT ARMCHAIRS with 2 motors						
Blue	Brown	Green	Burgundy	Motors	Fireproof	Footrest
45180	-	45182	45183	2 motors	no	extra
-	45184	-	-	2 motors	yes	extra
COVERS FOR LIFT ARMCHAIRS						
45195	45196	45197	45198	Covers for armchairs		
Seat			Backrest	Chair		Load
Width cm	Depth cm	Height cm	Height cm	Width cm	Length cm (reclined)	kg lbs
46	51	40	66	74	169	150 331



45183

45182

**FLAVIA LIFT ARMCHAIRS 2 MOTORS**



45188, 45190

FLAVIA LIFT ARMCHAIRS with 2 motors						
Blue	Brown	Burgundy	Motors	Fireproof	Footrest	
45185	45186	45188	2 motors	no	extra	
-	-	45190	2 motors	yes	extra	
COVERS FOR LIFT ARMCHAIRS						
45195	45196	45198	Covers for armchairs			
Seat			Backrest	Chair		Load
Width cm	Depth cm	Height cm	Height cm	Width cm	Length cm (reclined)	kg lbs
47	50	47	74	78	171.5	150 331



45185

45186

## BED-TRAY - FOLDING LEGS

• **44751 BED TRAY - white**  
 Plastic moulded bed-tray with containing edge.  
 Chrome plated steel tube folding legs.  
 Size: 58x39xh5 cm.  
 Pack size: 65x45xh 8 cm.  
 Weight: 1.9 kg



**44751**  
 MADE IN ITALY

## DINING TABLE

• **27449 DINING TABLE**  
 Patient dining table with polished aluminium tubular structure. White laminated wooden top, with anti-shock rubber PVC band.  
 Two rubber feet and two plastic wheels Ø 50 mm for easy mobility and comfortable use. Delivered in kit form.

Size: 110x42x93 cm

**27449**

MADE IN ITALY



## OVERBED TABLES



Tray dimensions:  
58x39xh 5 cm

MADE IN ITALY

Adjustable height:  
75 to 114 cm

Base: 70 x 44 cm **27469**



Tabletop 60x40 cm

Adjustable height  
61 to 94 cm

**27475**

4 castors,  
2 with brake

MADE IN FRANCE

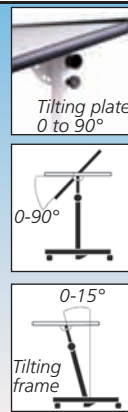

Tilting plate  
0 to 90°

0-90°

0-15°  
Tilting frame



Adjustable height:  
72 to 110 cm

Multilingual instructions:  
GB, FR, IT, ES, PT,  
DE, RO, SI.

**27448**



Set into the panel

Lock and adjustable panel

Adjustable height

• **27469 OVERBED TABLE - moulded tray**  
 Frame made of chrome plated steel tube. Serving tray made of thermoformed anti-shock plastic material with retaining edges and pre-formed bottle, glass and cutlery holder. Base with 4 Ø 50 mm castors. Carton size: 59x22x63 cm. Delivered in kit form.

• **27475 OVERBED DIFFUSION TABLE - white**  
 Overbed table with high quality, laminated, fire resistant tabletop with an edging strip. Epoxy coated "C" shaped steel frame allows for closer access while sitting on a chair. Delivered ready to use and easy to fold flat (15 cm) for ease of storage. Weight: 8 kg. Max load: 10kg.

• **27448 OVERBED TABLE**  
 Overbed table with steel frame and high density board. Base with 4 Ø 50 mm (2.5") removable castors (2 with brake). Adjustable height and angle. Board size: 41x61 cm. Carton size: 65x7x67 cm. Delivered in kit form.

## MASTER OVERBED TABLE



Height adjustment  
(765-1050 mm)

Extra large ABS table top with cup socket

Air spring for height adjustment

**27447**

• **27447 MASTER OVERBED TABLE**  
 High quality overbed table with adjustable height by gas spring system. Easy to clean table top made of ABS material, equipped with cup holder and high edges to protect objects from falling down. Anti-collision and durable round corner design. Bottom frame is sprayed with carbon steel. 4 revolving rubber castors Ø 50 mm, 2 with brake.  
 Size: 890x440xh 765-1050 mm.

## OLYMPUS BEDSIDE TABLES



**43550**

**43551**

**43552**

MADE IN ITALY

- **43550 OLYMPUS BEDSIDE TABLE**
- **43551 OLYMPUS BEDSIDE TABLE with OVERBED TABLE**
- **43552 OLYMPUS BEDSIDE TABLE with TILTING OVERBED TABLE**

Double-sided bedside tables made of polyethylene. The inner compartment has a removable plastic shelf and a removable grid at the bottom to guarantee ventilation. Side panels include plastic towel holder, two cup and two bottle holders all equipped with retaining clamps. Drawer and doors made of moulded polyethylene plastic material with integrated handles. Height adjustable overbed tables (43551, 43552) with epoxy powder-coated steel frame with raised edges to avoid spills. 360° rotation and horizontal maneuverability of plate. Tilting top at different angles (43552 only). Four 55 mm Ø twin swivel castors.

### TECHNICAL SPECIFICATIONS

Size: 61.5x48.5xh 75 cm (43550) 61.5x48.5xh 91 cm (43551-2) Overbed table (only 43551-2): size: 57x44 cm  
 Weight: 14.5 kg (43550), 21.5 kg (43551-2) height: from 91 to 121 cm  
 Drawer compartments size: small: 36x10xh 8.5 cm horizontal extension: 15 cm  
 large: 36x18xh 8.5 cm  
 Interior compartment size: 32.5x38xh 44 cm



## ROOM FURNITURE

- 43525 ROOM WARDROBE - streaked beige
- 43526 ROOM WARDROBE - blue/ivory
- 43530 ROOM TABLE - ivory

### Room wardrobes

Structure made of melamine, available in two colours: streaked beige or blue/ivory. Internal central partition that forms two compartments: one compartment with 4 adjustable shelves and drawer, other compartment has an upper shelf with rod for clothes and bottom shelf to store shoes. Provided with cylinder lock, 4 visible feet (height: 15 cm) with levellers.

Size: 90x54xh 185 cm.

Delivered disassembled.

### Room table

Top in ivory wood agglomerate with perimeter edge in ABS. 4 legs in aluminium painted steel with levellers.

Artemide Bedside tables See at bottom.



27655

MADE IN ITALY

Size: 90x50xh 75 cm

43530

43526

43525

## MULTIFUNCTION DOUBLE BASE UNITS

### DOUBLE BASE UNITS

High quality double base units made of wood covered with scratch-resistant and anti-reflective melamine finish. The top, bottom and back of the structure and the shelves are covered with ABS edges. 4 legs (height: 15 cm) with levellers. Two models: one with 4 drawers and door with 2 shelves (41.4 cm) and the other one with 2 doors and 2 shelves (86.4 cm). It can be requested in different colours.

### Optional changing mat for baby

Soft and comfortable changing mat can be applied on upper panel of double base unit. Made of a particle panel with foam padding covered with faux leather, fire retardant. Class 1 IM.

GIMA code	DOUBLE BASE UNITS - 90x60xh 85 cm							
43510	4 drawers + door with 2 shelves - white							
43514	4 drawers + door with 2 shelves - any colour*							
43515	2 doors with 2 shelves - white							
43519	2 doors with 2 shelves - any colour*							
Available Colours:	412	431	441	482	484	499	861	1818
*You have to indicate requested colour with order. Available in 30 days								
CHANGING MATTRESS - 92x62 cm								
43520	Changing mat for baby - white - optional							



43519

MADE IN ITALY

43520

43510+ 43520

## BEDSIDE TABLES



Towel hook

27648

Shoe holder integrated

27651

27654

MADE IN ITALY

27655

Size: 45x40xh 75 cm

27674

MADE IN ITALY

27662

Size: 42x40xh 80 cm

Size: 42x52.5xh 80 cm

### MEDEA BEDSIDE TABLES

Bedside tables made of 100% pure ABS plastic injection. Non-toxic, strong, anti-rust and anticorrosion.

Easy to clean and long life time using. ABS top designed to avoid stuff falling.

Provided with easy to clean and anti-rust towel hook on one side, one retractable shelf, one drawer and a door with two internal shelves for big storage space.

Size: 48x48x76 cm (27651).

Size: 48x48x87 cm (27648).

- 27651 MEDEA BEDSIDE TABLE
- 27648 MEDEA BEDSIDE TABLE with shoe holder

### ARTEMIDE BEDSIDE TABLES

Structure, drawer and door in wood agglomerate covered with melamine material with scratch-resistant and anti-reflective finish.

Coated with embossed ABS edges.

The door is secured to the structure by sturdy metal hinges with anti-corrosion treatment. Handle in satin steel, 4 wheels Ø 55mm (two with brake), adjustable and removable inner shelf.

Class E1- a, EN 120/92.

- 27654 ARTEMIDE BEDSIDE TABLE - streaked beige
- 27655 ARTEMIDE BEDSIDE TABLE - blue

### FEBO BEDSIDE TABLES

Epoxy powder coated steel sheet 8/10 body. Towel holder and lateral bottle holder (27662 only). Soft rubber antitrauma handle. Sliding drawer with removable ABS tray. Inner removable shelf. 4 revolving castors (2 with brake)

- 27674 FEBO BEDSIDE TABLE - blue avio RAL 5014

- 27675 FEBO BEDSIDE TABLE - other colours\*

RAL	RAL	RAL	RAL	RAL
5010	2003	6019	1013	7040

\*Available in 30 days. Minimum order 10 pcs.

- 27662 FEBO BEDSIDE TABLE WITH BOTTLE HOLDER - blue avio RAL 5014

## NEONATAL CRADLE

• **43500 NEONATAL CRADLE with trolley**

Transparent unbreakable plastic cradle with round edges and ventilation holes. Epoxy powder painted mainframe made of curved and welded tubular steel. Trolley shape allows horizontal and Trendelenburg inclinations and bedside positioning. 4 synthetic rubber castors Ø 75 mm, two with brake. Weight: 15 kg. Max load: 10 kg. Manual: GB, FR, IT, ES. Delivered disassembled.



43500

Dimensions:  
83.5x52.5xh 90 cm

• **43501 CRADLE - spare**

• **27685 MATTRESS 63x37x5.5 cm - fireproof**

With removable fire retardant cover.

• **27686 COVER - water proof**



27400

MADE IN ITALY

## BABY CRADLES

• **43502 BABY CRADLE - light blue**

• **43503 BABY CRADLE - pink**

Cradles with stylish and ergonomic design to provide a comfortable experience for babies. Transparent baby basin made of plastic. Wear-resistant, antiskid, shock absorption double side castors Ø 76 mm (3") can freely rotate 360°. Easy to operate handle to control gas spring. 12° reverse Trendelenburg. Adjustable height by hydraulic pump. Size: 875x525xh 650 to 900 mm. Packing size: 930x560x850 mm. Supplied with baby basin.



43502

• **43504 MATTRESS**



Mattress with flannel cover and foam inside



Adjustable height



+12° Reverse Trendelenburg

## SWADDLING TABLE

• **27400 SWADDLING TABLE - beige**

Baby changing table with Itallumag tubular frame with 2 shelves. Padded worktop 115x60 cm in soft washable fireproof (Class 1 IM) simulated leather and lower shelf 100x40 cm, in laminated chipboard panel.

Max load: 50 kg  
Size: 115x63xh 85 cm  
Weight: 28 kg  
Delivered disassembled.

MADE IN ITALY

## PEDIATRIC BED

• **27399 PAEDIATRIC BED 1-4 years - ivory**

Epoxy powder painted mainframe made of steel tube Ø 30 mm, ready to be hooked into the mattress platform. Mesh mattress platform made of oval tube 40x20 mm, fixed to the mainframe with removable bolts. Side rails 62 cm h. sliding on chromed steel guides, with safety device. Legs with 4 castors Ø 80 mm, two with brake. Weight 35 kg. External measurement 140x70xh 130 cm Inner size 130x65xh 63 cm.

• **27687 MATTRESS 125x62x10 cm - fireproof**

• **27688 COVER - water proof**



27399

MADE IN ITALY

## CHILDREN BEDS - 2 CRANKS

• **43506 CHILDREN BED - 2 cranks - light blue**

• **43507 CHILDREN BED - 2 cranks - pink**

Beds for children with frame made of sheet metal bending and welding. Plastic parts made of ABS material and epoxy painting. Bed ends are made of PP blow moulding to protect bed and patient.

• **43508 MATTRESS - 1770x720x100 mm**

Mattress made of polyurethane foam, density 30 Kg/m<sup>3</sup>. Radiotransparent, antimicrobial, latex and CFC free. Odourless and fire retardant. Supplied with 100% polyester liner, washable.

**Guardrail**

Aluminium alloy liftable guardrail with 8 cm distance among protective tubes. 3 gears to adjust height, anti-pinch hands to protect children.

43507

Hand control  
Manual cranks to control back and leg liftings

Shoes' holder  
Utility and shoes holder

IV Pole  
Stainless steel IV pole, bearing 15 kg

Castors Ø 12.7 cm (5") castors with brakes

Platform  
Concave vent hole design of the panel allows strong air permeability and can effectively prevent bedsores.

**TECHNICAL SPECIFICATIONS**

Size:	1880x900xh 1260 mm
Bed height:	585 mm
Mattress platform:	1770x720 mm
Back-rest adjustment:	0-75° (± 10°)
Knee-rest adjustment:	0-35° (± 10°)

**STANDARD ACCESSORIES**

1 set full length side rail	4 buffer air springs
1 stainless steel IV pole bearing 15 kg	Shoe holder
4 IV pole provision (2 on each head)	
2 drainage hooks	

# MATTRESSES, COVERS AND PILLOWS

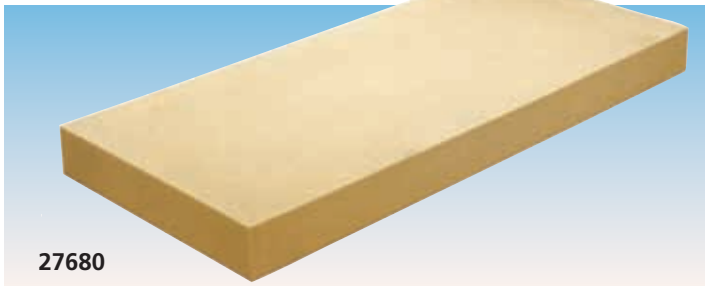

27680

- 27690 MATTRESS 190x80x12 cm
  - 27680 MATTRESS 195x85x14 cm
- Polyurethane foam mattresses, density 30 kg/mc
- 27691 POLYESTER COVER 190x80x12 cm - white
  - 27681 POLYESTER COVER 195x85x14 cm - white

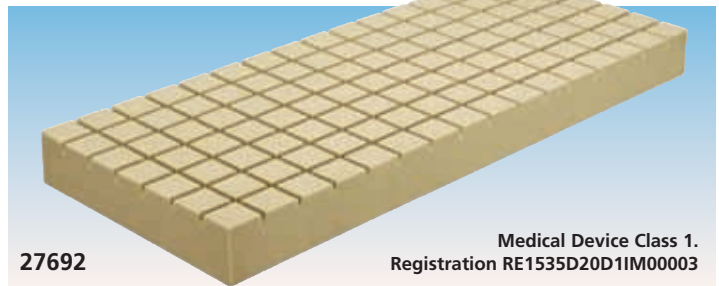

27692

Medical Device Class 1.  
Registration RE1535D20D11M00003

- 27692 DAMA MATTRESS 195x85x14 cm
- Expanded polyurethane mattress, density 30 kg/mc.  
Fire proof and latex free.  
Antibacterial, hypoallergenic and antifungal.  
Autoclavable at 135 °C.

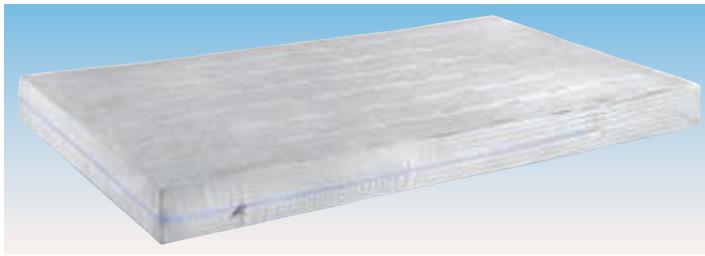

- 27682 MATTRESS WITH COVER 195x85x14 cm
- Polyurethane foam mattress, density 30 kg/mc with flame retardant, 100% breathable polyester cover. Class 1



Medical Device Class 11M.  
Registration RE1535D20D11M00008

- 44804 HNF MATTRESS WITH COVER 195x85x14 cm
- Polyurethane foam mattress, density 35 kg/mc. Non deformable, antibacterial, antifungal and autoclavable at 135°C.  
Supplied with TEKMA polyurethane cover with zip fastener.

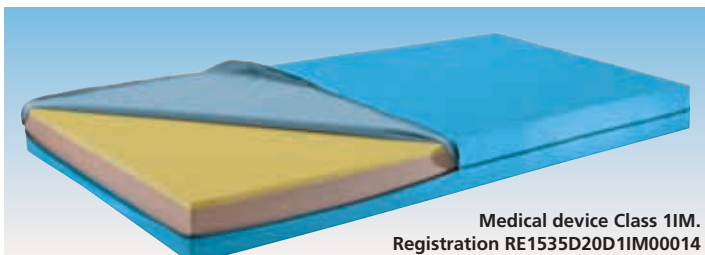

Medical device Class 11M.  
Registration RE1535D20D11M00014

- 44806 AMYLIFE MATTRESS WITH COVER 195x85x14 cm
- Mattress with polyurethane foam base and viscoelastic high density top. Density 35 kg/mc (base), 60 kg/mc (top). Non deformable, antibacterial, antifungal and autoclavable.  
Supplied with TEKMA polyurethane cover with zip fastener.

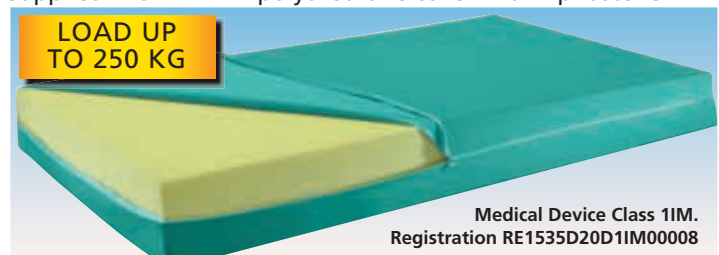

Medical Device Class 11M.  
Registration RE1535D20D11M00008

- 44803 MATTRESS WITH COVER 195x85x18 cm
- Polyurethane foam mattress, density 35 kg/mc. Non deformable, antibacterial, antifungal and autoclavable at 135°C.  
Supplied with TEKMA polyurethane cover with zip fastener.



Class 11M.  
Registration RE1535D20D11M00001

- 27696 PILLOW 45x75x10 cm
- Polyurethane foam, transpirant, pillow, density 21 kg/mc with polyester, fire retardant, cover. Washable at 95°C, autoclavable.



Class 11M.  
Registration VA735D11M00014

- 44812 SWEET DREAM PILLOW 50x80x18 cm
- Polyester padding and polyester cover washable at 40°C. Fire retardant.



Class 1

- 27681 POLYESTER COVER 195x85x14 cm - white
- Transpirant polyester fireproof cover for mattresses (27680, 27682, 27692)



Class 1

- 27695 TEKMA POLYURETHANE COVER - 195x85x18 cm - white
- Soft, fire retardant, transpirant and waterproof cover. Universal (up to h14 cm) with elastic. Washable. Autoclavable at 134°C.

## BACKREST



- 44825 BACKREST - blue
- Painted steel tubular frame. Adjustable in 5 positions .

## COVER LIFTER

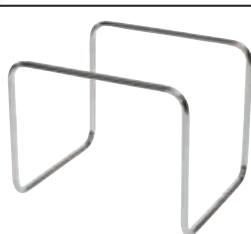

- 27642 COVER LIFTER
- Chromed steel tubular frame. Can be disassembled.

## A4 AND A3 RECORD HOLDERS

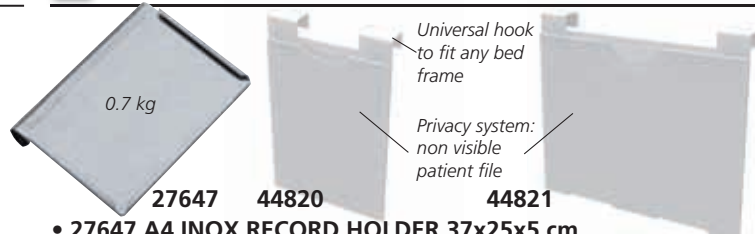

- 27647 A4 INOX RECORD HOLDER 37x25x5 cm
- 44820 A4 PVC WHITE RECORD HOLDER 24x32 cm
- 44821 A3 PVC WHITE RECORD HOLDER 43x32 cm

Universal hook to fit any bed frame

Privacy system: non visible patient file

# HOSPITAL BEDS



27601

27841

**BED WITH ADJUSTABLE HEAD SECTION**

- 27600 BED WITH 1 ARTICULATION
  - 27601 BED WITH 1 ARTICULATION with castors
- Painted steel frame with net.  
Pipe frame with net for head movement.  
2 heads in chromed pipe complete with MDF bilaminated coated panel. Movement by a crank. Protection of end run. Rubber castors Ø 100 mm, with brakes (only for code 27601)  
Size: 206x89xh 90 cm. Height of frame from bottom 52/55 cm. Size of frame: 200x85 cm. Weight 32 kg. Load 110 kg.



27608

- 27607 STANDARD PLUS BED
  - 27608 STANDARD PLUS BED with Ø 100 mm castors
- Chrome-plated steel bed ends.  
Laminated plastic panels. Rigid mesh mattress platform.  
Adjustable back-rest. Size: 206x89xh 90 cm. Load 110 kg.

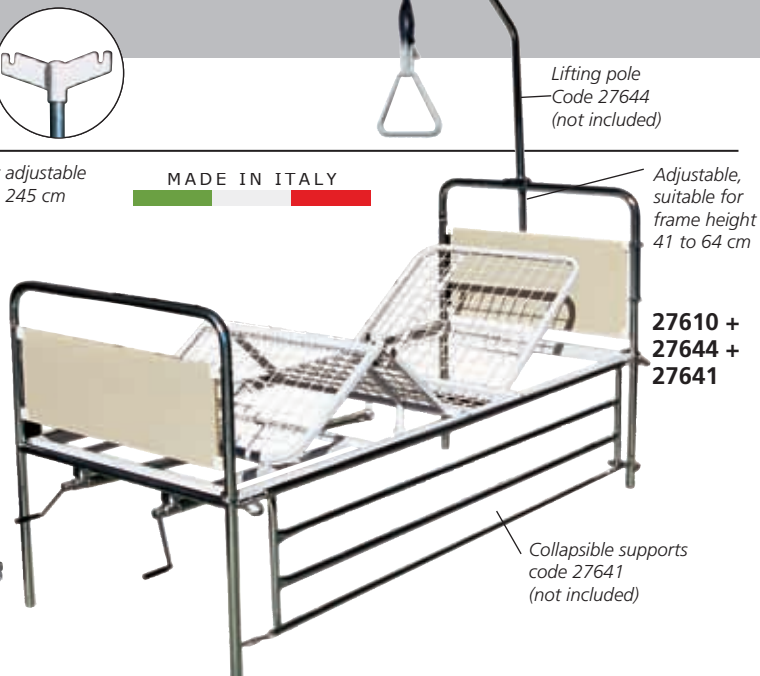

27610 +  
27644 +  
27641

**BED WITH ADJUSTABLE HEAD AND FOOT SECTION**

- 27610 BED WITH 3 ARTICULATIONS
  - 27611 BED WITH 3 ARTICULATIONS with castors
- Painted steel frame with 3 section net.  
Painted steel pipe, 200x85 cm.  
2 heads in chromed pipe complete with MDF bilaminated coated panel. Movement by 2 cranks. Protection of end run. Rubber wheels Ø 100 mm, two with brake (only 27611)  
Size 206x89xh 90 cm. Height of frame from bottom 52/55 cm. Size of frame: 200x85 cm. Load 110 kg. Weight 42 kg.



27605

- 27605 STANDARD BED
  - 27606 STANDARD BED with Ø 50 mm castors
- Basic bed made of epoxy - coated steel.  
Head and foot ends with plastic feet (27605) or castors (27606).  
Rigid mesh mattress platform. Load 110 kg.

# ACCESSORIES FOR BEDS

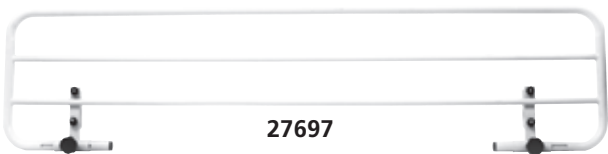

27697

- 27697 N-SHAPED BEDRAIL 165x40 cm
- Bedrail made of steel frame and surface with coating. Siderail can be fixed by screw. Max load: 75 kg.



27698

- 27698 DELUXE ADJUSTABLE BEDRAIL 194-220x43.5 cm
- Bedrail made of steel frame and surface with coating. Adjustable siderail length by spring. Max load: 75 kg.

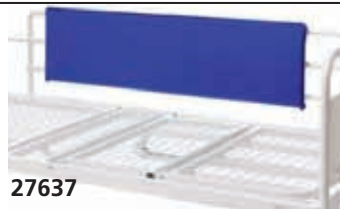

27637

- Bed side pad*  
Protection for patients against accidental collisions on rigid sides of the bed.  
Made of polyurethane foam with not removable outer coating water-repellent and flame retardant.  
Size: 166x50xh 3 cm



27649

- Raising block*  
Designed to raise bed or chair by 9 cm (inner) Ø 8.7 cm, base Ø 16.6 cm)



27646

- IV stand*  
Stainless steel IV stand with 4 hooks

GIMA code	ACCESSORIES FOR ALL BEDS
27641	Universal collapsible supports - pair - see above
27644	Lifting pole - see above
27646	4 Hook IV stand for bed - stainless steel
27637	Bed side pad with velcro
27649	Raising blocks 9 cm - kit of 4
27841	I.V. Stand - 5 wheels trolley, see page 140

# MANUAL PATIENT BEDS WITH 3 OR 4 JOINTS

**Guardrail**  
Aluminium alloy side rail, 6 staff, collapsed type with safe lock



**44740**

**Mattress retainer**  
Platform integrated mattress retainer on both sides (back and leg section), with a boarder of 33 mm high

**Castors**  
4 Ø 12.7 cm castors

**Hand control**  
Crank to control lifting

**IV Pole**  
Stainless steel IV pole, bearing 15 kg



**44742**

**Wall bumper wheel**  
Equipped with 4 bumpers to protect the bed and wall

- 44740 3 JOINTS PATIENT BED - 2 cranks - castors
- 44742 4 JOINTS PATIENT BED - 3 cranks - variable height - castors

Manual patient beds with 3 or 4 joints adjustable by means of 2 or 3 cranks. PP head and foot board equipped with bumpers wheel Ø 65 mm, preventing collision. PP bed platform, divided in 4 or 5 sections with integrated mattress retainer. Plastic parts and epoxy painting.

### TECHNICAL SPECIFICATIONS

Size:	2130x995 mm
Height:	500 mm (44740), adjustable 420-730 mm (44742)
Mattress platform:	1925x900 mm
Max. patient load:	200 kg
Movement:	2 cranks (44740), 3 cranks (44742)
Back-rest adjustment:	0-70° (± 5°)
Knee-rest adjustment:	0-38° (± 5°)

### STANDARD ACCESSORIES

- 2 foldable side rails
- IV pole 4 hooks
- 4 IV pole provisions
- 2 drainage hooks

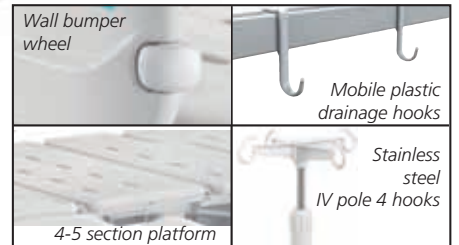

**44742 Height adjustment**

# ELECTRIC PATIENT BEDS

**Mattress retainer**  
Platform integrated mattress retainer on both sides (back and leg section) with a boarder of 33 mm high

**Guardrail**  
Aluminium alloy foldable side rail, 6 staff, collapsed type with safe lock

**IV Pole**  
Stainless steel IV stand, bearing 15 kg

**Angle indicator**  
Integrated angle indicator to clearly show back-rest and Trendelenburg position

**Guardrail**  
Tuck away side rail with integrated buffer. Handle allows patient to get up and off the bed easily

**Hand controller**  
Controller with flexible spiral cable for easy operation. Nurse can control all standard functions

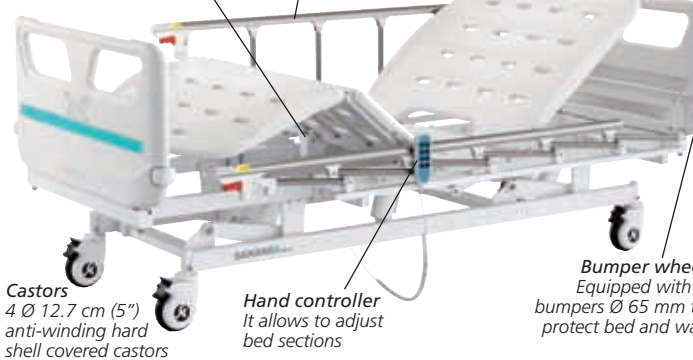

**Castors**  
4 Ø 12.7 cm (5") anti-winding hard shell covered castors

**Hand controller**  
It allows to adjust bed sections

**Bumper wheel**  
Equipped with 4 bumpers Ø 65 mm to protect bed and wall

- 44744 ELECTRIC PATIENT BED - adjustable height
  - 44746 ELECTRIC PATIENT BED with TR and RTR - adjustable height
- Electric patient beds with integrated PP bed platform and electric motor to facilitate different movements of bed sections. Hand controller allows nurses to control standard functions. Both models have an American motor with UL/ROHS/EN standard. Plastic parts and epoxy painting. PP head and foot board equipped with four bumpers wheels Ø 65 mm. It is provided with auto-regression 10+9 cm (44746 only) to minimize the pressure and shear forces in patients' pelvic area and to reduce development of pressure ulcers.

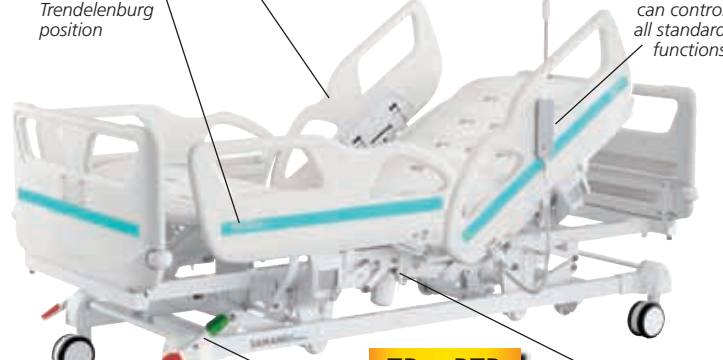

**Castors**  
4 Ø 12.7 cm (5") double side castors with central locking. Anti-winding hard shell cover

**Brake system**  
Brake spring retains quality even after 10.000 uses

**Drainage hooks**  
Plastic drainage hooks integrated inside the siderails

**TR + RTR**

### TECHNICAL SPECIFICATIONS

	<b>44744</b>	<b>44746</b>
Size:	208.5x99.5 cm	208.5x102.5 cm
Height adjustment:	from 42 to 73 cm	from 45.5 to 74.5 cm
Mattress platform:	192.5x90 cm	
Safe working load:	200 kg	250 kg
Back-rest adjustment:	0-75° (± 5°)	
Knee-rest adjustment:	0-46° (± 5°)	0-32° (± 5°)
Trendelenburg:	-	0-12°
Reverse Trendelenburg:	-	0-12°
Angle indicator:	-	0-90°
Auto-regression:	-	10+9 cm
Position line:	-	30°
Motor: life:	20.000 movements	
Motor: noise:	under 50 dB	
Voltage:	100-240 V - 50/60 Hz	

- ### STANDARD ACCESSORIES
- 1 hand controller
  - 1 set foldable side rails (44744 only)
  - 1 set PP side rails extra height (44746 only)
  - 1 IV stand with 4 hooks
  - 4 IV pole provisions
  - 2 drainage hooks
  - 4 angle indicators (44746 only)



# HEIGHT ADJUST. ELECTRIC BED WITH TR AND RTR



Bed weight  
140 kg

Size:  
110x225xh 91 cm

**44799**

- **44799 HEIGHT ADJUSTABLE ELECTRIC BED - compass rail**
- **44800 HEIGHT ADJUSTABLE ELECTRIC BED**

3 joint, 4 section Hospital bed, with electronic adjustment of height and platform, Trendelenburg and Reverse Trendelenburg positions (15°).

All steel components are epoxy-coated.

Back section regulation using electric actuators with anti-crushing and rototranslation function to avoid abdominal crushing. Both bed sides have CPR manual levers for emergency manoeuvres.

Foot rest adjustment by click mechanisms allowing 6 positions.

Remote control to maintain position or disable.

The keypad allows adjustment of backrest, bed surface height, legs and foot rest, comfort position, TR and RTR

Bed weight  
130 kg

Size:  
110x225xh 91 cm

**44800**

- **44801 LIFTING POLE**
- **44802 IV POLE**
- **44803 FLAME RETARDANT MATTRESS with waterproof cover**  
Load 280 kg. Density 35 kg/m<sup>2</sup>. Size 85x195x18 cm.

### TECHNICAL SPECIFICATIONS

Minimum/maximum height surface: 380-780 mm  
 Maximum backrest regulation: 71°  
 Maximum leg/foot height regulation: 30°  
 Trendelenburg/reverse trendelenburg: 15°  
 Minimum/maximum height: 835-1245 mm  
 Maximum total width/length: 1010/2260 mm (bumpers and siderails included)  
 Worksurface width/length dimension 880/2000 mm  
 Power supply: 160-230 V - 50-60 Hz  
 SWL: 270 kg IEC protection class: I / B IP code (protection rating): IP66

## SHOWER MATTRESS

- **27836 SHOWER MATTRESS**

It allows bed-ridden, elderly or disabled patients to be washed directly on their bed, without any need for transfer/lift.

The patient can be showered with water coming from the tap via an extension hose or using the special pressurized water tank provided with flexible hose and shower head. Once finished, the water is drained into a suitable container. Complete with plug and flexible hose 6.4 m for quick water drain.

- **27837 WATER TANK - 10 l**

Pressurized water tank complete with flexible hose 4 m and shower head operated by button.

- **27838 SHOWER EXTENSION HOSE - 6 m**

Flexible, hose with button-operated shower head and tap adapter.



## SHOWER TROLLEY - HYDRAULIC OR ELECTRIC HEIGHT ADJUSTMENT

- **44770 SHOWER TROLLEY - hydraulic**

Shower stretcher can be used for both transport and showering. Ideal solution for treatment of patients in assisted baths of hospital or retirement home. Rubber castors Ø 12.5 cm with individual brake and one with directional lock to facilitate transport in long linear path. Automatic progressive tilting to allow a gradual water drainage. Safety side rails with one-hand folding/locking system. Supplied with PCM foam padded waterproof mattress and pillow made of fire-resistant auto-extinguishing Class 2 PVC, extendable and flexible drain hose (Ø 40 mm - length 1.5 m).

- **44771 SHOWER TROLLEY - electric**

Same as 44770 but with electric lifting system (Linak actuator, 6,000N, DC 24 V, 4.5 A). IP x 5 control box with emergency stop.

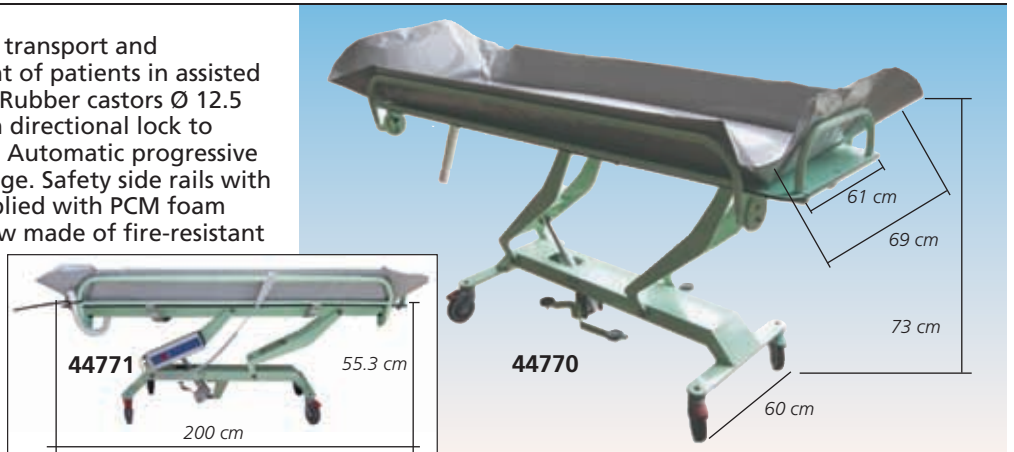

### TECHNICAL SPECIFICATIONS

Max working load:	190 kg	Size:	2,000 x 746 x h 753/1,108 mm	Tilt for water discharge:	7°	Collapsible head end rail:	yes
Weight:	93 kg	Mattress height:	20 cm	Discharge hose length:	150 cm	Directional system:	yes

## SPECIALISTIC BED 3 JOINTS/4 SECTIONS, ELECTRICAL, ADJUST. HEIGHT



**QUALITY**  
EN 1970:2000  
DIN EN 1970:2000-12  
EN 60601-2-38:2001  
DIN EN 60601-2-52:2009

- **27673 SPECIALISTIC BED with Trendelenburg - 40-80 cm**
- **27672 SPECIALISTIC LOW BED with Trendelenburg - 23-63 cm**

Three-joints, four sections bed with adjustable height from 40 to 80 cm or 23-63 cm with full electrical movements. All welded mainframe made of rectangular steel tube 50x25x2 mm. Mattress platform with flexible wooden staves, complete with mattress-hold guides. Backrest-section and leg-section adjustable by means of two independent electric motors 24V D.C. and push-button. Foot-section adjustable by means of a rack device. Fixed pelvis-section. Removable head and foot-end frames made of natural beech finish wood with solid corners and edges. Comes complete with 2 vertical sliding bars with upper/lower lock/unlock keys and lifting pole. Legs fitted with 4 castors Ø 100 mm with independent brake.

### TECHNICAL SPECIFICATIONS

Size of platform: 900x2,000 mm  
Platform height: 400-800 mm (27673)  
230-630 mm (27672)  
External measurement: 1,030x2,140 mm  
Height of bed end from mattress platform: 50 mm  
Max load: 135 kg  
Weight: 102 kg  
Operating power: 230 V - 50 Hz

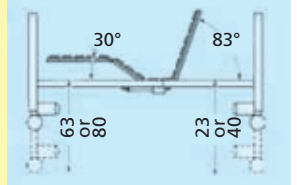

- **27676 WOODEN BEDSIDE TABLE - height adjustable, tiltable tray**
- **27677 WOODEN BEDSIDE TABLE - extractable tray**

Manufactured by quality laminated wooden panel. Particularly functional: with drawer, 2 doors (can be used from both sides) and lateral height adjustable (73-100 cm) tiltable tray at 90° (27676) or swing type tray (27677).



Size: 50x33xh 85 cm.  
Lateral tray: 58x33 cm (27676),  
72x36 cm (27677).  
4 revolving castors (2 lockable).  
ABS border.



## 4 MOTORS, ELECTRICAL, ADJUST. HEIGHT BEDS - 3 JOINTS/4 SECTIONS



- **27683 4 MOTORS ADJUSTABLE HEIGHT BED - 24-65 cm**
- **27684 4 MOTORS ADJUSTABLE HEIGHT BED - 84-125 cm**

Three-joints, four section beds with adjustable height by fully electrical movements. Steel mainframe, surface with coating. Mattress platform with four sections, anti-sliding steel surface. Backrest-section and leg-section adjustable by means of two independent electric motors. Fixed pelvis-section. Head and foot boards made of solid beech wood with solid corners and edges. Legs fitted with 4 castors with independent brake. Richmat 4 motors and 5 functions hand controller. Supplied with lifting pole.

### TECHNICAL SPECIFICATIONS

	27683	27684
Size of platform:	90x200 cm	
Overall height:	24-65 cm	84-125 cm
Platform height:	-	38-79 cm
External measurement:	102x215 cm	
Max inclination of back section:	70°	70°
Max inclination of leg section:	25°	25°
Max inclination of overall bed:	12°	12°
Height of bed end from mattress platform:	-	46 cm
Max load:	180 kg	
Operating power:	220 V - 50 Hz	



# INTEGRATED SYSTEM OF TREVIRA® CURTAINS



## A COMPLETE SEPARATION SYSTEM

A complete system to create separations inside hospital rooms or outpatient wards.

**System includes**

**4 STRUCTURES - include rings**

- window curtain rails
- cabin curtain rail
- adjustable wall arms
- trolleys with 1 or 2 curtains

**3 SIZES TREVIRA® CURTAINS IN 6 COLOURS - do not include rings**

**Window curtains rails**

Available in 2 sizes: 160 cm (45492) need curtains 175xh 145 cm and 210 cm (45493) need curtains 225x145 cm

**Cabin curtain rails**

Size: 80x80 cm, need curtain 225xh 180 cm

**Swing arm curtains - manual or electrical**

Swing arm curtain is adjustable horizontally (180°) and can be bent down to 90° (45501 only) when not in use.

Telescopic tubular arm extension: open 210 cm, closed 88 cm (45500 and 45503) or 100 cm (45501).

Rings allow curtains to slide smoothly.

**Trolley curtains - 1 or 2 curtains**

Trolley made of stainless steel AISI 304 with 4 revolving castors (2 lockable). It allows the use of 1 curtain 225xh 145 cm (45505) or 2 curtains (45506), 1 long 225xh 145 cm and 1 short 175xh 145 cm. Arm can be bent down to 90° when not in use and curtain remains tied up.

GIMA code	STRUCTURE: ARM OR TROLLEY WITHOUT CURTAINS
45492	Window curtain rail 160 cm
45493	Window curtain rail 210 cm
45495	Cabin rail 80x80 cm
45500	Adjustable arm
45501	Adjustable foldable arm
45503	Electric adjustable arm*
45505	Trolley for 1 curtain - foldable
45506	Trolley for 2 curtains - foldable

## Trevira® curtains

Trevira® curtains are flame-proof (Class I), antiallergic, avoid bacterial growth, waterproof and highly resistant to abrasion. Thick welf to avoid dust infiltration and improve privacy, washable up to 60°C. Available in 6 colours.

Custom-made curtains are available on request.



TREVIRA CURTAINS			
FOR WALL ARMS AND CABIN	FOR TROLLEYS AND WINDOWS		COLOUR
	Long trolley arm/rail: 225xh145 cm	Short trolley arm/rail: 175xh145 cm	
225xh 180 cm			
45510	45520	45530	Light blue
45511	45521	45531	Blue
45512	45522	45532	White
45513	-	-	Beige
45514	-	-	Green
45515	45525	45535	Peach
Ø INT. X EXT. 34x48 mm / 39x53 mm			
45508	SET OF 18 RINGS - SPARE		
45509	Open rings for window rails and cabin		
	Closed rings for wall arms and trolleys		

\*Adjustable horizontally (180°) by electrical control



# I.V. STANDS

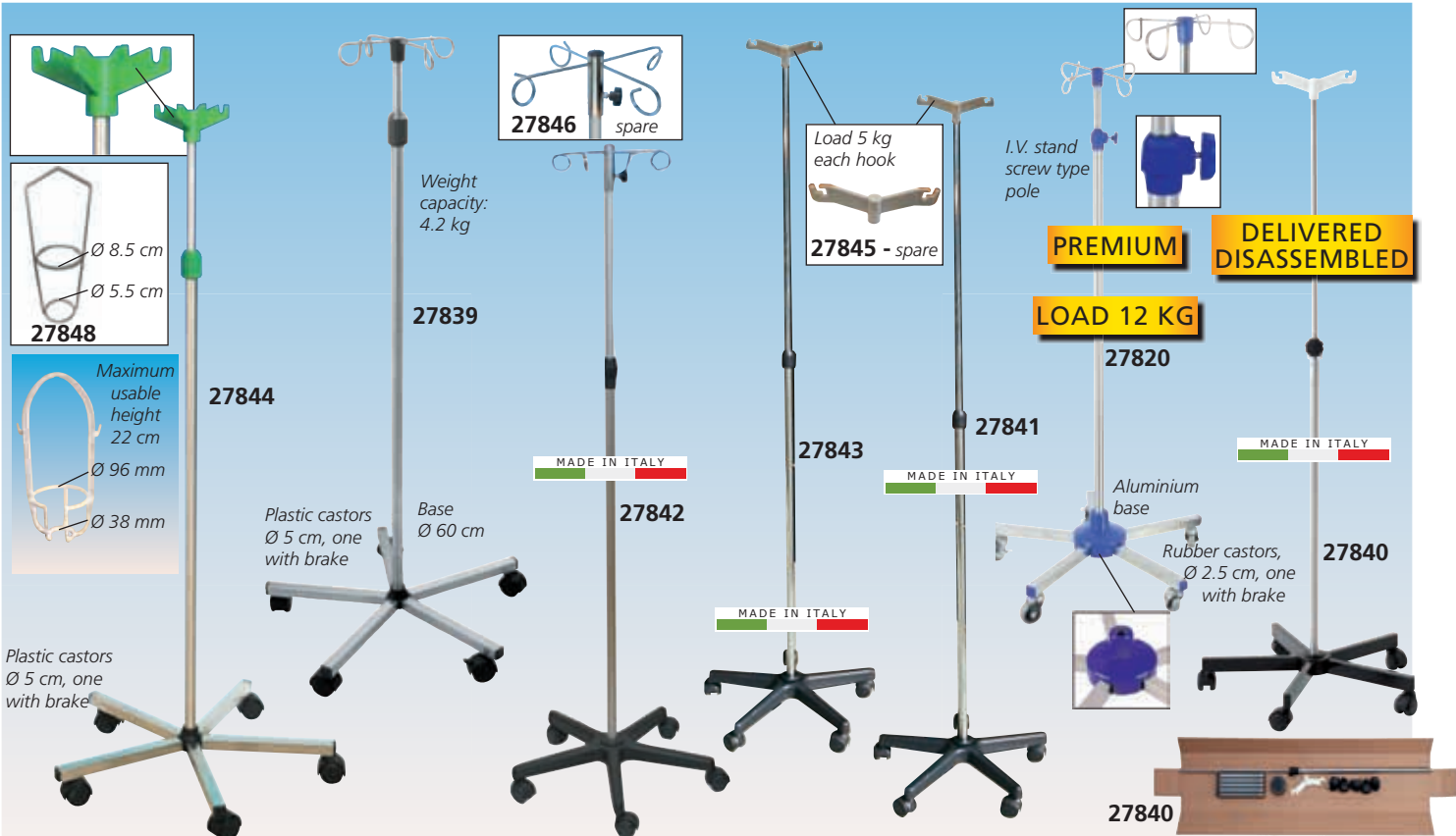

GIMA code	IV STANDS	Adjustable height	Weight kg	Base Material	Hook		Load kg		Castors with brake
					N	Material	Per hook	Total	
27839	Stainless steel AISI 304 IV stand	160-210 cm	3.3	stainless steel	4	stainless steel	1.2	5	1
27841	Chromed-steel IV stand	160-210 cm	2.9	plastic	2	plastic	5	10	-
27842	Chromed-steel IV stand	160-210 cm	3.2	plastic	4	metal	2	8	-
27843	Aluminium IV stand	165-210 cm	2.1	plastic	2	plastic	5	10	-
27840	Epoxy painted IV stand	160-220 cm	4.0	painted steel	2	plastic	5	10	-
27844	Stainless steel AISI 304 IV stand	135-215 cm	2.9	stainless steel	4	plastic	1.2	5	1
27820	Stainless steel AISI 202 IV stand	135-215 cm	3.5	aluminium	4	stainless steel	3	12	1
<b>ACCESSORIES FOR IV STANDS</b>									
27845	Plastic support for bottle holder - spare				2	plastic	5	10	
27846	Metal support for bottle holder - spare				4	metal	2	8	
27849	Stainless steel AISI 304 support for bottle holder - optional				2	stainless steel			
27847	Plastic bottle holder - box of 40 pcs.				-				
27848	Stainless steel AISI 304 bottle holder for bottle ≥ 1 l							2.5	

# INFUSION STANDS

- 27826 INFUSION STAND
  - 27829 INFUSION STAND with hydraulic pump
- Made of chrome plated steel. Four chrome plated steel hooks. Five spoke stainless steel base Ø 60 cm with castors Ø 50 mm, two with brake.



TECHNICAL SPECIFICATIONS		
	27826	27829
Adjustable height (cm):	160-250	189-260
Load (kg)*:	30	30
Weight (kg):	10	18
Frame for infusion pump (cm):	— 39x75 —	— — —
Packaging size (cm):	— 185x18x43 —	— — —

\*Load 5 kg each hook, 10 kg frame for infusion pump



# HYPODERMOCLYSIS STAND

- 27857 HYPODERMOCLYSIS STAND
- Stand with hydraulic height adjustment for hypodermoclysis, for washing and surgical irrigation. Hydraulic pump with pedal for height adjustment and gripping handle for easy transport.

Stainless steel adjustable gripping handle for easy transport

**LOAD 28 KG**



Pedal driven shock absorbing pump. Height adjustable: 147-247 cm Weight: 22 kg

Stainless steel base with 5 pivoting castors Ø 75 mm (2 antistatic with brake, 3 standard) and grey vipla bumpers.



## PATIENT TROLLEYS - STRETCHERS



Removable top on the trolley

Adjustable backrest up to a 60°

MADE IN ITALY

Multilingual instructions: GB, FR, IT, ES



27801



Side rails code 27810 (not included)

27800 and accessories (not included)

Oxy bottle holder code 27813 (not included)

Basket Code 27812 (not included)

- 27800 PATIENT TROLLEY
  - 27801 PATIENT TROLLEY - removable top
- Made of chrome plated steel tube. Comes complete with mattress made of washable self extinguishing plastic material. Mounted on 4 castors Ø 100 mm two of which with brakes. Size: 180x54xh 80 cm. Load: 110 kg.

GIMA code	PATIENT TROLLEY ACCESSORIES - not included
27810	Side rails (couple)
27811	I.V. Stands
27812	Steel basket only for 27800
27813	Oxygen bottle holder

## PROFESSIONAL WARD STRETCHER

MADE IN ITALY



44760 + accessories (not included)

FLAT PACK reduced shipping volume

### • 44760 WARD STRETCHER

Main features:

- **Platform:** all-welded mainframe made of semi-oval steel tube 50x25x2 mm.
  - **Undercarriage:** made of steel tube Ø 30x1.5 mm and oval steel tube 40x20x1.5 mm
  - **Push/Pull handle:** made of steel tube Ø 30x1.5 mm.
  - **Surface finish:** epoxy gloss finish standard grey 7040
  - **Mattress platform section:** two section mattress platform fitted with grids made of 5 mm Ø steel rods and square mesh 50x50 mm.
  - **Backrest:** square cross section 25x25x1.5 mm, adjustable by means of a rack device (5 positions).
  - **Castors** - four castors Ø 200 mm made of grey synthetic rubber two of which with independent brake.
  - **Bumpers:** Four bumpers at the corners made of anti-acid and anti-shock grey resin. Supplied disassembled.
- External size: 202x71xh 90 cm  
Wired net height: 78 cm  
Load: 135 kg.  
Manual: GB, FR, IT, ES.

GIMA code	WARD STRETCHER ACCESSORIES - not included
44761	Side rails (couple) with automatic locking device
44762	I.V. Stand with two hooks
44763	Basket - grey painted steel
44764	Oxygen bottle holder* - chrome plated steel
44765	Fireproof simulated leather mattress - class I - 182x64x4 cm

\*For oxygen bottle up to 41 cm, Ø 15,5 cm

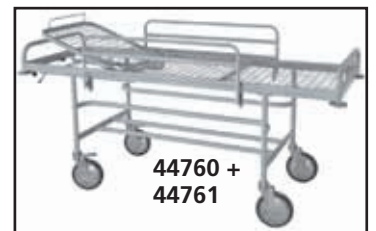

44760 + 44761

## TRENDELENBURG PATIENT TROLLEY - STRETCHER



Code 27810 side rails (not included)

Bumpers at all 4 corners

### • 27850 TRENDELENBURG TROLLEY

Made of steel-alloy, oven painted ral 9010, with chrome plated handles. Adjustable height from 50 to 70 cm, with oleodynamic pump. Trendelenburg up to 9°. Anti-Trendelenburg up to 14° (with gas pump). Plastic bumpers at four corners. Maximum load: 120 kg. 4 wheels of Ø 200 mm (2 with brake). Size: 65x184 (internal) x h 50-70 cm, 72x191 cm (external).

GIMA code	ACCESSORIES
27810	Side rails (couple) 100xh 28 cm
27853	I. V. Stands
27854	Oxygen bottle holder
27855	Mattress - black sky 3 cm thick in flame retardant material - 184x64x3 cm

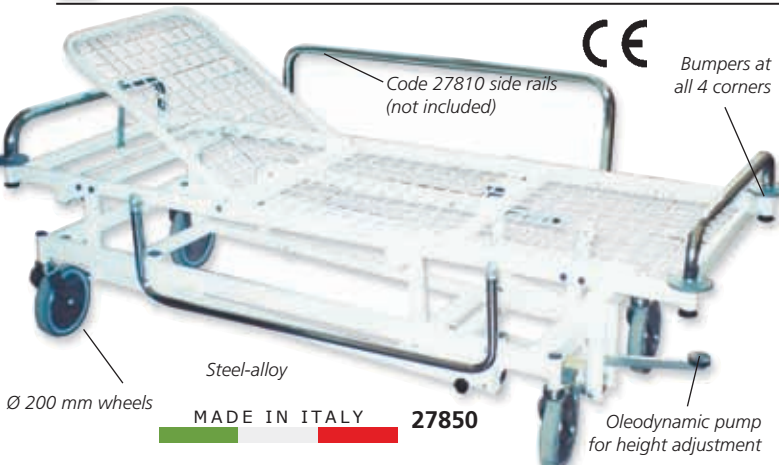

Ø 200 mm wheels

Steel-alloy

MADE IN ITALY

27850

Oleodynamic pump for height adjustment

## PROFESSIONAL PATIENT TROLLEY - ADJUSTABLE HEAD SECTION

- **27804 PROFESSIONAL PATIENT TROLLEY** with adjustable head section, side rails and oxygen cylinder holder
- **27805 PROFESSIONAL PATIENT TROLLEY - RADIOTRANSSPARENT FRAME** with adjustable head section, side rails and oxygen cylinder holder

Innovative, stylish comfortable trolley easy to use. Trolley made of sturdy tubular frame for optimal stability. Supplied with 4 wheels Ø 200 mm (2 with brake), bumpers, push handle. Detachable frame with adjustable head section (27804) or fixed frame, 12 mm thickness, with adjustable head section (27805).

Size: 196x76xh 75 cm. Net size: 193x68 cm  
Maximum load: 200 kg.  
Weight: 70 kg.

- **27809 MATTRESS - 190x68xh 8 cm - blue**  
Made of 45% polyester, 55% polyurethane. Fire retardant, Class 1. Antistatic and antibacterial. Density: 30 kg/m<sup>3</sup> ±5%

- **27808 IV STAND** with 2 plastic hooks.

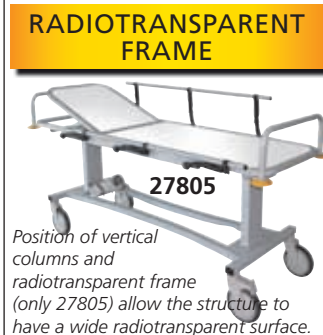

## ADJUSTABLE HEIGHT PATIENT TROLLEY WITH TR AND RTR

- **27806 PATIENT TROLLEY - with adjustable height, TR and RTR**  
Stylish sturdy and comfortable trolley with innovative design. Adjustable height by means of hydraulic pump with pedal placed on both sides. Lateral sides, easy and fast to fold. The upper wire mesh is removable to guarantee a better hygiene. Equipped with push handles, 4 bumpers at the corners and a universal hold-cylinder. Reclinable cushion by two racks easily actuated by the grip handle. Wheels 200 mm diam. with total and simultaneous central brake; one of 4 wheels is equipped with directional brake; activated by means of 4 lateral pedals. The joints of the structure rotate on self-lubricating sintered threaded inserts. The trolley can reach the Trendelenburg (-10°) and anti-Trendelenburg (+10°) position very quickly thanks to a handle placed on the upper lateral side: it activates a gas spring (600N) that allows millimetric adjustability. The entire structure, in rectangular and round tubular is epoxy painted in grey and white colour.

Size: 199x76xh 52/87 cm (without mattress).  
Load: 130 kg. Weight: 90 kg

- **27809 MATTRESS - 190x68xh 8 cm - blue**  
Made of 45% polyester, 55% polyurethane. Fire retardant, Class 1. Density: 30 kg/m<sup>3</sup> ±5%. Antistatic and antibacterial.
- **27808 IV STAND** with two plastic hooks



## HYDRAULIC HEIGHT ADJUSTABLE PATIENT TROLLEY - TR and RTR

- **44790 HEIGHT ADJUSTABLE PATIENT TROLLEY - TR and RTR**  
Two-section variable-height stretcher with adjustable backrest by gas devices up to 65°. Top made of radiolucent Hpl, steel frame and long leg section made of painted steel. Possibility of insertion of cylinder basket and four IV poles, two in the head and two in the foot area. Side bumpers on the frame for protection of the stretcher. Two collapsible handles on the head side and one on the foot side, all in painted steel, to provide a safe and comfortable grip. Adjustable height 530 to 890 mm by a large pedal located in the foot area. All steel parts are epoxy powder coated. Manual Trendelenburg and Reverse Trendelenburg (±18°) by lever located at the foot side of the stretcher. Sturdy folding steel side rails with compass movement. Four castors Ø 200 mm with simultaneous brake controlled by centralized pedal, directional ones at the head.

- **44793 WATERPROOF, FIREPROOF, RADIOTRANSSPARENT MATTRESS 6 cm**

Mattress with waterproof, washable, atoxic cover. Mattress allows cardio massage.

- **44794 I.V STAND 4 HOOKS**
- **44795 OXYGEN BOTTLE HOLDER**
- **44796 STORAGE BASKET**

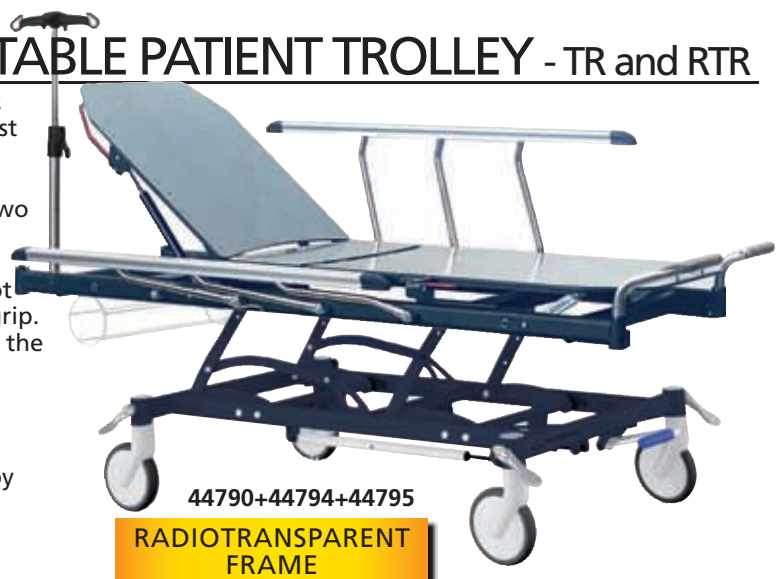

TECHNICAL SPECIFICATIONS	
Overall size:	2000x825xh 530-890 mm
Table size:	1900x630 mm
Max. backrest inclination:	65°
Safe working load:	230 kg
Norms:	2017/745 EU, Medical Device Class I

## PATIENT TRANSPORTATION TROLLEY - WITH TR AND RTR

- **44792 HYDRAULIC HEIGHT ADJUSTABLE PATIENT TROLLEY ON COLUMNS WITH TR AND RTR - side rails included**  
Patient trolley with 1 joint, 3 sections and HPL radiolucent top. Head section continuously adjustable by gas devices up to 80°; back section moved by gas assist and foot section moved by rastomat. Epoxy powder-coated steel frame with multifunctional supports at the corners allowing insertion of up to two accessories per corner such as drip poles, monitor holders or others. Base with protective cover and compartment for gas bottles and objects. Equipped with four 200 mm Ø swivel castors and one with directional lock. Centralised, simultaneous braking system by means of a pedal located on the foot side. Folding handles at foot end. Pair of folding side rails with compass movement made of extruded aluminium alloy with automatic lock and double lowered position. Optional height-adjustable IV pole with 4 hooks. Large foot pedal on both sides of the stretcher to adjust height from 550 to 850 mm. Pedals on both sides for lowering and reaching the Trendelenburg and Reverse Trendelenburg positions (- 18° / + 18°). Control pedal with three positions: 1 free, 1 directional and 1 total lock. Suitable for transport even over long distances.
- **44793 WATERPROOF, FIREPROOF, RADIOTRANSSPARENT MATTRESS 6 cm - optional**
- **44794 I.V STAND 4 HOOKS - optional**
- **44795 OXYGEN BOTTLE HOLDER need also 44796 - optional**
- **44796 STORAGE BASKET need also 44795 - optional**

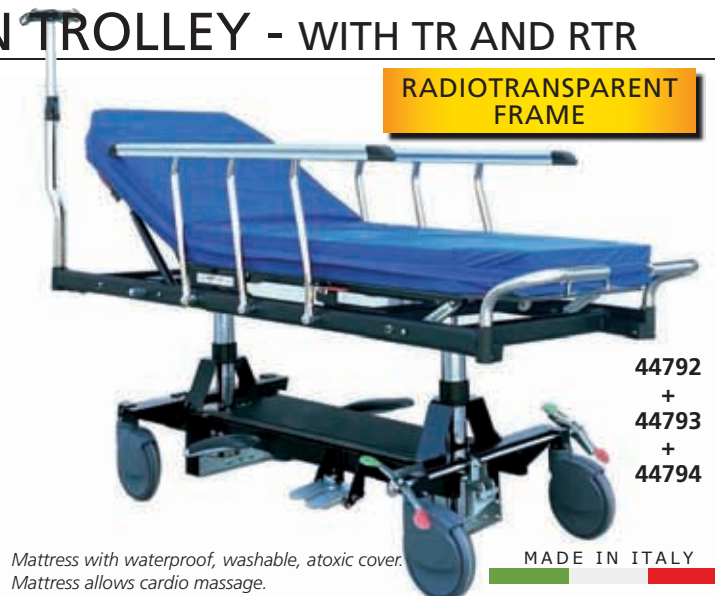

44792  
+  
44793  
+  
44794

Mattress with waterproof, washable, atoxic cover.  
Mattress allows cardio massage.

MADE IN ITALY

TECHNICAL SPECIFICATIONS	
Overall size:	2060x820xh 550-850 mm
Size - weight:	1950x650 mm - 105 kg
Max. backrest tilt:	80°
Trendelenburg / RTR:	- 18° / + 18°
Safe working load:	320 kg                      Max. patient load: 260 kg
Norms:	MDR 2017/745; Medical Device Class I

## HYDRAULIC HEIGHT ADJUSTABLE PATIENT TROLLEY - WITH TR AND RTR

- **44782 HYDRAULIC HEIGHT ADJUSTABLE PATIENT TROLLEY with TR and RTR**  
Metal patient trolley equipped with foldable aluminium alloy guardrails and two hydraulic pumps which allow height adjustment, Trendelenburg and reverse Trendelenburg. Four double castors Ø 20 cm, lockable by pedals on both sides. Waterproof PU mattress. Four detachable bumper wheels Ø 74 mm to protect bed and patients during transportation. Stainless steel IV pole with plastic hooks. X-ray translucent bed platform. Central wheel to facilitate direction control.



Stainless steel IV pole

Drainage hooks

Pedal to adjust leg, back and base

44782

TECHNICAL SPECIFICATIONS		
Size:	2100x850 mm	Knee-rest adjustment: 0-45°
Height adjustment:	630-930 mm	Trendelenburg: 0-15°
Back-plate adjustment:	0-75° (± 10°)	Reverse Trendelenburg: 0-15°
STANDARD ACCESSORIES		
1 set emergency push handle	4 IV pole provisions	1 set IV pole
1 set folding side rails	1 mattress	

## HEIGHT ADJUSTABLE PATIENT TROLLEY

- **44780 HEIGHT ADJUSTABLE PATIENT TROLLEY**  
Height adjustable patient trolley made of metal. Both bed frame and chassis have 30x50 mm square tube to make stretcher stronger and more stable. Bed platform and guardrail are made of high quality PP material. Back lift makes patient more comfortable. Equipped with strips to prevent patients from possibly sliding off the stretcher and 2 cm thickness mattress. Directional wheel and central locking pedals.



44780

Directional central wheel to facilitate direction control

Four double side castors Ø 15 cm lockable by pedal

TECHNICAL SPECIFICATIONS	
Size:	1900x640 mm
Height adjustment:	550-850 mm
Back-plate adjustment:	0-70° (± 10°)
STANDARD ACCESSORIES	
1 set IV pole	1 transfer mattress
2 IV pole provisions	2 strips
1 oxygen bottle holder for 2 l bottle	1 set ABS folding side rails

# ELECTRIC OPERATING TABLE WITH TR AND RTR

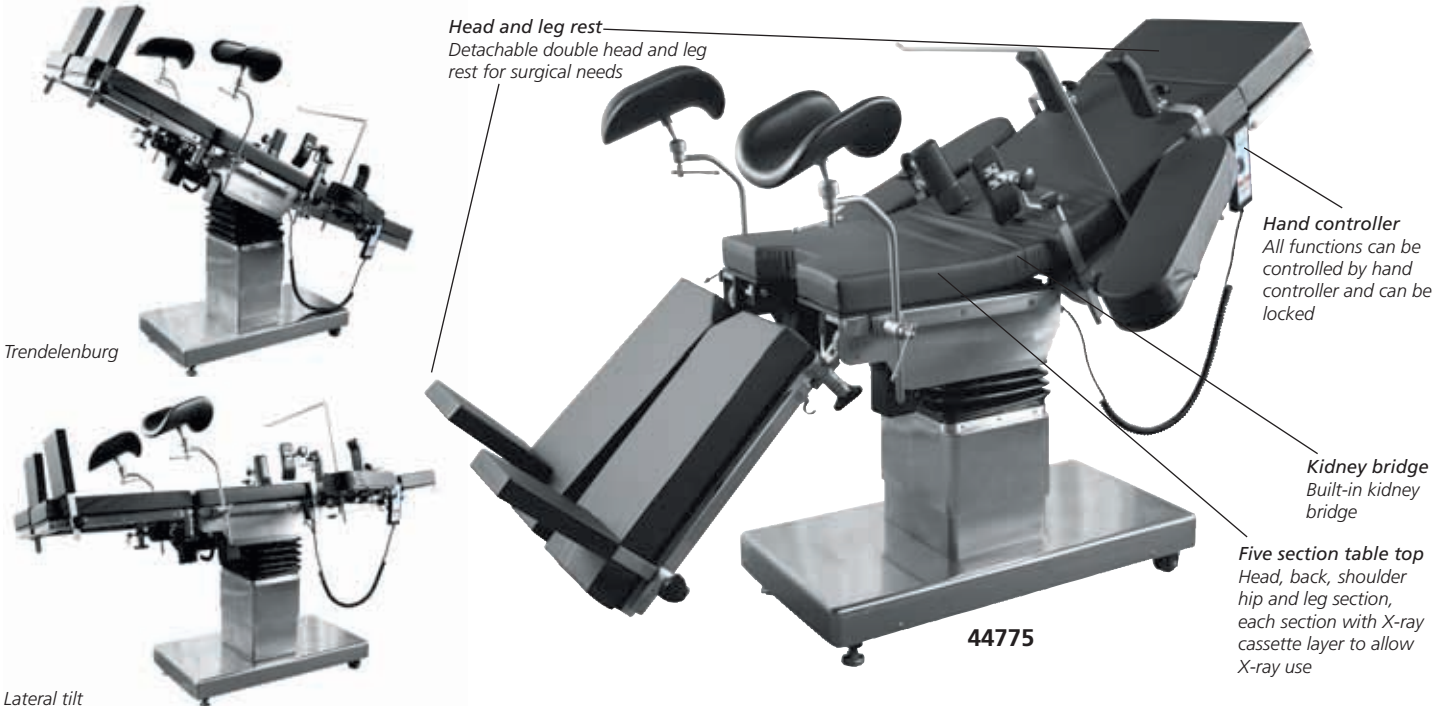

**• 44775 ELECTRIC OPERATING TABLE with TR and RTR**  
 Electric operating table for general surgical procedures, mainly made of 304 stainless steel.  
 It is driven by low-voltage DC motor with safe and stable performance. Table movements can be controlled by means of an easy-to-use hand controller.  
 Super wide table top, super long sliding distance.  
 Leg rest with integrated gas spring for easy control.  
 Suitable for X-ray and C-arm surgery thanks to an extra-long horizontal sliding. Max. load: 200 kg.

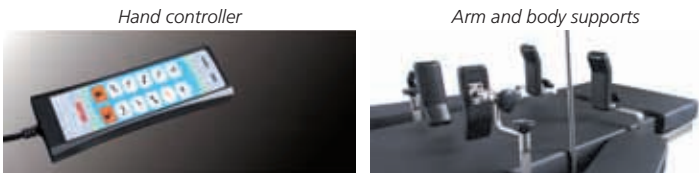

TECHNICAL SPECIFICATIONS	
Size:	210x50xh 80-100 cm
Max. load:	200 kg
Trendelenburg:	0-25°
Reverse Trendelenburg:	0-22°
Lateral tilt (left/right):	0-20°
Head rest (up/down):	0-45°/0-90°
Back plate (up/down):	0-75°/0-20°
Foot plate (up/down):	0-15°/0-90°
Foot plate horizontal positioning:	0-90°
Horizontal sliding:	30 cm
Kidney bridge elevation:	11 cm
Voltage:	110-220 V, 50/60 Hz
Power capacity:	1.0 Kw
STANDARD ACCESSORIES	
Mattress	2 leg supports with cushion
1 anesthesia screen frame	2 foot supports with cushion
2 shoulder holders with cushion	1 kidney bridge handle
2 arm holders with cushion	1 IV stand

## INOX WORKING TABLE



**• 27909 INOX WORKING TABLE**  
 Working table, equipped with two drawers (47x30x12 cm) each side, to work on both sides. Stainless steel AISI 304 frame, structure made of square tubular, table top and lower shelf made of smooth stainless steel. Mounted on 4 castors Ø 100 mm, two with brakes. Size 120x70xh 95 cm. Weight 50 kg. Max load (x shelf): 40 kg. Delivered in kit form 122x35x72 cm

## OPERATING THEATRE INSTRUMENT TABLES



**• 27913 INSTRUMENT TABLE 2 SHELVES**  
 Operating room instruments table made of stainless steel AISI 304 scotch brite finish. 125 mm Ø revolving castors (2 with brake). Weight: 28 kg. Load for shelf: 40 kg. Size: 120x65xh 95 cm. Delivered in kit form (123x13x68 cm).



**• 27914 INSTRUMENT TABLE 1 SHELF**  
 Operating room instruments table made of stainless steel AISI 304, scotch brite finish. 125 mm Ø revolving castors (2 with brake). Weight: 21 kg. Load: 40 kg. Size: 120x65xh 95 cm. Delivered in kit form (123x13x68 cm).

## OPERATING ROOM INOX CABINETS

27917



MADE IN ITALY

• **27917 INOX CABINET**

Made of AISI 304 stainless steel. Two lockable doors (10/10 thickness), 4 adjustable shelves (8/10 stainless), 4 adjustable feet, with stainless steel cover. Size: 100x48xh 190 cm. Weight: 130 kg.

27918



MADE IN ITALY

• **27918 GLASS-INOX CABINET**

Made of AISI 304 stainless steel with two lockable doors in tempered glass 5 mm thick, 4 shelves in tempered glass 6 mm thick and 4 adjustable feet. Size: 100x48xh 190 cm. Weight: 105 kg.

## CABINET - PAINTED STEEL

27916



MADE IN ITALY

• **27916 PAINTED STEEL CABINET**

Epossidic powder painted steel cabinet with 4 adjustable shelves, lockable doors, 4 adjustable feet. Size: 100x50xh 200 cm.



## SHELVING SYSTEM



MADE IN ITALY

27908

• **27908 SHELVING SYSTEM**

Shelving system, made of AISI 304 stainless steel, scotch brite finish. With 5 stainless steel reinforced shelves at fixed position. Possibility to fix together several shelving systems. Size: 100x50xh 200 cm Load x shelf: 25 kg Weight: 30kg

3 shelving systems fixed together



## INSTRUMENT TROLLEY



MADE IN ITALY

27442

• **27442 INSTRUMENT TROLLEY**

Made of satined welded AISI 304 stainless steel. With 4 sliding drawers (internal, 49x33xh 18 cm) Top drawer lockable, upper shelf with safety edges to carry instruments. 4 revolving castors Ø 80 mm Size: 60x40xh 110 cm Weight: 37 kg

## ANAESTHETIC TROLLEY



MADE IN ITALY

27437

• **27437 ANAESTHETICS TROLLEY**

Made of satined AISI 304 stainless steel, with 6 drawers (internal 26x37xh 7 cm), a lockable vertical compartment and an open space. Top with 3.5 cm upstand. 4 revolving castors Ø 80 mm Size: 60x40xh 110 cm Weight: 39 kg

Drawers are locked once vertical compartment is locked

## BOWL STANDS

- 27456 SINGLE BOWL STAND
- 27457 DOUBLE BOWL STAND

Chrome plated steel stand with stainless steel base and 5 plastic wheels, one with brake. Adjustable height from 60 to 95 cm. Stainless steel bowl Ø 32 cm, 4 l capacity included.

Available with one or two bowls. **Delivered in kit form.**

- 27459 S/S BOWL Ø 32 cm - spare

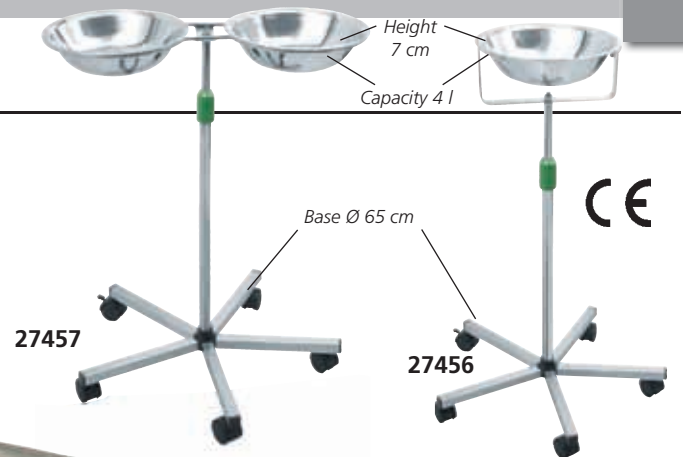

## MAYO TABLES



Fixed tray with 360° rotation

27453



27455

27454

Tray internal size: 70x45xh 1.7 cm



45832



45830

- 27453 MAYO TABLE - 5 spokes
- S/s tray, 5 spokes with castors, Ø 50 mm and adjustable height. Manual: GB, IT.
- Delivered in kit form.**

- 27454 MAYO TABLE - s/s base
- 27455 MAYO TABLE - s/s base and pump
- With removable s/s tray, s/s AISI 304 base with 4 castors (50 mm) and adjustable height. **Delivered in kit form.** Manual: GB, IT.

- 45830 MAYO TABLE - U-SHAPE
- 45832 MAYO TABLE - 5 spokes
- Stainless steel base with castors Ø 50 mm: 5 spokes (45832) or U-shape (45830). Stainless steel frame and removable tray. Adjustable height. **Delivered in kit form.**

### TECHNICAL SPECIFICATIONS

	27453	27454	27455	45830-45832
S/S tray size:	68x44 cm	70x45 cm	70x45xh 1.8 cm	70x45xh 1.7 cm
Adjustable height:	70-110 cm	74-110 cm	85-120 cm	90-115 cm
Weight:	8 kg	12 kg	19 kg	10 kg
Load:	20 kg	40 kg	40 kg	10 kg

## MAYO TABLES WITH PUMP



45834



45835

- 45834 HYDRAULIC MAYO TABLE with pump
- Serving trolley used as instrument holder in operating rooms. Not removable tray made of AISI 304 stainless steel. Equipped with hydraulic pump for height adjustment. Base made of aluminium with 5 spokes and swiveling castors Ø 50 mm. **Delivered in kit form.**

- 45835 HYDRAULIC MAYO TABLE with pump and removable tray
- Height adjustable instruments trolley with removable tray in AISI 304 stainless steel, scotch brite finish. Tray can be rotated through 360° with tightening knob. Base in AISI 304 stainless steel tubular frame fixed to the hydraulic pump that allows height adjustment by foot pedal. Three castors Ø 75 mm, one antistatic and two with brake. **Delivered in kit form.**

### TECHNICAL SPECIFICATIONS

	45834	45835
S/S tray size:	70x45xh 1.8 cm	
Adjustable height:	85 to 120 cm	90 to 126 cm
Load:	40 kg	20 kg
Weight:	14 kg	17 kg
Packing size:	60x17xh 77 cm	98x68xh 15 cm

## REX TROLLEY



27439

MADE IN ITALY

- 27439 REX TROLLEY
- Complete stainless steel dressing trolley. Supplied with 3 shelves, waste bin, drawer, support for bottles, guard rails on the two bottom shelves, 4 wheels, Ø 100 mm (2 with brakes). Load 50 kg. Size: 79x50xh 120 cm (handle included). Drawer size 64x43xh 9.5 cm. **Delivered in kit form (114x54x37 cm).**

## STAINLESS STEEL INSTRUMENT AND DRESSING TROLLEYS



27430

MADE IN ITALY

• **27430 INOX TROLLEY**  
AISI 304 Stainless steel trolley with plastic drawer internally divided in 4 sectors. 2 shelves with upstands (3,5 cm) on four sides. Revolving rubber castors Ø 80 mm (two with brake).  
Size: 70x50xh 82 cm.  
Max load (x shelf): 25 kg.  
**Delivered in kit form.**



27433

MADE IN ITALY

Delivered in kit form.

• **27433 MEDICAZIONE TROLLEY - small**  
Size: 60x40xh 81 cm - weight 8 kg  
• **27434 MEDICAZIONE TROLLEY - medium**  
Size: 70x50xh 82 cm - weight 9 kg  
• **27435 MEDICAZIONE TROLLEY - large**  
Size: 90x60xh 85 cm - weight 15 kg  
AISI 304 stainless steel trolleys, with push handle, 2 shelves with upstands (3,5 cm) on four sides, 4 revolving rubber castors Ø 80/80/100 mm. Max load (x shelf): 25 kg.



27431

MADE IN ITALY

• **27431 TER TROLLEY**  
AISI 304 Stainless steel trolley, with push handle. 3 shelves with upstands (3,5 cm) on four sides, 4 revolving rubber castors Ø 80 mm.  
Size: 70x50xh 82 cm - weight 13 kg  
Max load (x shelf): 25 kg  
**Delivered in kit form.**



27436

MADE IN ITALY

Delivered in kit form.

• **27436 DRESSING TROLLEY**  
Dressing trolley made of AISI 304 stainless steel with 2 shelves (70x50 cm), 1 drawer (40x50xh 15 cm), basin holder and basin. 4 revolving castors Ø 100 mm.  
Size: 70x50xh 85 cm - weight: 18 kg.  
Max load (x shelf): 25 kg.



45800

MADE IN ITALY

• **45800 MEDICAZIONE PLUS TROLLEY**  
**With removable trays**  
Stainless steel frame mounted on castors Ø 80 mm.  
Size: 61x43xh 78 cm. Weight: 10 kg.  
Maximum load (x shelf): 10 kg.  
**Delivered in kit form.**



45805

MADE IN ITALY

• **45805 TER PLUS TROLLEY**  
**With removable trays**  
Stainless steel frame, mounted on castors Ø 80 mm.  
Size: 49x30xh 78 cm. Weight: 9 kg.  
Maximum load (x shelf): 10 kg.  
**Delivered in kit form.**

## STAINLESS STEEL TROLLEYS WITH ABS SHELVES

- **45791 UTILITY TROLLEY 3 shelves**
- **45792 UTILITY TROLLEY 2 shelves + 1 drawer**

Practical trolleys with stainless steel frame and two or three high quality ABS shelves. All shelves provided with three-sided stainless steel siderails to prevent items from falling down. Two push handles for easy moving. Wear resistant, high quality silent castors, Ø 100 mm, two with brake.  
Size: 73x48x90 cm  
Drawer size: 50x42x12 cm (45792 only).  
Max load: 60 kg (30 kg per shelf).



45791



45792



## ALUMINIUM TROLLEYS



- **27429 GIMA 2 TROLLEY**  
- small: 60x40xh 77 cm - weight 11 kg
  - **27425 GIMA 2 TROLLEY**  
- medium 70x50xh 78 cm - weight 14 kg
- Practical trolleys with aluminium body and handles. Two white bilaminated shelves 18 mm thick, black PVC bordered, with guard-rail. Two large lateral handles facilitate transport or lift up of the trolley. 4 revolving nylon castors Ø 80 mm. Max load (x shelf): 40 kg.
- **27426 GIMA 3 TROLLEY** - medium 70x50xh 78 - weight 15 kg. Same as GIMA 2, but without guard rail. Delivered in kit form.

## ANODIZED ALLOY TROLLEYS

TOP QUALITY



- **27460 DELUXE TROLLEY**
  - **27461 DELUXE TROLLEY with drawer**
  - **27422 DELUXE TROLLEY with 2 drawers**
- Size: 65x45xh 80 cm  
Drawer size: ext. 58x40xh 10.5 cm, int. 51.5x38.5xh 8.5 cm.
- Top quality trolleys made of lightweight anodized special alloy with detachable stainless steel shelves. 4 revolving rubber castors Ø 80 mm. Max load (x shelf): 20 kg. Instructions: GB, FR, IT, ES PT, DE, GR. Delivered in kit form.

## LANCART: STAINLESS STEEL TROLLEYS TO BUILD UP



**LANCART TROLLEYS**  
Stainless steel trolleys mounted on castors Ø 80 mm. Maximum trolley load: 60 kg. Range of optional accessories to customize your trolley. Drawer size (45808-45809 only): 29x30xh 7.5 cm. Delivered in kit form.

MADE IN ITALY

GIMA code	LANCART TROLLEYS	Size	Shelves	Drawer
45810	Lancart trolley - small	60x40xh 80	2	-
45811	Lancart trolley - medium	72x50xh 80	2	-
45812	Lancart Ter trolley - small	60x40xh 80	3	-
45813	Lancart Ter trolley - medium	72x50xh 80	3	-
45808	Lancart trolley - small	60x40xh 80	2	yes
45809	Lancart trolley - medium	72x50xh 80	2	yes
ACCESSORIES FOR LANCART				
45815	Set of siderails (for 1 shelf) for 45808, 45810, 45812			
45816	Set of siderails (for 1 shelf) for 45809, 45811, 45813			
45817	Bottle rack			
45818	Waste bin			



## SMART CARTS - WITH 2, 3 OR 4 SHELVES OR DRAWER

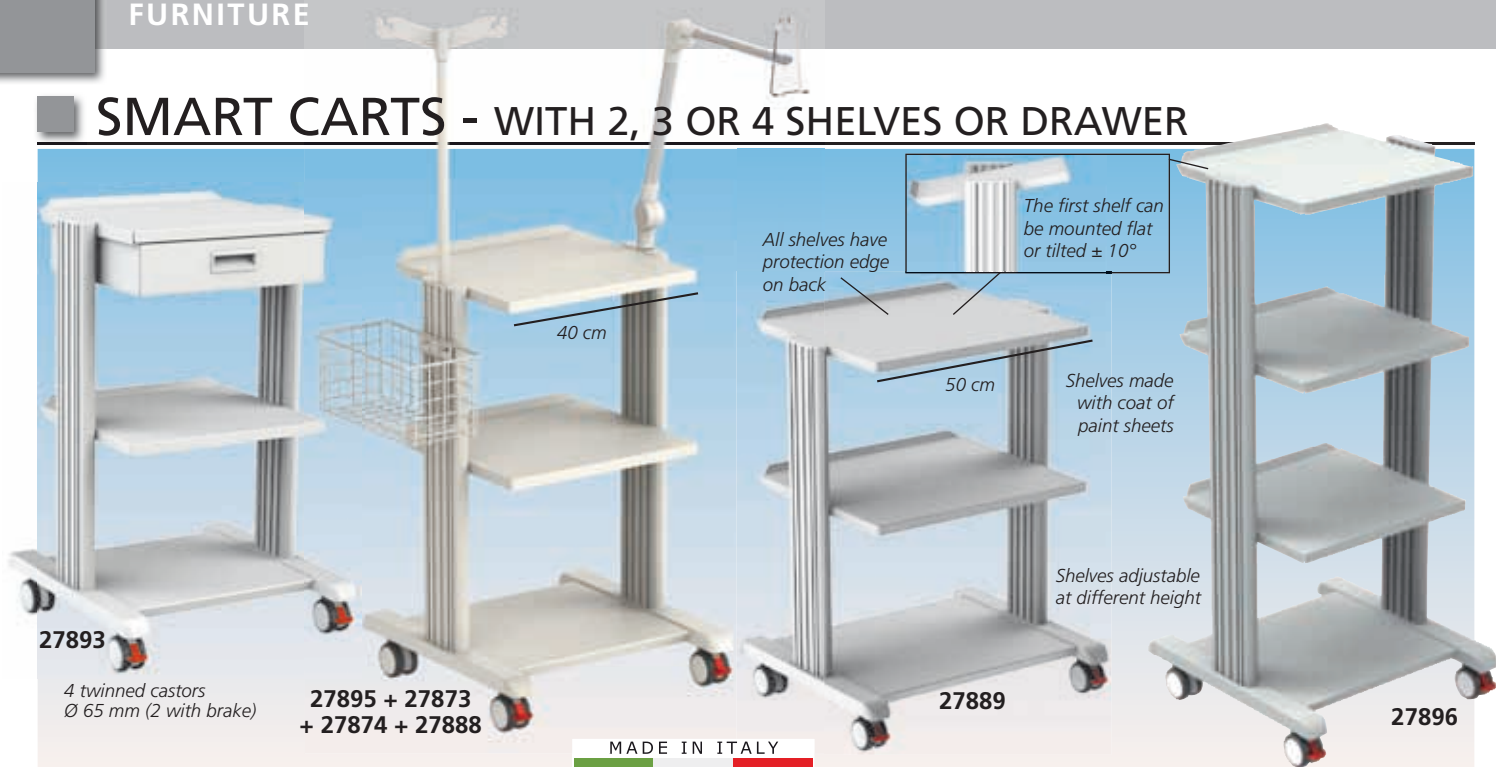

**SMART CARTS - grey/white RAL 7035**  
 Carts with base and 2, 3, or 4 wide, sturdy shelves in 3 different widths 40, 50 or 60 cm.  
 Aluminium columns and 4 twinned castors  $\varnothing 65$  mm (2 with brake).  
 First shelf can be mounted flat or tilted  $\pm 10^\circ$ .  
 Fully removable drawer (27893-4) without ball bearing guides.  
 Designed for medical devices.  
 Illustrated assembly instructions.

TECHNICAL SPECIFICATIONS	
Dimensions (cm):	48,2x50x78 (27893, 27895) 58,2x50x78 (27894, 27889) 48,2x50x88 (27896) 48,2x50x115 (27897) 68,2x50x78 (27890)
Load capacity:	total load 80 kg, shelf 15 kg
Material:	- vertical aluminium extrusions - plastic parts in ABS
Shelf:	steel sheet epoxy powder coated
Total weight:	13 kg (27895) 15 kg (27893, 27896, 27889) 17 kg (27890) 18 kg (27897) 18.5 kg (27894)

GIMA code	SMART CARTS	Height (cm)
27893	2 shelves 40x36 cm + base + drawer	78
27894	2 shelves 50x42 cm + base + drawer	78
27895	2 shelves 40x36 cm + base	78
27896	3 shelves 40x36 cm + base	88
27897	4 shelves 40x36 cm + base	115
27889	2 shelves 50x42 cm + base	78
27890	2 shelves 60x42 cm + base	78
ACCESSORIES FOR SMART CARTS		
27873	Basket	
27874	Infusion stand - fixed height*	
27888	Cardio arm for ECG	

\*Trolley with adjustable height infusion stand available on request in 40 days

## EASY AND EASY POWER CARTS

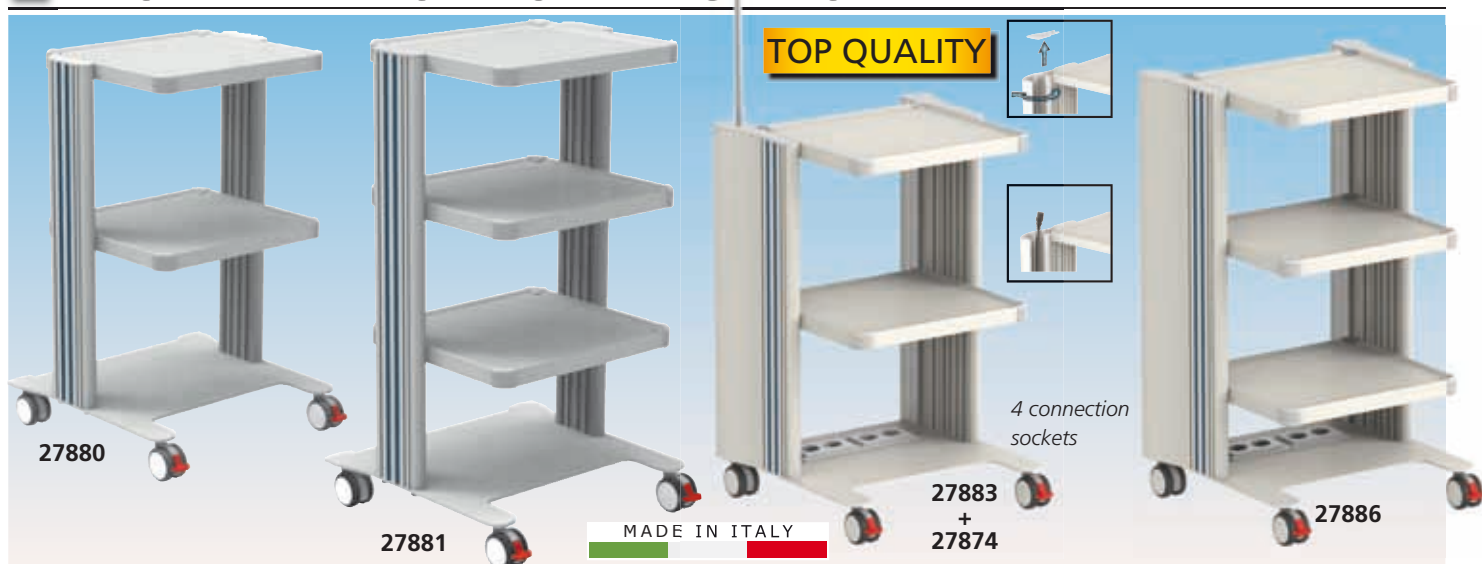

**EASY CARTS AND EASY POWER CARTS**  
 A complete line of stylish and sturdy carts with 2, 3 or 4 shelves and with power.  
 Adjustable height of sturdy shelves, aluminium columns and 4 twinned castors  $\varnothing 65$  mm (2 with brake).  
 All shelves with anti-fall edges.  
 Designed for medical devices.  
 Illustrated assembly instructions.  
**Easy power carts**  
 Easy power carts are equipped with cable pipe inside lateral columns and 4 connection sockets.

TECHNICAL SPECIFICATIONS	
Dimensions (WxDxH):	50x45x75/83.5/107.5 cm (Easy) 50x45x75/83.5 cm (Easy power)
Load capacity:	total load 140 kg shelf 25 kg
Shelves:	40x36 cm
Castors:	4 twinned castors $\varnothing 65$ mm (2 with brake)
Material:	- vertical aluminium extrusions - plastic parts in ABS
Shelf:	steel sheet epoxy powder coated

GIMA code	EASY CARTS	Height (cm)
27880	2 shelves 40x36 cm + base	75
27881	3 shelves 40x36 cm + base	83.5
27882	4 shelves 40x36 cm + base	107.5
EASY POWER CARTS		
27883	2 shelves 40x36 cm + base	75
27886	3 shelves 40x36 cm + base	83.5
ACCESSORIES EASY AND EASY POWER CARTS		
27873	Basket 30x16xh 14.5 cm	
27874	Infusion stand - fixed height*	
27884	Extra shelf 40x36 cm	
27888	Cardio arm for ECG	

\*Trolley with adjustable height infusion stand available on request in 40 days

# SUPER EASY MULTIFUNCTIONAL CARTS

**BUILD UP YOUR CART**  
YOU CAN ADD: EXTRA SHELF, BASKET,  
INFUSION STAND, CARDIO ARM

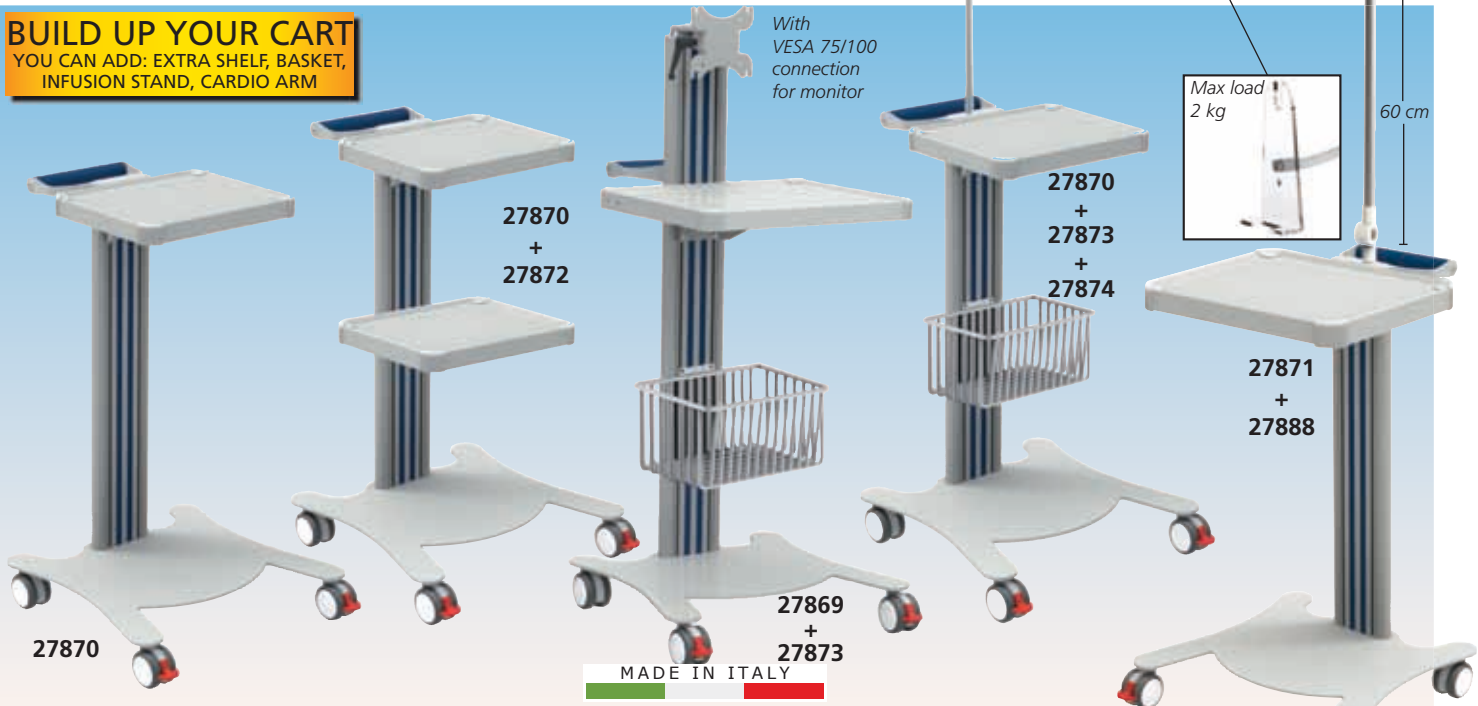

**SUPER EASY CART:** A new stylish and quality cart you can build according to your needs. Carts with base and 1 or 2 sturdy shelves, aluminium columns and 4

twinned castors Ø 65 mm (2 with brake). Illustrated assembly instructions.

GIMA code	SUPER EASY CARTS - with handle	Shelf size (cm)
27870	Cart + shelf + base	32x26
27871	Cart + shelf + base	40x36
27869	Cart + shelf + base + monitor support*	40x36

GIMA code	ACCESSORIES for SUPER EASY CARTS
27872	Extra shelf 32x26 cm
27873	Basket
27874	Infusion stand - fixed height**
27875	Extra shelf 40x36 cm
27888	Cardio arm for ECG (not suitable for 27869)

TECHNICAL SPECIFICATIONS	
Dimensions:	47x42x79 cm (27870-1) 47x42x102 cm (27869)
Load capacity:	total 120 kg - shelf 10 kg 4 twinned castors Ø 65 mm (2 with brake)
Material:	- extrusions in aluminium - plastic parts in ABS
Shelf:	steel sheet epoxy powder coated

\*Can not be used with 27874

\*\*Trolley with adjustable height infusion stand available on request in 40 days

# TROLLEY FOR PATIENT MONITORS, VENTILATORS, ...

• **45760 TROLLEY FOR MONITORS - without plate adapter**  
Trolley specially designed for support and mobility of patient monitors and ventilators of most manufacturers. Trolley needs plate adapter (not included) to be chosen depending on brand/model.

- 10 mm thickness steel base with high resistance ABS cover
- column in extruded aluminium with epoxy powders oven coated surface treatment
- ergonomic rear handle in ABS with reinforced structure
- 5 twin pivoting anti-noise castors Ø 65 mm made of thermoplastic rubber and ABS, 3 with brake
- Storage basket made of ABS plastic (30.5x15.6xh 14.9 cm).
- Size: 52.5x50xh 105 cm.
- Max load: 15 kg.

MADE IN ITALY

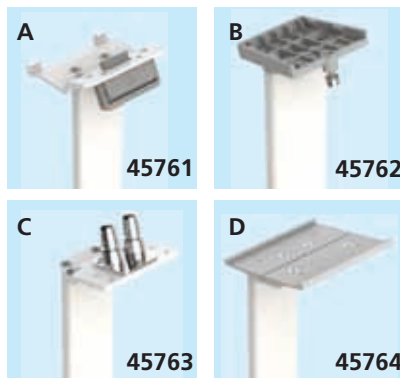

GIMA Code	Type	PLATE ADAPTERS
45761	A	Mindray adapter
45762	B	Philips adapter
45763	C	Philips "Horn" adapter
45764	D	Other brands adapter

GIMA Code	Type	BRAND	MODEL
45764	D	Colin	Press-Mate 8800
45764	D	Fukuda Denshi	Dynascope DS-8007 and DSA-81
45764	D	General Electric	GE Dash 2000, 3000, 4000 monitors Carescape B650, B450 Carescape B20, B40, B105, B125 Root M series Rad-97 M series
45764	D	Masimo	Rad-97 M series
45761	A	Mindray	ePM Compact: ePM10-12-15 ePM Modular: ePM10M, ePM12M Vet iPM: iPM 8-10-12, iMEC: iMEC 8-10-12 uMEC: uMEC 8-10-12 Benevision: N12-15-17 VS600, VS900 Accutor 3-7
45764	D	Nellcor	N-595, N-550 Pulse Oximeter Bedside SpO <sub>2</sub> PM100N
45764	D	Nihon Kohden	Life Scope i, Life Scope L, BSM 2301, BSM 2303 Vismo PVM 2700, Vismo PVM 4000 Life Scope VS, BSM 3500, BSM 3700, Vismo PVM 2700 Life Scope P, BSM 4103, BSM 4113 Life Scope A, BSM 5105, BSM 5135 Life Scope TR, BSM 6301K, BSM 6501K, BSM 6701K Life Scope G5, Life Scope N, OPV 1500 GF-210R Multigas Unit CSM-1501, CSM-1502, BSM-6XXX, WEP-5200, GF-200 series Capnostream™ 20 and Capnostream™ 20p Efficia CM10-12-100-120-150 EarlyVue VS30
45764	D	Oridion	IntelliVue MP5-20-30-40-50-60-70
45764	D	Philips	IntelliVue MX400-450-500-550-600-700-800 SureSigns Vsi, VS2+ SureSigns VM4-6-8 and VS3-VS4-VSV series
45763	C	Philips	MIST and UltraMIST series
45764	D	Sanuwave	S and M series
45764	D	Sonosite	S and M series

# DOUBLE FACE PHARMACY TROLLEY



• **27499 DOUBLE FACE PHARMACY TROLLEY** - 3 large, 30 small drawers  
Two trolleys in one: 3 large drawers on one side, 30 (6+9+15) monodose cassettes on other side; with locking system.

Size of cassettes:

- 6 cassettes 115x290xh 75 mm
- 9 cassettes 115x290xh 45 mm
- 15 cassettes 70x290xh 45 mm

Size of trolley: 920x590xh 810 mm

Provided with 4 revolving castors Ø 125 mm (3 with brake, 1 of trolley, antistatic).



• **45730 DOUBLE FACE PHARMACY TROLLEY** - 3 large, 22 small drawers  
Two trolleys in one: 3 large drawers on one side, 22 (6+6+10) monodose cassettes on other side; with locking system.

Size of cassettes:

- 6 cassettes 115x290xh 75 mm
- 10 cassettes 115x290xh 45 mm

Size of trolley: 920x590xh 810 mm

Provided with 4 revolving castors Ø 125 mm (3 with brake, 1 of trolley, antistatic).



• **45731 DOUBLE FACE PHARMACY TROLLEY** - 62 small drawers  
Two trolleys in one: 31 (6+10+15) monodose cassettes on both sides; with locking system.

Size of cassettes:

- 6 cassettes 115x290xh 75 mm
- 10 cassettes 115x290xh 45 mm
- 15 cassettes 70x290xh 45 mm

Size of trolley: 920x590xh 810 mm

Provided with 4 revolving castors Ø 125 mm (3 with brake, 1 of trolley, antistatic).



## EXCEL TROLLEY

Multilingual instructions: GB, FR, IT, ES, PT, DE, GR.



• **27440 EXCEL TROLLEY** - 3 shelves (60x45cm) Size: 67x69xh 80 cm.  
• **27441 EXCEL TROLLEY** - 4 shelves (60x45cm) Size: 67x69xh 110 cm.  
Maximum load: 80kg  
Delivered in kit form.

## TRIS TROLLEY



• **27438 TRIS TROLLEY**  
A practical trolley for ECG, Electrosurgical unit or any other device, with 4 nylon castors and 2 lateral handles for easy moving.  
Size: 49x37xh 77 cm. Shelf size: 40x30 cm.  
Total load: 39 kg, max per shelf 13 kg  
Colour: RAL 9002  
Multilingual manual: GB, FR, IT, ES, PT, DE.  
Delivered in kit form.

## PROFESSIONAL CARTS



• **27885 PRO CART 2 shelves - h 80 cm**  
• **27887 PRO CART 2 shelves + keyboard and monitor support**  
• **27873 BASKET**  
• **27874 INFUSION STAND**

### TECHNICAL SPECIFICATIONS

Load capacity: - total load 240kg - shelf 35kg  
Base: 60.8x50 cm  
Shelves: 2 shelves 50x50 cm + base  
Material: - vertical extrusions in aluminium  
- plastic parts in ABS

## DRUGS & MEDICINE TROLLEYS



27495



27497



27494

- 27494 PHARMACY TROLLEY - small - 67x64xh 100 cm with 15 3-compartment partition
- 27495 PHARMACY-TROLLEY - standard - 82x64xh 100 cm with 20 3-compartment partition
- 27497 PHARMACY TROLLEY - large - 115x64xh 100 cm with 30 3-compartment partition

A portable pharmacy, allowing to manage daily or weekly treatment of patients, with 15/20/30 3 compartments small drawers for easy drug storage (45-60-90 spaces).

Painted steel frame, technopolimer surface and panels. Can be completely closed by safety key lock.

Provided with 4 revolving castors Ø 125 (2 with brake).

- 27498 PARTITION - 3 compartments - spare



27498

4 x 27498

MADE IN ITALY

## DRUGS & MEDICINE CABINETS



27942, 27944

MADE IN ITALY



27941



**MEDICINE CABINETS 100x60xh 195 cm**  
**With drugs compartment, 60 medicine compartments and 5 adjustable shelves**  
 - made of bilaminated board (27944/5) or melamine board (27942) 20 mm thick  
 - epoxy powder painted steel base frame with 4 adjustable feet Ø 50 mm  
 - 2 external lockable doors turning through 180° with 10 medicine compartments each  
 - perimetrical anti-dust gaskets  
 - inside 2 containers with 10 medicine compartments each side turning through 90°  
 - dangerous drugs compartment 40x22x40 cm provided with lock



• 27941 COMBO MEDICINE CABINETS 96x66xh 195 cm with 30 medicine compartments one side and 6 ISO trays 1 shelf and 3 drawers other side  
 - made of bilaminated board 20 mm thick  
 - epoxy powder painted steel base frame with 4 adjustable feet Ø 50 mm  
**Right side**  
 - 1 external lockable door turning through 180° with 10 medicine compartments each  
 - perimetrical anti-dust gaskets  
 - inside 1 container with 10 medicine compartments each side, turning through 90°, provided with lock  
**Left side**  
 - glass door, internal side, with runners for ISO trays  
 - 3 drawers on the bottom  
 Supplied with 6 ISO trays different heights (2xh 5 cm, 3xh 10 cm and 1xh 20 cm) and 1 shelf.

GIMA code	MEDICINE CABINET	Material	Colour						
27942	Medicine cabinet	melamine particle board	white						
27944	Medicine cabinet	bi-laminated board	white						
27945	Medicine cabinet	bi-laminated board	any colour*						
Colours:	412	431	441	482	484	499	854	861	1818

\*You have to indicate requested colour with order. Available in 30 days

## BAG HOLDER TROLLEYS



45904+45910

MADE IN ITALY

- 45904 BAG HOLDER TROLLEY - 1 bag
  - 45905 BAG HOLDER TROLLEY - 2 bags
  - 45906 BAG HOLDER TROLLEY - 3 bags
- Bag holder trolleys with pedal operated opening. Rigid, sturdy, self-supporting ABS plastic base with edges. The bag holding ring (35x25.5 cm) is made of glass reinforced nylon with a rubber gasket to hold the bag in place. Two vertical tubes made of AISI 304 stainless steel are welded to the base and carry the bag holding ring.



45905+45910

MADE IN ITALY

- Non marking grey rubber swivelling wheels Ø 80 mm (two with pedal operated brake). Pedal system equipped with shock absorber for silent lid closure.
- 45910 PUSH HANDLE
  - 27466 WRAPPING BAG - yellow strip
  - 27462 WRAPPING BAG - blue strip
  - 45908 WRAPPING BAG - green strip
- White synthetic bag with strip, washable up to 200 times. Size 57xh 103 cm.



45906+45910

MADE IN ITALY



45905+27462+27466+45910

## LAUNDRY TROLLEY



45913

- 45913 LAUNDRY TROLLEY
- Laundry trolley with stainless steel structure. Canvas bag and three shelves. Silent and antistatic castors Ø 7.5 cm with brake assembled on the vertical column line for better stability. Size 900x450xh 1050 mm. Supplied with canvas bag.
- 45914 CANVAS BAG - spare



Noiseless castors with brake



Velcro for canvas bag

## SHUT BAG HOLDER



45900

MADE IN ITALY

- 45900 SHUT BAG HOLDER - 70 l
- Trolley suitable for carrying one 70 l bag (not included). Stainless steel AISI 304 structure. Equipped with swivelling castors with brake and bumpers. For use with standard 70 l plastic bag. Can use also wrapping bag (27462, 27466, 45908)

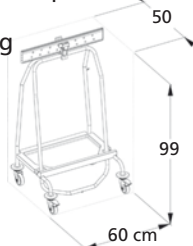

## LINEN TROLLEYS



27467

- 27467 SOILED LINEN TROLLEY
  - 27468 DOUBLE SOILED LINEN TROLLEY
- Chrome plated frame with 3 or 4 castors Ø 80 mm. Removable bag. Size: Ø 46xh 90 cm. Delivered in kit form.



27468

Size: 92x90 cm

## LAUNDRY TROLLEYS



MADE IN ITALY

27465 + 27462 + 27466

Wrapping bag not included

MADE IN ITALY

45926 + 27462 + 27466

MADE IN ITALY

45915

• 27464 LAUNDRY TROLLEY - painted steel

• 27465 LAUNDRY TROLLEY - stainless steel

Trolleys to collect dirty laundry while distributing clean linen to the patient. Stainless steel or painted steel frame. Equipped with 4 Ø 125 mm castors (2 with brake) and 4 rubber bumpers at corners. Size: 135x65xh 102 cm.

• 27463 SIDE PANEL - stainless steel

• 27466 WRAPPING BAG - yellow strip

• 27462 WRAPPING BAG - blue strip washable up to 200 times, 57xh 103 cm



27464+27462

27465+27462+27463

• 45925 CLOSED LAUNDRY TROLLEY - painted steel

• 45926 CLOSED LAUNDRY TROLLEY - stainless steel

Trolleys for collection of dirty laundry and distribution of clean linen to the patient. Stainless steel or painted steel frame. Equipped with 4 Ø 125 mm anti-thread swivelling castors (2 with brake), 2 rectangular supports with rubber bag stop ring, 2 lids and 3 shelves of which 2 adjustable.

Suitable for 70 litres waste bags.

Size: 1330x650xh 1200 mm (45925)

1330x650xh 1140 mm (45926)

• 27466 WRAPPING BAG - yellow strip

• 27462 WRAPPING BAG - blue strip

White washable laundry synthetic bag with yellow or blue strip.

Size: 57xh 103 cm.

• 45915 LAUNDRY TROLLEY - laminated Closed trolley with doors, 3 shelves plus top and 2 bag holders.

Laminated particle board body and stainless steel AISI 304 structure. Equipped with swivelling castors, 2 with brake and bumpers.

Size: 110x66x132 cm.

• 27462 WRAPPING BAG - blue strip

• 27466 WRAPPING BAG - yellow strip

White washable laundry synthetic bag with yellow or blue strip.

Size: 57xh 103 cm.



## CLEAN LINEN AND PATIENT HYGIENE TROLLEYS



45930

45931

45933

45934

MADE IN ITALY

### CLEAN LINEN TROLLEYS 2 DOORS

Solid and sturdy trolleys for distribution of clean linen and patient hygiene. Steel painted with antimicrobial epoxy powders to obtain maximum lightness. Upper part has large support surface in technopolymer plastic material. Integrated ergonomic push handle. Supplied with 2 doors with 3 internal shelves (45930, 45933 only) or 2 doors with 2 internal shelves and one drawer made of antimicrobial epoxy powder coated steel (45931, 45934 only). Key closures.

4 castors Ø 125 mm, anti-wire, pivoting, two of which with lever locking system and reinforced plastic support.

GIMA code	CLEAN LINEN TROLLEYS	Size (mm)	Drawer size (mm)
45930	Clean linen trolley - small	670x640xh 1280	-
45931	Clean linen trolley - small	670x640xh 1280	600x480xh 150
45933	Clean linen trolley - standard	820x640xh 1280	-
45934	Clean linen trolley - standard	820x640xh 1280	750x480xh 150

# ISO SERVICE TROLLEYS



Size: 65x47xh 100 cm  
Weight: 12.5 kg

Pivoting castors  
Ø 100 mm  
(2 with brake)

**27935**  
MADE IN ITALY



Size: 59x99.3xh 88 cm  
Adaptable to any model of ISO 600x400 baskets and trays thanks to the special rail sides, which allow an easy sliding and pull out.

**27934**

4 wheels Ø 125 mm  
(3 with brake)

Lockable with double key

**27936**

Equipped with key lock and doors kit made of transparent polycarbonate.

Side plastic runners for "ISO" trays or baskets

**27936**  
(baskets and trays not included)

Handle for transport



27924  
27938  
27938  
27938  
27939

Antistatic castors  
Ø 125 mm (2 with brake)

• **27935 ISO SERVICE TROLLEY - empty**

Service trolley for "ISO" trays or baskets (not included) made of epoxy powder painted steel. Supplied with 5 height adjustable runners for ISO trays/baskets.



Both side basket pulling out with stopper to avoid accidental fall.

• **27934 AURION MINI 600 - ISO trolley - empty**

Basic body made of Baydur Polyurethane - Bayer AG: it can be washed and disinfected. It does not react with diluted acids, alkali and solvents. Self-extinguishing according to class UL V0 - Latex Free. For safety, handles are moulded into the body on both sides, trolley top has a 4-sided moulded containing rim to avoid any spill or fall of materials. No sharp edges. All around bumper. Lightweight and easy to move.

• **27936 ISO TRANSPORT TROLLEY - empty**

Transport trolley for ISO trays and baskets (not included). Made of stainless steel AISI 304 sheet, scotch brite finishing. Anti-dust gasket. Internal side with plastic runners for ISO trays or baskets. Supplied with handle for transport. External size: 52x68xh 159 cm Internal size: 40x60xh 129 cm

# ISO FORMAT UNIVERSAL MODULAR TRAY SYSTEM

27996

ISO MODULAR TRAYS GREY ABS		
Closed	Open	SIZE mm
27924	-	600x400x50
27925	27938	600x400x100
27928	27939	600x400x200
TRANSPARENT PC		
Closed	Open	SIZE mm
27957	-	600x400x50
27958	27965	600x400x100
-	27966	600x400x200

Intelligent solutions for storing all kind of drugs, bandages, accessories and small components in a space saving and clear manner.

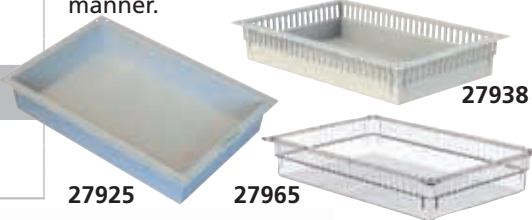

27925 27965 27938

GIMA code	DIVIDERS
27994	400x50 mm
27995	600x50 mm
27996	400x100 mm
27997	600x100 mm
27998	400x200 mm
27999	600x200 mm
28001	Drawer stopper

# NEO EMERGENCY TROLLEY

• **45722 NEO EMERGENCY TROLLEY**

Heavy duty construction emergency trolley size 75x47.5x92 cm with five drawers. Four castors (Ø 10 cm) assembled on the vertical column line for better stability. One piece counter top with a fully guarded handle for comfort and protection.



Not included

Panel height 8 cm  
Inner: 43.x33.5x6.8 cm  
Panel height 12 cm  
Inner: 43.x33.5x11 cm

- STANDARD ACCESSORIES**
- Defibrillator plate
  - Sliding side shelf
  - Sharp container
  - Oxygen bottle holder
  - Power outlet
  - Utility container
  - IV pole
  - CPR board
  - 2 waste bins
  - Dividers
  - Central lock



**45722**

Panel height 24 cm  
Inner: 43x33.5x22 cm

# NEO MEDICINE TROLLEY

• **45725 NEO MEDICINE TROLLEY - double side**

Two sided medicine trolley 75x48x92 cm with steel and aluminium structure inside, ABS and antibacterial material outside. 4 nylon castors Ø 12.5 cm, one with brake.



Central locking

Aluminium alloy handle

10 drawers (5 per side) with dividers to create up to 20 compartments per drawer



1 large drawer with 12 compartments

**45725**

- STANDARD ACCESSORIES**
- Central lock
  - 2 waste bin
  - Utility container
  - 4 covered castors
  - Dividers



# EMERGENCY TROLLEYS - PAINTED OR STAINLESS STEEL

## EMERGENCY TROLLEYS

Professional, solid and sturdy emergency trolleys with components in plastic material (technopolymer) or stainless-steel sheet painted with epoxy powders to obtain maximum lightness, maneuverability and ease of use. Self-supporting and monocoque structure.

Upper part has large support surface in technopolymer plastic material to facilitate cleaning and disinfection. Ergonomic push handle firmly attached on the right side of the trolley.

Front part designed for insertion of modular drawers: silent sliding of the drawers on guides with ball bearings, equipped with limit stops and designed for central locking with key. Defibrillator plate has a plexiglass plate and tubular support in stainless steel, 360° rotatable and lockable every 10°, device can be locked by means of straps that can be adapted to any size.

Stainless steel IV stand adjustable in height with locking device. Heart massage plate made of transparent plexiglass.

Four or five standard drawers entirely made of AISI 304 stainless steel (45695-6) or plastic material (27479, 27482, 45693-4).

Additional extractable worktop in technopolymer plastic material on the left side; built-in compartment complete with four shelves with front panel all made of technopolymer plastic material.

4 castors Ø 125 mm, anti-thread, pivoting of which 2 antistatic and 2 with locking system with lever, wheel and fork on ball bearings.



GIMA code	EMERGENCY TROLLEYS	Trolley size (cm)	Number of drawers	Drawers material	GIMA code	ACCESSORIES
27479	Painted steel emergency trolley - small	67x64xh 100-160	4	plastic	27471	Divider kit for 27479 (drawer 45 cm)
27482	Painted steel emergency trolley - standard	82x64xh 100-160	4	plastic	27472	Divider kit for 27482 (drawer 60 cm)
45693	Painted steel emergency trolley - small	67x64xh 100-160	5	plastic	27485	Disposable numbered seals - box of 100
45694	Painted steel emergency trolley - standard	82x64xh 100-160	5	plastic	27474	Premium disposable numbered seals - box of 100
45695	Stainless steel emergency trolley - small	67x64xh 100-160	5	stainless steel		
45696	Stainless steel emergency trolley - standard	82x64xh 100-160	5	stainless steel		

TECHNICAL SPECIFICATIONS						
	27479	27482	45693	45694	45695	45696
Drawers number/size:	3 45x48.5xh 13.5 cm 1 45x48.5x h 27.5 cm	3 60x47.5xh 13.7 cm 1 60x47.5xh 27.4 cm	2 45x48.5xh 7.5 cm 2 45x48.5xh 15 cm 1 45x48.5xh 22.5 cm	2 60x47.5xh 7.5 cm 2 60x47.5xh 15 cm 1 60x47.5xh 22.5 cm	2 45x48.5xh 7.5 cm 2 45x48.5xh 15 cm 1 45x48.5xh 22.5 cm	2 60x47.5xh 7.5 cm 2 60x47.5xh 15 cm 1 60x47.5xh 22.5 cm
Defibrillator plate:	39x32xh 2 cm					
Size (cm):	67x64xh 100-160	82x64xh 100-160	67x64xh 100-160	82x64xh 100-160	67x64xh 100-160	82x64xh 100-160

STANDARD ACCESSORIES	
<b>Right side</b> Waste container Catheter or probes holder Shelf with front panel Recessed compartment	<b>Left side</b> Extractable worktop Compartment with 4 shelves and front panel
<b>Upper part</b> IV stand Defibrillator tray	<b>Rear side</b> Built-in gas bottle compartment with fastening straps Bar with hooks for accessories



# MULTI-FUNCTIONAL TROLLEYS: BASIC AND DRESSING

## MULTIFUNCTIONAL TROLLEYS: BASIC - DRESSING

These multifunctional professional trolleys have painted steel structure and external plastic finishing. Basic and Dressing are available in 3 different sizes (small, standard, medium). Provided with 4, 8 or 9 drawers, one lateral waste container (manual opening, capacity 15 l) and one extra lateral table. Four swivelling rubber castors Ø 125 mm (2 with brake).

### BASIC



45702 Standard



27476 Standard



27477 Small

### DRESSING



27481 Standard



45701 Small



27484 Medium

### BASIC TROLLEY - 3 sizes

Standard version without accessories

**DIVIDER KIT** - size: 20/35/50x43xh 7 cm

- 27470 KIT for drawer 30 cm - 8 compartments
- 27471 KIT for drawer 45 cm - 20 compartments
- 27472 KIT for drawer 60 cm - 25 compartments



Partitions are removable

MADE IN ITALY

### DRESSING TROLLEY - 3 sizes

Same as Basic, but equipped with instrument tray and upper dispenser (10 tilting bins).

BASIC		DRESSING		Size Type	Size of trolley (cm) (without accessories)	Number of drawers	Size of drawers cm					
Yellow	Blue	Yellow	Blue				45x48xh13	45x48xh27	60x48xh13	60x48xh27	30x48xh13	30x48xh27
27477	45700	27478	45701	Small	67x64xh 100	4	3	1	-	-	-	-
27480	45702	27481	45703	Standard	82x64xh 100	4	-	-	3	1	-	-
27476	45704	-	-	Standard	82x64xh 100	9	-	-	-	-	8	1
27483	-	27484	-	Medium	102x64xh 100	8	3	1	-	-	3	1
27486	-	-	-	Large	115x64xh 100	8	-	-	3	1	3	1

# RECORD HOLDERS AND X-RAY FILM HOLDERS TROLLEYS

For 25+25 file racks (not included)

Keeps 25 file racks (not included)

MADE IN ITALY

Keeps 40 file racks (not included)

Sliding up



27492



27491



27490



27488

- 27490 RECORD HOLDERS TROLLEY - sliding top
  - 27491 RECORD HOLDERS TROLLEY
  - 27492 RECORD HOLDERS TROLLEY - 2 large drawers
- Record trolleys are designed to hold clinical reports in A3/ A4 format or specific format. Frame in epoxy painted steel, working surface and panels in technopolimer plastic. Equipped with 4 Ø 125 mm swivelling rubber castors (2 with brake). Bumpers around the perimeter. Size: 820x640xh 1,000 mm (code 27491 and 27490) 820x640xh 1,150 mm (code 27492).
- 27493 FILE RACK A3 465x390 mm plastic



27493

- 27488 X-RAY FILM HOLDER
- This trolley has 32 extractable compartments, a wide top surface, 4 side document holders, and a sliding out writing surface. Frame is in painted steel with sliding-in bilaminated doors with a 270° opening. Base and lateral cabinets are made of technopolimer material. Equipped with 4 Ø 125 mm swivelling rubber castors (2 with brake). Size 820x640xh 1, 200 mm.

## MULTIFUNCTIONAL TROLLEYS WITH CENTRAL BREAKING SYSTEM

• **45711 MULTIFUNCTIONAL TROLLEY 65x88xh 100 cm**

• **45713 DRESSING TROLLEY 65x88xh 100 cm with dispenser**

Solid and robust construction with steel sheet painted with antimicrobial epoxy powders and technopolymers for maximum lightness, maneuverability and ease of use.

**Upper part:** large support surface in PST with ergonomic and integrated push handle. Push handle has a central mechanism for locking and unlocking wheels' brakes.

**Front part:** retractable worktop support with "push and pull" opening.

Four modular drawers with soft self-closure, ball bearings and central locking with key. Drawers are made of painted steel.

**Left side:** recessed compartment and retractable worktop made of technopolymer plastic; 10 L waste bin with knee opening and technopolymer catheter holder.

**Right side:** recessed compartment with three tilting pockets made of technopolymer material.

Supplied with four Ø 100 mm twinned castors with automatic locking system.



Left side



Central breaking system



MADE IN ITALY

45711

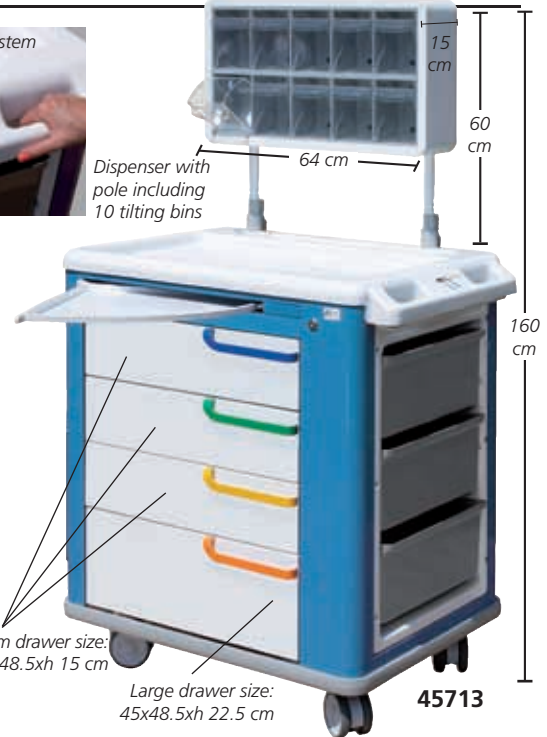

Dispenser with pole including 10 tilting bins

Medium drawer size: 45x48.5xh 15 cm

Large drawer size: 45x48.5xh 22.5 cm

45713

## KS MULTIFUNCTIONAL TROLLEYS

**MULTIFUNCTIONAL TROLLEYS: BASIC, DRESSING, EMERGENCY**

Professional trolleys in 2 sizes (small and standard) and 3 models (Basic, Dressing and Emergency).

- antimicrobial epoxy painted body with seal lock (Emergency) or key lock (Basic and Dressing)
- top surface with 4-sided rim
- top surface with built-in compartment

- ball-bearing full-extension sliding drawer with self-closing system
- built-in handle
- 4 swivelling castors Ø 125 mm - 2 antistatic (only 45688/9) and with brake
- lateral waste container 15 l with lid and catheter holder (Dressing and Basic only)
- size: small 760x714xh 1,022 mm standard 911x704xh 1,075 mm

MADE IN ITALY



Lateral side with waste container 15 l with lid and catheter holder

45680



Dispenser with pole including 10 tilting bins

45685



Back with large oxygen tank compartment and stainless steel holding rail with hooks

Lateral side with waste containers 15 l with lid

45689



45681

2 small drawers: 600xh 75 mm  
2 medium drawers: 600xh 151 mm  
1 large drawer: 600xh 228 mm

Writing surface

Lateral container unit with 4 supply trays



45684

3 medium drawers: 450xh 151 mm  
1 large drawer: 450xh 228 mm

Writing surface

Lateral container unit with 4 supply trays



45689

Height adjustable I.V. pole with 2 hooks  
Defibrillator/monitor rotating tray

2 small drawers: 600xh 75 mm  
2 medium drawers: 600xh 151 mm  
1 large drawer: 600xh 228 mm

- 45680 BASIC TROLLEY - small
- 45681 BASIC TROLLEY - standard

- 45684 DRESSING TROLLEY - small
- 45685 DRESSING TROLLEY - standard  
Dressing trolley is supplied with upper dispenser (10 tilting bins).

- 45688 EMERGENCY TROLLEY - small
- 45689 EMERGENCY TROLLEY - standard  
Emergency trolley is supplied with rotating defibrillator/monitor tray, height adjustable I.V. pole with 2 hooks.

# AURION MULTIFUNCTIONAL TROLLEYS - TOP QUALITY

## AURION TROLLEYS

A multifunctional and revolutionary line of carts with innovative design, superior quality and complete accessories.

### Made in Baydur® polyurethane

Baydur® Polyurethane is a high performance material that combines the best characteristics of plastics and metals. Light, sturdy, high resistance to scratching and impact. Resistant to UV rays. Chemical inert, doesn't react to acids, organic and inorganic, alkali and solvents (DIN 68861/1).

Fire resistant, self-extinguishing (Class I, UL94 V-O). Non-toxic, in case of combustion it doesn't produce dioxin.

### Well-designed

The Aurion trolleys are ergonomic, modular, highly customizable and upgradable over the years. The handles are moulded and integrated into the body as well as the worktop that has large surface and perimetrical anti-drip containing rim. Every drawer is equipped with a label holder.

### Easy to move

Lightweight structure combined with the high quality non-marking and anti corrosion castors. Every wheel is mounted on ball bearings with sealed lubrication (2 per wheel), 3 with brake, 1 antistatic.

### Hygienic and safe

The smoothly shaped design, without edges, guarantees safety to the user and avoids dirty and bacterial accumulation points. Easy to clean and disinfect also with aggressive detergents.

### Safe and secure

All-around soft rubber bumper help to avoid damages to hospital staff, patients, objects or to the trolley itself.

Centralized locking device with key (45740-45746) or with seal (45750-45751).

Size 775x710xh 920 mm

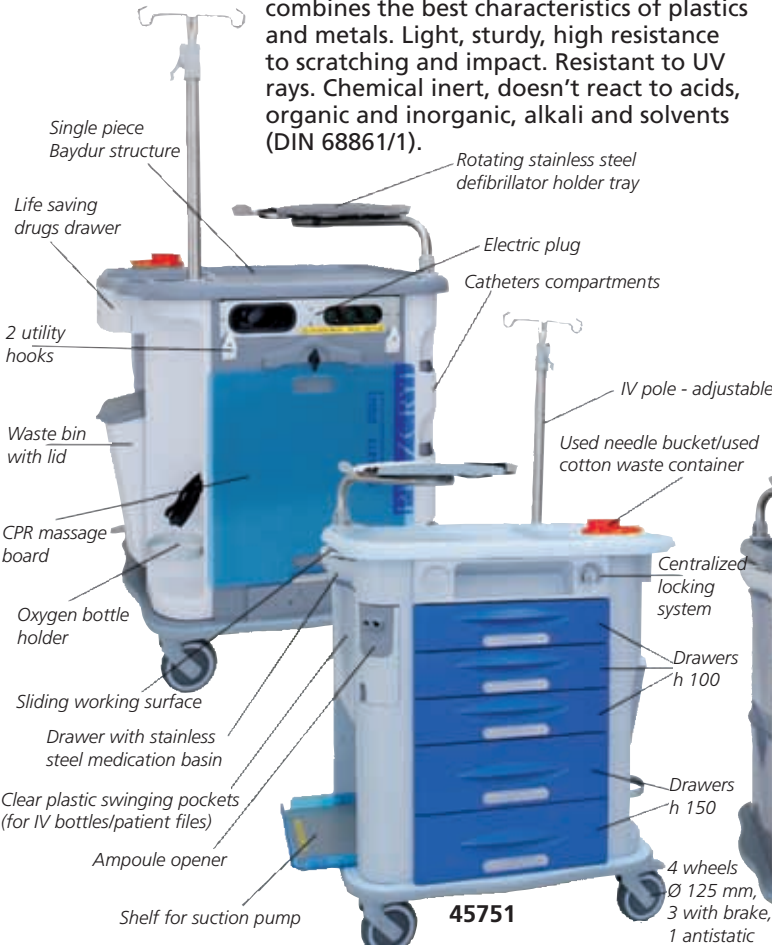

- 45751 AURION EMERGENCY TROLLEY - dark blue - 5 drawers
- 45750 AURION EMERGENCY TROLLEY - red - 4 drawers with IV stand, defibrillator tray, suction unit shelf (45751 only), CPR massage board, electric plug (45751 only).



- 45755 AURION AMAGNETIC TROLLEY - yellow - 5 drawers with amagnetic wheels, without locking system



- 45740 AURION THERAPY TROLLEY - green - 4 drawers
- 45741 AURION THERAPY TROLLEY - light blue - 5 drawers with IV stand (45751 only), upper drawers, bin (45741 only)
- 45744 AURION DRESSING TROLLEY - blue - 5 drawers
- 45746 AURION MONODOSE TROLLEY - brown - 2 drawers + 2 monodose cassettes (10 small drawers each)

# MULTIFUNCTIONAL AND EMERGENCY KARTS

## MULTIFUNCTIONAL KARTS

High quality aluminium multifunctional and emergency carts with superior features.

- work-top in high performance copolymer, with perimetric edge for liquid containment
- extruded aluminium frame, with superficial silver antioxidant treatment offering more lightness, resistance and reliability
- ergonomic stainless steel handles, fitted on both sides for easy handling
- drawer structure built in steel sheets, epoxy powder coated
- full pull-out sliding drawers

- interchangeable drawer position
- aluminium drawer handle with "hook/unhook" system to prevent accidental opening of drawers



- 45660 COMPACT KART - 5 drawers - blue  
Size: 654x605xh 975 mm
- 45661 UPPER DRAWERS (9+5) - blue for 45660
- 45662 MEDIUM KART - 5 drawers - blue  
Size: 804x616xh 975 mm
- 45663 UPPER DRAWERS\* (9+5) - blue for 45662

\*Included support for glove box

- 45677 PARTITION KIT for compact kart drawers h2/h3



45677

- high drawers capacity: 20 kg (35 kg for drawer h-200-283 mm)
- centralized locking system with front key or single use seals (emergency karts only)
- 6 integrated side pockets (3+3) to hold bottles or small items
- swivelling wheels Ø 125 mm (two with brake) in thermoplastic rubber with threadguards, hub on precision ball bearings.

### TECHNICAL SPECIFICATIONS

Frame size:	COMPACT: 654x605xh 975 mm	MEDIUM: 804x616xh 975 mm
Drawer size Compact/Medium:	Front width/height	Inner sizes
small	h1= 1/10 490/640xh 64 mm	432/582x448xh 58 mm
medium	h2= 2/10 490/640xh 137 mm	432/582x448xh 131 mm
large	h3= 3/10 490/640xh 210 mm	432/582x448xh 204 mm
folder holders	h4= 4/10 490/640xh 283 mm	432/582x448xh 270 mm



- 45665 EMERGENCY COMPACT KART - 5 drawers - red
- 45666 EMERGENCY COMPACT KART - 4 drawers - orange  
Size: 654x605xh 975 mm
- 45667 EMERGENCY MEDIUM KART - 5 drawers - red
- 45668 EMERGENCY MEDIUM KART - 4 drawers - orange  
Size: 804x616xh 975 mm

Supplied with infusion stand holder 4 hooks, Ø 120-150 mm defibrillator holder tray, cylinder holder (double for 45667/8) and CPR board (only 45666/8).

- 27485 DISPOSABLE NUMBERED SEALS - box of 100
- 27474 PREMIUM DISPOSABLE NUMBERED SEALS - box of 100 45666



Slim LED X-ray illuminator viewing area 42x36 cm. See other specifications at page 184, code 44700.

- 45671 VIEWER KART  
Compact kart with slim LED viewer, 2 small drawers and 2 folder holders.
- 45678 HANGING FILE FOLDERS\*

- 45672 VIEWER KART 2  
Compact kart with slim LED viewer, 2 small and 1 medium drawers, 10 compartments for folders (44x48xh 43,8 cm).

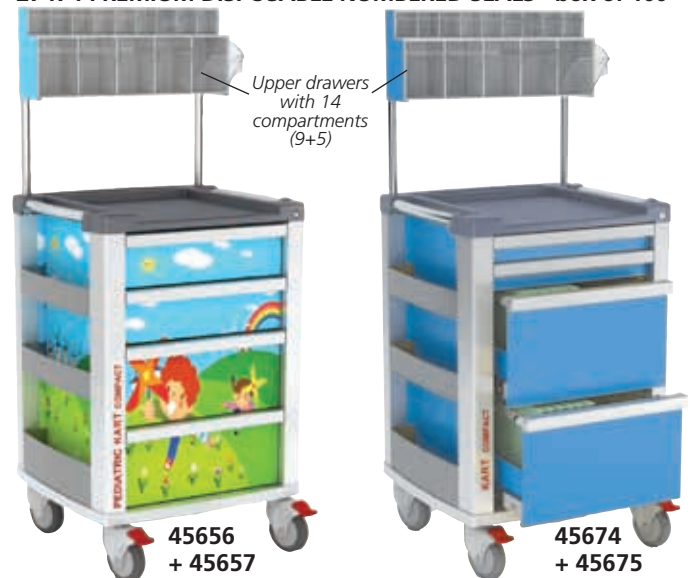

- 45656 PEDIATRIC KART  
Pediatric compact kart with 2 medium and 2 large drawers.
- 45657 UPPER DRAWERS (9+5)

- 45674 MULTIPURPOSE KART  
Compact kart with 2 small drawers and 2 folder holders.
- 45675 UPPER DRAWERS (9+5)
- 45678 HANGING FILE FOLDERS\*

• 45650 PERSONALIZED KART: CONFIGURATE YOUR KART SELECTING COLOUR, DRAWERS AND MODEL - available in 45 days

Available drawers	Small 1/10 h	Medium 2/10 h	Large 3/10 h	Folder holder 4/10 h	You can choose your drawers considering:		
Available colours	Red RAL3020	Orange RAL2004	Turquoise RAL5018	Blue RAL5010	Ceil blue RAL5012	Green RAL6018	Yellow RAL1021

\* Box of 25 hanging file folders 365 x 240 mm

# PAINTED OR STAINLESS STEEL MODULAR TROLLEYS SYSTEM



## MODULAR TROLLEYS SYSTEM

Modular trolleys made of painted steel or stainless steel, one-piece structure, with wide technopolymer plastic worktop with borders on 3 sides to be cleaned easily, no sharp corners, ergonomic tubular push-handle. Different drawers (small-yellow, medium-blue, large-red), depending on model, with epoxy painted panels and

integrated handle grip, silent sliding with end-run block. Possibility to remove the drawers for the guides for an easy cleaning and disinfection. Central lock key. Overall bumpers and 4 antistatic 125 mm castors, 2 with brakes. Size: 67x63x104 cm. Weight: 53 kg. Personalization for minimum 10 pcs: drawers in your colour.

Painted	Stainless steel	TROLLEYS
45600	45620	Trolley with 7 small drawers
45601	45621	Trolley with 1 small, 3 medium drawers
45602	45622	Trolley with 2 small, 1 medium, 1 large drawers
45603	45623	Trolley with 1 small drawer, 1 compartment with shelf
45604	45624	Trolley with 2 medium, 1 large drawer



### ACCESSORIES FOR ALL MODULAR SYSTEM TROLLEYS

45640	IV stand
45641	Upper drawers (5 medium + 4 large)
45644	Partition h 4 cm for yellow drawer (49x48x10 cm)
45645	Partition h 14 cm for blue drawer (49x48x20 cm)
45646	Partition h 20 cm for red drawer (49x48x30 cm)

## WASH-BASIN - PUMP

### 45410 WASH-BASIN PUMP SYSTEM - white

Automatic wash-basin with round bowl in satin stainless steel, non-connected to the water mains. The system ensures the availability of water when it is expensive or impossible to lay drain-pipes in the walls or floors.



Dimensions:  
47x54xh 86 cm

It only requires a 230V power socket: the low voltage transformer (12V) drives a pump for supplying water by a simple pressure of the foot on the base.

Equipped with 2x20 litre tanks for water supply and drain

## UTILITY TROLLEY



45595

Blue Avio  
RAL 5014  
available in stock

MADE IN ITALY

### 45595 UTILITY TROLLEY - blue avio 45597 UTILITY TROLLEY - other colours\*

RAL 5010	RAL 2003	RAL 6019	RAL 1013	RAL 3020
----------	----------	----------	----------	----------

\*Available in 30 days. Minimum order 5 pcs.

Smart and strong steel structure painted with epoxy powder. Technopolymer plastic one-piece top with border, without sharp corners, with compartment for accessories. Ergonomic push handle. 3 medium drawers 45.1x48.5xh 15 cm and 1 large drawer 45x49.5xh 22.5 cm with silent sliding and end-run block. Central lock key. Size: 60x50xh 100 cm Overall bumpers and 4 antistatic 125 mm swivelling castors, 2 with brake.



45597 Utility trolleys other colours available in 30 days

## MULTI-PURPOSE WALL UNITS

Multi-purpose wall unit to organize dispensers of disposable products. All components and slots are modular and can be organized to match professional user needs. Available in 2 sizes: standard (103x20xh 40 cm) and large (153x20xh 40 cm) and 15 colours. Powder coated galvanized metal pull-up door with vertical opening. Supplied with automatic soap dispenser, cups dispenser and 5 (standard) or 7 (large) slots.

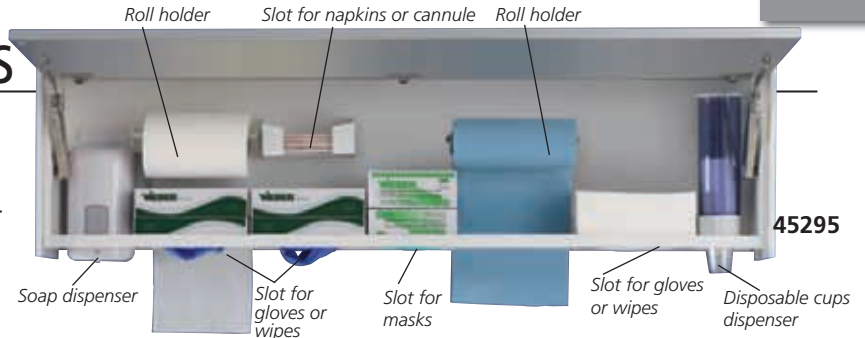

STANDARD ACCESSORIES	45290	45295
Dispenser for disposable cups	1	1
Automatic soap dispenser	1	1
Slot for gloves or wipes	2	3
Slot for masks	1	1
Slot for napkins or cannula	-	1
Roll holder	2	2

MULTIFUNCTIONAL WALL UNITS	
Model	white
Standard	45290
Large	45295

\*Available in 60 days, please specify colour with order

## GIMA MOBILE SPACE: WORKTOPS AND MOBILE UNITS

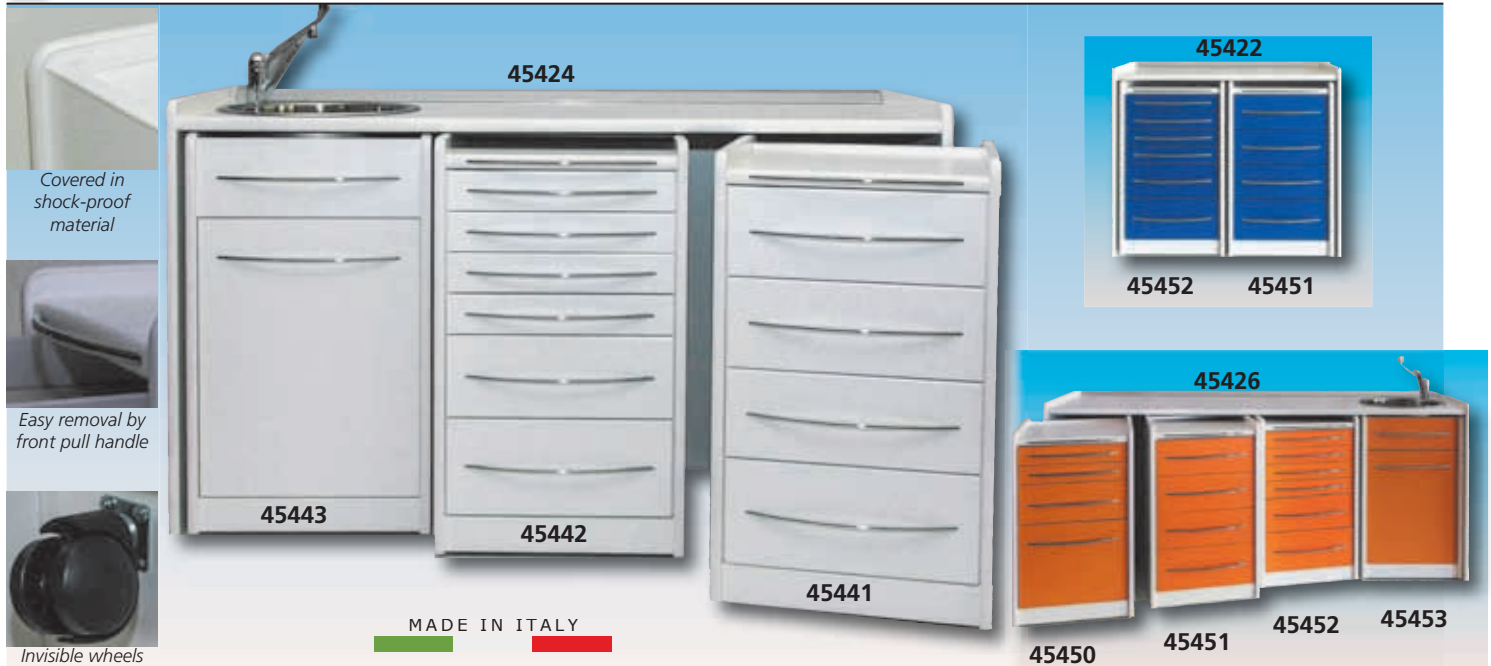

Mobile space is a programme of safe and ergonomic technical furniture for medical, physiotherapy and professional beauty use. These units feature wheels and offer the same levels of functionality as trolleys. The visible edges are radiating and covered in shockproof material. The steel handles provide good grip without dangerous edges. Stability is optimised by the inner and outer sides, the extra-thick backs and invisible wheel positioning. The steel runners of the drawers with rocker arm closing ensure smooth opening while preventing undesired opening during transport. The independent worktop makes it possible to fully pull out the units for easier floor cleaning and position the trolleys according to need. It is available with or without washbasin (left or right). The broad choice of unit configurations and colour range make it possible to personalise interiors according to individual requirements.



GIMA code	STANDARD WORKTOPS - WHITE
45420	Worktop 106 cm - right washbasin
45421	Worktop 106 cm - left washbasin
45422	Worktop 106 cm - without washbasin
45423	Worktop 156 cm - right washbasin
45424	Worktop 156 cm - left washbasin
45425	Worktop 156 cm - without washbasin
45426	Worktop 206 cm - right washbasin
45427	Worktop 206 cm - left washbasin
45428	Worktop 206 cm - without washbasin
<b>ACCESSORIES</b>	
45459	Chromed mixer tap

MOBILE UNITS				Model
white	blue	green	orange	
45440	←	45450*	→	4 drawers
45441	←	45451*	→	4 drawers
45442	←	45452*	→	6 drawers
45443	←	45453*	→	under washbasin

\*Available in 45 days, please specify colour with order

# 1 OR 3 ENGINES GYNAECOLOGICAL CHAIRS AND STOOLS

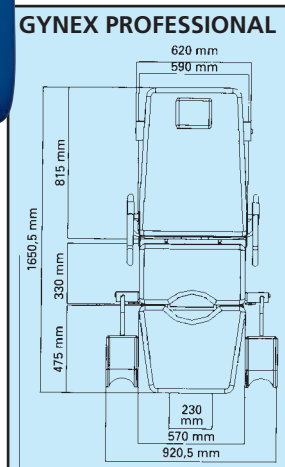
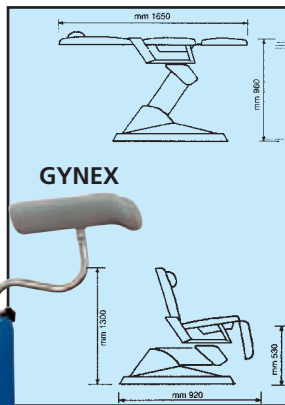

**GYNEX - GYNAECOLOGICAL CHAIR**  
 GYNEX: a chair offering a unique combination of functional, aesthetic and working characteristic.

Thanks to its self-balancing seat and backrest, GYNEX can be adjusted to any build for the greatest patient comfort. The chair is provided with an electromechanical lifting device, having a power supply at 24 V. The electric actuators enable the movement up and down from 57 cm off the floor ("0" position) up to a maximum of 96 cm. The backrest is supplied with adjustable headrest and paper roll holder. The legrest can be independently adjusted and it has an automatic-locking device.

The chair can be flattened to a bed position for examination activity, the armrest can be removed and independently oriented.

The electric control of the chair for upright position is operated by means of a foot pedal.

**GYNEX PROFESSIONAL - GYNAECOLOGICAL CHAIR**  
 Gynex professional chair offers functionality, aesthetics, ergonomics. It can satisfy all patient and user needs for a professional gynaecologic visit. Gynex professional is provided with versatile accessories: back paper-roll dispenser, metal basin, leg-supports. 3 engines allow, in addition to lifting, electric backrest and legrest movements. The combined movement of backrest and seat by means of self-balancing system (operated by a silent low tension actuator of 2,500 N) grants maximum comfort to the patient. The padded and pelted armrests allow a relaxing protecting sitting position, armrests are individually revolving and removable. Backrest is provided with removable height-adjustable headrest. The wide and soft backrest has independent adjustment movement through silent low tension actuator. This chair is moved by a silent low tension engine which allows a vertical excursion of 40 cm from zero position. The electrical drives are controlled by an ergonomic hand switch control, connected to the chair by a cable. Gynex professional can be easily transformed into an examination bed (horizontal position).

**TECHNICAL SPECIFICATIONS**

	GYNEX	GYNEX PROFESSIONAL
Power supply tension:	230V - 50 Hz (110V - 60 Hz on request)	
Motor tension:	24 V	24 V
Lifting motor push:	6,000 N	6,000 N
Backrest push:	800 N (gas spring)	2,500 N (motor)
Legrest motor push:	-	2,500 N
Lifting capacity:	180 kg	180 kg
Maximum power:	90 VA	90 VA
Fuses protection:	1.6 A	1.6 A

**GYNEX CHAIRS AND STOOLS**

	Light blue Parigi	Green Toronto	Blue Chicago	Orange Rotterdam	Metal Apricot	Metal Sea blue	Colour on request	
Gynex professional	27514	27512**	27513	27512**	27515	27512**	27512**	
Gynex	27521	27522	27523	27524	27525	27526	27520**	
Stool with ring	27531	27532	27533	27534	27535	27536	27530**	
Stool without ring	27527	← 27528** →						

\*\*Available in 60 days, specify colour with order

**COLOUR ON REQUEST: CLASSIC COLOURS**

White Helsinki	Beige Roma	Beige Tunisi	Brown Perugia	Yellow Parma	Orange Praga	Red Mosca	Pink Malaga	Bordeaux Bangkok
Green New Delhi	Green David	Green Melbourne	Green Irlanda	Green Honolulu	Green Caracas	Violet Nizza	Violet Ankara	Light blue Palm beach
Blue Berna	Blue Baltico	Blue Anversa	Grey Oslo	Grey Amburgo	Grey Londra	Black Odessa		

**COLOUR ON REQUEST: METALLIC COLOURS**

Metal Ice	Metal Silver	Metal Bronze	Metal Gold	Metal Lemon	Metal Red	Metal Sky Blue	Metal Blue	Metal Dust Grey
--------------	-----------------	-----------------	---------------	----------------	--------------	-------------------	---------------	--------------------



**STANDARD ACCESSORIES**

	GYNEX	GYNEX PROFESSIONAL
Polyurethane leg-rest	•	•
Padded leg-rest (colour coordinated)	•	•
Paper-roll holder	•	•
Basin	• (plastic)	• (metal)
Remote control	•	•

**STOOL - with or without ring**

For professional use, completely built in stainless steel, 360° pivoting self-braking castors, rubber-tyred. Height can be comfortably adjusted by means of a gas pump; back-rest is 180° revolving and depth-adjustable. Seat is balanced density padded and Peltex-lined. **MADE IN ITALY**

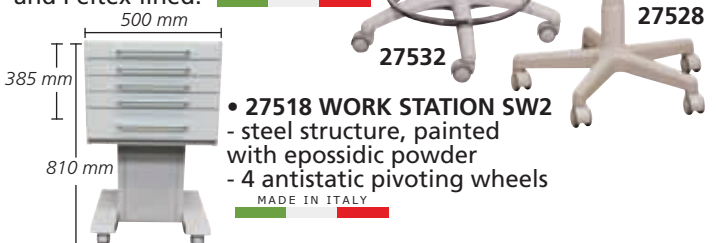



## GYNAECOLOGICAL AND DELIVERY BEDS



Size: 180x55xh 80 cm  
Seat size: 55x55 cm  
Delivered in kit form.

27501

Multilingual instructions:  
GB, FR, IT, ES, PT, DE, GR.

Standard leg holders



360° rotation

27503

Quality leg holders



360° rotation

27504

MADE IN ITALY



Size: 180x55xh 80 cm.  
Delivered in kit form.

27510

- 27500 DELUXE GYN BED - quality leg holders
  - 27501 GYNAECOLOGY BED - standard leg holders
- Strong chrome-plated structure. Rectangular steel tube. Adjustable head and leg sections. Simulated leather, black colour, washable upholstery, self extinguishing. Load: 110 kg. Complete with s/s bowl Ø 31 cm and leg-holders.
- 26586 S/S BOWL Ø 31 cm - spare

- 27510 DELUXE DELIVERY BED - quality leg holders
- Same as 27500, but with three sections with independent controls and Trendelenburg position. Load: 110 kg.
- 27503 STANDARD LEG HOLDERS - couple - spare
  - 27504 QUALITY LEG HOLDERS - couple - spare
- Kit leg holders includes 2 leg-holders and arms.
- 27418 COUCH ROLL HOLDER

## 3-SECTION MULTIFUNCTIONAL AND GYNAECOLOGICAL BEDS



LOAD 150 KG

27505

Adjustable standard leg holder, turnable 360° (27508)



27509

Seat: 50x60 cm

Size: 181x60xh 83 cm  
Delivered in kit form.

MADE IN ITALY

- 27502 3-SECTION MULTIFUNCTIONAL BED - blue
  - 27505 3-SECTION GYNAECOLOGICAL BED - blue
- Strong and stylish structure in oval tube 50x25 mm, painted with epoxy powder, metallic grey colour. The three sections top has high density padding, covered with washable, fire proof, leatherette material Class 1 IM. Back-rest and leg-rest section are fully adjustable by self mechanical system. Gynaecological bed is supplied with 2 foam padded leg holders and stainless steel bowl Ø 32 cm. Maximum load: 150 kg - Weight: 36 kg.



27502

Size: 185x60xh 85 cm

Delivered in kit form

Seat: 62x60 cm

- 27508 STANDARD LEG HOLDER for 27505 - couple - spare
  - 27509 QUALITY LEG HOLDER for 27505 - couple - optional
- Kit leg holder, includes 2 leg-holders and arms.
- 27511 COUCH ROLL HOLDER for 27502-5
  - 27919 DESK with 2 drawers - 130x71xh 80 cm
- Strong structure in oval tube 40x20 painted with epoxy powder, metal grey colour. White work top with rubber edge and round corner.
- 27979 FOOT STOOL - 2 steps



27919



27979



27538

## 3-SECTION DELIVERY BED WITH TRENDELENBURG

Height adjustable leg holder, turnable 360°

- 27538 3-SECTION DELIVERY BED - with Trendelenburg

- structure made of epoxy painted oval steel tube
- three sections with independent control and Trendelenburg position
- padding made of high density polyurethane foam, fireproof Class 1 IM
- covering made of washable, plastic material (leatherette) fireproof Class 1 IM
- adjustable rubber feet

Size: 181x60xh 80 cm  
Carton size: 75x20xh 196 cm.  
Maximum load: 150 kg.  
Net weight: 43 kg.

Supplied with a pair of height-adjustable, padded, anatomic leg-holders, a couple of shoulder rests, handgrips, a paper roll holder and a stainless steel basin Ø 32 cm. Delivered in kit form.

- 27509 QUALITY LEG HOLDER - couple - spare

MADE IN ITALY

## DONOR ARMCHAIR

- 27557 DONOR ARMCHAIR - blue - mechanical
  - 27563 DONOR ARMCHAIR - blue - electrical
  - 27567 DONOR ARMCHAIR WITH WHEELS - white
- Strong and stylish armchair with structure made of oval, round and square metal tubing fully coated with white epoxy powder (legs oval tubing 50x25x1.5 cm; central frame square tubing 30x30x1.5 cm, cushions round tubing 20xØ 1.5 cm). High density polyurethane foam platform with wooden base covered by leatherette upholstery. Flame resistant materials Class 1 IM. Synchronized adjustment of the two cushions by a gas spring, cylinder/piston, (27557, 27567) or by a linear actuator (27563) with a push-button panel, allow a quick moving into TR/RTR position. Backrest inclination from +60° to -5° in Trendelenburg position, leg rest from -80° to +5°.

Reclinable arm-rests can be height adjusted or rotated up to 180° when removed. Four adjustable feet ensure maximum stability (27557 and 27563) or 4 castors, 2 with directional brake (27567) ensure mobility. Load: 150 kg. Size: 175x55xh 51 cm.

- 27553 IV STAND
- 27556 COUCH ROLL HOLDER

Other colours available in 20 days, see below:

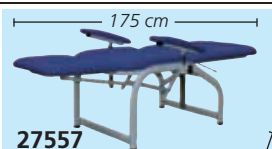

27557



WITH WHEELS



27567



27557

White ral colour 9003 structure, minimum thickness 70/80 micron. Glossy finish.



MADE IN ITALY



27563

ELECTRICAL

## DONOR WHEELCHAIR

- 27561 DONOR WHEELCHAIR
- Donor wheelchair with structure made of epoxy painted oval and round steel tube. Backrest adjustable by gas pump. Padded leg rest manually adjustable. Metal footrest extractable. Armrest with articulations, manually adjustable in height. Padding made of high-density polyurethane foam, fireproof Class 1 IM. Covering made of washable, plastic material (leatherette), fireproof Class 1 IM. Back push handle. Mattress overall size: 166x55 cm. Carton size: 185x67xh 58 cm. Four wheels Ø 100 mm, 2 directional and 2 with brake. Net weight: 53 kg. Gross weight: 55 kg. Maximum load: 150 kg. Supplied with blanket tray with belts to fix oxygen bottle, IV stand and chart holder support.



Chart holder support



MADE IN ITALY



27561

Blanket tray with belts to fix oxygen bottle (bottle not included)

## HEIGHT ADJUSTABLE GYNAECOLOGICAL BED

- 27506 HEIGHT ADJUSTABLE GYN BED - green
- 27507 HEIGHT ADJUSTABLE GYN BED - blue
- 27496 HEIGHT ADJUSTABLE GYN BED - any colour\*

\*Available in 20 days, see below available colours

Strong and solid structure in oval tube 50x25x2 mm painted with epoxy powder, white colour. The three sections top has high density padding, covered with washable, fire proof, leatherette material Class 1 IM.

### Full adjustable

Height, up to 95 cm, is adjustable by electric engine (6000 N power) with foot control, head section is adjusted by a gas cylinder (400 N power), central section by a gas cylinder (600 N power) up to 65°. This gyn bed is supplied with 2 quality foam leg holders, stainless steel tray and couch roll holder.

- 27509 QUALITY LEG HOLDER - couple - spare
- Kit leg holder includes 2 leg holder and arms. Suitable for 27496, 27505, 27506, 27507.

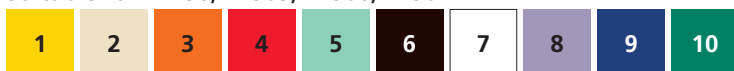

MADE IN ITALY

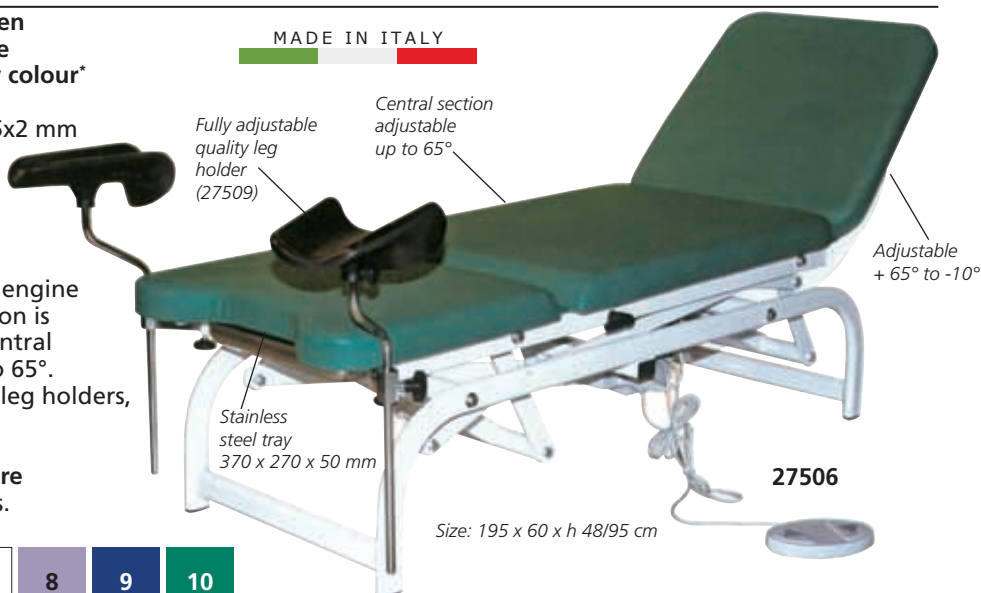

27506

Size: 195 x 60 x h 48/95 cm

Fully adjustable quality leg holder (27509)

Central section adjustable up to 65°

Adjustable + 65° to -10°

Stainless steel tray 370 x 270 x 50 mm

# ENT CHAIRS

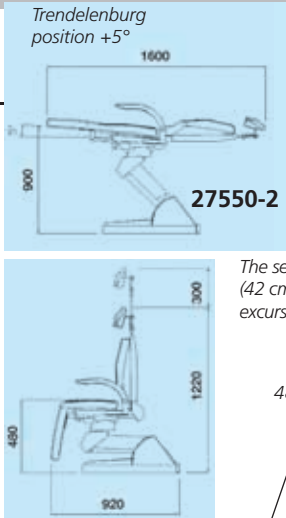

- 27545 NEW OTO/PV ENT CHAIR with headrest - colour on request\*
- 27548 NEW OTO/PV ENT CHAIR with headrest - green Melbourne
- 27549 NEW OTO/PV ENT CHAIR with headrest - light blue Parigi

Patient chair with Peltex-lined seat and backrest. Electric up and down movements by silent engine controlled through foot switch. Back-rest can be adjusted up to -5° +90° by a gas spring. Chair rotates 360° and is provided with a rotation locking device placed at the bottom. Power: 230 V - 50 Hz (Available 110 V - 60 Hz).

- 27550 OTOPEX ENT CHAIR with headrest - colour on request\*
- 27551 OTOPEX ENT CHAIR with headrest - blue Chicago
- 27552 OTOPEX ENT CHAIR with headrest - green Toronto

ENT chair designed also for ambulatory operations. Moved by very silent electrical engines operated by joystick foot-control. Also provided with button to re-set to previously selected working position. Upholstery made of simulated leather, high density undeformable foam padding (50 kg/cm<sup>3</sup>). Seat and leg-rest are joined in a single piece. Power: 230 V - 50 Hz (Available 110 V - 60 Hz).

# ENT CABINETS

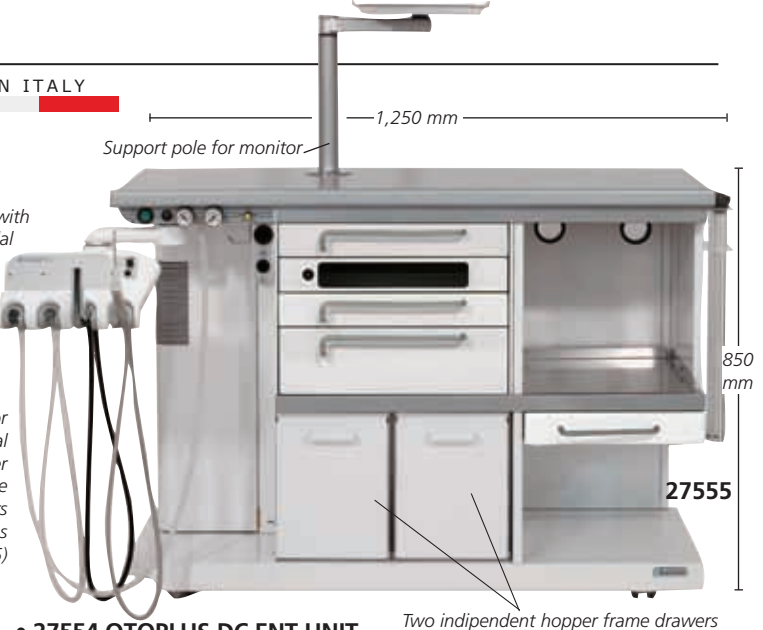
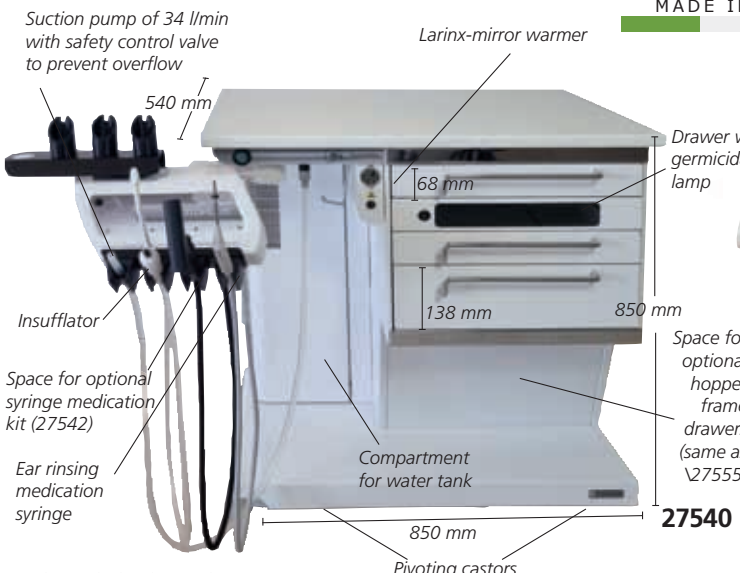

- 27540 OTOPLUS - ENT UNIT

The E.N.T. unit has rubber pivoting castors, a working surface made of scratch-proof rolled sections, 2 small and one large drawers provided of removable internal partitions, one drawer with inside germicidal lamps to keep instrument sterilization. Otoplus is provided with a silent suction pump of 34 l/min, with power supply complete with dim adjustment device for Clar/Storz lamp, larynx-mirror warmer, twin-cylinder dry compressor for tubal insufflation, 2-litres distilled water tank with acoustic signal for reserve level. The articulated arm with instrument holding tray is complete with terminal suction cannula and terminal insufflation cannula, ear rinsing syringe with automatic water temperature control, (a microprocessor keeps temperature at a constant level of 37 °C). Power 230 V - 50 Hz (Available 110 V - 60 Hz).

- 27539 OTOPLUS COMPLETE

Same as code 27540 with vasister drawers (code 27541) and endoscope support (code 27543) included.

- 27554 OTOPLUS DC ENT UNIT
- 27555 OTOPLUS DC ENT UNIT - complete
- 27541 HOPPER FRAME DRAWERS - 2 independent drawers
- 27543 ENDOSCOPE SUPPORT - 2 transparent plastic tubes 1 tube 50 cm long and 1 tube 25 cm long both closed at the bottom.
- 27542 SYRINGE MEDICATION KIT including 1 syringe, 2 atomizers (1 for liquid and 1 for powder) and 3 ampoules in dark glass. To be ordered with ENT unit, should be installed at factory.
- 28239 FILTER - spare for 27539, 27540, 27554-5
- 27544 LED LIGHT SOURCE

Makes cold white light (5500 °K, 200 lumen) for endoscopy use. It can be connected to endoscopes without need of F.O. cable. Handle connect directly to rigid endoscopes (Storz connection). LCD display: 12.8x6.4 cm

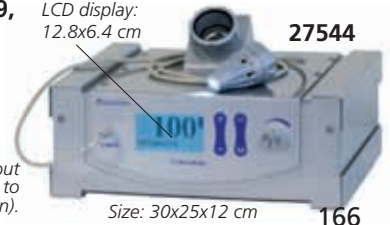

## ELECTRIC CHAIRS WITH FOOT CONTROL - 3 MOTORS

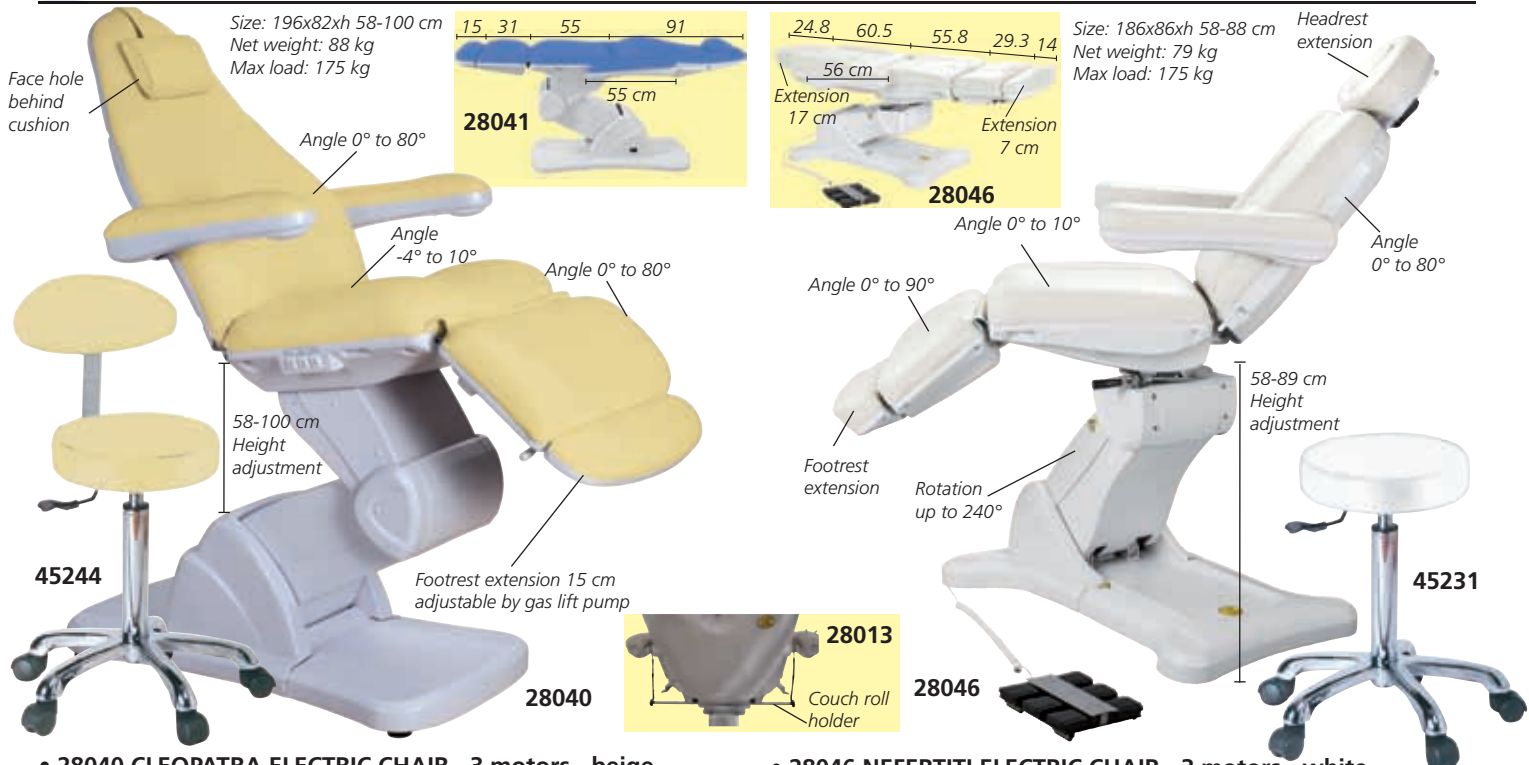

- 28040 CLEOPATRA ELECTRIC CHAIR - 3 motors - beige
  - 28041 CLEOPATRA ELECTRIC CHAIR - 3 motors - blue
- Electrically controlled 3 motors chair to adjust separately height, backrest and seat inclination by foot switch or push button panel. Footrest adjustable by gas lift pump. Reversible arms and adjustable headrest. Cushion included. Operating power: 100-240 V - 50/60 Hz. Manual: GB, FR, IT, ES.
- 28013 COUCH ROLL HOLDER - optional
  - 28014 REMOTE HANDLE CONTROL - optional
  - 45232 STOOL - blue
  - 45242 STOOL WITH BACKREST - blue
  - 45234 STOOL - beige
  - 45244 STOOL WITH BACKREST - beige

- 28046 NEFERTITI ELECTRIC CHAIR - 3 motors - white
- Electrical chair with very stable structure and high comfort. Specially designed to optimize the workspace due to 240° rotation. 3 motors control height, backrest and seat inclination by foot switch or push button panel. Footrest adjustable by gas lift pump, reversible arms and adjustable headrest. Operating power: 220-240 V - 50/60 Hz. Manual: GB, FR, IT, ES.
- 28013 COUCH ROLL HOLDER - optional
  - 45231 STOOL - white
  - 45241 STOOL WITH BACKREST - white

## MECHANICAL CHAIR



- 28005 LUXOR CHAIR - mechanical - white
  - 28006 LUXOR CHAIR - mechanical - blue
- Chair can move up and down and rotate 360°. Backrest and footrest are adjustable. Removable armrests.
- STOOLS**
- 45231 STOOL - white
  - 45232 STOOL - blue
  - 45241 STOOL - white
  - 45242 STOOL - blue

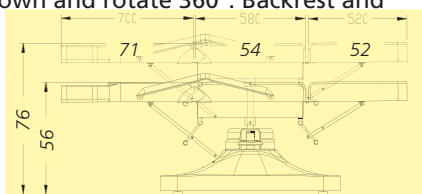

## ELECTRIC CHAIR- 2 MOTORS



- 28008 AMIRA CHAIR - 2 motors - white
  - 28009 AMIRA CHAIR - 2 motors - blue
- Electrically controlled chair to adjust separately height and backrest. Manual adjustment of angle of the seat inclination and footrest. Supplied with cushion. Manual: GB, FR, IT, ES.
- STOOLS**
- 45231 STOOL - white
  - 45232 STOOL - blue
  - 45241 STOOL - white
  - 45242 STOOL - blue

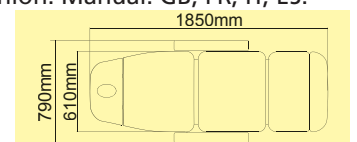

## ELECTRIC CHAIRS WITH FOOT CONTROL - 4 MOTORS



Size: 185x88xh 63-90 cm  
Net weight: 98 kg  
Max load: 175 kg

28048

- 28047 SABA ELECTRIC CHAIR - 4 motors - white
  - 28048 SABA ELECTRIC CHAIR - 4 motors - dark blue
- Electrically controlled 4 motors chair to adjust separately angle of the backrest, seat inclination, footrest and lifting of the whole chair. Hand controller and built-in foot controller which allow operator to adjust chair. High-grade upholstery leather easy to clean and fresh feeling. Headrest with face hole. Supplied with removable cushion and remote controller. Metal base for high stability. Operating power: 100-240V - 50/60Hz. Manual: GB, FR, IT, ES.
- 28013 COUCH ROLL HOLDER - optional
  - 45231 STOOL - white
  - 45235 STOOL - dark blue
  - 45241 STOOL WITH BACKREST - white
  - 45245 STOOL WITH BACKREST - dark blue



45235

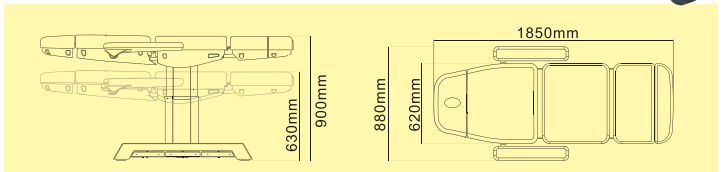

## PODOLOGY CHAIRS

Size: 186x86xh 58-89 cm  
Net/Gross weight: 72/92 kg  
Max load: 175 kg  
Operating power: 220-240 V - 50/60 Hz.



45232

Size: 180x80xh 51-65 cm  
Net weight: 41 kg  
Max load: 175 kg



28020

- 28025 ELECTRIC PODOLOGY CHAIR - 3 motors - blue
- Electrically controlled chair to independently adjust height, backrest and seat inclination, by foot switch or push button panel. Headrest can be inclined, arm rests are movable. Manual: GB, IT.
- 28013 COUCH ROLL HOLDER
  - 45232 STOOL - blue
  - 45242 STOOL WITH BACKREST - blue

- 28020 PODOLOGY CHAIR - mechanical - white
- This chair can move up and down and rotate. Backrest and footrests are adjustable. Heavy round base provides maximum stability. Manual: GB, IT.
- 45231 STOOL - white
  - 45241 STOOL WITH BACKREST - white

## PODOLOGICAL CABINETS

- 28030 GAMMA1 CABINET - 61x45xh 77 cm - small
- 28031 GAMMA3 CABINET - 108x45xh 77 cm - large

Equipped with tabletop in scratch-resistant wood, drawers and doors, designed to keep tools sterile. Supplied with connections to the mains: germicide compartment, lampholder and other electric sockets. Power supply: 220 V - 50/60 Hz.

	Cabinet		Table top		Germicide compartment	Large compartment
	28030	28031	28030	28031		
Length:	61 cm	108 cm	61 cm	108 cm	28 cm	28 cm
Width:	45 cm	45 cm	42 cm	42 cm	38 cm	28 cm
Height:	77 cm	77 cm			4 cm	15 cm



28030

28031

## GIMA ADJUSTABLE HEIGHT ELECTRIC TABLES - FOOTSWITCH

Sturdy and highly stable examination and treatment table with white metal painted frame. Adjustable height by electric footswitch. Fixed leg-section and manually adjustable head-section with mouth-nose hole. Available in 12 colours. Fireproof padding. Class I Medical Devices, complies with MDR 2017/745. Lifting capacity: 135 kg. Length: 193 cm. Weight: 54 kg. Power supply 100-240 V, 50-60 Hz. Multilingual manual: GB, FR, IT, ES, PT, DE, GR. Matching stools see page 181.

MADE IN ITALY

ADJUST. HEIGHT ELECTRIC TABLE - FOOTSWITCH				
Electric table		Colour	No.	Mouth-nose hole plug - optional
27628	Electric table - footswitch	green	4	27625
27633	Electric table - footswitch	blue	2	27631
27634	Electric table - footswitch	beige	5	27620
27635	Electric table - footswitch	black	1	27621
27632	Electric table - footswitch	any colour*	other	27630

\*Available in 20 days, see beside available colours

ACCESSORIES	
27629	Couch roll holder
27650	Foot Switch - spare



## GIMA ADJUSTABLE HEIGHT ELECTRIC TABLES - FOOTBAR

Sturdy and highly stable examination and treatment table. Adjustable height by electric footbar. Adjustable head-section by gas pump with mouth-nose hole. Sturdy tubular steel frame painted with non-toxic epoxy powder, RAL 9010. Chromed footbar. Intended for professional use in hospitals, physiotherapy, treatments. Supplied with 6 cm thickness mattress and mouth-nose hole plug 23x11 cm included. Fireproof padding. Available in 12 colours. Class I, Medical Devices, complies with MDR 2017/745. Maximum overall dimensions 195x59,5xh 54-71 cm. Weight: 65 kg. Lifting capacity: 135 kg. Multilingual manual: GB, FR, IT, ES, PT, DE, GR.

MADE IN ITALY

ADJUST. HEIGHT ELECTRIC TABLE - FOOTBAR			
Electric table		Colour	No.
44520	Electric table - footbar	blue	2
44521	Electric table - footbar	beige	5
44522	Electric table - footbar	black	1
44525	Electric table - footbar	any colour*	other

\*Available in 20 days, see beside available colours

ACCESSORIES	
27629	Couch roll holder



## VARIABLE HEIGHT EXAMINATION COUCH WITH TR/RTR

- 44510 LORD VARIABLE HEIGHT EXAMINATION COUCH - water green - 5
- 44516 LORD VARIABLE HEIGHT EXAMINATION COUCH - any colour\*

\*available in 20 days, see below available colours

Stable and sturdy examination couch made of high quality tubular for furniture. Very practical and user friendly. Height adjustable thanks to the two electrical columns that can move simultaneously or separately (allowing the Trendelenburg/Reverse Trendelenburg position) by a push-button panel.

Under the top frame, an ergonomic lever activates a gas spring that reclines the cushions. High density, rubber padded, fire retardant and Class 1 IM top, covered in coated fabric (vinyl, synthetic leather, flame retardant Class 1 IM).

It can be cleaned with common detergents. MADE IN ITALY

Complies with: EU 93/42 CEE. Maximum load: 200 kg. Supplied with mouth/nose hole plug, paper roll holder and 4 adjustable feet.

- 44505 RETRACTABLE/REMOVABLE/TURNABLE WHEELS



# ELECTRIC OR HYDRAULIC HEIGHT-ADJUSTABLE TABLES

The padding is in medium-density foam covered with high quality fire retardant vinyl

adjustable +70° to -20°

MADE IN ITALY

The laterally open frame permits the access with patient lifting system or trolleys

Hydraulic version

27587

**BRUXELLES TABLES - electric or hydraulic**  
Examination and treatment table with high stability. Electric height adjustment by a foot-switch (low tension 24 V) or manual by hydraulic piston. One mobile section, gas-spring supported adjustment of the head-section (with mouth-nose hole) and fixed leg-section. The large head-section can be adjusted positively and negatively and serves as back-rest. Sturdy frame with all moving parts having self-lubricating components to avoid early wear and noise. Power 230 V - 50/60 Hz.

27595

WIDTH 80 cm

Standard 68 cm	Large 80 cm	BRUXELLES TABLES	SWL (Safe Working Load)
27587	27595	Electric - any colour**	200 kg
27588	27593	Electric - blue	200 kg
27589	27596	Hydraulic - any colour**	250 kg
27586	-	Hydraulic - blue	250 kg

\*\*Available in 30 days

**TRENDELENBURG**

47 to 97 cm

8 cm

MADE IN ITALY

Armrests

27602/3 + 27591

27602-4

27599 + 27591

**THE TRENDELENBURG TABLES - electric or hydraulic**  
Examination and treatment tables with electric height adjustment by a foot switch (low tension 24 V) or hydraulic height adjustment by a piston. Features: three mobile sections adjustable by gas spring. The table can easily assume the "flexion", "relax" and "Trendelenburg" position even if the patient is lying on the table. The large head-section (with mouth-nose hole) can be adjusted positively and negatively. Chair position. Power 230 V - 50/60 Hz. Supplied with mouth-nose hole plug.

GIMA code	THE TRENDELENBURG TABLES	SWL (Safe Working Load)
27602	Electric - any colour**	200 kg
27603	Electric - blue	200 kg
27599	Electric with armrests - blue	200 kg
27604	Hydraulic - any colour**	250 kg

\*\*Available in 30 days

**6 SECTIONS AND TRENDELENBURG**

48 to 100 cm

Retractable wheels: once wheels are retracted table stands on frame

27578 + 27591

MADE IN ITALY

Armrests

27581

27583 + 27591

**SINTHESI MI.TO TABLES - electric**  
Two-motor examination and treatment tables, electric height adjustment by foot rail or a low voltage (24 V) foot switch. The couches have six or eight sections: the trunk section can be electrically adjusted by the operator with no effort, using the keyboard behind the head of the table, while the patient undergoes a treatment; other sections can be adjusted by one or more gas springs system. The head section is equipped with an elongated breathing hole for a higher comfort. It's a dedicated therapy table for the myofascial release techniques and postural analysis. Wide range of possible positions in flexion/extension, symmetrical or asymmetrical. Power 230 V - 50/60 Hz. Supplied with mouth-nose hole plug and postural education exercises manual.

GIMA code	SINTHESI MI.TO. TABLES	Sections	SWL*	Height adjustment
27578	Electric - blue	6	180 kg	foot switch
27579	Electric - any colour**	6	180 kg	foot switch
27581	Electric - any colour**	6	180 kg	foot rail
27583	Electric with armrest - any colour**	8	180 kg	foot switch

\*SWL: Safe Working Load

\*\*Available in 30 days

Upholstery colour code

TABLES AVAILABLE IN 24 COLOURS

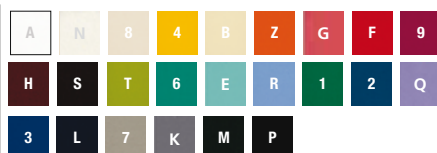

GIMA code	ACCESSORIES FOR ALL TABLES
27591	Wheels set Ø 6.5 cm*** - retractable
27594	Mouth-nose hole plug - any colour** for Bruxelles tables
27590	Couch roll holder for rolls 50 to 63 cm for Bruxelles and Ther tables
27592	Couch roll holder for rolls 50 to 68 cm for Sinthesi tables

\*\*Available in 30 days

\*\*\*Optional wheels set to be ordered with table

## 2 SECTION EXAMINATION COUCHES - CHROMED AND STAINLESS STEEL

- 44461 CHROME PLATED EXAMINATION COUCH
- 44463 STAINLESS STEEL EXAMINATION COUCH

MADE IN ITALY

LOAD  
150 kg

Structure made of chrome plated steel (44461) or stainless steel (44463) tube Ø 25x25 mm.  
Backrest adjustable by rack.  
Padding and covering made of washable, flame retardant, plastic material. Rubber feet.  
Supplied with a paper roll holder, which can be placed either in the front or in the back part of the examination couch.  
Fireproof padding and covering, Class 1 IM.  
Dimension: 177x60xh 75 cm.  
Weight: 25kg  
Delivered disassembled.



## KING HEIGHT ADJUSTABLE EXAMINATION COUCH

- 27613 KING HEIGHT ADJUSTABLE EXAMINATION COUCH - blue - 9
- 27612 KING HEIGHT ADJUSTABLE EXAMINATION COUCH - any colour\*

\*available in 30-40 days, see below available colours

Height adjustable (48-95 cm) examination couch by electric actuator (Linak engine 6.000 N) controlled by foot switch with head section easily adjustable (to +60° and -10°) by a gas pump.  
Strong and stylish leg structure in oval tubing 50x25x2 mm, central frame in rectangular tubing 50x20x1.5 mm painted with RAL 9003 white epoxy powder.  
Minimum thickness 70/80 micron, glossy finish.  
High density polyurethane foam platform with wooden base covered by leatherette upholstery.  
Both materials are fireproof Class 1 IM.  
Leatherette washable with the most common detergents. Size: 190x60xh 48/95 cm  
Weight: 70 kg  
Maximum load: 150 kg.  
Couch roll holder included.

MADE IN ITALY



## SUN 2-SECTION VARIABLE HEIGHT TREATMENT COUCH

- 44530 SUN 2-SECTION VARIABLE HEIGHT TREATMENT COUCH - orange - 3
- 44536 SUN 2-SECTION VARIABLE HEIGHT TREATMENT COUCH - any colour\*

\*available in 20 days, see below available colours

Couch made in high quality tubular that makes it very sturdy.  
The cushions can be reclined by a gas spring activated by an ergonomic lever under the top frame.  
Head section movable to +45° and to -30°.  
Height adjustable thanks to the two electrical columns by a push-button panel.  
High density, rubber padded, fire retardant and Class 1 IM top, covered in flame retardant Class 1 IM coated fabric (synthetic leather).  
Washable and disinfected with common detergents.  
Overall size: 195x68xh 48/89 cm. Weight: 80 kg.  
Complies with: EU 93/42 CEE.  
Maximum load: 200 kg.

Supplied with mouth/nose hole plug, paper roll holder, 2 adjustable armrests and 4 adjustable feet.

- 44505 RETRACTABLE/REMOVABLE WHEELS
- 44540 WEDGE CUSHION 50x50xh 15 cm - orange
- 44545 WEDGE CUSHION 50x50xh 15 cm - any colour\*
- 44550 SEMI-CYLINDRICAL CUSHION 20x50xh 10 cm - orange
- 44555 SEMI-CYLINDRICAL CUSHION 20x50xh 10 cm - any colour\*

\*Available in 20 days, see below available colours





## KING EXAMINATION COUCH

### KING EXAMINATION COUCH

Strong and stilish structure in oval tube 50x25 mm painted with metallic grey epoxy powder.

Top in washable, fire proof, leatherette material class 1 IM with high density padding. Head section adjustable by mechanical system, maximum 75°.

Mattress thickness: 4.5 cm

Size: 190x60xh 80 cm. Maximum load: 150 kg.

Delivered in kit form.

GIMA Code	KING EXAMINATION COUCH
27614	King examination couch - water green - 5
27615	King examination couch - white - 7
27616	King examination couch - blue - 9
27617	King examination couch - black - 6
44486	King examination couch - any colour*
KING EXAMINATION COUCH WITH HOLE	
27618	King examination couch - green
27619	King examination couch - white

\*available in 20 days, see below available colours



ACCESSORIES	
27511	Couch roll holder
27978	Foot stool - 1 step
27979	Foot stool - 2 steps



WIDTH: 60 cm  
MAX LOAD 150 kg

## KING PLUS EXAMINATION COUCH

- 44490 KING PLUS EXAMINATION COUCH - blue - 9
- 44491 KING PLUS EXAMINATION COUCH - beige - 2
- 44496 KING PLUS EXAMINATION COUCH - any colour\*

\*available in 20 days, see below available colours

Same as King examination couch, but with extra thick 7 cm mattress with lateral white band

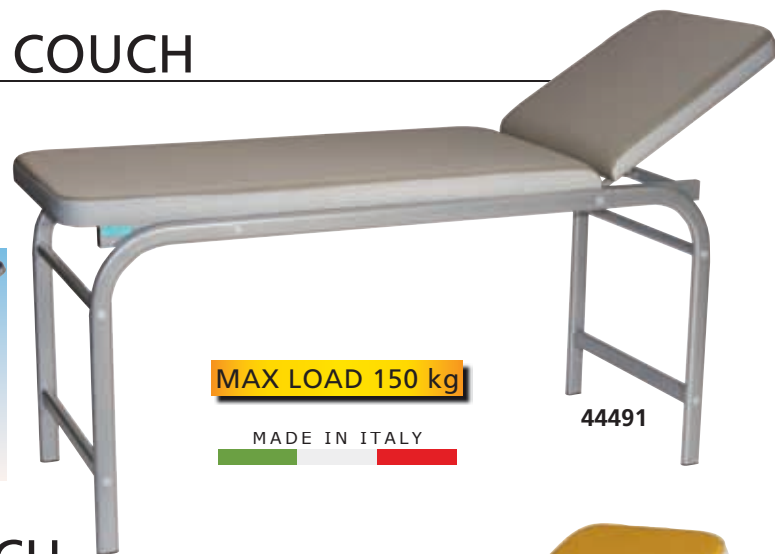
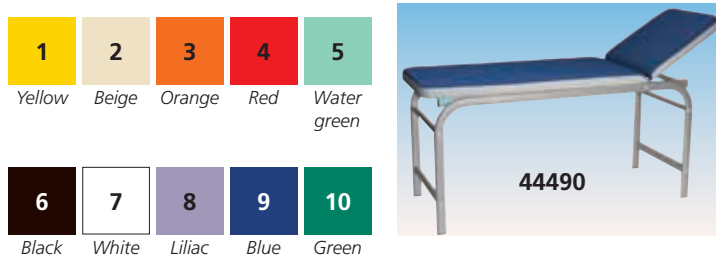

MAX LOAD 150 kg  
MADE IN ITALY

## ELITE EXAMINATION COUCH

- 44500 ELITE EXAMINATION COUCH - blue - 9
- 44503 ELITE EXAMINATION COUCH - any colour\*

\*available in 20 days, see below available colours

Stylish, comfortable and innovative examination couch available in 10 colours with lateral white band. Realized with high quality furniture tubing that guarantees stability and robustness.

The couch is made with rectangular and rounded tubing, Uni 7947/81 and 8913, DIN 2394.

Fireproof rubber padding covered with class 1 IM fireproof woven imitation leather.

Adjustable head section through 2 cogwheels.

The roll holder, included, can be placed in the feet or in the head side. 4 adjustable feet.

Size 193x68xh 78 cm. Padding size 190x68xh 7 cm. Max. load 200 kg. Weight 70 kg.

Disassembled, very simple to assemble.

- 44505 RETRACTABLE/REMOVABLE/TURNABLE WHEELS

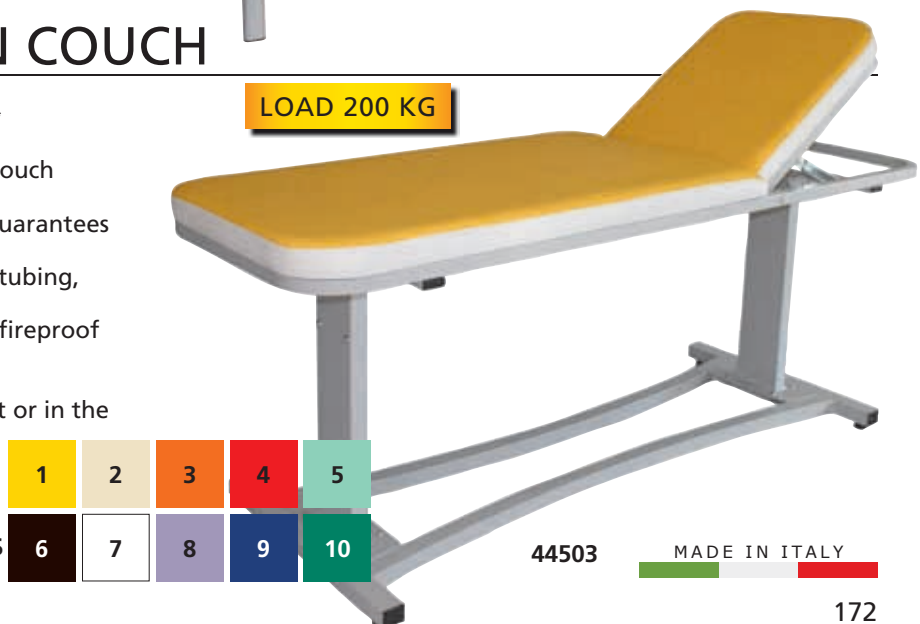

LOAD 200 KG

44503 MADE IN ITALY

## COUCH PAPER ROLLS

### COUCH PAPER ROLLS

A complete range of hygienic and resistant couch paper manufactured in Italy in pure cellucotton or cellucotton/polythene. Each roll is individually packed in plastic bag for best protection. Atoxic. Available with standard 38 or 40 cm perforation or 190 cm perforation (full person size).

#### • 27418 COUCH ROLL HOLDER

Adjustable roll holder suitable for round (Ø 27-30 mm) or square (27-30 mm x 27-30 mm) metal couch leg.

MADE IN ITALY

OTHER SIZES OF COUCH ROLL PAPERS AVAILABLE ON REQUEST

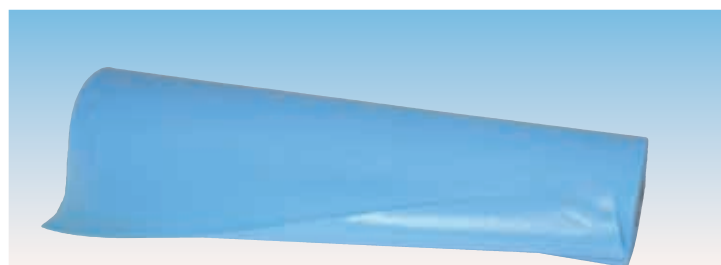

### COUCH PAPER ROLLS

MATERIAL	Cellucotton embossed		Microembossed glued mikrogeprägt verleimt - gauffré collé						Pure wadding of cellulose ply coated with a polythene protection			
	GIMA code	27410	27411	27412	27424	27427	27428	27432	27419	27414	27413	27415
Colour		white	white	white	white	white	white	white	white	light blue	white	white
Ply		1 ply	2 ply	2 ply	2 ply	2 ply	2 ply	2 ply	2 ply	14 g/m <sup>2</sup> polyth.	14 g/m <sup>2</sup> polyth.	8 g/m <sup>2</sup> polyth
Weight		30 g/m <sup>2</sup>	2x20 g/m <sup>2</sup>	2x17 g/m <sup>2</sup>	2x17 g/m <sup>2</sup>	2x17 g/m <sup>2</sup>	2x17 g/m <sup>2</sup>	2x17 g/m <sup>2</sup>	2x17 g/m <sup>2</sup>	26/28 g/m <sup>2</sup> ,	26/28 g/m <sup>2</sup> ,	26/28 g/m <sup>2</sup>
Length		95 m	47.5 m	46 m	50 m	100 m	50 m	80 m	80 m	50 m	50 m	50 m
Height		50 cm	59 cm	50 cm	50 cm	50 cm	59 cm	59 cm	59 cm	50 cm	50 cm	60 cm
Number of sheet		250	125	135	132	263	132	210	42	132	132	125
Perforation		38 cm	38 cm	34 cm	38 cm	38 cm	38 cm	38 cm	190 cm	38 cm	38 cm	40 cm
Rolls per box		6	6	9	9	6	9	6	6	6	6	6

## SUITCASE COUCH

MADE IN ITALY



Couch size:  
187.5x64xh 71 cm (open)  
93x68xh 14 cm (folded)

• **27407 SUITCASE COUCH - black**  
Chromed steel and folding legs.  
Upholstered covering in washable material. Resin padded.  
Max load: 100 kg.  
Weight: 16.5 kg  
Supplied with a velvet bag for easy transport.  
Packing: 95x18x73.5 cm  
Manual: GB, IT, NL.

## ALUMINIUM SUITCASE COUCH

MADE IN ITALY



Manual: GB, FR, IT, ES, PT, DE, GR.

• **27406 ALUMINIUM SUITCASE COUCH with hole**  
Light, foldable, two sections, suitcase couch with aluminium frame. Central double legs for improved safety and block system on the hinges.  
Head rest with mouth/nose hole.  
Upholstered and covered with simulated leather.  
Max load: 100 kg.  
Weight: 13 kg.  
Packing: 94x21.5x66.5 cm

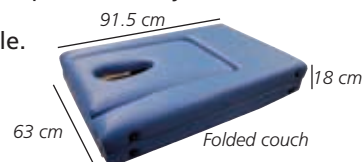

## VALUE EXAMINATION COUCHES

- 44452 VALUE EXAMINATION COUCH - white painted - black
  - 44453 VALUE EXAMINATION COUCH - white painted - white
  - 44457 VALUE EXAMINATION COUCH - chrome - blue
  - 44458 VALUE EXAMINATION COUCH - chrome - beige
- Suitable for medical practices or small surgeries.  
 Top is made with wooden panel, foam rubber and covered with washable, fireproof simulated leather Class 1.  
 Two sections: one fixed 131x62xh 6 cm and one adjustable (backrest) 51x62xh 6 cm.  
 Couch size: 182x62xh 79 cm.  
 Weight 27 kg.  
 Maximum load: 120 kg.  
**Delivered in kit form:** 173x74xh 16 cm. Easy to assemble.  
 Multilanguage manual (GB, FR, IT, ES, PT, DE).
- 27418 COUCH ROLL HOLDER - optional
- STOOLS:** see at page 181

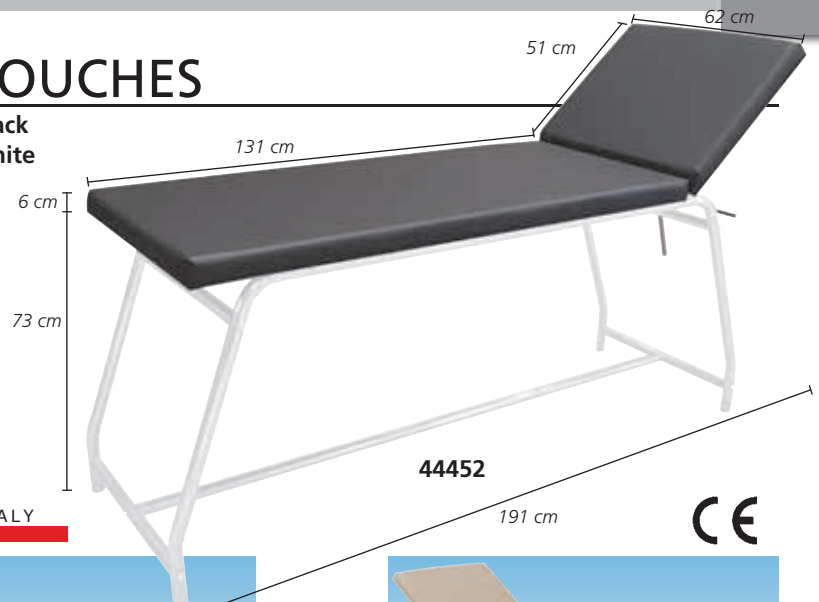

## EXAMINATION COUCHES

- 27401 EXAMINATION COUCH - chromed - black
  - 27402 EXAMINATION COUCH - white painted - grey
  - 27444 EXAMINATION COUCH - white painted - green
- STOOLS:** see matching stools page 181
- Suitable for medical office or small surgeries.  
 Easy to assemble, following enclosed instructions (GB, FR, IT, ES, PT, DE, SE).  
 Comes complete with mattress.  
 Upholstery in two sections:  
 one 131x62xh 6 cm fixed  
 and a 51x62xh 6 cm backrest  
 adjustable through different positions.  
 Load: 120 kg.  
 Net weight 26.4 kg  
**Delivered in kit form** (173x16x74 cm).

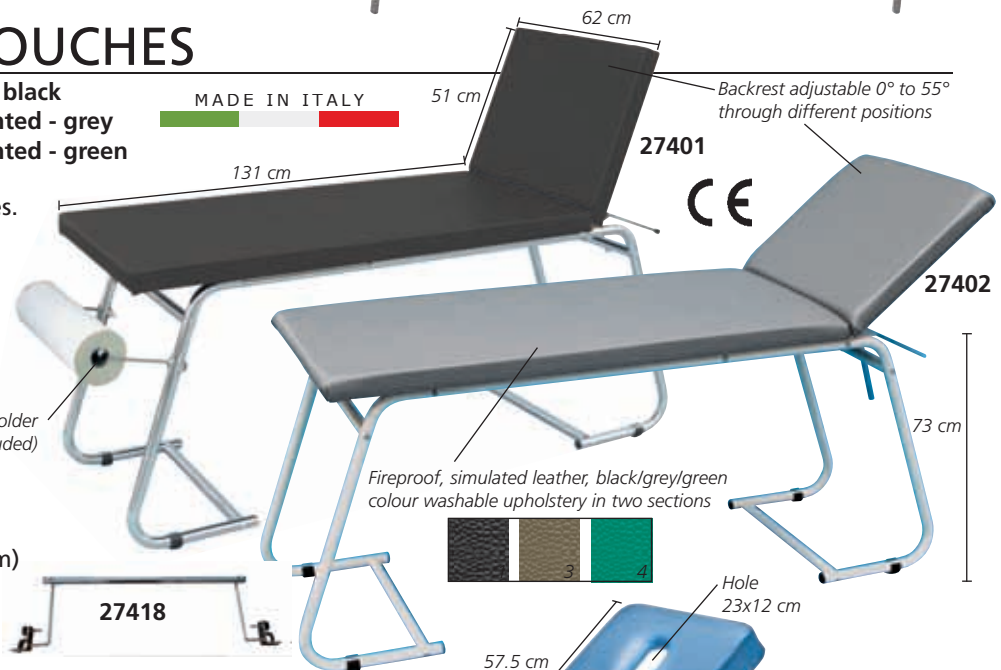

- 27404 CLASSIC EXAMINATION COUCH - chromed - beige
  - 27405 CLASSIC EXAMINATION COUCH - chromed - blue- backrest with hole
  - 27445 CLASSIC EXAMINATION COUCH - chromed - apricot
- Chromed mainframe and legs constructed in chrome-plated steel.  
 Legs fitted with plastic feet.  
 The two-section top has resilient foam padding covered with washable and fire-proof plastic material.  
 Backrest fully adjustable.  
 Available in beige, blue, apricot colour.  
 Other colours on request, minimum 10 pieces.  
 Size: 180x57xh 73 cm.  
 Maximum load 120 kg.  
**Delivered in kit form** (198x17x64 cm).  
 Instructions: GB, FR, IT, ES, PT, DE, GR.
- 27408 MOUTH-NOSE HOLE PLUG 23x12xh 6 cm for 27405 - blue
- STOOLS:** see matching stools page 181

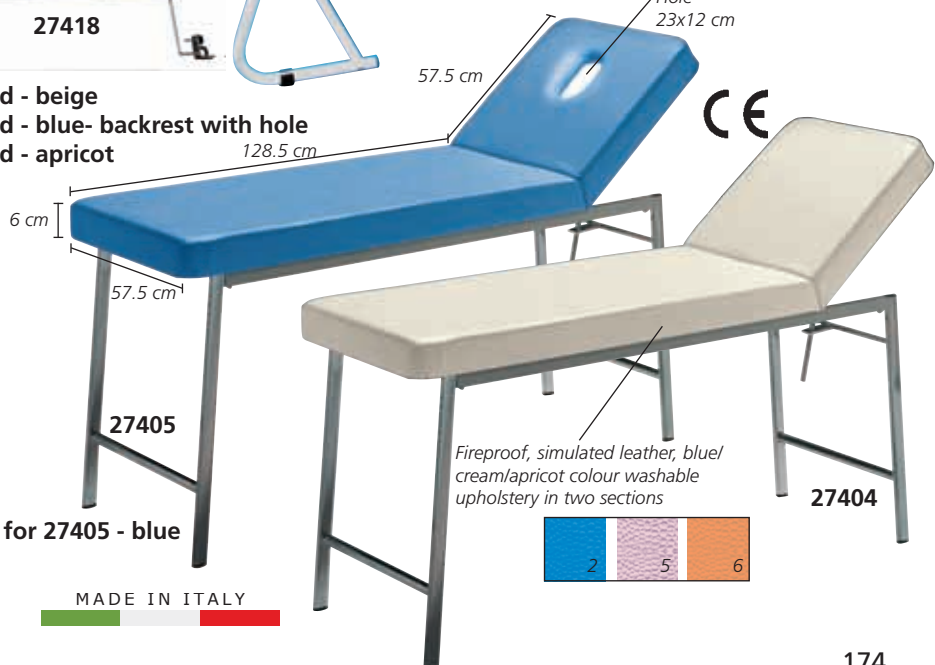

# EXAMINATION AND TREATMENT TABLE - HIGH LOAD

- 27622 STANDARD TREATMENT TABLE - any colour\*
- 27623 STANDARD TREATMENT TABLE - blue
- 27624 STANDARD TREATMENT TABLE - cream
- 27626 LARGE TREATMENT TABLE - any colour\*
- 27627 LARGE TREATMENT TABLE - blue

Professional examination and treatment table with one movable section and manual adjustment. Sturdy detachable metal structure painted with scratch-proof, non corrosive epoxy powder. The section trim facilitates reaching the patient. Head section with mouth-nose hole. Multilingual manual: GB, FR, IT, ES, PT, DE, GR.

- 27629 COUCH ROLL HOLDER
- 27630 MOUTH-NOSE PLUG - any colour\*
- 27631 MOUTH-NOSE PLUG - blue
- 27620 MOUTH-NOSE PLUG - cream

\*available in 30 days

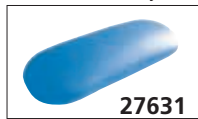

Deep 135 mm

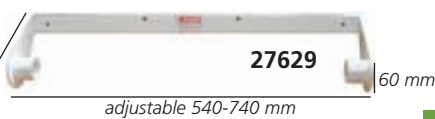

27631

**STD TABLE:**  
width 68 cm  
max load 180 kg



27622

High-density foam padding. Superior cover finish made of high-quality fireproof simulated leather. Vinyl is resistant to disinfectants, urine, and blood.

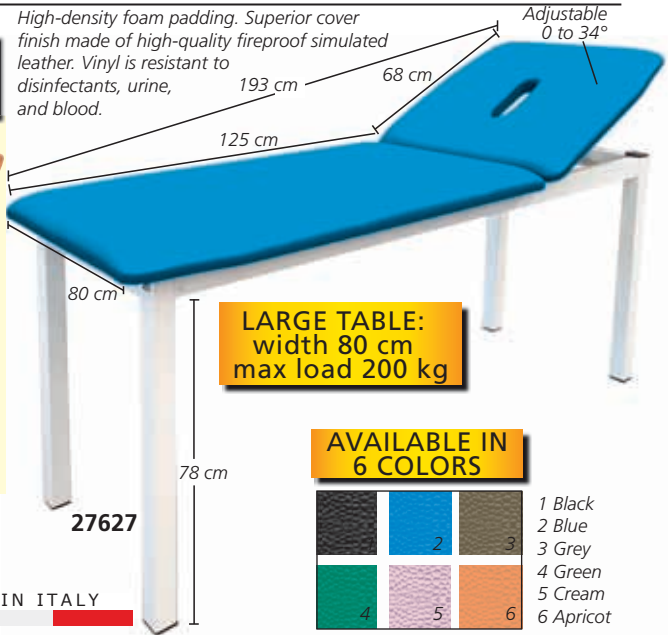

27627

**LARGE TABLE:**  
width 80 cm  
max load 200 kg

**AVAILABLE IN 6 COLORS**



- 1 Black
- 2 Blue
- 3 Grey
- 4 Green
- 5 Cream
- 6 Apricot

MADE IN ITALY

# WOODEN COUCHES

## WOODEN COUCHES

Comfortable couches, ideal for physical therapy, esthetics and wellness centres. Superior quality wood. Back rest adjustable in 13 positions. Resilient foam padding covered with washable skay. Padding in beige colour. Size: 190x70xh 75 cm.



27416

Directional wheels

27443



Delivered in kit form. Easy assembly, tool provided. Couch roll holder included only with 27450 and 27451 can be hung on back or front.



27451

Backrest adjustable in 13 positions

Mouth nose hole plug included

27452

Size: 50x40xh 77 cm  
Shelf load: 20 kg each

**MAXIMUM COUCH LOAD: 250 KG**

**MAXIMUM COUCH LOAD: 200 KG**



27417+27409

Mouth nose hole plug included.  
Average hole Ø 14 cm



27450

MADE IN ITALY

- 27416 WOODEN COUCH - beech
- 27417 WOODEN COUCH - with face hole - beech
- 27443 DANTE WOODEN TROLLEY - beech
- 27409 COUCH ROLL HOLDER for 27416 and 27417

- 27450 FIRENZE WOODEN COUCH - wenge
- 27451 FIRENZE WOODEN COUCH - with face hole - cherry wood
- 27452 DANTE WOODEN TROLLEY - cherry wood

## FOLDABLE MASSAGE TABLE - WOOD OR ALUMINIUM

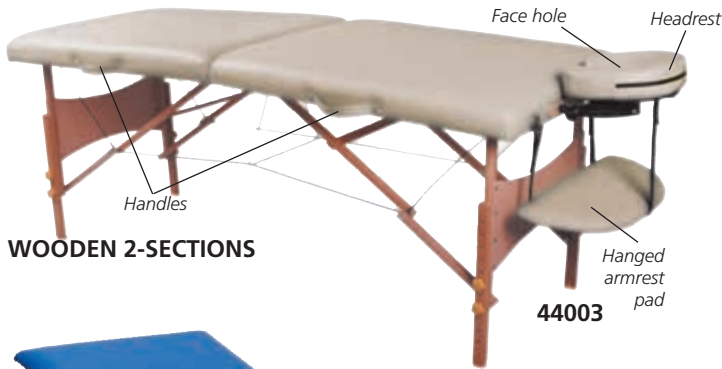

WOODEN 2-SECTIONS



WOODEN 3-SECTIONS



ALUMINIUM 2-SECTIONS

- 44000 2-SECTION WOODEN MASSAGE TABLE - black
- 44001 2-SECTION WOODEN MASSAGE TABLE - blue
- 44002 2-SECTION WOODEN MASSAGE TABLE - turquoise
- 44003 2-SECTION WOODEN MASSAGE TABLE - cream

Two-section foldable height adjustable massage table with German beech wood frame and PVC vinyl cover with 5 cm foam thickness. Tables are supplied with headrest, hanged armrest, mouth-nose plug and carrying bag. Product open size: 185x70xh 62/87 cm Packing size: 95x20xh 75 cm Net/Gross weight: 14/17 kg Maximum working load: 200 kg (441 lbs) Manual: GB, FR, IT, ES, PT, DE



Carrying bag for all tables

- 44011 3-SECTION WOODEN MASSAGE TABLE - blue
- 44013 3-SECTION WOODEN MASSAGE TABLE - cream

Three-section foldable height adjustable massage table with German beech wood frame and PVC vinyl cover with 5 cm foam thickness. Tables are supplied with headrest, armrests, hanged armrest, mouth-nose plug and carrying bag. Product open size: 185x70xh 62/87 cm Packing size: 95x20xh 75 cm Net/Gross weight: 16/19 kg Maximum working load: 220 kg (485 lbs) Manual: GB, FR, IT, ES, PT, DE



- 44020 2-SECTION ALUMINIUM MASSAGE TABLE - black
- 44021 2-SECTION ALUMINIUM MASSAGE TABLE - blue
- 44024 2-SECTION ALUMINIUM MASSAGE TABLE - white

Two-section foldable, height adjustable massage table with aluminium frame and PVC vinyl cover with 5 cm thickness. Tables are supplied with headrest, side armrests, hanged armrest, mouth-nose plug and carrying bag. Product open size: 186x70xh 59/80 cm Packing size: 95x20xh 75 cm Net/Gross weight: 13/16 kg Maximum working load: 250 kg (551 lbs) Manual: GB, FR, IT, ES, PT, DE



## MASSAGE BED WITH HOLE

- 27421 MASSAGE BED

Comfortable massage bed, with face hole and removable pillow. Ideal for physical therapy and wellness centres. Adjustable back rest 0 to 45 degree Supplied with couch roll holder and multilingual instructions (GB, FR, IT, ES).

Product size: 183x61x75 cm  
Packing size: 188x17x66 cm  
Net/Gross weight: 28/31 kg  
Maximum load: 175 kg



## FOLDABLE MASSAGE CHAIR

- 44050 FOLDABLE MASSAGE CHAIR

Comfortable foldable massage chair ideal for physical therapy and wellness centres. Made of PVC vinyl with 5-6 cm foam thickness Metal frame Packing size: 106x27xh 50 cm Net/Gross weight: 7/13 kg Maximum working load: 120 kg



Folded massage chair

## WING SCREEN WITH TREVIRA CURTAINS



45561 +  
3x45570

**SCREEN WITH TREVIRA CURTAINS**  
Build up the screen you need choosing among 4 frames and 6 colours of Trevira curtains.

**Wing screen**  
Aluminium alloy tubular frame mounted on feet or castors (Ø 50 mm).

Size: 150xh 167.5 cm (45560)

150xh 174 cm (45561)

200xh 167.5 cm (4 wings)

Packing size: 176x57x13 cm (all wing screens)

**Trevira curtains** are flame-proof (Class I), antiallergic, avoid bacterial growth, waterproof and highly resistant to abrasion. Thick weft to avoid dust infiltration and improve privacy, washable up to 60°C. Available in 6 colours to match any need. **Custom-made curtains available on request.**

Multilingual manual: GB, FR, IT.

Multilingual manual: GB, FR, IT.



Light blue

Blue

White

GIMA Code	WING SCREEN FRAME without curtain
45560	3 wing screen
45561	3 wing screen with castors
45562	4 wing screen
45563	4 wing screen with castors
GIMA code	CURTAINS* IN TREVIRA 45xh 129 cm
45570	Curtains - light blue
45571	Curtains - blue
45572	Curtains - white
45573	Curtains - beige
45574	Curtains - green
45575	Curtains - peach

\*you have to buy 3 or 4 curtains depending on frame you choose



MADE IN ITALY

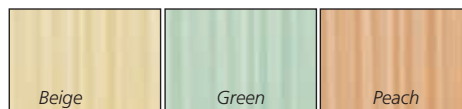

Beige

Green

Peach

## 3 OR 4 WINGS SCREEN WITH PLASTIC CURTAINS

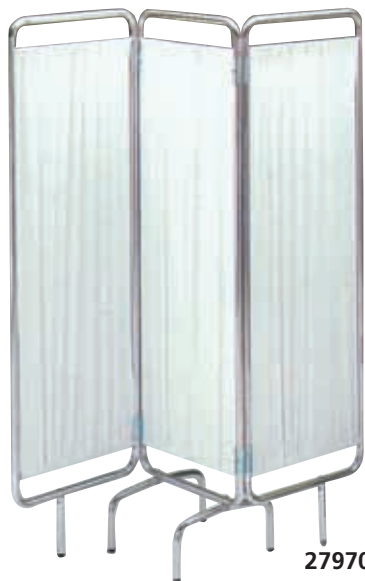

27970



27974

- 27970 3 WINGS SCREEN
  - 27971 3 WINGS SCREEN with castors
  - 27972 4 WINGS SCREEN
  - 27974 4 WINGS SCREEN with castors
- Aluminium alloy tubular frame.  
Weight 5 kg (3 wings), 8 kg (4 wings).  
Foldable washable white plastic curtains mounted on feet or castors (Ø 50 mm).  
Size: 150xh 170 cm - 3 wings (50 cm each)  
200xh 170 cm - 4 wings (50 cm each)

MADE IN ITALY

SEPARATION SYSTEMS AND CURTAINS see page 139

## 2 OR 3 WINGS WARD SCREENS WITH TREVIRA OR COTTON CURTAINS



45580

Height: 180 cm



45579

Width: 60+60 cm

- 45578 2 WINGS SCREEN - white cotton cloth
  - 45579 2 WINGS SCREEN - light blue Trevira
  - 45580 3 WINGS SCREEN - white cotton cloth
  - 45581 3 WINGS SCREEN - light blue Trevira
- Exclusive 2 or 3 wings ward screens with sturdy structure in oval tube (30x15 mm), painted with epoxidic powder metal grey.  
Light blue Trevira curtains or white washable cotton cloth.  
Equipped with 4 adjustable feet that ensure increased stability.  
Class I Medical Device complying with European Directive 93/42

MADE IN ITALY

Width: 60+60+60 cm

# CABINETS FOR MEDICINES AND INSTRUMENTS

CABINETS ARE SUPPLIED DISASSEMBLED

MADE IN ITALY



27898

Size: 52x35x138 cm  
Pack size: 65x26x134 cm  
Weight: 31 kg



27899

Size: 75x37x164 cm  
Pack size: 72x24x156 cm  
Weight: 45 kg



27900

Size: 75x37x164 cm  
Pack size: 72x24x156 cm  
Weight: 50 kg



27902

Size: 79x36x186 cm  
Pack size: 88x36x96 cm  
Weight: 56 kg

- 27898 VALUE CABINET - 1 door
- 27899 VALUE CABINET - 2 doors

Cabinets made of enamelled steel sheet with tempered glass doors. Hinged glass door with lock and key. Three stainless steel shelves adjustable in height. Delivered in kit form.

- 27900 VALUE CABINET - 4 doors (hinged)
- 27902 VALUE CABINET - 4 doors (2 hinged, 2 sliding)

Cabinets made of enamelled steel sheet with 2 overlapped compartments. Upper compartment with 2 tempered glass doors (hinged doors 27900 or sliding doors 27902), lock with key and 2 stainless steel, height adjustable shelves. Inferior compartment with 2 doors made of enamelled steel plate and 1 enamelled steel sheet shelf. Delivered in kit form.

# CABINETS WITH 1, 2, 4 DOORS AND WALL CABINETS

MADE IN ITALY



27901

27905

27903

Lower section with 1 steel shelf



27912

Hanging cabinet with 2 lockable doors. Inside division in 2 compartments left side with 2 removable shelves, right side with 1 removable shelf.



27911

Hanging cabinet to keep medicine with 2 glass tempered doors and 2 tempered glass shelves adjustable on master rack to be hung by two holes on the back. Supplied with lock.

**GIMA CABINETS** Choice of cabinets with epoxy coated steel structure and tempered glass. Rack-mounted adjustable glass shelves. Rubber feet.

TECHNICAL SPECIFICATIONS	27901	27905	27903	27911	27912
Door:	1	2	4	2	2
Adjustable glass shelves:	3	4	2	2	3
Weight kg:	30	47	45	16	18
Size cm:	53x36xh 144	75x38xh 169	75x38xh 169	60x30xh 60	80x33xh 45

- 27901 CABINET - 1 door
- 27905 CABINET - 2 doors
- 27903 CABINET - 4 doors
- 27911 WALL CABINET - glass sliding door
- 27912 WALL CABINET - painted door

# DOCTOR CABINET



MADE IN ITALY

GIMA code	Product	Description	Size	Weight
27920	DESK - with 2 drawers	Desk with 2 side drawers with locking top drawer and enamelled tubular steel frame	120x70x78	31
27403	EXAMINATION COUCH	Single-hinged examination table with aluminium tubular frame. Comes complete with simulated leather mattress (grey), backrest adjustable through different positions max 45°. Delivered in kit form.	176x60x78	22
27989	COAT HANGER	Free-standing coat hanger with chromed steel frame with 8 knobs and umbrella holder		5
27990	LIGHT	Aluminium tubular frame with 5 spoke base on 50 mm castors. Adjustable height thanks to flexible arm. Lamp 100 W. (connection E27) not included. Not medical device.		3

# STACKABLE CHAIRS



- 45007 STACKABLE CHAIR - blue
  - 45008 STACKABLE CHAIR - grey
  - 45011 STACKABLE CHAIR with arms - blue
  - 45012 STACKABLE CHAIR with arms - grey
- Chromed steel frame, self-extinguishing plastic seat. Stackable up to 20 chairs. Weight 5 kg (45007-8), or 7 kg (45011-2). Self-extinguishing Class 1. Maximum load: 110 kg.

MADE IN ITALY

# CHAIRS

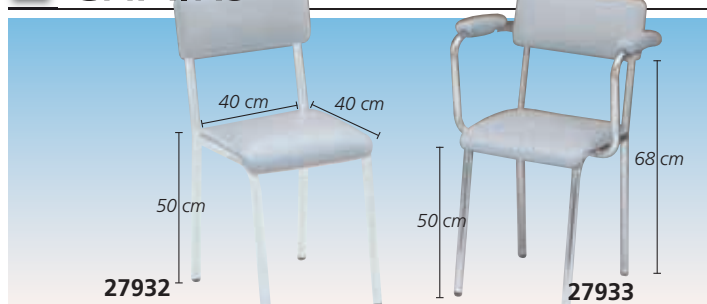

- 27932 CHAIR padded seat  
Stainless steel white painted frame chair with grey padded seat and back. Stackable. Load 120 kg.
- 27933 CHAIR padded seat with armchairs  
Same as 27932 but with padded arm-rests.

MADE IN ITALY

# S/S WASTE BINS WITH PEDAL

- 27984 WASTE BIN 9.5 l - with pedal - Ø 25xh 35 cm  
Made of enamelled steel with plastic inner bucket - weight: 2 kg
- 27985 S/S WASTE BIN 9.5 l - with pedal - Ø 25xh 35 cm  
Made of AISI 304 stainless steel with plastic inner bucket - weight: 2 kg
- 27986 S/S WASTE BIN 12 l with pedal - Ø 32xh 36 cm  
Made of stainless steel AISI 430. Metal handle for easy emptying. Removable inner plastic bucket.
- 27983 S/S WASTE BIN 70 l with pedal - Ø 42xh 72 cm  
Made of stainless steel. Non-slip rubber pedal. Two lateral handles avoid fingers pinching. Galvanized inner bucket with handle.





# DOCTOR CABINET



GIMA code	Product	Description	GIMA code	Product
45581	WING SCREEN Trevira curtain	3 wings screen with sturdy structure in oval tube, painted with epoxy powder metal grey. Light blue Trevira curtains. Curtains specifications see page	27616	KING EXAM. COUCH See page 172
45580	WING SCREEN	Same as above but with white washable cloth.	30723	ALFA-FLEX LIGHT See page 248
27921	TROLLEY	Structure in oval tube, painted with epoxy powder metal grey. White shelves with PVC edge, guard-rail on 3 sides. Size 50x60xh80 cm. Max load: 30 kg	27984	WASTE BIN See page 179
27987	COAT HANGER	Free standing coat hanger with 5 knobs, epoxy powder grey painted steel structure and umbrella holder.	45211	STOOL See page 181
			45082	CREMONA CHAIR See page 182

## DESK

### • 27919 DESK with 2 drawers

Desk with 2 lockable side drawers with strong structure in oval tube painted with epossidic powder, metal grey. White work top with rubber edge and round corner. Size 130x71xh 80 cm



MADE IN ITALY

## DESK WITH SIDES

### • 27922 DESK with sides and 2 drawers

Desk with sides and 2 side drawers. First drawer is lockable. Anti-reflective white melamine structure and top. Desk top has ABS edges on 4 sides with rounded corners. Sides complete with adjustable feet. Desk size: 120x70xh 73 cm. Drawer size: 35x40x h 24 cm. Delivered disassembled.



MADE IN ITALY

## FOOT STOOLS - 1 OR 2 STEPS

### • 27980 FOOT-STOOL - one step - aluminium

### • 27982 FOOT-STOOL - two steps - painted

Mounting steps with painted tubular frame and plastic foot board. Load 90 kg. Non slipping grey platform 40x20 cm. Size: 40x51xh 25 (27980), 40x53xh 44 (27982).

### • 27978 FOOT-STOOL - one step

### • 27979 FOOT-STOOL - two steps

Structure in oval tube 30x15 painted with epossidic powder. Non slipping black platform. Size: 45x26xh 20 cm (27978) 44x40xh 22/45 cm (27979) Maximum load: 100 kg

### • 27976 FOOT-STOOL - one step - disassembled

### • 27977 FOOT-STOOL - two steps - disassembled

Structure made of chrome plated steel tube with rubber feet. Load: 100 kg. Non slipping black plastic platform. Size: 40xh 24 cm (27976) 40xh 42 cm (27977) 45x27xh 9 cm (27976) 51x42xh 12 cm (27977)



DELIVERED DISASSEMBLED

# HEIGHT ADJUSTABLE STOOLS



MADE IN ITALY

AVAILABLE IN 6 COLORS

- 45200 STOOL 1 - black
- 45201 STOOL 2 - blue
- 45202 STOOL 3 - grey
- 45203 STOOL 4 - green
- 45204 STOOL 5 - beige
- 45205 STOOL 6 - apricot

Padded fireproof simulated leather seat Ø 33 cm.  
Height adjustable 47 to 57 cm.  
Metal base with 5 castors.

Maximum load: 120 kg

45200



MADE IN ITALY

45212

Maximum load: 150 kg

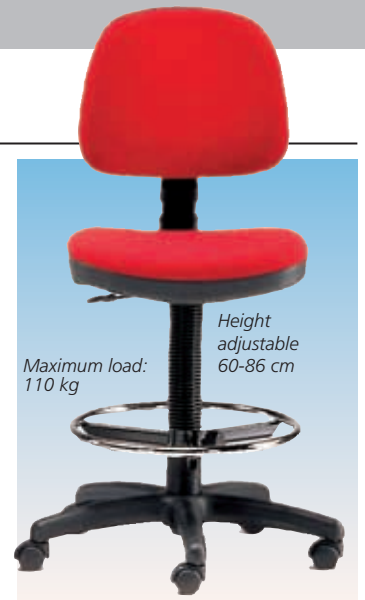

45222

Maximum load: 110 kg

Height adjustable 60-86 cm



- 45210 STOOL - black
- 45211 STOOL - blue
- 45212 STOOL - white

Padded simulated leather seat Ø 36 cm. Height adjustable 46-60 cm. Plastic base with 5 castors. Ø 50 mm.

- 45220 STOOL - black
- 45221 STOOL - white
- 45222 STOOL - red

Padded fire proof simulated leather seat and back. Height adjustable. Plastic base with 5 castors and chromed ring.



27949

Plastic base

Load: 150 kg

Castors Ø 50 mm

27954



MADE IN ITALY

27947

Load: 150 kg



27955

Load: 150 kg



27956

Load: 150 kg

- 27949 STOOL - feet
- 27954 STOOL - castors

Stainless steel seat AISI 304 Ø 32 cm. Height adjustable 45-64 cm (27949), 50-68 cm (27954).

- 27947 STOOL - feet

Stainless steel seat AISI 304 Ø 32 cm. Height adjustable 46-65 cm. Aluminium base with feet.

- 27955 STOOL - grey

Washable padded simulated leather seat Ø 31 cm. Height adjustable 48-67 cm. Plastic base with feet.

- 27956 STOOL - grey

Washable padded simulated leather seat Ø 31 cm. Height adjustable 53-71 cm. Plastic base with 5 castors Ø 50 mm.

# HEIGHT ADJUSTABLE STOOLS

# ERGONOMIC HEIGHT ADJUST. STOOLS



45232 45241

Multilingual instructions: GB, FR, IT, ES, PT, DE

- 45230 STOOL - black
- 45231 STOOL - white
- 45232 STOOL - blue
- 45234 STOOL - beige
- 45235 STOOL - dark blue

Padded simulated leather seat Ø 34 cm. Height adjust. 55 to 75 cm.

- 45228 CASTOR - spare

- 45240 STOOL - black
- 45241 STOOL - white
- 45242 STOOL - blue
- 45244 STOOL - beige

Padded simulated leather seat Ø 34 cm with backrest. Height adjustable 55 to 75 cm.

- 45228 CASTOR - spare



45250 45261

3 adjustments:  
Backrest angle  
Seat angle  
Adjustment of height

Multilingual instructions: GB, FR, IT, ES, PT, DE

- 45250 ERGO STOOL - black
- 45251 ERGO STOOL - white
- 45252 ERGO STOOL - blue

Ergonomically designed comfortable stool with saddle-shaped seat and height adjustment with a gas piston. Height adjustable 52 to 67 cm.

- 45228 CASTOR - spare

- 45260 ERGO B STOOL - black
- 45261 ERGO B STOOL - white
- 45262 ERGO B STOOL - blue

Ergonomically designed comfortable stool with saddle-shaped seat. Three levers with a gas piston allow adjustment of height, backrest angle and seat. Height adjustable 63 to 83 cm.

- 45228 CASTOR - spare

# OFFICE CHAIRS WITH OR WITHOUT ARMREST



45060

45071

45070

45065

45075

45060

45076

MADE IN ITALY

45075

Maximum load: 110 kg

Functional office upholstered chair, with armrests and polypropylene swivel base, movable backrest with permanent contact.

CUNEO CHAIR without armrest					
	Red	Grey	Black	Blue	Any colour*
Fabric	-	-	-	45060	45063
Leatherette	-	-	45065	-	45069

CUNEO CHAIR with armrest					
	Red	Grey	Black	Blue	Any colour*
Fabric	45070	45071	-	-	45073
Leatherette	-	-	45075	45076	45079

\*Available in 30 days. Minimum order 12 pieces.  
Select colour on [www.gimality.com](http://www.gimality.com) and indicate with order

Weight	Backrest height	Seat height	Width	Depth
12 kg	98/111 cm	45/52 cm	56 cm	49 cm



45083

45081

45082

45083

MADE IN ITALY

45082

Superior quality chair with neat lines, upholstered seat and backrest for greater comfort, swivel base, armrests, permanent contact movement of the backrest.  
High density foam.  
UNI EN 1335/1/2/3. Maximum load: 110 kg.

CREMONA CHAIR with armrest			
	Red	Grey	Blue
Fabric	45083	45081	45082

Weight	Backrest height	Seat height	Width	Depth
12 kg	90/107 cm	45/52 cm	58 cm	44 cm



45096

45091

45095

45092

45096

MADE IN ITALY

45091

Quality chair with upholstered seat and backrest, permanent contact movement of backrest and swivel base.  
Maximum load: 110 kg.  
UNI EN 1335/1/2/3.

VARESE CHAIR without armrest		
	Red	Blue
Fabric	45091	45092

VARESE CHAIR with armrest		
	Red	Blue
Fabric	45095	45096

Weight	Backrest height	Seat height	Width	Depth
11.6 kg	94/112 cm	46/59 cm	60 cm	47 cm

## VISITOR CHAIRS



45030

45030

45032

45036

45035

MADE IN ITALY

45030

- 45030 ISO - fabric - red
- 45032 ISO - fabric - blue
- 45035 ISO - leatherette - black
- 45036 ISO - leatherette - blue

Comfortable upholstered chair with 4 legged frame.  
Can be used for patient and waiting rooms, with Cuneo, Cremona and Varese chairs.  
Comfortable seat made of expanded polyurethane hit injected heliocell foams.  
Maximum load: 110 kg.

Weight	Backrest height	Seat height	Width	Depth
7 kg	82 cm	45 cm	53 cm	43 cm

## EXECUTIVE CHAIRS



45111

45110

Back reclines from 0 to 30°

45110

- 45110 SIDNEY EXECUTIVE CHAIR  
Stylish and comfort executive chairs with bracket to adjust height and back. Interwoven mesh cloth, skin friendly, smooth, breathable and easy to clean with plastic armrests.  
Chair base Ø 58 cm with chromed plated frame. Five nylon 360° rotating castors.
- 45111 SIDNEY VISITOR CANTILEVER  
Soft and comfortable foam seat.  
Back made of durable mesh, breathable fabric.

GIMA code	Backrest size	Seat height	Width	Depth
45110	49x48 cm	45/55 cm	48 cm	50 cm
45111	-	-	47 cm	43 cm



45124

45136

45128

MADE IN ITALY

45128

Maximum load: 110 kg

**ELITE EXECUTIVE CHAIR**  
Executive low-backed or high-backed armchair. Fabric or leatherette.  
Steel and chrome plated base and arms.  
Height adjustable by gas pump.

ELITE low-backed chair - 83-93 cm				
	Red	Black	Beige	Any colour*
Fabric	45124	-	-	45126
Leatherette	-	45127	45128	45132

ELITE PLUS high-backed chair - 101-111 cm				
	Red	Black	Beige	Any colour*
Leatherette	-	45136	-	45140

\*Available in 30 days. Minimum order 4 pieces.  
Select colour on [www.gimality.com](http://www.gimality.com) and indicate with order

Weight	Backrest height**	Seat height	Width	Depth
15 or 16 kg***	83/93 cm	39/49 cm	51 cm	45 cm

\*\*Low-backed chair \*\*\*Low-backed 15 kg, high-backed 16 kg

## X-RAY ILLUMINATORS - LIGHT BOXES



### X-RAY ILLUMINATORS

GIMA light boxes are designed according to clinical standards for an extra white light for an accurate and precise reading of any detail. They incorporate a 3 mm acrylic screen compliant with safety norms (fuses, Schuko plug, green light On/Off, ...). Can be used on the table placed horizontally or vertically, depending on model or wall mounted. Body made of oven-fired epoxy powder coated aluminium and injected ABS (colour RAL 7035).

#### TECHNICAL SPECIFICATIONS

Colour temperature: Cool white 6,500 °K  
 Power supply: 230 V - 50 Hz (60 Hz available with surcharge)  
 Protection fuse: 2x1A  
 Bipolar light switch  
 Schuko plug with 2 m cable  
 All components UL, DVE, IMQ approved



GIMA code	X-RAY ILLUMINATORS - LIGHT BOXES	External dimensions (cm)				Types
		Length	Height	Depth	Weight	
27364	Light box 38x38 cm	43	43	12	6	1 panel
27365	Light box 38x62 cm	67	43	12	8	1,5 panel
27366	Light box 38x92 cm	97	43	12	11	2 panels
27367	Light box 38x122 cm	127	43	12	14	3 panels
27368	Light box 38x153 cm	158	43	12	18	4 panels
27369	Light box 76x122 cm	127	2x43	12	28	2x3 panels
27370	Light box 76x153 cm	158	2x43	12	36	2x4 panels
27372	Light box 92x38 cm	43	97	12	11	2 panels vertical
27373	Light box 122x38 cm	43	127	12	14	3 panels vertical
27378	Neon tube for 27364					
27379	Neon tube for 27366, 27372					
27388	Neon tube for 27365					

## VALUE FOR MONEY LIGHT BOXES

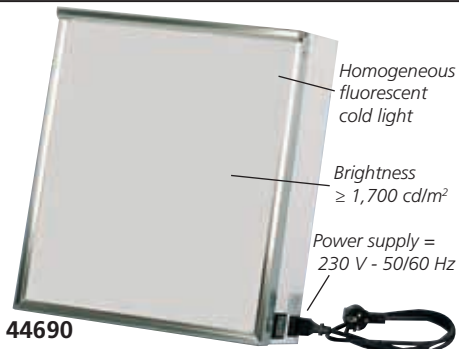

GIMA X-ray illuminators have been designed according to clinical recommendations for an extra white light to give an accurate and precise reading of any detail. Made of enamelled sheet steel. Unbreakable white monochromatic diffuser, stainless steel gripping system. On/off switch for separate use of each panel for 44692.

MADE IN ITALY

GIMA code	X-RAY ILLUMINATORS - LIGHT BOXES	External dimensions (cm)				Types
		Length	Height	Depth	Weight	
44690	40x43 cm	43	46	14	6	1 panel
44692	80x43 cm	83	46	14	10	2 panels
44695	Round fluorescent light 32 W - spare					

## ILLUMINATED AND NOT ILLUMINATED OPTOMETRIC CHARTS

MADE IN ITALY



GIMA luminous optotypes have been designed according to clinical recommendations for an extra white light to give an accurate and precise reading of any detail. Manufactured with acrylic screen, and according to safety norms (fuses, Schuko plug, green light On/Off,...)



OPTOMETRIC CHARTS	Illuminated GIMA code	Not illuminated GIMA code
Armagnac - 5 m	27380	27390
Monoyer - 3 m	27381	27391
Mixed decimal - 3m	27382*	27392*
Children - 3 m	27383	27393
Animals - 5 m	27384	-
Spare Tube 700	27388	-

#### TECHNICAL SPECIFICATIONS

Viewing Area: 24 x 62 cm    24 x 61 cm  
 External dimensions: 29.5x67.5x12 cm    29 x 66 x 2.5 cm  
 Weight: 6 kg    2 kg  
 Power supply: 230 V - 50 Hz (60 Hz on request) only 27380-4  
 Other specifications like X-ray illuminators 27364-72

- MONOYER**  
3m  
• 27381
- MIXED DECIMAL**  
3m  
• 27382\*
- ARMAGNAC**  
5m  
• 27380
- CHILDREN**  
3m  
• 27383
- ANIMALS**  
5m  
• 27384

\*Not suitable for Portugal

See economic optometric charts at page 273

# LED ULTRA SLIM X-RAY ILLUMINATORS - DESKTOP AND WALL

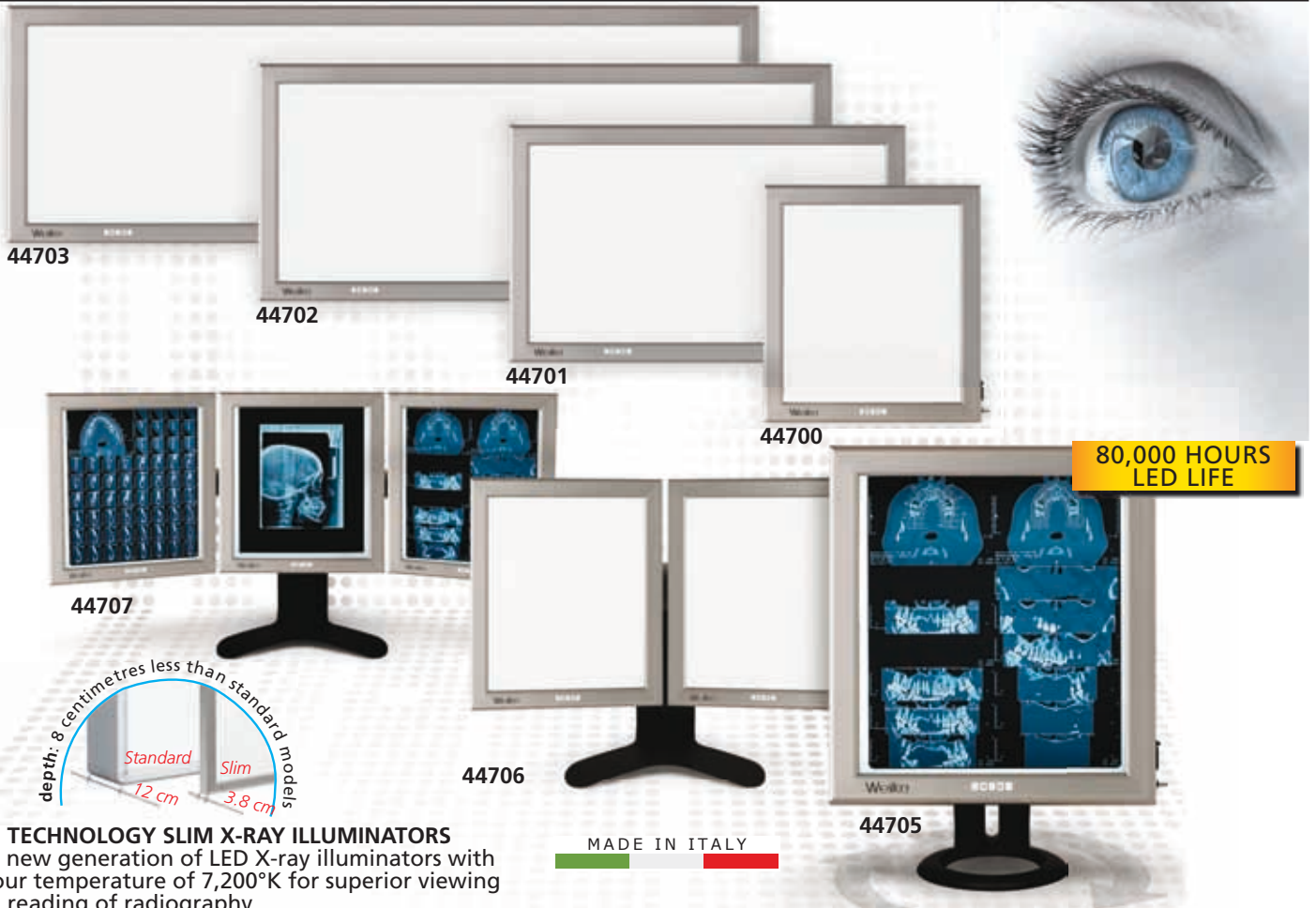

## LED TECHNOLOGY SLIM X-RAY ILLUMINATORS

The new generation of LED X-ray illuminators with colour temperature of 7,200°K for superior viewing and reading of radiography. Complete elimination of light flickering and 5,000 cd/mq luminance for more uniform light diffusion. Frame in antiscratch anodized aluminium. Film gripping system incorporated. Dimmer for luminance adjustment from 30% to 100%.  
 - FAS: automatic switching on/off at the positioning/removal of the film.  
 Economic advantages:  
 - LED life 80,000 hours, with low maintenance costs  
 - low energy consumption compliant with European law  
 Double support for horizontal or vertical wall mounting or desktop.

### Fully adjustable desktop model:

- Position of panel can be totally adjusted:
- height adjustment 13 cm
- inclination 35° (+25°/-5°)
- vertical or horizontal positioning (44705 only)
- horizontal rotation 10° (270° for 44705 only)

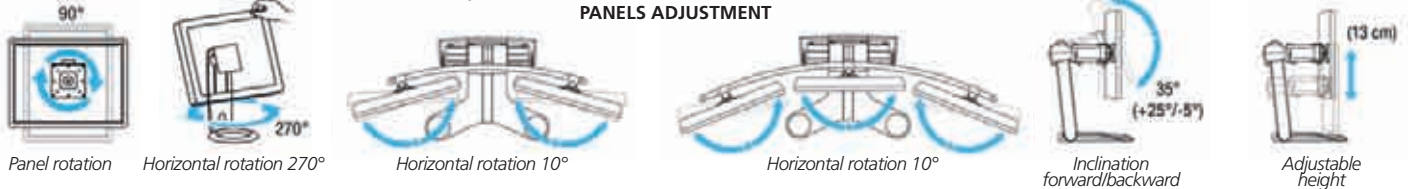

## LED ULTRA SLIM OPTOMETRIC CHARTS

LED ULTRA SLIM OPTOMETRIC CHARTS  
 New generation of optometric charts with same specifications as above X-ray illuminators.

LED ULTRA SLIM OPTOMETRIC CHARTS - WALL			
GIMA code		Viewing area	External size
44710	Armagnac - 5 m	25.5x63 cm	34x72x3.8 cm
44711	Monoyer - 3 m	25.5x63 cm	34x72x3.8 cm
44712	Mixed decimal - 3m	25.5x63 cm	34x72x3.8 cm
44713	Children - 3 m	25.5x63 cm	34x72x3.8 cm



GIMA code	WALL LED SLIM VIEWERS viewing area	External size - cm			Weight kg	Switches	Types
		Length	Height	Depth			
44700	Light box 42x36 cm	46	50.5	3.8	4	1	■ 1 panel
44701	Light box 42x72 cm	82	50.5	3.8	8	1	■ 2 panels
44702	Light box 42x108 cm	118	50.5	3.8	12	1	■ 3 panels
44703	Light box 42x144 cm	154	50.5	3.8	16	1	■ 4 panels

GIMA code	DESKTOP LED SLIM VIEWERS viewing area	External size - cm			Weight kg	Switches	Types
		Length	Height	Depth			
44705	Light box 42x36 cm x1	46x1	50.5	3.8	6	1	■ 1 panel
44706	Light box 42x36 cm x2	46x2	50.5	3.8	20	2	■ 2 panels
44707	Light box 42x36 cm x3	46x3	50.5	3.8	26	3	■ 3 panels

**TECHNICAL SPECIFICATIONS**  
 Colour temperature: Cool white 7,200°K  
 Power supply: 110-230 V - 50/60 Hz  
 Conformity to Low Voltage Directive 2014/35/CE  
 Conformity to Electro Magnetic compatibility 2014/30/CE  
 Conformity to EEC directive 2007/47 medical Device Class I  
 All components UL, DVE, IMQ approved  
 Brightness: 5,000 cd/m<sup>2</sup>  
 LED life: 80,000 hours

### PANELS ADJUSTMENT

## HEATING BLANKETS



28660

- **28660 HEATING UNDERBLANKET - single**
- **28661 HEATING UNDERBLANKET - double**

Electric underblankets made of non-woven fabric (polyester) with stamp welding manufacturing. They warm and relax the entire body, night and day. 3 temperature settings with level indicator. Double underblanket (28661) has 2 controllers. Detachable hand controller allows to wash the blanket. Overheating protection. Supplied with multilingual box and manual GB, FR, IT, DE, NL, PT, GR, SE, PL, RO, FI, CZ.

**TECHNICAL SPECIFICATIONS**

	28660	28661	28664
Size (cm):	150x80	160x140	160x120
Power consumption:	60 W	2x60 W	120 W
Voltage:	220-240 V		



28664

- **28664 HEATING OVER BLANKET**

Electric over blanket made of soft micro plush provides warmth and comfort night and day. 3 temperature setting with LED indicator (0, 1, 2, 3). Automatic switch off after 3 hours. Detachable hand controller allows to wash the blanket. Fast heating and overheating protection. Supplied with multilingual box and manual GB, FR, IT, DE, NL, PT, GR, SE, PL, RO, FI, CZ.

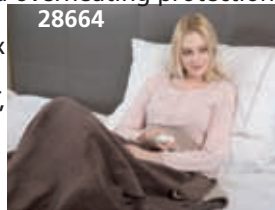

28664

## FOOT WARMER



28668

- **28668 FOOT WARMER WITH MASSAGE**

Comfortable foot warmer made of super cozy fleece surface and liner. Two motor vibration. Two heat settings. High and low massage intensities. Removable and washable liner. Supplied with multilingual box and manual: GB, FR, IT, DE, NL, PT, GR, SE, PL, RO, FI, CZ.



**TECHNICAL SPECIFICATIONS**

Size:	30x30x24 cm
Power consump.:	18 W
Voltage:	220-240 V

## HEATING PADS FOR MUSCLE AND PAIN RELIEFS



28670

- **28670 HEATING PAD WITHOUT COVER**
- **28671 HEATING PAD WITH COVER**

Super cozy fleece pads with or without cover. Temperature settings with level indicator: 3 settings (28670) or 6 (28671). Automatic switch off after 90 minutes. Detachable hand controller allows to wash the pad. Fast heating and overheating protection. Supplied with multilingual box and manual GB, FR, IT, DE, NL, PT, GR, SE, PL, RO, FI, CZ.



28671

**TECHNICAL SPECIFICATIONS**

Size:	40x30 cm (28670), 63x42 cm (28671),
Power consump.:	100 W
Voltage:	220-240 V



28670



28674

- **28674 NECK AND SHOULDER HEATING PAD**

Heating pad for neck and shoulder made of micro plush surface. Individually adjustable by press stud. 3 temperature settings with level indicator. Automatic switch off after 90 minutes. Detachable hand controller allows to wash the pad. Fast heating and overheating protection. Supplied with multilingual box and manual: GB, FR, IT, DE, NL, PT, GR, SE, PL, RO, FI, CZ.

**TECHNICAL SPECIFICATIONS**

Size:	60x62 cm
Power consumption:	100 W
Voltage:	220-240 V



28674



28675

- **28675 WAIST WRAP HEATING PAD**

Waist heating pad made of super cozy fleece surface with stamp welding manufacturing. 3 temperature settings with level indicator. Automatic switch off after 90 minutes. Detachable hand controller allows to wash the pad. Fast heating and overheating protection. Supplied with multilingual box and manual: GB, FR, IT, DE, NL, PT, GR, SE, PL, RO, FI, CZ.

**TECHNICAL SPECIFICATIONS**

Size:	29x69 cm
Power consumption:	100 W
Voltage:	220-240 V



28675

## HOT-COLD GEL

Individually packed in single box

34114



• **34114 HOT-COLD THERMO GEL - box of 30 pcs.**  
Special gel keeps temperature (hot or cold) for long time. Size: 14x28 cm. Multilingual box and instructions: GB, FR, IT, ES, PT, DE, GR.

## HOT WATER BOTTLES

Capacity 2,000 cc

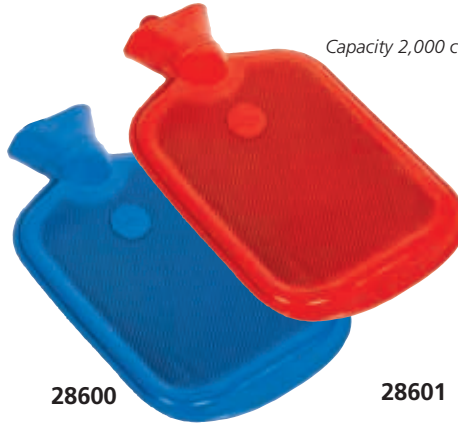

28600

28601

• **28600 HOT WATER BOTTLE 2 l - British standard - blue**  
55% made of rubber.  
• **28601 HOT WATER BOTTLE 2 l - red**  
25% made of rubber.  
Both are two side ribbed.  
Packed in plastic bag with multilingual user manual (GB, FR, IT, DE, ES, PT, GR).

## ICE BAGS

Both made of polyester fabric + PVC.



28605

28606

• **28605 ICE BAG - Ø 28 cm - large top cap - light blue**  
Cap Ø: external 8.78 cm, internal 6 cm  
Single packed in carton box, with multilingual manual (GB, FR, IT, PL, ES, PT, GR, Arabic).  
• **28606 ICE BAG - Ø 28 cm - small top cap - blue**  
Cap Ø: external 7.15 cm, internal 4.7 cm  
Transparent bag with multilingual manual (GB, FR, IT, DE, ES, PT, GR).

## INFRARED THERAPY LAMP - 250 W

- **28652 INFRARED THERAPY LAMP - 250 W - desk with table clamp**
- **28653 INFRARED THERAPY LAMP - 250 W - trolley**

The infrared light relieves the suffering caused by sore muscles and joints ankylosis. The comfortable warmth created by infrared light penetrates deep into the skin, stimulates blood circulation and warms the muscles.

While the muscles are relieved, they automatically stretch and relax. At the same time, the blood circulation helps your body get rid of impurities and quickly sends oxygen-rich blood to stressed or aching muscles, causing an effective pain relief.

- **28654 SPARE BULB - 250 W**

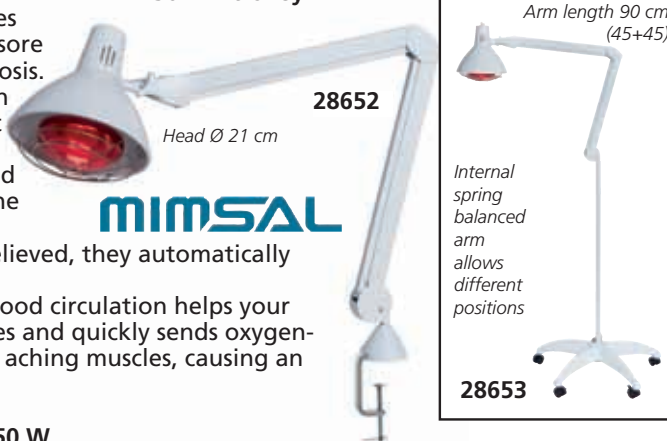

28652

28653

## INFRARED LAMP

- **28646 MOMERT INFRARED LAMP 150 W**

The lamp's deep penetrating infrared heat relaxes the muscles and stimulates the blood circulation.

The pleasant heat expands the capillary veins, resulting in a better oxygen and nutrition supply to the tissues. Can be used for rheumatic diseases, allergies, cold diseases, alternative medicine (detoxication), beauty care. Operating voltage: 230 V - 50 Hz.

- **28647 SPARE BULB - 150 W Philips**



Multilingual manual and box (GB, IT, DE, HU, SK, HR, CZ, EE, PL, RU, RO).

## I-TECH LA 500 LASER THERAPY

- **28410 I-TECH LA 500 LASER THERAPY**

Laser therapy device equipped with a new probe with an emitting diode that allows beam laser application directly to the treatment area.

I-TECH LA 500 is able to stimulate deep tissues by promoting a rapid cellular regeneration thanks to 500 mW power output and 810 nm wavelength. Professional user can adjust power output, therapy time and operation mode (continuous or pulse). I-TECH LA 500 guarantees a fast intervention for the treatment of inflammatory and degenerative pathologies in orthopedic, neurologic and dermatologic area.

Thanks to its high performance healing time is significantly reduced. Supplied with probe, belts for probe fastening and safety glasses. Manual in: GB, IT, FR, ES, DE.

### LASER THERAPY

The laser therapy uses the effects of energy produced by the light source penetration into the tissues.

Biochemical reactions are activated across the cellular membrane. It has been observed that right doses of Laser light can stimulate cellular functions, in particular into the cells damaged by functional deficits.

The main effects of Laser therapy are:

- improved blood flow: capillary and artery vasodilatation that results in local heat increase
- biostimulation: accelerated tissues repair, stimulation of protein synthesis, ADP production, electrolyte changes in the intra- and extra-cellular fluids and mitosis of fibroblasts, increase of collagen and elastin
- anti-inflammatory effect
- anti-oedema effect: lymphatic drainage stimulation
- analgesic effect



28410

### TECHNICAL SPECIFICATIONS

- |  |  |
|--|--|
| Power supply: 230 V, 50-60 Hz, ±10%    | Fixed width duration                   |
| Maximum laser output: 500 mW ± 20%     | Continuous or pulse mode of operation  |
| Adjustable laser power output: 0%-100% | Pointing red light                     |
| Laser diode wavelength: 810 nm         | Diode probe (with reserved connection) |
| Beam divergence angle: 260 mrad        | Adjustable therapy time: 0-30 minutes  |
| Continuous output emission             | Diameter of laser beam: <10 mm         |
| Fixed emission frequency               | Dimensions: 300x150x120 mm             |

### MAIN TREATMENTS

- Polyarthritis - Epicondylitis/Epitrochleitis - Knee pain - Myositis
- Oedema - Sciatalgy/Lumbago - Articular sprains - Chronic Tenosynovitis - Muscle strains - Overcharge pathologies - Echymosis - Bursitis - Degenerative arthritis - Adhesive capsulitis - Arthrosis pains - Post-traumatic disorders
- Scars - Rheumatic diseases

# AIR COMPRESSION THERAPY SOLUTIONS

Human body has a peripheral circulation of blood and lymph. Air compression therapy is an automatic drainage and circulation system which helps patients to recover from their disease by improving blood and lymph circulation and metabolism. It consists of air chambers and an air pump offering air compression massage to legs, arms or waist.

### Medical indications (only 28441)

- DVT (Deep Vein Thrombosis)
- Lymph edema
- Post-paralytic
- Limb convulsion
- Phlebosclerosis
- Chronic venous insufficiency (CVI)
- Post-mastectomy
- Post-trauma
- Spinal cord injury
- Varicose veins
- Sciatica
- Diabetes
- Sprains
- Arterial insufficiency

### Home care indications

- Lymph edema
- Diseases caused by interrupted blood circulation
- Cellulitis fat dissolution
- Pregnant woman's limb treat.
- Numb feet or hands
- Cold feet or hands
- Settlement of stress
- Exercise effects
- Insomnia
- Healthier body and elastic skin
- Old age, weakness and fatigue

**HELP BLOOD CIRCULATION**

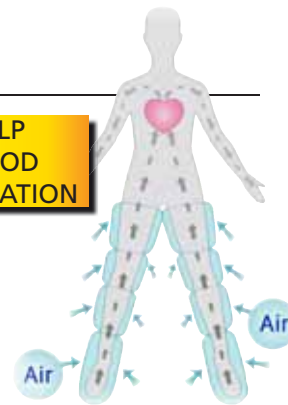

## ANYCARE DIGITAL COMPRESSION MASSAGE

• **28415 ANYCARE DIGITAL COMPRESSION MASSAGE - LEG A**  
 • **28416 ANYCARE DIGITAL COMPRESSION MASSAGE - LEG B**  
 Pressure intensity and time can be adjusted according to user's needs. Individual chambers pressure testing. Portable and easy operation. For homecare use. Supplied with 2 legs A (74x62 cm) or B (79x75 cm) 4 chambers, 1 double hose and 2 plastic feet guides, multilingual manual (GB, FR, IT, ES).

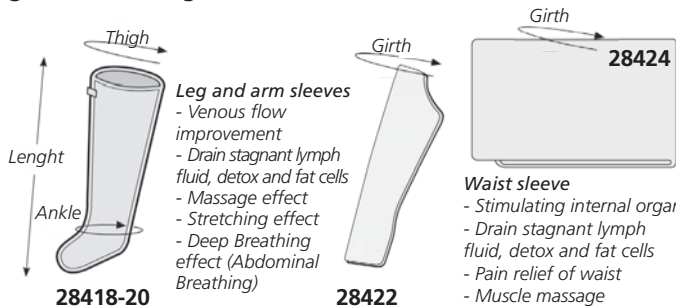

Power consumption: 32 W (40 VA) +10%  
 Voltage: AC 220V - 50-60 Hz

Timer Range: 0-30 minutes



ACCESSORIES FOR ANYCARE AND MAYLEA						
New*	Old**	LEG SLEEVES	Patient height	Thigh	Ankle	Length
28418	-	Leg sleeve A	160-170 cm	62 cm	41 cm	74 cm
28419	-	Leg sleeve B	170-180 cm	75 cm	43 cm	79 cm
28420	-	Leg sleeve C	> 180 cm	76 cm	46 cm	94 cm
ARM - WAIST SLEEVES				Girth	Length	
28422	28436	Arm sleeve		50 cm	88 cm	
28424	28437	Waist sleeve		122 cm	38 cm	
HOSES						
28426	-	Single hose to connect one sleeve				
28427	28440	Double hose to connect two sleeves				
28428	-	Distribution hose to connect three sleeves - needs 28426+28427				

\*New sleeves can be used only with Anycare standard hose or codes 28426-8  
 \*\*Old sleeves can be used only with Maylea standard hose or 28440

## MK400L PROFESSIONAL COMPRESSION SYSTEM

• **28441 MK400L PROFESSIONAL COMPRESSION SYSTEM with 2 legs (XL), and 2 single hoses**  
 MK400L is a professional air compression therapy system with essential functions for different kinds of patients. This system provides 3 compression modes (wave, squeezing, double squeezing), reverse compression settings, skip functions to select directly part to be pressurized and compression speed controller. Touch key pad display. Manual: GB, IT, ES.

### TECHNICAL SPECIFICATIONS

- Pressure range: 10-200 mmHg
- Use time: 1-90 minutes
- Automatic pressure detection
- Body size: 415x310x160 mm
- Operating voltage: 220-240 V, 50/60 Hz, 50 VA
- Body weight: 6.5 kg

You can use 2 cuffs at the same time, MK400 has 2 connection plugs



28441

2 hose plugs connections

**PROFESSIONAL AIR COMPRESSION SYSTEM**

- **28442 LEG CUFF L - 6 CHAMBERS - spare**
- **28443 LEG CUFF XL - 6 CHAMBERS - spare**
- **28444 LEG EXTENSION ZIPPER XL - 10 cm extra extension for 28443**
- **28445 SINGLE HOSE - spare**
- **28446 ARM CUFF - 6 CHAMBERS - universal**
- **28447 WAIST CUFF - 6 CHAMBERS - min-max girth 94-125 cm**

**A mode (Wave)**  
 The selected air chamber inflates and deflates by one chamber sequentially from foot up to thigh.

**B mode (Squeezing)**  
 After all the selected air chambers inflate sequentially from foot up to thigh the inflated chambers deflate at once.

**C mode (B mode two times + Reverse A mode 1 time)**  
 The selected air chambers inflate and deflate by two chambers sequentially from foot up to thigh.

**Reverse setting:** it allows to change automatically the selected mode to reverse mode.

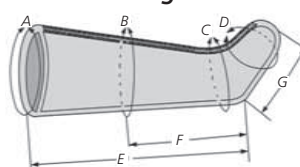

Cuff Size	Leg dimension (cm)						
	A	B	C	D	E	F	G
L	64,0	49,5	40,5	34,5	75,0	38,0	28,0
XL	73,5	55,0	42,0	35,5	85,0	43,0	31,0



# CR200 - PROFESSIONAL TECAR THERAPY

• **28364 CR200 TECAR THERAPY with 2 probes**  
 Diathermy, also known as TECAR Therapy (meaning Capacitive and Resistive Energy Transfer), is a therapy stimulating the physiological healing process by accelerating the recovery time of motor function. Diathermy stimulates tissues endogenous heat production through the interaction of electromagnetic field and tissue. The heat is increased in a uniform controlled way. The electromagnetic interaction results in a ionic flow and consequently increases blood flow in the treated area. This process stimulates endogenous substances release (in particular cortisol and endorphins) that are necessary to reduce inflammations, pain and edemas. The new CR200 resistive capacitive diathermy is a modern and highly performing device easy to use by professionals. Preset programmes help use the device from the start. Moreover the device can set parameters (power, time therapy, capacitive/resistive modes) according to therapeutic needs. It allows the memorization of customized programmes. In this way patient protocols are easily consulted by therapists at any time. Equipped with a wide graphic display showing therapy parameters and different working modes. Selectable software language (GB, IT, ES).

- **28361 RESISTIVE PROBE - spare**
- **28362 CAPACITIVE PROBE - spare**

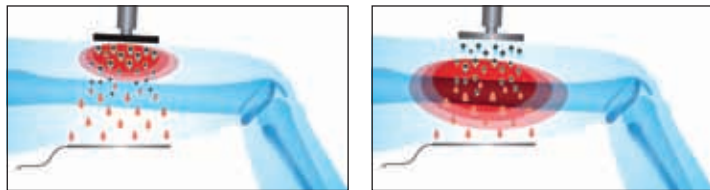

**Capacitive mode**  
 Electrode coated with ceramic material (mobile) and return plate (fixed). Indicated especially for soft tissues (muscle mass and lymphatic/vascular system). Benefits: specific intervention, easy control of the treated area.

**Resistive mode**  
 Non isolated electrode (mobile) and return plate (fixed). Indicated especially for tissues with greater resistance (bones, joints, tendons, ligaments, cartilages). Benefits: high level of diathermy; chronic diseases with fibrosis and degeneration

### STANDARD ACCESSORIES

- 2 multi-function probes for capacitive and resistive mode
- 2 electrodes Ø 35 mm (1 resistive + 1 capacitive) with 9.61 cm<sup>2</sup> effective working area
- 2 electrodes Ø 60 mm (1 resistive + 1 capacitive) with 28.26 cm<sup>2</sup> effective working area
- 2 integrated supports for probes
- 1 steel plate
- Bottle of conductive cream 1 kg
- Power supply cable
- User Manual: GB, IT (ES, FR on request)



### MAIN TREATMENTS

- |   |  |
|---|--|
| Skeletal-muscle pathologies<br>Lymphedema   | Acute and chronic pain<br>Osteoarticular pathologies   |
| <b>24 REHAB PROGRAMMES</b><br>Phantom limb, knee arthrosis, arthrosynovitis, bursitis, neck pain, whiplash syndrome, chondropathy, muscle contracture, contusion, muscular sprain, sprain, muscle distraction, joint pain, edema, epicondylitis, epitrochleitis, anterior cruciate ligament, lymphedema, low back pain, meniscopathy, | muscle tear, acute tendinitis, chronic tendinitis, rotator cuff tendinopathy   |
|   | <b>10 SPORT PROGRAMMES</b><br>muscle contracture, contusion, muscle recovery, sprain, hematoma, tendon injury, superficial massage, deep massage, muscle sprain, muscle tear |
|   | <b>10 FREE MEMORIES</b>  |

### TECHNICAL SPECIFICATIONS

- Power supply: 100-240 V, 50/60 Hz
- Max power consumption: 160 W (100 ohm load)
- Carrier frequency: 500 kHz
- Adjustable power: 0-100%
- Touch screen graphic display 7"
- Preset programmes, free memories

# CONDUCTIVE CREAMS

- **28345 DIATER CONDUCTIVE CREAM 1 l - neutral base**
- **28346 DIATER CONDUCTIVE CREAM 1 l - arnica**
- **28347 DIATER CONDUCTIVE CREAM 1 l - hyaluronic acid**

Essential, simple and effective conductive creams. Rich in active ingredients which are recognized in musculoskeletal therapies, in support of the functional recovery of athletes and in the aesthetic treatments of epidermis and dermis. Exceptional absorption and therapies enhancement keep the activity focused on the portion of treated tissue, with marked stability and effectiveness. Absence of parabens or petrolatum. **Neutral base conductive cream** moisturizes and protects tissue; suitable for mixes and cocktails. **Arnica Montana conductive cream** decongests and protects tissue. For acute and chronic inflammation of tissues or joints and Lipodystrophy. **Hyaluronic acid conductive cream** for hydro balancing of the tissues. Protective of cartilage and against phlegm and tissue trauma spills. Treatment of scars, hypotonia and post-surgery outcomes. Suitable for passive mobilizations. Creams are preserved into thermo/photo protected PET containers with cap and undercap and dispenser. For professional use only in different fields: Physiotherapy, Physiatry, Plastic Surgeons, Aesthetics, Orthodermic therapy,

Athletic Preparation, Massage and Podiatry  
 Label in: GB, IT, FR, ES.

- **28348 ADAPTOR CAP WITH DOSING PUMP**



## MIO-SONIC ULTRASOUND THERAPY DEVICE - 9 PROGRAMS

### • 28309 MIO-SONIC ULTRASOUND THERAPY

Innovative and high performance device both for home use and professional use. Suitable for muscle contractures and joints stiffness. It combines compactness and high performances in a small, light and easy to use applicator. The lightness and handiness allows a continuous use without any difficulty. Mio Sonic can be used for the following applications:

- pain therapy;
- sport injuries;
- aesthetic treatments.

Supplied with gel bottle, carrying and storage bag, medical power supply and multilingual manual: GB, FR, IT, ES. On request DE.



28309

#### TECHNICAL SPECIFICATIONS

9 programs;  
 1 MHz ultrasound, maximum output power 6.4 W, maximum intensity 1.6 W/cm<sup>2</sup>;  
 Collimated ultrasound beam for an optimal penetration beam;  
 3 ultrasound beam intensity levels 0,08 W/cm<sup>2</sup> (low) - 0,8 W/cm<sup>2</sup> (medium) - 1,6 W/cm<sup>2</sup> (high);  
 Power supply: 100-240V, 50/60 Hz  
 Direct contact device (not suitable for water immersion)  
 Size-weight: 200x47x69 mm - 190 g

#### TREATMENTS

Osteoporosis	Periarthritis	Adhesions	Muscular contractures	Arms cavitation
Arthritis	Tendinitis	Algodystrophy	Cramps	Abdomen cavitation
Neuralgias	Pubalgia	Bursitis	Massage	Limb cavitation
Cervicalgias	Tallonitis	Brachialgy	Drainage	Gluteus cavitation
Sciatalgy	Contusions	Capsulitis	Modelling	Lumbalgy
Sprains	Chondropathy	Stretch marks	Carpal Tunnel	Hematoma
Cruralgy	Microlifting	Epycondilitis	Oedema	Acne
Wrinkles	Epitrochleitis	Lymphedema	Venous stagnation	Phonophoresis

## I-TECH UT2 - PROFESSIONAL ULTRASOUND THERAPY



• 28358 I-TECH UT2 ULTRASOUND THERAPY - 2 probes  
 Professional ultrasound device equipped with 2 handles respectively with 5 cm<sup>2</sup> and 1 cm<sup>2</sup> probe. Its equipment and parameters setting allow high performance suitable for professional users.

It is provided with 10 preset programmes within which professional user can adjust following parameters:

- Frequency (1 or 3 MHz)
- Effective intensity (up to 3 W/cm<sup>2</sup>)
- Duty cycle (10%÷100% stepping 10)
- Therapy time (up to 30 minutes)

#### TECHNICAL SPECIFICATIONS

Operating voltage: 100-240 V, 47/63 Hz, 1.35A, output 15V 3A max  
 Ultrasound frequency: 1 MHz ± 10% and 3 MHz ± 10%  
 Output power: 0.5-10 W ± 20% when duty cycle ≥ 80% for 5 cm<sup>2</sup> ultrasound head  
 0.5-15 W ± 20% when duty cycle ≤ 70% for 5 cm<sup>2</sup> ultrasound head  
 0.1-2 W ± 20% when duty cycle ≥ 80% for 1 cm<sup>2</sup> ultrasound head  
 0.1-3 W ± 20% when duty cycle ≤ 70% for 1 cm<sup>2</sup> ultrasound head  
 Max Power: 3 W/cm<sup>2</sup> ± 20% (1 MHz); 3 W/cm<sup>2</sup> ± 20% (3 MHz)  
 Working frequency: 100 Hz  
 Duty cycle: 10%-100% stepping 10%  
 Maximum adjustable therapy time 30 minutes  
 Effective radiating area 5 cm<sup>2</sup> ± 20%; 1 cm<sup>2</sup> ± 20%  
 Collimated beam type Ultrasound head (material) aluminium  
 Direct contact and water immersion use  
 Led indicator Size: 250x185x82 mm

#### APPLICATIONS

Tendinitis - Bursitis/Capsulitis - Hematomas and tissue reconstruction -  
 Muscle contractures/Cramps - Neuralgias - Periarthritis - Cervicalgias -  
 Sciatalgy/Lumbalgy - Carpal tunnel syndrome - Epicondylitis/epitrochleitis -  
 Contusions/sprains - Chondropathy - Massage - Arms/abdomen/legs/gluteus  
 cavitation - Acne

#### STANDARD ACCESSORIES

- |                                       |  |
|---------------------------------------|--|
| 1 handle with 5 cm <sup>2</sup> probe | 1 power supply 15 V, 3 A                   |
| 1 handle with 1 cm <sup>2</sup> probe | 1 ultrasound gel                           |
| 1 power supply cable                  | User manual: GB, IT, ES, FR. DE on request |

## IONO BASE PLUS - GALVANIC IONOPHORESIS

### • 28306 IONO BASE - PLUS - 2 channels

Local administration of medicines by ionophoretics, electric osmosis and treatment of hyper hydrosis (sweating disease) and cellulitis. Current generator for hydro galvanization, aesthetic shaping and against cellulitis slight blemish.

Microprocessor controlled, with selection of parameters and internal programs. Simple and safe to use, although it maintains characteristics of a professional equipment.

### • 28335 RUBBER ELECTRODES 50x50 mm - box of 10

### • 28336 SPONGE BAGS for electrodes 50x50 mm - box of 10

Supplied with ABS case, velcro elastic bands, rubber conductive electrodes 80x120 mm and 50x50 mm and envelopes sponges for electrodes.  
 MADE IN ITALY



**TECHNICAL SPECIFICATIONS**  
 Operating Voltage: 230 V - 50/60 Hz  
 Absorbed Max Power: 10 VA  
 Safety class: II BF - C E 93/42/EEC.  
 Size: 138x68x193 mm  
 Max Output Current: 20 mA

## T-ONE COACH AND T-ONE MEDI SPORT - 4 CHANNELS ELECTROTHERAPY

**• 28401 T-ONE COACH ELECTROTHERAPY - 4 channels**  
A high performant muscle stimulator designed to improve physical activity. Easy to use programs ideal device for not professional athletes and for sports lovers. It is not only a muscle stimulator equipment. It is supplied by TENS protocols for pain relief and injuries recovery.

**• 28402 T-ONE MEDISPORT ELECTROTHERAPY - 4 channels**  
Professional equipment specifically designed for sport specialist users. Muscle stimulation specialized programs improve sport performance. It increases strength and helps recovery of sport injuries with specific treatment protocols.

**Main features**

- constant current generator (can guarantee a constant current even when skin condition changes, the device automatically stops in the event of accidental electrodes disconnection)
- four independent channels unit (up to 8 connectable electrodes)
- compensated biphasic square wave: current quantity from positive pole to negative one is constant to avoid polarization effect;
- monophasic wave generator (only for iontophoresis programs)
- 2+2 users programs
- backlight graphic colour display
- user feedback: the device recognizes patient connection
- soft-touch easy to use keyboard
- on-line 5 languages guide (GB, FR, IT, ES, DE) on display
- 4,8 V rechargeable battery pack
- personalized programs for man and woman
- maximum intensity 240 mApp, with 1 mA step regulation

Size: 150x90x35 mm



- 28351 PRE GELLED ELECTRODES 40x40 cm with cable - box of 4
- 28373 PRE GELLED ELECTRODES 45x80 cm with cable - box of 4
- 28381 IONOPHORESIS KIT - spare (1 elastic band, 2 silicone conductive electrodes, 2 sponges)
- 28403 Ni-Mh BATTERY 4.8 V 2300 mA for 28401, 28402

**STANDARD ACCESSORIES**

4 connection cables (8 connectable electrodes)  
Kit of pre-gelled self-adhesive electrodes (square, rectangular, round)  
Ionophoresis kit: elastic belt, 2 silicone electrodes, 2 sponges, carrying bag (28402 only)  
Internal Ni-Mh rechargeable battery pack and battery charger  
Electrode position manual and user manual (GB, FR, IT, ES). On request DE, PT

BEAUTY 18 programmes 28401 and 28402	REHA 10 programmes only 28402	TENS 16 programmes 28401 and 28402	NEMS 14 programmes 28401 and 28402	MEM Only 28402	2+2 28401 and 28402
Firming up Toning up Definition Modelling Microlifting Lipolysis abdomen Lipolysis thighs Lipolysis glutei and hips Lipolysis arms Tissue elasticity Capillarization Heaviness in legs Face Microlifting Handy Trode Breast Microlifting Handy Trode Décolleté Microlifting Handy Trode Face Wrinkles Handy Trode Forehead Wrinkles Handy Trode Collagen	Ionophoresis L Ionophoresis M Ionophoresis H MENS microcurrent Haematomas Oedema Tens sequential Tens Burst Atrophy prevention Atrophy	Tens rapid Tens endorphinic Tens max values Inflammatory Neck pain Backache/Sciatic pain Sprains/Bruises Vascularization Muscle relaxant Hand and wrist pain Plantar stimulation Epicondylitis Epitroclea Periarthritis Tens Burst Microcurrent	Warming up Resistance Resistance strength Basic strength Fast strength Explosive strength Deep capillarization Muscle recovery Agonist/Antagonist Sequential tonic contractions Sequential phasic contractions Muscle relaxant Deep massage EMS  <b>Only 28402</b> 30' Resistance 30' Resistance strength 20' Basic strength 20' Fast strength 20' Explosive strength 20' Hypertrophy	Tens mem 1 Tens mem 2 Tens mem 3 Tens mem 4 Tens mem 5 NEMS mem 1 NEMS mem 2 NEMS mem 3 NEMS mem 4 NEMS mem 5 NEMS alternated NEMS alternated Battery test	Tens rapid Tens endorphinic Firming up Toning up Definition Modelling Microlifting Muscle relaxant Massage Capillarization  <b>Only 28402</b> Inflammatory Resistance, Resistance strength Basic strength, Fast strength Explosive strength, Hypertrophy Face Microlifting Handy Trode Breast Microlifting Handy Trode Décolleté Microlifting Handy Trode Face Wrinkles Handy Trode Forehead Wrinkles Handy Trode

## GIMA UTC 2: COMBINED ULTRASOUND AND ELECTROTHERAPY UNIT

**• 28301 GIMA UTC 2 AUTOMATIC**  
Programmable driver unit for ultrasound transducers with working frequencies from 1 up to 3 MHz together with 2 channels of electrotherapeutic current. UTC 2 delivers continuous or modulated ultrasound with programmable intensity and delivery time, suitable for thermo therapeutic deep treatment of different pathologic conditions. Transducer handpieces can be used under water. UTC 2 delivers Dyadinamic, Faradic, Galvanic, Impulsive, T.E.N.S. and Bipolar electrotherapeutical currents.

- high brightness graphic touchscreen display
- controls of unit by multifunction knob, keys or touchscreen
- wide range of preset protocols
- customized programmes
- multi frequency handpieces
- automatic identification of the connected accessory
- continuous or pulsed delivery
- sequence of treatment phases planning for each channel
- independent channels
- safety control blocks the output current in case of accidental disconnection of electrodes.

- 28302 1-3 MHz ULTRASOUND HEAD Ø 15 mm
- 28303 CONNECTING CABLE for electrotherapy - spare
- 28304 CLIP RUBBER ELECTRODES 120x80 mm - box of 12
- 28305 CLIP RUBBER ELECTRODES 45x60 mm - box of 12
- 28323 VELCRO ELASTIC BAND 100x8 cm - spare



6 language software: GB, FR, IT, ES, DE, PT.

**TECHNICAL SPECIFICATIONS**

Output frequency (MHz): 1.0 to 3.0  
Max intensity (W/cm<sup>2</sup>): 3.0  
ET channels: 2  
Electrical input power (VA): 70  
Max output direct current (mA): 30  
Max output pulse current (mA): 70  
Max output voltage (Vdc): 100  
Power supply (Vac/Hz): 90-240 / 50-60

**STANDARD ACCESSORIES**

1-3 MHz ultrasound head Ø 35 mm  
Connecting cable for electrotherapy 1-2 (28303)  
4 rubber electrodes 120x80 mm; 4 rubber electrodes 45x60 mm  
3 velcro elastic belt: 8x40, 8x60, 8x100 cm Power cable 2 m

## ORTHOMAG LOW FREQUENCY MAGNETOTHERAPY - 2 PROGRAMMES

- Osteogenesis
- Biostimulation
- Pain management



28298

### • 28298 ORTHOMAG low frequency magnetotherapy kit

A professional low frequency magnetotherapy (PEMF) device that can be used everywhere. Lightweight, comfortable and flexible, fitting your body shape. Battery powered for dynamic use or power socket for use at home or in the office. Orthomag includes 2 programmes (75 Hz and 50 Hz) indicated for bone tissue pathologies, joint diseases and pain management. Up to 25 Gauss per programme. Supplied with rechargeable lithium battery 3.7 V 900 mAh, wall mount charger (cable 1.5 m), universal flexible applicator (cable 1.5 m), test emission magnet, 2 elastic bands (S and L), carrying bag, manual (GB, FR, IT, ES).



In motion magnetotherapy

## MAG 700 LOW FREQUENCY, HIGH INTENSITY MAGNETOTHERAPY



28296

### • 28296 MAG 700 MAGNETOTHERAPY - 1 channel

New portable magnetotherapy ideal for home therapy. MAG 700 offers a high level of professional performances and it's indicated for several pathologies. It allows comfortable home therapy through its basic accessories.

MAG 700 has 7 pre-set programmes for the treatment of several pathologies, 3 programmes identified by the working frequency (from 5 to 20 Hertz) and an Autoscan programme with continuous frequency variation for the treatment of both hard and soft tissues at the same time.

Possibility to adjust the magnetic field intensity for all programmes **up to 70 Gauss**. Working frequencies are between 5 and 100 Hertz. Supplied with elastic therapeutic belt with 2 solenoids, power supply, carrying bag and manual (GB, FR, IT, ES). On request DE.



28296

#### 11 PROGRAMMES

7 pre-set programmes	3 working freq.+autoscan	
Osteoarthritis	5 Hz	Autoscan
Osteoporosis	10 Hz	
Arthritis	20 Hz	
Fractures		
Articular pain		
Muscle pain		
Anti-inflammatory		

## MT BASE: MAGNETOTHERAPY

### • 28321 GIMA MT BASE PLUS - magnetotherapy

Magneto Base Plus is an ELF low frequency magnetotherapeutic unit designed for domiciliary applications.

The most important effects of the magnetic fields are: Antiedemigen, Analgesic, Antiphlogistic, Regenerative.

Applications in: traumatology, rheumatology, angiology, neurology, dermatology, endocrinology.

The magnetic field produced is impulsive.

The internal generator produces square waveform electrical current with frequency varying from 10 to 99 Hz and impulse time varying so to obtain a field's intensity determined from 10 to 80 Gauss. Internal sound sensor of magnetic field and safety system in case of short-circuit.

Two transducers can be connected at the same time (the field produced by each transducer is half of the total).

### • 28322 PLATE TRANSDUCER 70x120 mm - spare

### • 28323 VELCRO ELASTIC BAND 100x8 cm - spare

#### TECHNICAL SPECIFICATIONS

Waveform:	square
Max. ratio emission/pause:	50%
Selectable magnetic field:	from 10 to 80 Gauss
Selectable frequency:	from 10 to 99 Hz
Intensity of magnetic field:	80 Gauss (8mT)
Operating voltage:	230V/50-60 Hz
Size:	193x138xh 68 mm
Weight:	1 kg
Safety class:	II BF - Norms: EN60601-1 (CEI)



MADE IN ITALY

It is supplied with all accessories in a plastic case.

28321

#### STANDARD ACCESSORIES

Power cable	1 velcro elastic band 100xh 8 cm
2 plate transducers 80 gauss - 120x70 mm	ABS carrying case
1 velcro elastic band 60xh 8 cm	Manual (GB, IT)

## MAG 2000 LOW FREQUENCY, HIGH INTENSITY PEMF MAGNETOTHERAPY

CE 0068

Size:  
180x110x50 mm



28300

- 28300 MAG 2000 PEMF MAGNETOTHERAPY - 2 channels - 300 Gauss
- 28311 MAG 2000 PLUS PEMF MAGNETOTHERAPY - 2 channels - 400 Gauss

Ideal devices for domiciliary and professional magnetotherapy. **35 programmes: 20 pre-set programmes** for the treatment of several pathologies, **14 programmes identified by the working frequency** (from 1 to 100 Hertz) and an **Autoscan** programme with continuous frequency variation for the treatment of both hard and soft tissues at the same time.

MAG 2000 PLUS has also the possibility to store **10 user memories**, choosing the frequency up to 120 Hz, intensity and therapy time: a great possibility for the professional user who need to use a specific treatment for each patient. Possibility to set the intensity of magnetic field for all the programmes up to **300 Gauss (150 Gauss each channel)** for MAG 2000 or up to **400 Gauss (200 Gauss each channel)** for MAG 2000 Plus

to easily treat different body parts through elastic therapeutic belt with 3 solenoids.

Supplied with elastic therapeutic belt with 3 solenoids, couple of professional solenoids (28311 only), power supply, carrying bag and manual (GB, FR, IT, ES, DE).

- 28299 ELASTIC THERAPEUTIC BELT - green - spare  
Belt with cable with 3 solenoids for low frequency treatments.
- 28316 COUPLE OF PROFESSIONAL SOLENOIDS  
Couple of professional solenoids Ø 11 cm for high intensity therapy.



Couple of professional solenoids **28311**

35 PROGRAMMES (28300) - 45 PROGRAMMES (28311)		14 working freq.+autoscan	
20 pre-set programmes		14 working freq.+autoscan	
Osteoporosis	Intercostal Contusion	1 Hz	50 Hz
Arthrosis	Lumbalgy	3 Hz	60 Hz
Arthritis	Lumbar pain	5 Hz	70 Hz
Cervical arthrosis	Shoulder arthrosis	10 Hz	80 Hz
Articular pain	Knee arthrosis	15 Hz	90 Hz
Cervicalgias	Periarthritis	20 Hz	100 Hz
Sprains	Coxarthrosis	30 Hz	Autoscan
Fractures	Muscular Atrophy	40 Hz	
Epicondylitis	Muscular contracture		
Epitrocleitis	Osteonecrosis		
		<b>10 memories (28311 only)</b>	

## MAG 3000 LOW FREQUENCY, HIGH INTENSITY PEMF MAGNETOTHERAPY

CE 1936

Size:  
180x110x50 mm



28314

- 28314 MAG 3000 PEMF MAGNETOTHERAPY - 2 channels

MAG 3000 is a certified medical device for pulsed electromagnetic field magnetotherapy (PEMF). Suggested for the treatment of delayed union, osteoporosis, bone oedema, osteonecrosis, as well as ulcers and neuropathies.

Thanks to the high intensity of the magnetic field, it is also suitable for the treatment of bone fractures even in the presence of rigid bandages or plaster casts.

- two independent channels
  - colour display
  - magnetic field intensity up to 150 gauss per channel
  - frequency from 1 to 100 hz
  - 41 programmes available
  - possibility to manage two treatments at the same time by setting different times and programmes (double user)
  - list of the last 10 programmes used
- For professional users (doctors, therapist, ...) and for in-home therapy.

Operating power 110-240 V.

- 28315 ELASTIC THERAPEUTIC BELT - light blue - spare  
Belt with cable with 3 solenoids for low frequency treatments.
- 28316 COUPLE OF PROFESSIONAL SOLENOIDS  
Couple of professional solenoids Ø 11 cm for high intensity therapy.

### STANDARD ACCESSORIES

3 solenoids belt applicator	Medical power supply
User manual (GB, FR, IT, ES)*	Magnet to verify therapy operation
Carrying bag	Three non-woven fabric strips 15x150 cm
*on request DE	



**28314**

41 PROGRAMMES		
Osteoporosis	Knee arthrosis	Healing
Arthrosis	Scapulo humeral periarthritis	Cutaneous ulcers
Arthritis	Coxarthrosis	Discopathy
Cervical arthrosis	Muscular atrophy	Myalgia
Articular pain	Muscular treatment	Neuropathy
Cervicalgias	Osteonecrosis	Muscle strain
Chronic pain	Algodystrophy	Muscular cramp
Fractures	Cartilage lesion	Rizarthrosis
Epicondylitis	Ligament lesion	Impingement syndrome
Epitrocleitis	Bone cedema	Carpal Tunnel
Pseudoarthrosis	Tendinitis	Titanium prosthesis
Lumbalgy	Chondropathy	Rotator cuff
Lumbar pain	Antinflammatory	Tarsal Tunnel
Shoulder arthrosis	Whiplash syndrome	

## OSTEOMAT: MATTRESS FOR LOW FREQUENCY MAGNETOTHERAPY TREATMENTS

- 28318 OSTEOMAT MATTRESS FOR MAGNETOTHERAPY

Osteomat is composed of 4 active sectors, containing 2 solenoids each, for a total of 8 professional solenoids.

The Osteomat is the ideal solution for total body treatment in a single session, thanks to easy-to-use mode and extreme flexibility.

The configuration of Osteomat stimulates the body areas (shoulders, column, pelvis) that are more affected by bone mass reduction.

This is typical of osteoporosis pathology.

Suitable for MAG 2000, MAG 2000 PLUS, MAG 3000 and LaMagneto models.

Supplied with non-woven fabric cover (pack of 2 pieces).

Suggested for night therapy during sleep, day therapy in paralyzed patients, active patients that don't tolerate long treatments with therapeutic belt and prefer night therapy.

28318

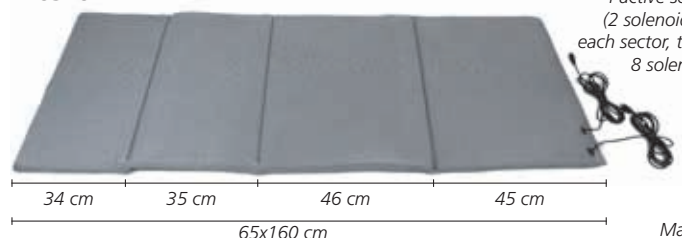

4 active sectors  
(2 solenoids for each sector, totally 8 solenoids)

Manual:  
GB, FR, IT, ES

## GIMA TENS/EMS/MASSAGE - 2 CHANNELS

• **28405 GIMA-CARE TENS - 60 medical programmes**  
Dual channel multi-functional electrotherapeutic device generates electric stimulation to help easing aches and pain, muscle training and relaxation.

Easy to use, Gima-care has 2 pre-set treatment programmes with adjustable treatment time and 1 custom programme for each body part, allowing the user to adjust treatment time and pulse rate and width.

- 3 in 1 Tens + Ems + Massage
- professional tens waveform (variable pulse frequency and width)
- body part illustration
- 60 programmes (10 body parts, 40 levels)
- powerful output (max. 120 mA) (at 500 ohm load)
- solid and clear design.

Continuous operation for around 10 treatments if fully charged.

Supplied with 4 pads 50x50 mm, 2 output cables, 1 USB cable.

User manual (GB, FR, IT, ES, DE).

• **28408 REUSABLE GELLED ELECTRODES 50x50 mm - bag of 4**



**60 PROGRAMMES**



• **28406 GIMA-THER TENS - 36 medical programmes**  
Gima-Ther is a dual channel stimulator with 3 basic functions: TENS, EMS and MASSAGE.

It has 36 programmes (18 TENS, 15 EMS and 3 Massage) and applies electric currents in the low-frequency range for therapy. It helps with blood circulation and to relieve chronic and postoperative pains. Recommended for muscle training and also for body building.

Electric impulses are transcutaneous and transmitted to nerves, muscle fibers or tissues through electrode. The intensity of the dual channel can be adjusted independently and can be applied individually to one body part.

Supplied with 4 pads 50x50 mm, 2 output cables, 4 AAA batteries and instruction manual (GB, FR, IT, ES, DE).

• **28408 REUSABLE GELLED ELECTRODES 50x50 mm - bag of 4**



**28406 36 PROGRAMMES**



60 PROGRAMMES - TENS/EMS/MASSAGE	
<b>TENS (Transcutaneous Electrical Nerve Stimulation)</b>	
Body parts:	neck, shoulder, arm, hand, back, abd, hip, leg, foot, joint
Treating programme:	30 programmes, 10 adjustable programmes
<b>EMS (Electrical Muscle Stimulation)</b>	
Body parts:	neck, shoulder, arm, hand, back, abd, hip, leg, foot
Treating programme:	27 programmes, 9 adjustable programmes
<b>MASSAGE</b>	
Methods:	knead, rub, tap
Treating programme:	3 massage manipulations to all body parts

TECHNICAL SPECIFICATIONS	
Channel:	2
Waveform:	Bi-phase square-wave pulse
Output current:	Max. 120 mA (at 500 ohm load)
Output intensity:	0 to 40 levels, adjustable
Power supply:	3.7 V Li-ion rechargeable batteries
Display:	backlight white display
Dimension - Weight:	109x54.4x23 mm - 85g
Classification:	BF type applied part, internal power equipment, IP22
Norms:	IEC60601, IEC61000-4-2, IEC61000-4-4, IEC61000-4-5, IEC61000-4-11, IEC61000-4-8, IEC61000-4-3

36 PROGRAMMES - TENS/EMS/MASSAGE	
<b>TENS (Transcutaneous Electrical Nerve Stimulation)</b>	
Body parts:	shoulder, low back, joint, hip, arms, legs
Treating programme:	18 programmes
Treating time:	30 minutes
<b>EMS (Electrical Muscle Stimulation)</b>	
Body parts:	shoulder, back, limb and hip
Treating programme:	15 programmes
Treating time:	28, 30 and 32 minutes
<b>MASSAGE</b>	
Treating programme:	3 programmes
Treating time:	30 minutes

TECHNICAL SPECIFICATIONS	
Channel:	2
Waveform:	Bi-phase square-wave pulse
Output voltage:	Max. 120 Vpp (at 1000 ohm load)
Output current:	Max. 60 mA (at 1000 ohm load)
Output intensity:	0 to 60 levels, adjustable
Output characteristics:	Constant Current (CC)
Power supply:	6.0 V D.C., 4x AAA batteries 1.5 V
Display:	Large backlit LCD
Dimension - Weight:	120.5x69.5x27 mm - 104 g
Classification:	BF type applied part, internal power equipment, IP22
Norms:	IEC60601-1, IEC60601-1-2, IEC60601-1-11, IEC60601-2-10, IEC62304

## DISPOSABLE GELLED ELECTRODES FOR ELECTROTHERAPY



**DISPOSABLE GELLED ELECTRODES WITH CABLE - latex free**  
High material flexibility allows easy application of electrodes on treated areas. Solid gel maintains the electrode adhesion and conductivity unchanged during procedure. The electrodes are equipped with 10 cm long cable, with 2 mm socket.

- **28384 GELLED ELECTRODES with cable 45x35 mm - bag of 4**
- **28351 GELLED ELECTRODES with cable 40x40 mm - bag of 4**
- **28372 GELLED ELECTRODES with cable 46x47 mm - bag of 4**
- **28373 GELLED ELECTRODES with cable 45x80 mm - bag of 4**

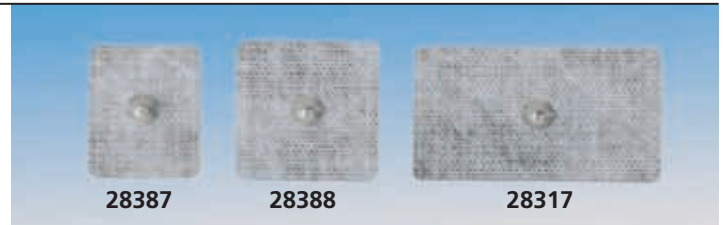

**DISPOSABLE GELLED ELECTRODES AND ADAPTORS - latex free**  
High material flexibility allows easy application of electrodes on treated areas. Solid gel maintains the electrode adhesion and conductivity unchanged during procedure.

- **28387 GELLED ELECTRODES 45x35 mm - bag of 4**
- **28388 GELLED ELECTRODES 46x47 mm - bag of 4**
- **28317 GELLED ELECTRODES 45x80 mm - bag of 4**
- **28390 2 mm CLIP ADAPTORS - black - box of 10**
- **28391 2 mm CLIP ADAPTORS - red - box of 10**
- **28392 4 mm CLIP ADAPTORS - black - box of 10**
- **28393 4 mm CLIP ADAPTORS - red - box of 10**



## MIO-CARE - 2 CHANNEL TENS

Dimensions:  
60x135x19 mm

- 28370 MIO-CARE TENS - 20 medical programmes
- 28376 MIO-CARE FITNESS - 55 programmes (20 medical + 15 beauty + 20 fitness programmes)
- 28377 MIO-CARE PRO - 63 programmes (14 medical + 15 beauty + 21 fitness + 13 free memories)

- 2 independent channels stimulator
- compensated biphasic square wave: avoids hazardous thermic effect of polarization
- easy to use, digital keyboard
- remaining therapy time and programmes instruction shown on graphic display
- internal rechargeable battery pack
- maximum intensity 100 mA (200 mA pk-pk)
- compliance with 93/42/EEC MDD

Supplied in a carrying bag with 2 connection cables with splitters, user manual\* (GB, FR, IT, DE, ES), 8 adhesive pads, internal rechargeable battery with battery charger.

\*PT on request for 28370, 28376

- 28372 GELLED ELECTRODES with cable 46x47 mm - bag of 4
- 28373 GELLED ELECTRODES with cable 45x80 mm - bag of 4
- 28383 Ni-Mh BATTERY 4.8 V for 28370/6/7, 28380/2
- 28374 BLUE AND YELLOW CABLES, 2 mm MALE PLUG - kit of 2 - spare



20 PROGRAMMES  
300 APPLICATIONS

55 PROGRAMMES  
500 APPLICATIONS

50 PROGRAMMES  
13 FREE MEMORIES

14 MEDICAL PROGRAMMES (all)	15 BEAUTY PROGRAMMES (28376, 28377)	20 FITNESS PROGRAMMES (28376, 28377)
Tens conventional (rapid) Tens endorphinic (delayed) Tens maximum values Inflammatory Neck pain/cervicogenic headache Backache/sciatic pain Sprains/bruises	Vascularization Muscle relaxant Hand and wrist pain Plantar stimulation Epicondylitis Epitroclea Periarthritis	Firming up - upper limbs and trunk Firming up - lower limbs Toning up - upper limbs and trunk Toning up - lower limbs Definition - upper limbs and trunk Definition - lower limbs Modelling Microlifting Lipolysis - abdomen
+6 MEDICAL PROGRAMMES (28370, 28376)		
Haematomas Atrophy prevention Atrophy (trophism rehabilitation)	Microcurrent Stress incontinence Urgency incontinence	Warming up Resistance-upper limbs and trunk Resistance-lower limbs Resistant strength - upper limbs and trunk Resistant strength - lower limbs Basic strength - upper limbs and trunk Basic strength - lower limbs Fast strength - upper limbs and trunk Fast strength - lower limbs Explosive strength - upper limbs and trunk Explosive strength - lower limbs <b>+1 FITNESS PROGRAMME (28377 only)</b>
		Deep capillarization Muscle recovery Agonist - antagonist Sequent. tonic contract. - upper limbs and trunk Sequential tonic contractions - lower limbs Sequential phasic contract. - upper limbs and trunk Sequential phasic contractions - lower limbs Muscle relaxant Deep massage
		EMS

## I-TECH PHYSIO PROFESSIONAL 2 CHANNELS STIMULATOR

- 28382 I-TECH PHYSIO PROFESSIONAL STIMULATOR Professional stimulator with 2 independent channels
- compensated biphasic square wave: current quantity from positive pole to negative one is constant to avoid hazardous thermal effect of polarization
- monophasic square wave
- incontinence and ionophoresis programmes
- denervated treatment
- programmable TENS - EMS memories
- adjustable frequency, width impulse, time, ramp
- remaining therapy time and programmes instructions shown on the LCD
- maximum intensity 200 mApp;

Can use same gelled electrodes with cable as Mio-Care

- 28381 IONOPHORESIS KIT - spare (1 elastic band, 2 silicone conductive electrodes, 2 sponges)
- 28383 Ni-Mh BATTERY 4.8 V for 28370/6/7, 28380/2
- 28374 BLUE AND YELLOW CABLES, 2 mm MALE PLUG - kit of 2 - spare

Supplied in a carrying bag with:

- rechargeable battery and battery charger
- 1 set of 4 pregelled electrodes 48x48 mm
- 1 set of 4 pregelled electrodes 50x90 mm
- 2 silicon conductive electrodes 60x90 mm
- 2 sponges 70x100 mm
- 1 elastic belt for electrodes fastening
- 2 cables, 2 mm connection male plug
- 4 cable splitter 2 mm male and female plug

User manual: GB, FR, IT, ES, on request PT, DE.

Backlit display



Digital easy to use keyboard

PROGRAMMES:  
21 NEMS  
15 BEAUTY  
27 REHABILITATION  
14 TENS  
9 UROLOGY  
13 FREE MEMORIES

## MIO IONOTENS, 2 CHANNELS

- 28380 MIO-IONOTENS 37 programmes
- 2 channel stimulator with high output power and a complete list of TENS programmes, rehabilitation programmes and free memories. Portable and easy to use with backlit display and digital keyboard. 14 TENS programmes, 10 rehabilitation programmes including 3 ionophoresis treatments and 13 free memories (adjustable frequency, width impulse and time). Supplied in a carrying bag, with 2 cables, ionophoresis kit, 1 set of 4 pre-gelled electrodes (41x41 mm), 1 set of 4 pre-gelled electrodes (40x80 mm), belt clip, internal rechargeable battery (long lasting), charger, user manual GB, FR, IT, ES (DE on request).
- 28381 IONOPHORESIS KIT - spare (1 elastic band, 2 silicone conductive electrodes, 2 sponges)
  - 28383 Ni-Mh BATTERY 4.8 V for 28370/6/7, 28380/2
  - 28374 BLUE AND YELLOW CABLES, 2 mm MALE PLUG - kit of 2 - spare



28380

## LATEX-FREE RESISTIVE EXERCISE BANDS

Latex-free bands available in 7 colour-coded levels of resistance and 3 lengths (1.5, 5.5 and 45 m). These reliable and effective bands are ideal to improve strength, range of motion.

Use of these bands for resistive exercise provides force on the muscles. Excellent for upper and lower body therapy.

Latex-Free Exercise Bands provide the same benefits as regular bands.



Latex-free exercise bands - 1.5 m

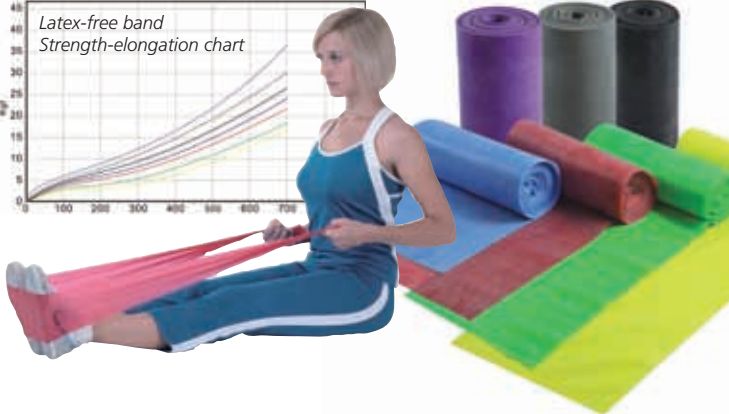
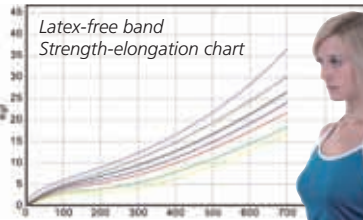

GIMA Code	LATEX FREE EXERCISE BANDS - 1.5 m	
47000	Latex-free band 1.5 m x 14 cm x 0.20 mm	●
47001	Latex-free band 1.5 m x 14 cm x 0.25 mm	●
47002	Latex-free band 1.5 m x 14 cm x 0.30 mm	●
47003	Latex-free band 1.5 m x 14 cm x 0.35 mm	●
47004	Latex-free band 1.5 m x 14 cm x 0.40 mm	●
47007	Set of 5 latex-free bands (1x5 levels) 1.5 m x 14 cm mix	
LATEX FREE BANDS - 5.5 m		
47010	Latex-free band 5.5 m x 14 cm x 0.20 mm	●
47011	Latex-free band 5.5 m x 14 cm x 0.25 mm	●
47012	Latex-free band 5.5 m x 14 cm x 0.30 mm	●
47013	Latex-free band 5.5 m x 14 cm x 0.35 mm	●
47014	Latex-free band 5.5 m x 14 cm x 0.40 mm	●
47015	Latex-free band 5.5 m x 14 cm x 0.50 mm	●
47016	Latex-free band 5.5 m x 14 cm x 0.60 mm	●
LATEX FREE BANDS - 45 m		
47020	Latex-free band 45 m x 14 cm x 0.20 mm	●
47021	Latex-free band 45 m x 14 cm x 0.25 mm	●
47022	Latex-free band 45 m x 14 cm x 0.30 mm	●
47023	Latex-free band 45 m x 14 cm x 0.35 mm	●
47024	Latex-free band 45 m x 14 cm x 0.40 mm	●



## LATEX TONE LOOPS

### • 47040 SET OF 4 TONE LOOPS

The closed-loop flat band fits comfortable around the upper and lower legs. It helps to exercise the muscles of hips and legs.

Set includes 4 below loops: each in a different colour-coded level.  
 Tone loop 18 mm x 58 cm x 1.4 mm  
 Tone loop 24 mm x 58 cm x 1.4 mm  
 Tone loop 24 mm x 58 cm x 1.6 mm  
 Tone loop 30 mm x 58 cm x 1.6 mm

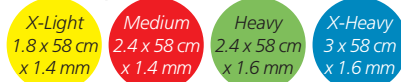

47040

## EXERCISE MATS

### • 47070 EXERCISE MAT 180x60xh 1.6 cm - light blue

### • 47080 EXERCISE MAT WITH HANG RING - 180x60xh 1.6 cm - green

Thick mats with sponge-like foam structure offer comfortable feeling. The closed-cell foam structure resists moisture. Easy roll for storage.

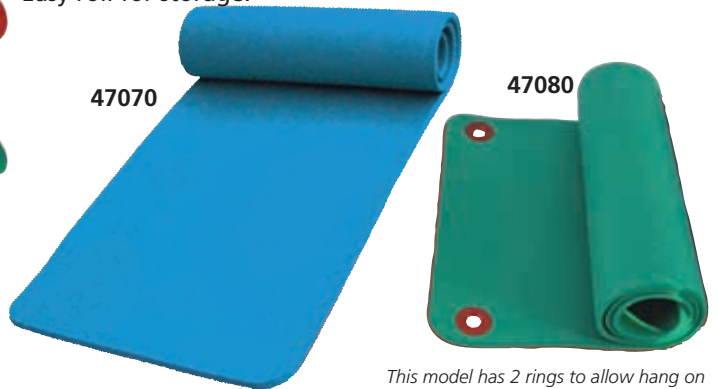

This model has 2 rings to allow hang on the wall or on the rack

## RESISTIVE EXERCISE TUBING

Tubing is an affordable and convenient training tool which provides effective upper and lower-body workout. Elastic properties for resistive and strengthening exercise.

### Latex exercise tubing



GIMA Code	LATEX EXERCISE TUBING	Thickness	Strength	Length
47060	Latex tube	1.5 mm	●	25 m
47061	Latex tube	2 mm	●	25 m
47062	Latex tube	2.5 mm	●	25 m
47063	Latex tube	3 mm	●	25 m
47064	Latex tube	3.5 mm	●	25 m

Available also with two pre-attached durable foam covered handles for comfort and grip.

5 colour-coded resistance levels available.

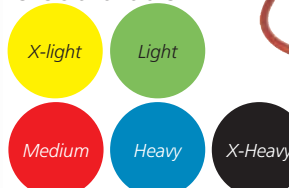

GIMA Code	LATEX TUBE WITH TPR HANDLES	Strength	Length
47050	Latex tube with TPR handles	●	125 cm
47051	Latex tube with TPR handles	●	125 cm
47052	Latex tube with TPR handles	●	125 cm
47053	Latex tube with TPR handles	●	125 cm
47054	Latex tube with TPR handles	●	125 cm



## HAND/FINGER/WRIST EXERCISERS

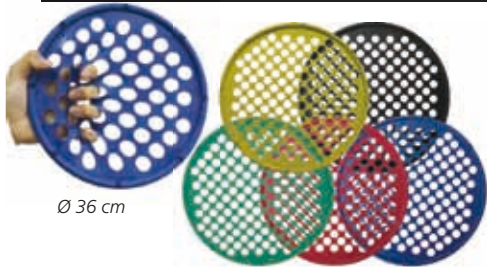

Ø 36 cm

- 47130 GRIP TRAINER - X-light
  - 47131 GRIP TRAINER - light
  - 47132 GRIP TRAINER - medium
  - 47133 GRIP TRAINER - heavy
  - 47134 GRIP TRAINER - X-heavy
- Releases typing and mousing tension. Improves hand and finger flexibility. Excellent for finger and wrist strengthening and rehabilitation.

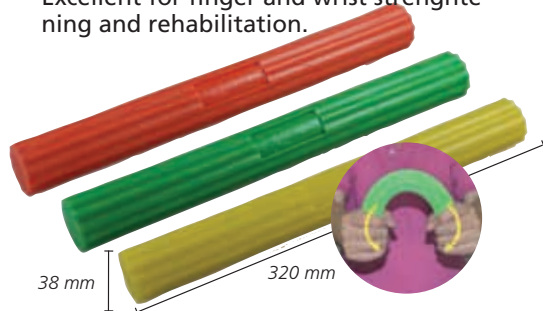

38 mm 320 mm

- 47170 TPR FLEX BAR - light
  - 47171 TPR FLEX BAR - medium
  - 47172 TPR FLEX BAR - heavy
- Flex bar is a flexible, durable resistance device with ridge surface for enhanced grip during use. It is used to improve grip strength by bending, twisting or vibrating.



- 47160 SET OF 3 FINGER EXERCISERS
- Unique design for rehabilitation, excellent stress-reliever for users. Simply insert fingers into circles and stretch. Multiple resistance level available, set of light, medium and heavy resistance.



- 47180 POWER GRIP - light
  - 47181 POWER GRIP - medium
  - 47182 POWER GRIP - heavy
- Develop finger flexibility, strength and coordination. Increase hand, wrist and forearm strength. Improve the injured finger recovery.



- 47140 SQUEEZE EGG - X-soft
  - 47141 SQUEEZE EGG - soft
  - 47142 SQUEEZE EGG - medium
  - 47143 SQUEEZE EGG - firm
  - 47144 SQUEEZE EGG - X-firm
- These TPE (Thermoplastic elastomers) eggs offer variable resistance training for hands and fingers. Help grip strengthening and reduce stress.

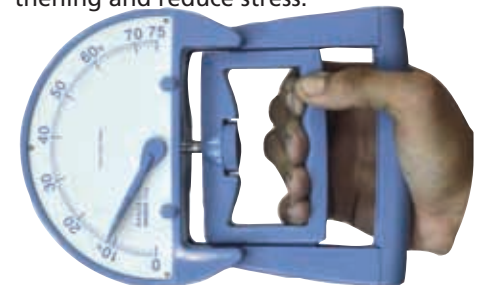

- 28790 HAND GRIP METER - plastic
- Indicator remains at maximum until reset and is calibrated 0-75 kg. Size 20x15 cm. Sold in a blister. Manual in: GB, FR, IT, ES.

## BALANCE AND WEDGE CUSHION



Balance. Wellness. Training

Balance

Sit ups

Oblique stretch

Squats

Side squats  
Inflation hole with valve

The saw

Push ups

Standing saw

Pelvic lift

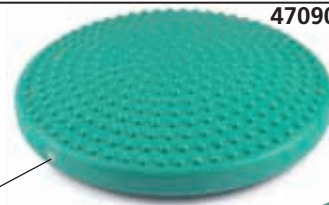

47090



47095

- 47090 BALANCE CUSHION Ø 35 cm
  - 47095 WEDGE CUSHION
- Air filled cushions made of soft, pliable material. Both have two surfaces: smooth and bubbled which provide two kinds of user experience. Great for improving intramuscular coordination as well as balance training ergonomic sitting and rehabilitation. Maximum load: 136 kg (300 lb)

## RESISTANT BALLS

- 47102 BURST RESISTANT BALL - Ø 55 cm
  - 47103 BURST RESISTANT BALL - Ø 65 cm
  - 47104 BURST RESISTANT BALL - Ø 75 cm
- Designed for dynamic workouts that incorporate moderate level of resistance. Deflate slowly if punctured. 136 kg (300 lb) burst resistance level.

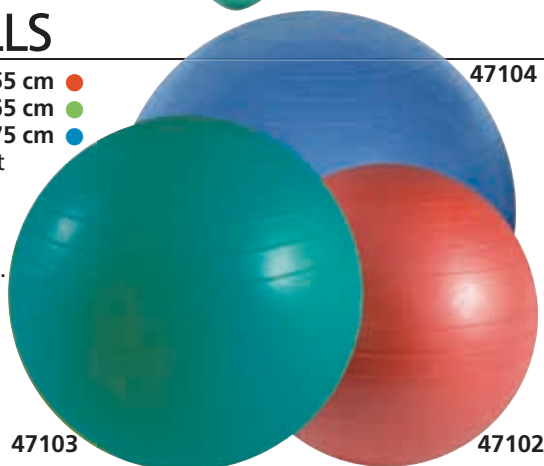

47104

136 kg burst resistance level

47103

47102

## MASSAGE BALLS

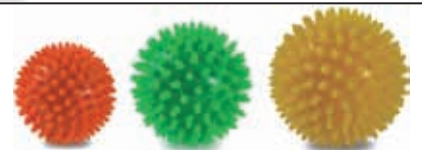

- 47120 MASSAGE BALLS
- Set of 3 massage balls Ø 6, 7, 8 cm



## NASAL WASH



28084

• **28084 SINUS A NASAL WASH - for adult - bottle 120 ml + 12 saline sachets**  
Nasal wash helps to remove the sinus symptoms such as runny nose, nasal dryness and nasal congestion. By performing a nasal wash, you can remove particles such as pollen and dust in order to reduce the mucous membranes inflammation and make it more resistant to allergies.

## HUMI-RAINBOW

Mist output can be adjusted in direction (360° rotative head) and speed (adjustable knob)



28070

• **28070 HUMI-RAINBOW HUMIDIFIER**  
A cold-mist ultrasonic humidifier with an attractive design and cromatic 7-led colours change  
• **28071 BALSAMIC ESSENCE - pine**  
• **28072 BALSAMIC ESSENCE - citrus**



### TECHNICAL SPECIFICATIONS

Power feeding: AC 110-240V / 50-60 Hz  
Max mist output: 280 ml/h  
Water Tank capacity: 2.8 l  
Suitable for room size: min 10, max 25 m<sup>2</sup>  
Max operating hours (non-stop): 10 hours  
Size (individual box): Ø 19xh 30 cm - Weight: 1.4 kg

## VAPINAL INHALER



Bottle not included

Carrying handle

Steam nebulizer with adjustable position

CE 0123

MADE IN ITALY

• **28110 VAPINAL THERMAL WATER INHALER**  
Warm jet mineral water inhaler ideal for home spring water inhalation treatment. It delivers hot humid steam through a nozzle working with the Venturi system and mixing the steam with the principles of thermal water. Stainless steel boiler. Supplied with polycarbonate ampulla.  
• **28112 VAPINAL AMPULLA - spare part**

### TECHNICAL SPECIFICATIONS

Capacity: 800 ml  
Steam boiler in stainless steel  
Security valve and thermostat  
Operating voltage: 230 V - 50 Hz - 600 Watt  
Heating time: 5-8 min  
Inhalation time (for 1 l): 12-15 min

## MAMILAT BREAST PUMP

• **28148 MAMILAT - BREAST PUMP - 230 V - 50 Hz**  
Easily transportable from one maternity ward to another, or for use at home. Made of highly heat-resistant, electrically insulated plastic material in conformity with the latest European safety standards. Working time: 20 minutes ON, 40 OFF. Suction adjustment knob. Supplied with 2 polycarbonate milk bottles (150 cc and 250 cc) antibacterial and hydrofobic filter, set of tubes 6x10 mm, breast shield, PVC air tube.  
• **28229 HYDROPHOBIC ANTIBACTERIAL FILTER - spare**  
• **28149 SPARE KIT**  
Includes two plastic bottles (125 cc and 250 cc) nipple shield, filter and tubes.



CE

Supplied with anti-bacterial filter

MADE IN ITALY

5 languages manual: IT, GB, ES, FR, DE.

28149

28148

### TECHNICAL SPECIFICATIONS

Regulator for suction intensity: max suction -0.33 bar (-248 mmHg)  
Operating voltage: 220-230 V - 50/60 Hz - available on request 110 V - 60 Hz  
Max flow (air litres/min): 14 l/min  
Power consumption: 184 VA  
Size: 235x190x165 mm  
Noise level: 63 dB  
Weight: 2.2 kg  
Norms: CEI 62-5 (IEC601-1). IP Protection Class: IP21

## BREAST PUMPS

• **41700 MANUAL BREAST PUMP**  
• **41701 SINGLE ELECTRIC BREAST PUMP**  
Compact and lightweight breast pumps for efficient and discreet pumping. Easy to assemble, use and clean. Supplied with breast shield, nipple with cover, milk bottle with lid, multilingual box and manual (GB, FR, IT, ES, PT, DE).



CE 0197

All parts that touch breast milk are made without BPA, phthalate free

2 phase design, easy for stimulation and expression

Soft and comfortable breast shield

Graduated bottle (ml/Oz)

10 vacuum levels

41701

• **41706 BREAST MILK BOTTLE 150 ml with lid - set of 3 - spare**  
• **41705 BREAST SHIELD + NIPPLE - spare**  
• **41708 AC ADAPTER for 41701 - optional**

### TECHNICAL SPECIFICATIONS

	41700	41701
Vacuum mmHg:	- 250	stimulate: - 60-130 expression: - 60-250
Weight:	159 g	265 g
Size mm:	205x186x90	129x129x55
Operation:	manual	4AA batteries not included or AC adapter (optional)



CE

41700

Comfortable handle

## MESH NEBULIZER

### • 28066 MESH NEBULIZER

Small, handy, lightweight nebulizer for the treatment of respiratory diseases such as acute inflammation, tracheitis, bronchitis, swelling and pain in throat. It can operate with 2xAA standard batteries or USB cable.

- maximize the benefits of medicine
  - portable, handheld design (117 mm height)
  - ultra-low noise, ultra-light only 104g
  - one-button operation for easy use
  - for adult and child: noiseless use and compact design allow to make inhalation even while children are sleeping.
- Supplied with adult and child mask, mouthpiece, 2xAA batteries, USB cable, carrying bag, multilingual manual and box (GB, IT, FR, ES, PT, DE).

- 28067 RESPIRATORY ACCESSORY KIT (adult and child mask, mouthpiece) - spare
- 28068 NEBULIZER HEAD - spare



28068

#### TECHNICAL SPECIFICATIONS

Power supply:	2xAA batteries or USB cable DC 5V
Ultrasonic frequency:	approximately 110kHz
Nebulizer rate:	≥0.25ml / min
Max. / min. liquid volume:	10ml / 0.5ml
MMAD	approximately 4µm
Nebulizing head life:	180 hours
Battery life:	60 minutes
Shutdown:	automatic without liquid
Safety level:	Type BF, Class II, IP 22



## MYNEB NEBULIZER

### • 28073 MYNEB NEBULIZER - piston

Compact, fast and silent nebulizer. Suitable for the treatment of the respiratory tract diseases, bronchial and asthmatic diseases, allergies.

Ideal for nebulizing any medicine, even oily ones such as cortisones essentials oils, and active ingredients with solid elements (suspensions). Supplied with carrying bag, fasterjet bulb, adult and pediatric mask, air tube, mouthpiece and nosepiece.

Multilingual box and manual: GB, FR, IT, ES, DE. Class IIa.

- 28093 FILTER - spare - box of 3



CE 0051

28073

MADE IN ITALY

COMPACT AND SILENT

#### TECHNICAL SPECIFICATIONS

AC adapter:	input 100-240 V - 50/60 Hz - 0,6 A output 12 V - DC 2A
Operating cycle:	30/30 min. ON/OFF
Noise level:	51 dB
Nebulization rate:	0.45 ml/min with NaCl 0.9%
Air Flow:	12 l/min
Max pressure:	165 kPa/1.65 bar
Particle size:	75% < 5 µm (NaCl 0.9%)
Size and weight:	132x140x60 mm - 450 g

## ACCESSORIES FOR ANY BRAND OF NEBULIZER

### ACCESSORIES FOR NEBULIZER

Gima offers different nebulizer bulbs with their line of accessories, suitable for any brand of nebulizer.

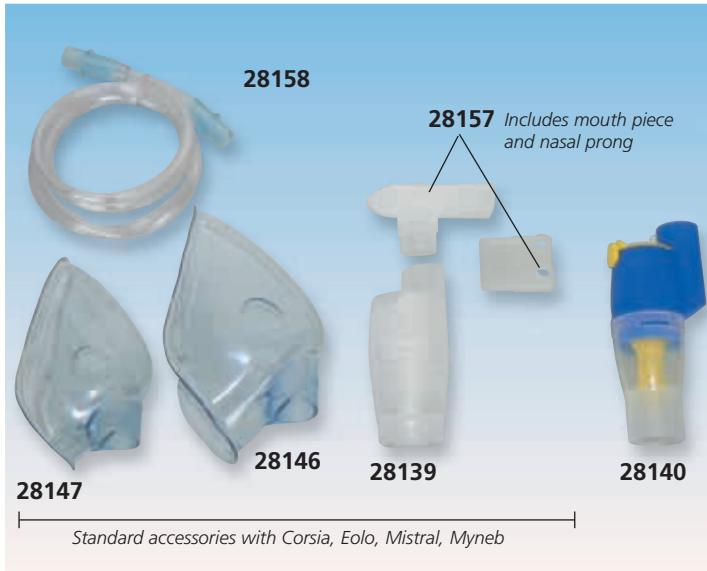

28158

28157 Includes mouth piece and nasal prong

28146

28139

28140

28147

Standard accessories with Corsia, Eolo, Mistral, Myneb

### FASTERJET BULB with Valve System

A new designed Jet Nebulizer capable of delivering any medication in a very short time with a high amount of respirable particles.

The Valve System makes therapy extremely efficient by reducing the amount of wasted medication while optimizing the output to the patient.

#### TECHNICAL SPECIFICATIONS FASTERJET

Capacity:	16 ml	Neb rate:	0.60 ml/min
Respirable volume:	<5 µm 80%		
Residual volume:	0.8 ml		
MMAD (Mass Median Aerodynamic Diameter):	2.7 µm		

Fasterjet bulb: For delivering any medication in a very short time

28163 + 28165



28164

28166

28168

28169

28145

GIMA code	NEBULIZER ACCESSORIES	Compatible with
	Standard accessories with Myneb, Corsia, Eolo, Mistral	
28158	PVC connection tube - 1m	all nebulizers
28139	Nebulizer bulb	all nebulizers
28146	Facemask - adult* - replaces 28143	bulb 28139/28140
28147	Facemask - paediatry* - replaces 28144	bulb 28139/28140
28157	Mouthpiece - nasal prong	bulb 28139/28140
28138	Nebulizer kit	all nebulizers
	adult and pediatric facemask, pvc-tube, bulb, nasal prong, mouthpiece	
28140	Nebulizer bulb	all nebulizers

GIMA code	NEBULIZER ACCESSORIES	Compatible with
28163	Fasterjet bulb* with Valve System	all nebulizers
28164	Nebjet bulb** with Double Venturi Effect	all nebulizers
28165	Mouthpiece bi-valve	bulb 28163
28166	Mouthpiece	bulb 28164,
28167	Nasal Prong	bulb 28164, 28163
28168	Facemask-adult***	bulb 28164, 28163
28169	Facemask-pediatry***	bulb 28164, 28163
28145	Filter - spare	28130/1/2/3/4/5

\*Standard with Happyneb II, Hospyneb  
\*\*Without elastic

\*\*\*Standard with Happyneb I, III, Betaneb

## HAPPYNEB NEBULIZERS FOR DOMESTIC USE - PISTON

• 28132 HAPPYNEB II NEBULIZER - piston 230V- Faster-Jet

• 28135 HAPPYNEB III NEBULIZER - piston 230V

Happyneb stylish and portable piston nebulizer for a quick and efficacious aerosol therapy.

**Reliable, practical and safe.**

Noiseless and lubrication free.

Unit includes an air filter to be replaced every 70 applications, and handle for easy carrying.

It is built in accordance with European Standard EN 60601-1.

**5 languages box and manuals:**

**GB, FR, IT, ES, DE**

• 28145 FILTER - spare

MADE IN ITALY

Faster-jet bulb  
Nebulizing time: 1 cc  
about 3 minutes



28132



Nebjet bulb

28135



### NEBULIZER TECHNICAL DATA

	Happyneb III with Nebjet	Happyneb II with Fasterjet
Capacity:	12 ml	16 ml
Respirable volume < 5 µm	75%	80%
MMAD (Mass Media Aerodynamic Diameter)	2.32 µm	2.7 µm
Neb rate	0.45 ml/min	0.60 ml/min
Residual volume	0.7 ml	0.7 ml

### STANDARD ACCESSORIES

Adult and pediatric face mask	Mouthpiece
Nasal prong	Fasterjet bulb (28132 only)
Connection tubing	Nebjet bulb (28135 only)

### TECHNICAL SPECIFICATIONS

	28132 - HAPPYNEB II	28135 - HAPPYNEB III
Voltage:	230V/50 Hz	
Maximum pressure:	280 kPa	250 kPa
Operating pressure:	110 kPa	90 kPa
Air flow:	15 l/min	14 l/min
Dimensions:	31x22x13 cm	
Weight:	2.3 kg	2 kg
Noise level	58 db	58 db
Temporary use:	Continuous use	30/30 min ON/OFF
Class of risk - norms	IIa - Class II, Type B	

## ATOMIZER 2 SPEEDS, PISTON NEBULIZER FOR FAMILY USE

• 28094 ATOMIZER NEBULIZER - 2 speeds

Piston-type compressor with 2 speeds for family use. With accessory compartment separated from cord compartment for improved hygiene.

• 28093 FILTER - spare - box of 3

### TECHNICAL SPECIFICATIONS

Operating voltage:	230 V - 50 Hz
Operating cycle:	continuous
Operating pressure:	speed 1: 45 kPa - speed 2: 60 kPa
Air Flow:	speed 1: 8 l/min - speed 2: 11 l/min
Nebulization rate:	speed 1: 0.2 ml/min - speed 2: 0.35 ml/min
Particle size:	80% < 5 µm
Max pressure:	1.85 bar / 185 kPa
Weight:	1.4 kg
Noise level:	56 db
	Class of risk: IIa



Standard accessories

MADE IN ITALY

### STANDARD ACCESSORIES

Nebjet bulb with connector  
Adult and child mask  
Mouth piece and nose piece  
Air tube and 3 air filter



28094



Accessories compartment

## EOLO NEBULIZER - PISTON



• 28097 EOLO NEBULIZER - piston

• 28091 EOLO NEBULIZER - piston - UK plug

Innovative, portable, easy to use nebulizer for home use, recommended to nebulize antibiotics and bronchodilator drugs. Plastic body with high thermal insulation. Supplied with adult and pediatric face mask, bulb, mouthpiece, air tubing, air filter.

Multilingual user manual and box (GB, FR, IT, DE, ES, PT, GR, PL\*, Arabic\*).  
Warranty 2 years.

• 28095 FILTER - box of 20 pcs.

MADE IN ITALY

### TECHNICAL SPECIFICATIONS

	28097 EOLO	28102 MISTRAL
Operating voltage:	230V - 50/60Hz - 170VA	230V - 50/60 Hz - 170VA
	110V or 60Hz on request	
Operating pressure:	1.1 bar	1.1 bar
Air flow:	14 l/min	14 l/min
Nebulization rate	0.4 ml/min	0.35 ml/min
Particle size	< 5 µm	< 5 µm
Max Pressure:	2.5 bar	2.5 bar
Dimensions:	22x14.5x12 cm - 1.7 kg	13x8.9x14.6 cm - 1.5 kg
Noise level (EN 13544-1)	55 db	60 db
Class of risk	IIa	IIa
Norms:	insulation class, Type B	insulation class, Type BF

28097



\*Box only, not manual

## MISTRAL NEBULIZER - PISTON

• 28102 MISTRAL NEBULIZER - piston

Compact portable nebulizer for home use.

Duty cycle: 20 min on / 40 min off.

Supplied with Hi Flo bulb, adult and pediatric mask with string, mouthpiece, nosepiece, air tubing and air filter.

Multilingual user manual and box: GB, FR, IT, ES, PT, DE.

• 28088 FILTER - box of 20

• 28103 CARRYING BAG - optional



28102

# NEBULIZERS FOR PROFESSIONAL AND HOSPITAL USE



**28089**  
Nasaljet is a quick effective nasal irrigation device for rinsing the nasal and rhino-pharyngeal cavities



**28090**

MADE IN ITALY

CONTINUOUS USE COMPRESSOR

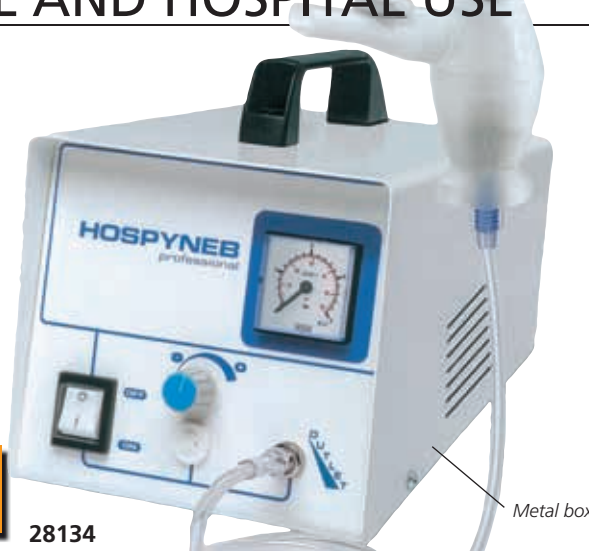

**28134**

Metal box

## PROFESSIONAL NEBULIZERS

Piston compressor nebulizers for professional and home care use. They embody all the dictates of modern aerosol therapy techniques. Reliable and simple to use, also by inexperienced users. Manual: GB, FR, IT, DE, ES.

GIMA code	PROFESSIONAL NEBULIZER
28134	Hospyneb professional
28090	Comp-a neb professional
28089	Nasaljet
28176	Compressor - spare for 28134
28152	Connecting rod and crank group 3AC260 - spare for 28134
28153	Cylinder 3A1062 - spare for 24134, 28090
28145	Filter - spare

## TECHNICAL SPECIFICATIONS

	HOSPYNEB	COMP-A NEB
Operating voltage:	230 V - 50/60 Hz	230 V - 50 Hz
Size:	28x19xh 17 cm	19.6x35.7xh 18.5 cm
Max pressure:	350 kPa (3.5 bar)	250 kPa
Noise level:	60 dBA	55 dBA
Operating pressure:	0-130 kPa (0-1.3 bar)	0-110 kPa
Weight:	4.1 kg	2.5 kg
Air Flow:	15 l/min	
MDD class:	IIa	

## STANDARD ACCESSORIES

Fasterjet nebulizer with valve system  
Nosepiece irrigation (polypropylene)  
Mouthpiece (polypropylene) with valve (silicone)  
Adult and child mask (PVC DEHP free)  
Air tube (PVC DEHP free) and spare filter.  
Nasaljet (only with 28090).



- 28105 CORSIA PROFESSIONAL NEBULIZER - piston
- 28092 CORSIA PROFESSIONAL NEBULIZER - piston - without manometer

Piston-type compressor nebulizers designed for continuous use. High performance with any type of drug, ideal for intensive hospital and clinic use. Recommended for atomizing antibiotics and bronchodilator drugs. Manufactured with high thermal



**28105**



CONTINUOUS USE COMPRESSOR

MADE IN ITALY

and electric insulation plastic chassis in accordance with the latest European Safety regulations. The oil-free piston compressor has long durability and is equipped with the highly efficient HI-FLO jet nebulizer to guarantee quick and accurate drug delivery. Easy to handle and transport.

- 28104 FILTER - spare - box of 2
- 28217 2 PIN British plug - optional

## TECHNICAL SPECIFICATIONS

Operating Voltage:	220-230 V - 50/60 Hz
Power consumption:	184 VA
Max pressure:	250 kPa (2.5 bar)
Air flow:	16 l/min
Operating pressure:	130 kPa (1.30 bar)
Operating air flow:	5.2 l/min at 130 kPa
Nebulization rate:	0.50 ml/min with 4 ml solution
MMAD:	3.25 µm GSD: 3.45
Size:	255x190xh 105 mm
Noise level:	Weight: 2.2 kg approx 57 db

**28092**



## STANDARD ACCESSORIES

HI-FLO Jet bulb Mouthpiece Nose piece  
Adult and child mask Air tube and air filter  
Multilingual user manual and box: GB, FR, IT, ES, DE, PT, RO, RU\*, PL\*, GR\*

\*Box only

# NEBULIZER FOR INTENSIVE HOSPITAL USE

• 28060 CLINEB PRO NEBULIZER - piston  
High performing piston nebulizer for administration of any kind of drug, ideal for intensive hospital and clinical use. Its structure is made of a high thermal and electrical insulated plastic in accordance to safety European standards. Long life dry piston compressor and bulb with a valve system that allows to adjust the nebulization speed.

Class IIa - Insulation class (EN60601-1): Class II Type B.

- 28062 BULB - spare
- 28063 FACE MASK - adult - spare
- 28064 FACE MASK - pediatric - spare
- 28217 2 PIN British plug - optional

## TECHNICAL SPECIFICATIONS

Operating Voltage:	230 V - 50/60 Hz	Power consumption:	110 VA
Max pressure:	250 kPa (2.5 bar)	Air flow:	16 l/min
Operating pressure:	130 kPa (1.30 bar)	Operating air flow:	5.2 l/min at 130 kPa



**28060**

MADE IN ITALY

## STANDARD ACCESSORIES

Bulb with valve  
Mouthpiece  
Adult and child mask  
Air tube and air filter  
Multilingual manual: GB, FR, IT, ES, DE

# VEGA SUCTION UNITS, HIGH VACUUM, LOW AND HIGH FLOW



**HIGH VACUUM  
HIGH FLOW**

MADE IN ITALY



28211

28210

## VEGA SUCTION UNITS

A line of stylish, compact and reliable aspirators for small surgery. Silent, high flow and maintenance - free pumps allow long product life and durability. Recommended for nasal aspiration, oral aspiration, tracheal aspiration of body liquids (mucus, catarrh or blood) in adults or children. Equipped with vacuum regulator continuously adjustable, vacuum indicator, unbreakable 1,000 ml or 2,000 ml Makrolon® jar, autoclavable at 121°C with safety float control valve to prevent overflow. Optional APEC® jar autoclavable at 143°C. Manufactured in electric and thermal insulated plastic body.

**Flovac® autoclavable jars and disposable collection system:** in addition to standard autoclavable jar, a disposable collection system is available, composed by a rigid reusable jar, a polyethylene disposable liner with hermetically sealed cover and hydrophobic, antireflux, antibacterial filter operating as an overflow valve.

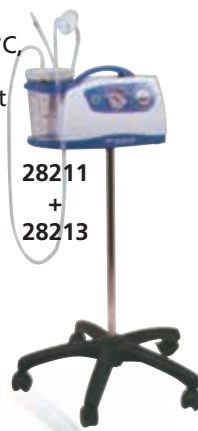

28211 + 28213



1 l polycarbonate autoclavable jar with overflow safety valve

28209

28252 Adaptor to connect catheter to silicone tube

### STANDARD ACCESSORIES

- Autoclavable jar (1 or 2 l) with overflow valve system
- Antibacterial and hydrophobic filter
- Set of silicone tubes 6x10 mm
- Conical connector for probes
- 6 languages user manual (GB, FR, IT, DE, ES, PT)

28229



### TECHNICAL SPECIFICATIONS

	28209 VEGA UNO	28210 VEGA	28205, 28211 SUPERVEGA
Operating Voltage:	220-230 V - 50/60 Hz 120-127 V - 60 Hz (on request)	220-230 V - 50/60 Hz 110 V - 60 Hz (on request)	220-230 V - 50/60 Hz or 110-127 V - 60 Hz
Power consumption:	184 VA	184 VA	110 VA
Bottle capacity:	1,000 ml	1,000 ml	1,000 ml or 2,000 ml
Flow (air litres/min):	15 l/min	16 l/min	40 l/min
Max suction:	-0.75 bar (563 mm/Hg)	-0.75 bar (563mm/Hg)	-0.80 bar (600mm/Hg)
Operating cycle:	continuous	continuous	continuous
Noise level:	59.6 dBA	60.5 dBA	60.5 dBA
Size - weight:	25x19x16.5 cm - 2.2 kg	35x21x18 cm - 2.5 kg	35x21x18 cm - 3.6 kg
Norms:	EN 60601-1-1, EN 60601-1-2, EN 60601-1-11, 93/42/EEC		

GIMA code	VEGA SUCTION ASPIRATOR	Operating power	Flow
28209	Vega Uno	220-230 V - 50/60 Hz	15 l/m
28210	Vega	220-230 V - 50/60 Hz	16 l/m
28211	Super Vega 1l	220-230 V - 50/60 Hz	40 l/m
28205	Super Vega 1l with footswitch*	220-230 V - 50/60 Hz	40 l/m
28212	Super Vega 2l	220-230 V - 50/60 Hz	40 l/m
28189	Super Vega 1l	110-127 V - 60 Hz	40 l/m

\*With proximity: no touch ON/OFF function



GIMA code	SPARE ACCESSORIES FOR VEGA AND TOBI LINE
28229	Hydrophobic, antibacterial filter
28226	121°C autoclavable jar 1 l with cover and overflow system
28236	121°C autoclavable jar 2 l with cover and overflow system
28227	Cover and overflow valve system for 28226 and 28236
28185	143°C autoclavable jar 1 l with cover and overflow system
28186	143°C autoclavable jar 2 l with cover and overflow system
28184	Cover and overflow valve system for 28185 and 28186
28271	Flovac® disposable liner 1 l (cover + bag)
28268	Flovac® disposable liner 1 l (cover + bag) - box of 50
28270	Flovac® disposable jar for disposable liner 1 l
28273	Flovac® disposable liner 2 l (cover + bag)
28269	Flovac® disposable liner 2 l (cover + bag) - box of 50
28272	Flovac® jar for disposable liner 2 l Ø 13 cm top, 9.5 cm bottom
25468	Silicone tube 6x10 mm - roll of 30 m
28252	Adaptor to connect catheter to silicone tube
	Suction catheter - see at page 51
28213	Trolley for Vega and Super Vega (not for Vega Uno)
28276	Vacuum indicator for Vega and Super Vega (not for Vega Uno)
28217	2 pin British plug - optional

# PROFESSIONAL ASPIRATORS - HIGH VACUUM



28280-1

CE 0051  
EN ISO 10079-1  
Class I  
Type B



Anti-bacterial filter

Double pump type

Vacuum gauge

MADE IN ITALY

Overflow regulation knob

28244-6

1 l Autoclavable Jar

## ASPEED PROFESSIONAL SURGICAL ASPIRATORS

Piston-type continuous cycle electric aspirators give high performance and great durability. Equipped with a protective thermal cut-out relay. They require no maintenance or lubrication. A motor-protector cap totally prevents aspirated

liquids or secretions from reaching and damaging the vacuum pump. Ideal for clinical use.

GIMA code	ASPEED ASPIRATORS	Power	Pump	Case
28244	Aspeed 15 l	230 V	single	metal
28245	Aspeed 22 l	230 V	double	metal
28280	Aspeed 2 15 l	230 V	single	plastic
28281	Aspeed 2 22 l	230 V	double	plastic

GIMA code	ACCESSORIES AND SPARES FOR ASPEED
28255	Hydrophobic bacterial filter
28258	Autoclavable jar 1l with cover
28259	Disposable suction liner
25480	Silicone tube 6x12 mm - roll of 30 m
28254	Adaptor to connect catheter to silicone tube
28261	Adaptor kit to use jar 1l (28258) with ASPEED manufactured before 2007

**STANDARD ACCESSORIES**  
Autoclavable polycarbonate jar 1,000 cc with safety valve (overflow protection)  
Disposable suction liner 1 l  
Antibacterial hydrophobic filter  
Sterile disposable cannula  
Sterile manual flow regulator  
Set of atoxic sterilizable silicone tubes  
Power Cable  
User Manual: GB, FR, IT, DE, ES

	ASPEED		ASPEED 2	
	28244	28245/6*	28280	28281
Operating voltage:	230 V-50 Hz *110-60 Hz		230 V - 50/60 Hz other voltage on request	
Bottle capacity:	1 l	1 l	1 l	1 l
High vacuum:	high flow	high flow	low flow	high flow
Air flow:	15 l/min	22 l/min	15 l/min	22 l/min
Adjustable vacuum level:	0 ÷ -0.85 bar (0 ÷ -85 kPa)			
Weight:	3.5 kg	4.2 kg	2.7 kg	3.4 kg
Case material:	metal		plastic	
Noise level:	53 dBA	63 dBA	63 dBA	63 dBA



28258  
Autoclavable Jar, h 19.2 cm  
Ø 10 cm top,  
9.7 cm base

28259  
Disposable suction liner

# ASPEED 3.0 PROFESSIONAL SINGLE PUMP ASPIRATOR

- 28279 ASPEED 3.0 ASPIRATOR 16 l/min - 1 l
- 28319 ASPEED 3.0 ASPIRATOR 16 l/min - 2 l

Portable, compact reliable aspirator ideal for small surgery. Piston type continuous cycle electric medical device. High vacuum low flow. No maintenance or lubrication.

MADE IN ITALY

TECHNICAL SPECIFICATIONS	
Operating voltage:	230 V - 50 Hz
Power consumption:	max 150 VA
Bottle capacity:	1 l (28279) or 2 l (28319)
High vacuum:	low flow
Air flow:	16 l/min
Adjustable vacuum level:	0 ÷ -0.65 bar (0 ÷ -65 kPa)
Size:	300x170xh 260 mm
Weight:	2.3 kg
Noise level:	65 dBA
Operating cycle:	continuous
Class:	II
Type:	BF

**STANDARD ACCESSORIES**  
Autoclavable polycarbonate jar 1,000 cc or 2,000 cc with safety valve (28258 or 28294)  
Disposable liner 1 l (28259) only for 28258  
Antibacterial hydrophobic filter  
Sterile disposable cannula  
Sterile manual flow regulator  
Set of atoxic sterilizable silicone tubes  
Power Cable  
User Manual: GB, FR, IT, DE, ES



28279

Autoclavable jar 1l or 2l can be used with both models



28319

CE 0051



28258

Disposable liner (28259) has to be used within jar 1l (28258) by removing the blue lid



28259

GIMA code	ACCESSORIES AND SPARES FOR ASPEED
28255	Hydrophobic bacterial filter - spare
28258	Autoclavable jar 1 l with cover
28294	Autoclavable jar 2 l with cover
28259	Disposable suction liner 1 l - spare
25480	Silicone tube 6x12 mm - roll of 30 m
28254	Adaptor to connect catheter to silicone tube

## SUPERVEGA BATTERY SUCTION ASPIRATORS

- 28243 SUPERVEGA BATTERY - plastic case - 16 l/min
- 28247 SUPERVEGA BATTERY WITH FOOTSWITCH - plastic case - 16 l/min
- 28190 SUPERVEGA BATTERY - plastic case - 36 l/min
- 28248 SUPERVEGA BATTERY WITH FOOTSWITCH - plastic case - 36 l/min

Professional, portable suction units for body, oral, nasal or tracheal liquids aspiration in adults or children. Supplied with three different operation options: AC/DC adapter, internal lead rechargeable battery and 12 V make it a versatile unit approved for NON-STOP operation without overheating. Visual and acoustic alarm indicating low battery level. Ergonomic handle ensures a comfortable and secure grip. Bottle with safety float control valve to prevent overflow.



MADE IN ITALY

TECHNICAL SPECIFICATIONS	
Suction power:	16 air l/min (28243), 36 air l/min (28190)
Max suction:	28243, 28247: -0.75 bar (563 mm/Hg), 28190, 28248: -0.80 bar (600 mm/Hg)
Operating Voltage:	100-240 V - 50/60 Hz
Battery autonomy:	approx 80 min (28243), 60 min (28190)
Recharging time:	240 minutes
Noise level:	63 dBA (28243), 65.5 dBA (28190)
Size - Weight:	350x210x180 mm - 3.5 kg (28243), 4.05 kg (28190)
Norms:	Class II Type BF EN 60601-1-1, EN 60601-1-2, EN 60601-1-11, 93/42 EEC



STANDARD ACCESSORIES
Bottle 1 l - autoclavable at 121°C
AC/DC universal adapter (100-240V - 50-60Hz)
Silicone tubing set
Anti-bacterial filter
Suction catheter
Cigarette lighter adaptor (12V 4A)
User manual (GB, IT, FR, DE, ES, GR, PL, RO, PT)

## SUPERVEGA 118 AND EVO BATTERY SUCTION ASPIRATORS

- 28240 SUPERVEGA 118 AMBULANCE BATTERY ASPIRATOR
- 28241 SUPERVEGA 118 BATTERY ASPIRATOR
- 28182 SUPERVEGA EVO AMBULANCE BATTERY ASPIRATOR
- 28183 SUPERVEGA EVO BATTERY ASPIRATOR

Electric medical and portable devices for nasal, oral and tracheal aspiration of body fluids in children or adults. Two or three options of operation: by 100-240 V power feeding, 12 V car adapter (28183 and 28241 only) or internal rechargeable battery. Equipped with a long-life brushless motor eliminating smell and coal residuals. **Large LCD (28182 and 28183 only)** Clear reading of vacuum values along with soft keys for vacuum adjustment increase the accuracy of aspiration.

**FEEDBACK system and RPM (28182 and 28183 only)**

System controls and manages the power of aspiration, providing a long autonomy to the lightweight lithium-ion battery and quite noise level during operation. Built-in engine RPMs control with basic electronics.

**PROXIMITY function: NO-TOUCH ON/OFF**

It prevents and avoids cross-contamination in-between patients.

**Various options of jars**

Standard autoclavable (121°C) Makrolon® polycarbonate, optional FLOVAC® disposable liners or autoclavable (143°C) APEC® polycarbonate.

In compliance with EN 60601-1-11 (only 28183, 28241) for use in the home healthcare environment and carries IP22 degree protection. The ambulance wall bracket is 10g dynamically tested according to the EN 1789:2007 European norm (only 28182, 28240).



MADE IN ITALY

Carrying handle

PROXIMITY

RPM FEEDBACK\*

LITHIUM BATTERY

LCD DISPLAY\*

AUTOMATIC VACUUM CONTROL

\*Only 28182, 28183



STANDARD ACCESSORIES	
Polycarbonate jar 1,000 ml with overflow valve system	
Silicone tube set with conical connector	
Universal power adaptor (100-240V - 50/60 Hz)	
12V car adaptor (only 28183, 28241)	
Support bracket for ambulance 20x16x16 cm (only 28182, 28240)	
Antibacterial filter	Carrying bag (only 28182, 28240)
Suction catheter	User Manual GB, FR, IT, DE, ES

TECHNICAL SPECIFICATIONS	
Motor:	Oil-less and maintenance-free piston pump
Power:	Internal rechargeable Lithium battery (14.8 V - 5.2 A) - Autonomy 70 min
	Car-ambulance adaptor (12 V - 4 A) - only 28183, 28241
	AC/DC adapter 110-240 V, 50-60 Hz - only 28183, 28241
	Recharge from support bracket - only 28182, 28240
Max vacuum (adjustable):	-0.75 Bar; -75 kPa; -563 mmHg
Max free air flow rate:	26 l/m (28182, 28183), 36 l/m (28240, 28241)
Size:	35x19x15 cm Weight: 2.7 kg
Duty cycle:	non stop operation (by mains or 12 V only)
Noise level min/max:	46.7/61.8 dBA (28182/83), 54.7/68.2 dBA (28240/41)

## ACCESSORIES FOR SUPERVEGA, SUPERVEGA 118, SUPERVEGA EVO

GIMA code	SPARE ACCESSORIES FOR SUPERVEGA, 118, EVO
28229	Hydrophobic, 99% antibacterial filter
28226	121°C autoclavable jar 1 l with cover and overflow system
28227	Cover and overflow valve system for 28226
28185	143°C autoclavable jar 1 l with cover and overflow system
28184	Cover and overflow valve system for 28185
28271	Flovac® disposable liner 1 l (cover + bag)
28268	Flovac® disposable liner 1 l (cover + bag) - box of 50
28270	Flovac® container for disposable liner 1 l

GIMA code	SPARE ACCESSORIES FOR SUPERVEGA, 118, EVO
25468	Silicone tube 6x10 mm - roll of 30 m
28252	Adaptor to connect catheter to silicone tube
	Suction catheter - see at page 51
28242	Battery for SuperVega/Tobi (28243*/28240) - spare
28251	Battery for SuperVega (28190/28243**) - spare
28238	Li-Ion battery for SuperVega 118 and Evo - spare
28276	Vacuum indicator for SuperVega line (not for Evo)
28218	2 pin British plug - optional

\*Up to S.N. 2141 (3 LEDs)

\*\*Since S.N. 3000 (1 LED)



# MINIASPEED BATTERY PRO SUCTION ASPIRATORS



- **28206 MINIASPEED BATTERY PRO - metal case - 30 l/min**  
High vacuum portable medical device for professional surgical aspiration.  
- it can operate at 12 V (car) power supply, rechargeable batteries or directly by mains supply  
- its two cylinders electro-compressor ensure high performances and long life  
- up to 45 min. of autonomy with fully charged battery  
- with 99% antibacterial hydrophobic filter - equipped with autoclavable jar with safety valve, disposable suction liner and carrying bag.
- **28207 CARRYING BAG for MiniAspeed Pro and Plus - spare**

Disposable suction liner inside autoclavable jar



28206

### TECHNICAL SPECIFICATIONS MINI ASPEED

Operating Voltage:	100-240 V 50/60 Hz AC - 14 V DC 4.28 A
Size:	370x100x240 mm
Weight:	5.8 kg (include kit)
Max suction:	-0.85 bar
Suction power:	30 air l/min
Noise level:	65 dBA
Norms:	MDD 93/42/ECC (class IIa - annex IX) IEC 60601-1, UNI EN ISO 10079-1

### STANDARD ACCESSORIES

Autoclavable jar 1000 cc with safety valve	Anti-bacterial hydrophobic filter
Silicone tubing set Ø 6x12 mm	Multivoltage battery charger
Disposable suction liner	Cigarette lighter power cord.
Sterile cannula	Shoulder carrying bag
	User manual (GB and IT)



# MINIASPEED BATTERY EVO PROFESSIONAL SUCTION ASPIRATORS

- **28282 MINIASPEED EVO BATTERY SUCTION - 1 l**
  - **28283 MINIASPEED EVO BATTERY SUCTION - 1 l for ambulance**
  - **28284 MINIASPEED EVO BATTERY SUCTION - 2 l**
  - **28278 MINIASPEED EVO BATTERY SUCTION - 2 l for ambulance**
- Professional portable high flow - high vacuum aspirators with integrated rechargeable batteries. It works at 12 V power supply with batteries or directly by mains supply, continuously at 110-230 V while recharging batteries.  
Up to 45 minutes of autonomy with fully charged battery.

### TECHNICAL SPECIFICATIONS

Operating voltage:	with internal battery DC 12 V - 4 Ah with power supply 100÷240 V ~ 50/60 Hz - 14 VDC 4,28A
Power consumption:	max 50 W
Battery autonomy:	about 45 minutes, recharging time approx 6 hours
Size:	134x378xh 263 mm
Weight:	4.7 kg (5 kg version for ambulance)
Bottle capacity:	1,000 or 2,000 ml
Flow:	30 air litres/min
Noise level:	65 dBA at 1 m
Operating cycles:	continuous (45 min battery autonomy)
MAX vacuum:	0 ± 85 kPa
Norms:	MDD 93/42/EEC (Class IIa - annex IX) EN60601-1 (IEC 60601-1) / EN60601-1-2 (IEC 60601-1-2) UNI EN ISO 10079-1/ UNI CEI EN ISO 14971
Degree of protections against ingress of liquids:	IP34d (IEC 529) Class II - Type B



Wall bracket for ambulance with recharging system



28282



### STANDARD ACCESSORIES

Autoclavable 1 or 2 l jar with safety valve	2 bacterial hydrophobic filters
Sterile disposable cannula CH14	User manual: GB, IT, FR, DE, ES
Sterile disposable manual regulator	Power supply cord - 2 m
Disposable silicone liner 1 l (28282-3 only)	Shoulder carrying bag
Wall bracket for ambulance (only 28278, 28283)	Multivoltage battery charger
Cigarette lighter power cord (28282, 28284 only)	Silicone tubing set Ø 6x12 mm

# ACCESSORIES FOR MINIASPEED BATTERY PRO AND EVO

GIMA code	ACCESSORIES AND SPARES FOR MINIASPEED
25480	Silicone tube 6x12 mm - roll of 30 m
28254	Adaptor for catheter
28258	Autoclavable jar 1,000 ml (with cover)
28259	Disposable suction liner 1 l for use with 28258
28294	Autoclavable jar 2,000 ml (with cover) for 28278, 28284

GIMA code	ACCESSORIES AND SPARES FOR MINIASPEED
28255	Hydrophobic 99% bacterial filter
28153	Cylinder 3A1062 - spare
28263	Battery
28256	Power supply with cable

## SUPERVEGA SUCTION ASPIRATOR ON TROLLEY

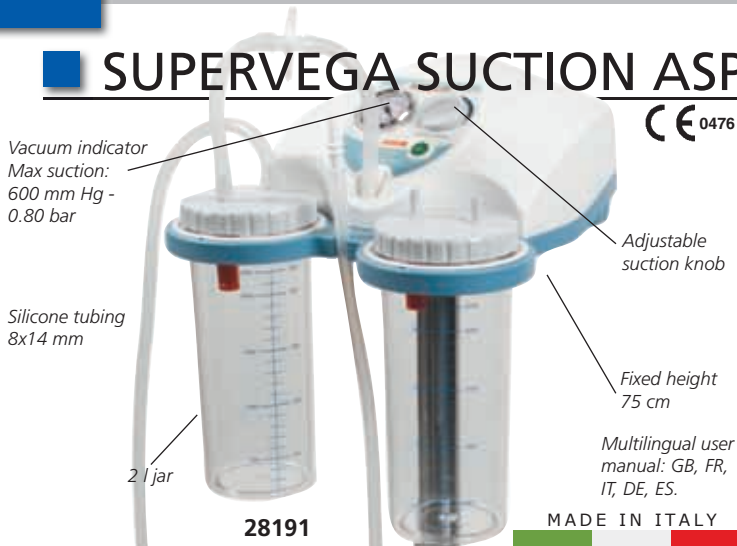

- 28191 SUPERVEGA on trolley - suction 2x2 l jar
  - 28192 SUPERVEGA on trolley - suction 2x2 l jar with footswitch
- Continuously adjustable vacuum, with indicator. Silicone connection tube 8x14 mm. 2 jars 2 l, made of sterilizable polycarbonate (autoclavable at 121°C). Approved for NON-STOP operation without overheating. Suction power: 40 air litres/min. Steel painted frame, fitted with 5 star base.

**TECHNICAL SPECIFICATIONS**

Size: 38x36xh 92 cm    Weight 6.2 kg  
 Operating voltage: 220-230 V - 50/60 Hz; other on request  
 Power consumption: 110 VA  
 Maximum suction: -0.80 bar (600 mm Hg)  
 Flow: 40 air litres/minute  
 Operating cycle: continuous  
 Noise level: 61.5 dBA  
 Norms EN 60601-1-1, EN 60601-1-2 - C €93/42 EEC - Class II - Type B



## SUPERVEGA BATTERY SUCTION ASPIRATOR ON TROLLEY



- 28193 SUPERVEGA BATTERY on trolley - suction 2x2 l jar
  - 28197 SUPERVEGA on trolley - suction 2x2 l jar with footswitch
- Professional portable suction unit for the aspiration of body liquids, oral, nasal and tracheal aspiration in adults or children. Suction power of 36 l/min. Double collection jars on a stand with five castors for easy transport. Two different working options: AC/DC adapter or rechargeable battery make it a versatile suction unit approved for NON-STOP operation without overheating. Visual and acoustic alarm indicating low battery level, vacuum-meter (bar & kPa) and vacuum regulator.

**TECHNICAL SPECIFICATIONS**

Operating voltage: 100-240 V - 50/60 Hz  
 Internal rechargeable Pb battery: 12V - 4A  
 Battery autonomy: 60 min  
 Recharging: 240 min

Operating cycle: continuous with AC/DC  
 Flow: 36 air litres/minute  
 Noise level: 65.5 dBA  
 Size - Weight: 32x30xh 99 cm - 7.9 kg

MADE IN ITALY

Five antistatic wheels with brake  
 User manual: GB, FR, DE, IT, ES



## ACCESSORIES AND SPARES FOR CLINIC PLUS, HOSPI PLUS, SUPERVEGA ON TROLLEY

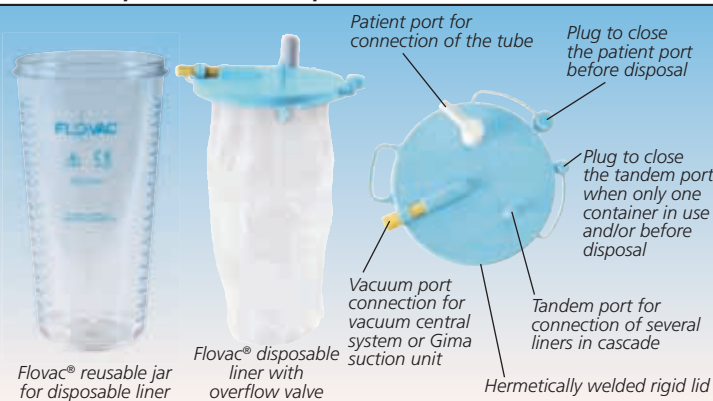

### AUTOCLAVABLE JARS WITH OVERFLOW VALVE SYSTEM

Equipped with screw cover with handle for easy grip, autoclavable silicone o-ring for tight seal, overflow valve system integrated in the cover, clear graduated scale in ml with 100 or 200 ml intervals. Suitable for central vacuum systems and Gima suction units. Available in two types of polycarbonate, Makrolon® and Apec®.

GIMA code	AUTOCLAVABLE JARS	Compatible with
<b>JARS IN MAKROLON® AUTOCLAVABLE UP TO 121°C</b>		
28236	Jar 2 l with cover - Makrolon®	2 l aspirators
28227	Cover for jar 2 l	28236
28228	Jar 4 l with cover - Makrolon®	4 or 5 l aspirators
28223	Cover for jar 4 l	28228
28221	Jar 5 l with cover - Makrolon®	4 or 5 l aspirators
28225	Cover for jar 5 l	28221
<b>JARS IN APEC® AUTOCLAVABLE UP TO 143°C</b>		
28186	Jar 2 l with cover - Apec®	2 l aspirators
28184	Cover for jar 2 l	28186
28187	Jar 5 l with cover - Apec®	4 or 5 l aspirators
28188	Cover for jar 5 l	28187
<b>ANTIBACTERIAL, HYDROPHOBIC FILTERS</b>		
28237	Hydrophobic, antibacterial filter	D, E
28239	Hydrophobic, antibacterial filter	A, B, C

### FLOVAC® DISPOSABLE LINERS

Equipped with polyethylene disposable liner, hydrophobic filter, overflow system, reusable container with clear graduated scale in ml with 50 ml intervals.

GIMA code	FLOVAC® JARS AND DISPOSABLE LINERS	Compatible with
28272	Reusable jar for disposable liner 2 l	B, C, D, E (only 2 l)*
28273	Disposable liner 2 l cover+bag	28272
28274	Reusable jar for disposable liner 3 l	B, C, D, E (only 2 l)*
28275	Disposable liner 3 l cover+bag	28274
<b>SPARES</b>		
25482	Silicone tube 8x14 - roll of 30 m	A, B, C, D, E
28253	Adapter to connect catheter to silicone tube	25482
	Suction catheter see at page	28253
28276	Vacuum indicator Ø 50 mm - spare	A, B
28277	Vacuum indicator Ø 60 mm - spare	C, D, E
28265	Bottom base	C, E
28266	Bottom base	B
28267	Bottom base	D
28217	2 Pin British Plug - optional	All

\*Suitable also for MPR line using optional 2 l ring

LEGEND: A: SuperVega on trolley, B: Clinic, C: Clinic Plus, D: Hospital, E: Hospi Plus

# HIGH VACUUM, HIGH FLOW HOSPITAL SUCTION ASPIRATORS



**CLINIC PLUS and HOSPI PLUS**

Size: 460x850x420 mm  
Weight: 20 kg

2 antistatic castors and 2 with brake

MADE IN ITALY



**CLINIC PLUS and HOSPI PLUS MPR**

4 antistatic castors with brake

**MPR SYSTEM**  
Multi purpose rail

Customized Hospi Plus MPR with 1x2 l jar, 1x5 l jar and safety trap

**28151**

Multipurpose stainless steel rail for maximum versatility allows to hang any accessory. Suitable for MPR models only

**28154, 28155, 28156**

Rings for: 2 or 5 l autoclavable jars, 2 or 3 l Flovac

Designed for professional aspiration of bodily fluids, tissues or bones of patients during or after surgery.

Oiless and maintenance free piston type pumps provide high performances. Excellent suction capacities and max vacuum built up within a few seconds. Available with vacuum gauge and autoclavable jars made in Makrolon® with 200 ml (2 l jar) or 500 ml (4 or 5 l jars) graduation and 2-3 litres Flovac jars with disposable liners.

**Wide range of versions with different features**

- 60 l/m (Clinic Plus) or 90 l/m (Hospi Plus) flow rate;
- 2, 4 or 5 l jars;
- MPR system for versatility;
- footswitch and flow direction diverter.

**High standards of safety in overflow protection system**  
Double security valve integrated in the jar and hydrophobic filter (all models), safety trap bottle (only MPR models).

**MPR (Multi Purpose Rail) models**

This system enhances the versatility for easy and quick exchange of different accessories, with no need for tools. Equipped with five connections for rings of various diameters to fit jars of different sizes and types (2l, 3l, 5l), cannula holders and safety trap bottle.

MAIN APPLICATIONS		
EMERGENCY DEPT. GENERAL SURGERY	GYNAECOLOGY NEUROSURGERY OBSTETRICS	OPERATING THEATRE DENTAL PRACTICE



Clinic Plus Basic and Hospi Plus Basic



Clinic Plus Full and Hospi Plus Full with foot switch and electronic flow direction regulator



Multipurpose rail with 5 locking slots offers versatility to operators in changing accessories

	TECHNICAL SPECIFICATIONS					
	CLINIC PLUS		HOSPI PLUS			
Operating voltage:	230 V - 50/60 Hz or 110 V - 60 Hz		230 V - 50/60 Hz or 110 V - 60 Hz			
Maximum suction:	- 0,90 bar (675 mmHg)		- 0,90 bar (675 mmHg)			
Operating cycle:	continuous		continuous			
Flow:	60 l/min		90 l/min			
Power:	230 VA		385 VA			
Noise level:	51.7 dBA		46.4 dBA			
Norms:	EN 60601-1-1, EN 60601-1-2 93/42 EEC		EN 60601-1-1, EN 60601-1-2 93/42 EEC			
<b>STANDARD ACCESSORIES CLINIC PLUS and HOSPI PLUS</b>						
	Clinic, Hospi basic	Clinic, Hospi full	Clinic basic MPR	Clinic full MPR	Hospi basic MPR	Hospi full MPR
121°C autoclavable jar with overflow valve system (2, 4 or 5 l)	2	2	2	2	2	2
Rings to accommodate 5 l jars	-	-	2	2	2	2
Safety Trap Bottle (220 ml)	-	-	1	2	1	2
Antibacterial & Hydrophobic Filter (single-patient)	1	1	1	1	2	2
Autoclavable silicone tubes Ø 8x14 mm length 150 cm	1	1	1	1	2	2
Conical Connector Ø 10-11-12mm	1	1	1	1	2	2
Air suction inlet	1	1	1	1	2	2
Footswitch with intermittent or continuous operation	-	1	-	1	-	1
Change-Over System from jar to jar by soft-touch keys	-	1	-	1	-	1
Power Cord with Schuko plug	1	1	1	1	1	1
Multilingual manual: GB, FR, IT, ES ,DE, GR, PL, RO	1	1	1	1	1	1

Voltage		SUCTION ASPIRATORS CLINIC and HOSPI PLUS	Autoclavable Jars	Foot switch	Flow direction diverter*
230 V	110 V				
<b>28194</b>	<b>28118</b>	CLINIC Basic	2x2 l	-	-
<b>28195</b>	-	CLINIC Full	2x2 l	yes	yes
<b>28196</b>	-	CLINIC Basic	2x4 l	-	-
<b>28198</b>	<b>28119**</b>	CLINIC Full	2x4 l	yes	yes
<b>28159</b>	-	CLINIC Basic MPR	2x5 l	-	-
<b>28160</b>	-	CLINIC Full MPR	2x5 l	yes	yes
<b>28200</b>	-	HOSPI Basic	2x2 l	-	-
<b>28203</b>	-	HOSPI Full	2x2 l	yes	yes
<b>28201</b>	-	HOSPI Basic	2x4 l	-	-
<b>28204</b>	<b>28120**</b>	HOSPI Full	2x4 l	yes	yes
<b>28161</b>	-	HOSPI Basic MPR	2x5 l	-	-
<b>28162</b>	-	HOSPI Full MPR	2x5 l	yes	yes

\*Allows to direct suctioned liquids to any of the 2 jars \*\*with 2x5 l jars

GIMA code	ACCESSORIES FOR CLINIC/HOSPI PLUS MPR
<b>28150</b>	Safety trap bottle 220 ml - spare
<b>28151</b>	Multipurpose stainless steel rail - optional
<b>28154</b>	Ring for 2 l autoclavable jar - optional
<b>28155</b>	Ring for 5 l autoclavable jar - spare
<b>28156</b>	Ring for 2 or 3 l Flovac jar - optional

# MAXI ASPEED HIGH FLOW ASPIRATOR FOR HOSPITAL USE



28288  
28291  
28292

MADE IN ITALY



28285  
28286  
28289



Telescopic handle

Foot switch integrated with 28286, 28288, 28290, 28292

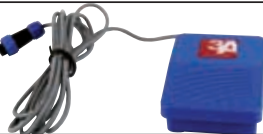

## MAXI ASPEED SURGICAL ASPIRATORS

Surgical aspirators for aspiration of body liquids in operating theatres and hospitals.

### Easy to carry

Equipped with 4 antistatic wheels with brake and carrying telescopic handle.

### Developed to run continuously

Made of highly heat resistant, electrically insulated plastic material in conformity with latest European safety standards. Vacuum regulator with BAR/PSI vacuometer and automatic flow direction regulator to easily switch from a jar to the other. Supplied with 2 autoclavable polycarbonate jars with safety valve (overflow protection), set of atoxic sterilizable silicone tubes, antibacterial hydrophobic filters (2) and multilingual manual (GB, FR, IT, DE, ES).

GIMA code	MAXI ASPEED	Jar	Power	Foot switch	Flow direction diverter*
28285	Maxi Aspeed 60 l	2x2 l	230 V	-	yes
28286	Maxi Aspeed 60 l	2x2 l	230 V	yes	yes
28288	Maxi Aspeed 60 l	2x4 l	230 V	yes	yes
28289	Maxi Aspeed 90 l	2x2 l	230 V	-	yes
28290	Maxi Aspeed 90 l	2x2 l	230 V	yes	yes
28291	Maxi Aspeed 90 l	2x4 l	230 V	-	yes
28292	Maxi Aspeed 90 l	2x4 l	230 V	yes	yes

\*Allows to direct suctioned liquids to any of the 2 jars

### ACCESSORIES

28294	Autoclavable jar 2 l with safety valve	
28295	Autoclavable jar 4 l with safety valve	
28297	Hydrophobic antibacterial filter	
25482	Silicone tube - 8x14 mm - roll of 30 m	
28293	Pre-cut silicone tube 8x14 - 1.3 m	
28253	Adapter to connect catheter to silicone tube - spare	
	Suction catheter see page 51	

TECHNICAL SPECIFICATIONS			
Operating voltage:	230 V - 50/60 Hz	Noise level:	50-60 dBA
Air flow:	60 or 90 l/min	Size:	470x580x560 mm
Operating cycle:	continuous	Weight:	15 kg (60 l), 17 kg (90 l)
Adjustable vacuum level:	0-0.90 bar (0-90 kPa)	MDD class:	Ila

# MEDICAL GRADE SILICONE TUBES FOR EXTERNAL USE



MADE IN SPAIN

**SILICONE TUBES for external medical use - silicone 100%**  
Suitable for autoclaving (135°C - 2.2-2.5 bar) and Gamma Sterilization. Resistant to hot air up to 200°C. Infra-red vulcanization. Hours treatment at 200°C temperature in special oven. Anti-adherent, avoid incrustation and coagulation. Medical Grade - Transparent - Odourless

TECHNICAL SPECIFICATIONS			
Raw material:	HTV-R-401/60 S - WACKER (D)	Colour:	translucent
Hardness:	60° ±5% Shore - DIN 53505	Density:	1.17 g/ccm - DIN 53479A
Tensility:	10.8 N/mm <sup>2</sup> - DIN 53504 S1	Stretch:	490/530% - DIN 53504S1
Tear resistance:	34-35 N/mm - ASTM D 624 B		
Reverse pull elasticity:	51% - DIN 53512		
Compression set:	(22h/175°C): 30-15% - DIN 53517		

Made in European Union according to: US PHARMACOPOEIA XXI  
EUROPEAN PHARMACOPEA DIN 58367 - DIN 58362 - DIN 13098- FDA 177.2600 - BGA XV part A and B - BGA IX part B

GIMA code	Internal diameter x external diameter	Thickness mm	Minimum order
25450	1x3 mm	1 mm	roll of 100 m
25451	2x4 mm	1 mm	roll of 100 m
25452	3x5 mm	1 mm	roll of 100 m
25453	4x6 mm	1 mm	roll of 100 m
25455	6x8 mm	1 mm	roll of 30 m
25458	3x6 mm	1.5 mm	roll of 30 m
25459	4x7 mm	1.5 mm	roll of 30 m
25460	5x8 mm	1.5 mm	roll of 30 m
25461	6x9 mm	1.5 mm	roll of 30 m
25462	7x10 mm	1.5 mm	roll of 30 m
25466	4x8 mm	2 mm	roll of 30 m
25467	5x9 mm	2 mm	roll of 30 m
25468	6x10 mm	2 mm	roll of 30 m
25469	8x12 mm	2 mm	roll of 30 m
25470	10x14 mm	2 mm	roll of 30 m
25474	5x10 mm	2.5 mm	roll of 30 m
25475	7x12 mm	2.5 mm	roll of 30 m
25476	8x13 mm	2.5 mm	roll of 30 m
25477	10x15 mm	2.5 mm	roll of 30 m
25480	6x12 mm	3 mm	roll of 30 m
25481	7x13 mm	3 mm	roll of 30 m
25482	8x14 mm	3 mm	roll of 30 m
25483	9x15 mm	3 mm	roll of 30 m
25484	10x16 mm	3 mm	roll of 30 m
25485	12x18 mm	3 mm	roll of 30 m
25488	8x15 mm	3.5 mm	roll of 30 m
25491	10x20 mm	5 mm	roll of 30 m
25495		made to order	500 m

**MADE TO ORDER SILICONE TUBES\***  
We can manufacture any size (minimum order 500 m)

\*delivery 30 days

# GELID COAGULATIVE POWDER

## • 28141 GELID COAGULATIVE POWDER 50 g - box of 25

Super absorbent polymer powder used to turn infected medical liquid waste into a gel-like substance. Mixed with liquid waste, it solidifies and reduces the risk associated with spills of organic liquids. 50 g of product have an absorption capacity of 3000 ml. It can be used for surgical and bronchial suction system (canister or bags); canister for laboratory's liquid; dialysis liquid...  
Material: sodium polyacrylate cross-linked. Packed in aluminum pouch.



28141

## HAND SUCTION PUMP

### • 28131 SINGLE PATIENT HAND SUCTION PUMP

Light and portable manual suction unit operated by one hand only to let the other hand free for important duties. Simple operation. Adjustable stroke knob provides different suction pressures.



Supplied with 550 mmHg handle, 300 ml canister, child and adult catheter

28131

#### TECHNICAL SPECIFICATIONS

Vacuum after 1 min at 20kPa vacuum:	≥ 15 kPa
Vacuum after 6 times suction:	≥ 20 kPa
Max. vacuum:	≥ 39.9 kPa
Disposable container volume:	300 ml
External cap:	Ø 17 mm
External catheter connection:	Ø 17 and 9 mm
Stroke adjustment:	turn to 50% or 100%
Size - weight:	52x42x44 cm - 230 g

## HAND SUCTION PUMP

### • 28180 HAND SUCTION UNIT

Designed to provide quick and effective pharyngeal and tracheal suction for emergency use. The adjustable stroke knob provides different suction pressure. Supplied with 250 ml bottle and 2 non sterile adult cannulas 17 cm (Ø 6 mm) and 19 cm (Ø 10 mm).

### • 28181 SPARE ADULT KIT

Includes 250 ml bottle and 2 non sterile adult cannulas 17 cm (Ø 6 mm) and 19 cm (Ø 10 mm).



Supplied with multi-lingual box and manual: GB, FR, IT, ES, DE, PT, PL, GR, Arabic.

28180

#### TECHNICAL SPECIFICATIONS

Max vacuum:	-400 mmHg	Weight: 260 g
Peak free airflow:	>20 l/min	Size: 230x60x190 mm
External diameter of catheter connection:	10 and 6 mm	

## SPENCER JET 300D

### • 28177 JET COMPACT PORTABLE SUCTION UNIT

Extremely compact suction device to remove fluids from the airway or respiratory system support. The negative pressure draws fluids through disposable tubing that is connected to the collection container. Easy view of the setted vacuum thanks to the LED indicators. Classification ISO: high vacuum / high flow.

Supplied with power cable, battery, disposable container with filter, disposable patient tube.

### • 28178 DISPOSABLE CONTAINER 300 ml with filter

### • 28179 POWER ADAPTER



28177



#### TECHNICAL SPECIFICATIONS

Size - Weight:	245x70x185 mm - 1.60 kg	IP grade	IP 12
Vacuum range:	from 50 to 550 mmHg	Battery:	12 V DC Ni-MH
Flow (free flow):	32 l/min	Battery operative time:	30 min ON, 30 min OFF
Noise level:	70 dB	Battery recharging time:	5 h
Electrical connector	100-240 VAC 47-63 Hz	Container capacity:	300 ml
Requirement:	0.75 A max: 12 VDC	Patient tube length:	1 m

## HAND/FOOT/KNEE SUCTION PUMP

### • 28220 TOBI MANUALE - manual suction aspirator

Tobi Manuale is simple to operate pressing pedal by foot, hand or knee. It is used to clear patient's airways safely and efficiently, anytime, anywhere. Precision and solidly built to assure long service life. Polycarbonate suction bottle with capacity 0.4 l, autoclavable at 121°C and spill-over protection. Bacterial filter included.

Multilingual user manual: GB, FR, IT, DE, ES, PT.

### • 28219 BOTTLE 0.4 l - spare

### • 28229 HYDROPHOBIC ANTIBACTERIAL FILTER - spare

MADE IN ITALY

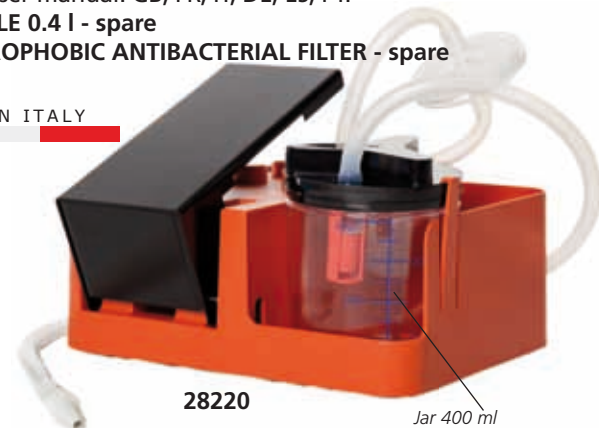

28220

Jar 400 ml

#### TECHNICAL SPECIFICATIONS

Weight: 1.15 kg	Max suction -0.40 bar	Bottle capacity: 0.4 l
Size: 225x165x85 mm	Suction power: 22 l/min	

## ACCESSORIES FOR ASPIRATORS



28260

GIMA code	STAINLESS STEEL OR BRASS C/P ASPIRATION TUBES
28262	S/S Bierer Aspiration tube Ø 8 mm
28264	S/S Bierer Aspiration tube Ø 12 mm
	Supplied with removable connection cannula
28260	Set of 7 brass chrome plated uterine aspiration cannulas for abortion: 4 cannulas with side suction end (Ø 5, 6, 8, 9 mm), 3 cannulas with front suction end (Ø 7, 10, 11 mm) and one handle

■ S/S FRAIZER, ROSEN, NOVAK SUCTION CANNULA SUCTION CATHETERS

See page 46  
See page 51

## YANKAUER CANNULA

Ready-to-use rigid cannula for suction of fluids in surgical field. Anatomical and anti-slip handle for easy grip. Transparent to control the flow of suction fluids. Open tip with one central and four lateral holes (Ø 20 mm). Flexible, transparent and non-conductive suction tube. Single use. Phthalates and latex free. Packed in single pouch. Class IIa, sterile.

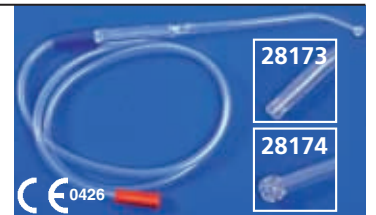

28173

28174



• 28173 YANKAUER CANNULA with open tip and suction tube - 25 cm - box of 50  
• 28174 YANKAUER CANNULA with bulb tip and suction tube - 25 cm - box of 50

## GIMA LED COLPOSCOPE

• **29600 COLPY - GIMA LED COLPOSCOPE**  
Easy to use LED colposcope mounted on a 5 wheels base (Ø 41 cm).

### COLPOSCOPE TECHNICAL SPECIFICATIONS

Magnifying: 8.2X with standard 10X eyepieces  
Field: 35 mm  
Optic system: stereo with inter-pupil adjustment and optic head at 45°  
Illumination: LED bulb  
Working distance: 28 cm  
Interpupillary distance: 48-77 mm  
Green filter  
Operating voltage: 100-240V, 50-60 Hz  
Norms: CLASS I Type B - IEC 601-1 CE 93/42/EEC.

• **29601 CAMERA CONNECTOR for 29602**

To connect a camera with standard "C mount" to GIMA colposcope.

• **29602 MC1 PAL CAMERA - for Colpy**  
Fit the camera to one eyepiece and connect the video cable to a high definition monitor. Includes 29601.

• **29603 DL1 DIGITAL - USB 2.0 CAMERA with grabbing software for Colpy**  
Fitted on one eyepiece, allows to show image on PC through USB connection, becoming a high definition videocolposcope. Includes 29601

### TECHNICAL SPECIFICATIONS - 29602

Camera sensor: 1/3" CCD  
Resolution: 480 lines  
Power: 230 V - 50/60 Hz  
RCA video composite output 3 m cable  
Head size: 38x40x70 mm

### TECHNICAL SPECIFICATIONS - 29603

CMOS 1/3" sensor  
Max resolution pictures 1280x1024 pixels  
Max resolution movie 440x480 pixels



Adjustable height observation 73-104 cm

MADE IN ITALY

29600

## ALLTION LED COLPOSCOPE

• **29612 ALLTION LED COLPOSCOPE - 9X**

• **29613 ALLTION LED COLPOSCOPE**

3,75X, 7X, 15X -> 28,000 LUX

High quality and complete colposcopes, with excellent optics and cold, longlife white light.

Compact, lightweight and easy to use offers superior quality at a competitive price. A special universal Teflon® ball joint gives user 360° easy motion for gross focus. Comes assembled, ready for use.  
Manual: GB, IT.

### TECHNICAL SPECIFICATIONS

Magnification 9X (29612) or 3,75X, 7X, 15X (29613)  
Focus length: 316 (29612) or 300 mm (29613)  
Field of view: diameter 22 mm or 30.93/15.50/7.64  
Depth of field: > 4 mm (29612) or 18/4/2 mm (29613)  
Light intensity: > 28.000 lux  
Interchangeable adjustable eyepiece 12.5X  
Illumination: longlife 5.9V / 5W LED  
Superior optics with individually adjustable eyepiece  
Built-in rheostat for brightness adjustment  
Easily changeable, LED bulb  
User-selectable built-in green filter  
Two (gross/fine) focus adjustment handles  
Two (gross/fine) height adjustment handles (838-1194 mm)  
Smooth action control  
Main Power: 110V/220V

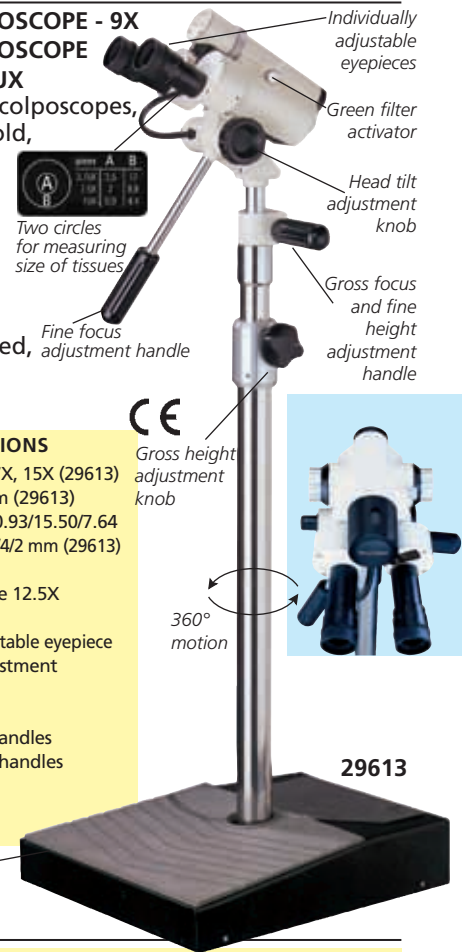

Two circles for measuring size of tissues

Fine focus adjustment handle

Gross height adjustment knob

360° motion

29613

Roller base for easy movement

## LED VIDEO COLPOSCOPES

• **29620 COLPRO LED VIDEO COLPOSCOPE**

• **29622 COLPRO LED VIDEO COLPOSCOPE - FULL HD**

The video colposcopes COLPRO are the perfect combination of an advanced video technology and the feedback received from gynaecologists, users and stakeholders. They are known for their ruggedness and versatility and they provide high resolution images of cervix and genital area for effective colposcopy diagnosis and treatment.

**5 levels of light intensity** to observe finest changes in tissue structure.

**Electronic Green Filter:** 4 different grades (5 for HD) ensure an optimal observation without any light loss.

**5 image colours settings** that guarantee best colour differentiation in epithelium.

**Mirror and E-flip image:** facility to change the direction of the image from left to right horizontally (mirror) or from upward to downward vertically (E-flip).

**Gamma processor:** assures high quality image processing for better visualization of vessels and tissue structure.

**Magnification up to 55 times and Auto-focus:** the colposcope focuses even if the patient moves. 1-55X (29620), 1-45X (29622).

**Remote control** allows to control the functions even from a distance.

**Freedom of connectivity:** can be connected to a TV or a monitor and to PC via USB. 2 video outputs can be taken on 2 different screens simultaneously.

**User friendly design:** ergonomic and user friendly design, easy to move. Height adjustable to have best positioning for colposcopy procedure.

**Maintenance free, shadowless LED light source**

• **72708 SONY LMD LCD MEDICAL MONITOR - 15" - support included**



29620

EMI/EMC tested

### TECHNICAL SPECIFICATIONS

Image processor: Sony Japan colour CCD  
Pixels: 1,200,000 (29620)  
2,000,000 (29622)  
Resolution: 825 TV Lines (29620)  
1,000 TV Lines (29622)  
E-flip: yes  
Mirror image: yes  
Electronic Shutter: automatic  
S/N ratio: >48 db (29620), >50 db (29622)  
Illumination: high MCD super bright white shadowless LED light  
Colour temperature: 7,000° K  
Test timer: yes  
Multigrade green filter: yes (4 grades, 5 for HD)  
Blue filter: yes  
Focus: automatic and manual  
Focus distance: 20-30 cm  
Zoom: 1-55X (29620), 1-45X (29622)  
Viewing area: Ø 170 mm - 10 mm  
Depth of view: Ø 200 mm - 5 mm  
Magnification display: Yes  
Average LED lamp life: 50,000 hours  
Video output: BNC and SVHS (both)  
YPBPR and DVI (29622 only)  
Safety standard: complies to IEC 60601 including EMC  
Power supply: 100-240 VAC, 50/60 Hz  
Made in Australia

## COLPOSCOPY IMAGE, VIDEO & PATIENT DATA MANAGEMENT SOFTWARE

• **29621 COLPOSCOPY SOFTWARE FOR COLPRO COLPOSCOPE AND COLPY WITH DIGITAL CAMERA**

A powerful IT tool in the hands of our busy gynaecologists to manage not only videos, images, clinical data and details of the patients, but also to provide them an opportunity to store, edit, burn on CD or DVD, print the detailed reports and use graphical data for presentation. Multilingual software (GB, ES, IT, DE, FR, PT, SE, NL, GR, Arabic). Footswitch for capturing and saving images.

This software supports composite and SVHS video output with help of video cable with RCA male connector.

Compatible with Windows 7 (64-bit) / XP / Vista, Windows 8 and 10 Operating Systems  
Easy to install and maintain. Password protected log-in to ensure data privacy

Enormous level of live recording facilities and image capturing at very high pixels simultaneously with just a click

Various kinds of colposcopy video clippings, movies, images for reference and education purpose have been incorporated in the software. Print out of reports with relevant details can be prepared for future follow-up of the patient

Comparison mode with linked images

Forensic examination & sexual abuse

Leep/Lieitz approach to treat high grade dysplasia

Cryo surgery report

Statistical data representation with graph

Multiformat 1-2-3-4 images diagnosis report

HAMMOND graph (biopsy graph)

Marking and highlighting



## LED VIDEO COLOSCOPES WITH CAMERA

- 29624 AC-2311 LED VIDEO COLPOSCOPE WITH CAMERA
- 29625 AC-2311DA LED VIDEO COLPOSCOPE L-SHAPED ARM WITH CAMERA

**- Superb optical features:**

- 1 - high resolution and good contrast
- 2 - real 3-dimensional precise image reproduction
- 3 - large depth of field
- 4 - wide field of view

Apochromatic optics design can correct the chromatic aberration of three types of coloured light effectively. It ensures the reduction and saturation of image colour and improves resolution, contrast and view depth of image.

**- 3-step magnification (3.75X - 7.5X - 15X)**

Provides larger magnifying range and more selection from lowest magnification for an overview to high magnification for precise and close inspection and treatment.

**- Two optical circles for quick measuring size of tissue**

**- Integrated green filter**

It can help to recognize blood vessels

**- LED illumination**

LED coaxial illuminator provides pure white colour light similar to sunlight to show real colour. Bulb life over 10,000 hours/10 years for long lasting performance. It saves your cost for the spare bulbs & electric charge.

**- Integrated camera**

The images from integrated video camera can be transferred directly into a monitor or a TV, into a computer with USB adapter or stored into a hard disk recorder.

**- Full HD (1920x1080 p) HDMI output**

**- Ergonomic design for comfortably long time precision operation**

Supplied assembled and ready for use with manual in GB, FR, IT.

• 29627 SOFTWARE FOR LED VIDEO COLOSCOPES (29624-5)

HDMI capture card & professional colposcopy software set including: external capture card, software and driver U-Disc, 2 HDMI cables, HDMI connector, dongle for connecting AC-2311 to the desktop computer (or laptop) & monitor at the same time.

The software allows to take and collect images for every inspection in order to analyze, diagnose and detect diseases. It can be used in colposcope inspection and dynamic observation of operation treatment.

**Features:**

- course for displaying, freezing, capturing and deleting image
- taking and collecting 1 to 100 colour images for every inspection
- operating system: Windows 7, Windows 8, Windows 10



TECHNICAL SPECIFICATIONS	
Total magnification:	3.75X, 7.5X, 15X, 300 mm focal length
Field of View:	Ø 79 mm, 39 mm, 19 mm
Depth of Field:	4.5 mm, 1.13 mm, 0.76 mm
Light intensity:	>25,000 LUX
Working height mm:	950 to 1250 (29624) - 950 to 1150 (29625)
Individually adjustable eyepiece:	16.7X
Right eyepiece with built-in two circles to measure the size of the problem you see	
Built-in rheostat for brightness adjustment	
User-selectable built-in green filter for enhanced contrast	
LED bulb is easily changeable	
Fine focus adjustment handles	
Two (Gross/Fine) height adjustment handles	
Power supply:	adapter input AC 100-240 V, 50-60Hz, output DC 12V3A
Weight:	8.5 kg (29624), 9 kg (29625)

175 standard atlas helpful to contrast, analyze and diagnose  
 Software mark on images  
 Mark on pathological changes image, add remark, measure pathological change size and magnify partially or totally  
 Input of clinic symptom  
 Printing of 19 kinds of reports, RCI evaluation function  
 Cases information search and editing  
 Cases be searched by name, case number, age, date and be added, deleted, edited, memorized and reviewed



## AMNIOCENTESIS NEEDLES

For transabdominal sampling of amniotic fluid (usually between 15<sup>th</sup> and 18<sup>th</sup> pregnancy well) for prenatal diagnosis of genetic disorders of the foetus.

It is also used for cytogenetic and biochemical studies. Accurate sharpening of the needle allows an easy and atraumatic insertion. Its mandrel is provided with an ultrasound detectable tip allowing an echo-guided insertion, and it is colour coded for an easy identification of the needle size. The needle is provided with an adjustable stopper to determine insertion depth, and with a female luer lock connector to collect the amniotic fluid through a syringe.



GIMA code	AMNIOCENTESIS NEEDLES - STERILE - box of 25
29636	Needle 20 G x 100 mm
29637	Needle 20 G x 120 mm
29638	Needle 20 G x 150 mm
29639	Needle 20 G x 180 mm
29640	Needle 21 G x 120 mm
29641	Needle 21 G x 150 mm



## SCHULTZE SALPINGOGRAPH

- 29780 SALPINGOGRAPH Instrument for hystero-salpingography and tubal insufflation, Prof. Gunter K. F. Schultze from Berlin type.
- 29782 WATCH FOR SALPINGOGRAPH
- 29785 HYSTERO SYRINGE - 20 cc - LUER LOCK - spare



MADE IN GERMANY



Instrument can also be read in the dark thanks to the luminescent substance used on the scale

**HYSTEOSALPINGOGRAPH: STANDARD ACCESSORIES**

- Watch for hystero Hystero syringe 20 cc Luer Lock
- Rack-bar 3 interchangeable cones (small-medium-large)



## FC1400 FOETAL MONITOR - 7" TOUCH SCREEN COLOUR TFT LCD

- 29516 FC1400 SINGLE FOETAL MONITOR
- 29517 FC1400 TWIN FOETAL MONITOR

Antepartum foetal monitor to measure Foetal Heart Rate (FHR), degree of material uterine contraction (UA: Uterine Activity), foetal movements (FM)

### Superior data display

- 7" full touch screen colour TFT LCD (800x480)
- 2 display modes: graphic and text modes
- 72 hours of memory capacity

### Extreme data accuracy and access

- high-accuracy and wide detection area
- easy on-screen scrolling function
- enduring watertight probes,



Event marker  
1 MHz probe  
Toco probe

USB function memory storage Wi-Fi convert  
Yellow/green LED alarm for easier recognition of device and patient status

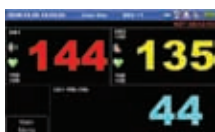

2 display modes

10 smart keys for 16 functions



Compact probes and robust connector



1 MHz to minimize broken FHR waveforms even if the fetus moves

Shelf size 30x29 cm  
Trolley suitable for 29520 and 29516-7

### Printout

- CTG interpretation report
- both standard and A4 size paper usable
- normal fax paper usable

### Other advantages

- Wi-Fi central monitoring up to 16 beds (Option)
- PC compatible
- internal battery lasting 2-hours (Option)
- power adapter 100-240 V, 50-60 Hz
- multilingual internal software: GB, FR, IT, ES, PT, DE, PL, RO, RU, CZ, HU, BG, TR, KR, CN.

Revolving castors

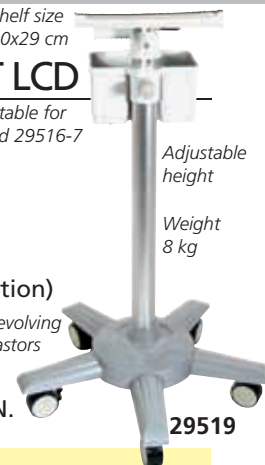

Adjustable height

Weight 8 kg

29519

### TECHNICAL SPECIFICATIONS

Dimensions	296x97.5xh 305.5 mm - Approx. 2.9kg
Display	7" TFT Wide LCD screen (800x480)
Thermal array printer:	print speed: 1, 2, 3 cm/min (real time) paper feeding function
Power	input: 100-240 V, 1.5-0.7 A, 50-60 Hz output: +18 V = 2.8 A
Li-ion battery (option)	4 hours (charging) - 2 hours (discharging)
External link	LAN, Wi-Fi, USB memory
Foetal heart rate	input signal: ultrasound pulsed doppler ultrasound frequency: 1.0 Mhz, 975 KHz ultrasound power: <10 mW/cm <sup>2</sup> FHR detection method: autocorrelation FHR range: 50-210 bpm ±1 bpm (120-160)
Foetal movement measurement	detection source: ultrasound pulsed doppler, event marker
Uterine contraction	input source: external transducer with load cell reference control: one touch switch, auto zeroing measurement range: 0-99
Auto CTG analysis	average baseline FHR number of UC number of acceleration number of deceleration (late, early, variable) early deceleration variable deceleration high episode low episode short term variability signal loss

## COST-EFFECTIVE SINGLE FOETAL MONITOR

- 29520 FOETAL MONITOR GIMA FC 700

Cost-effective single foetal monitor

### Extreme ultrasound doppler sensitivity

- high-accuracy with 1 Mhz frequency
- automatic/manual

### Foetal Movement detection

- auto NST (Non-stress test) function from 10 min. to 1 hour.



Event marker

CE 0123

29520

### Data printout

- CTG analysis printing
- A4 paper with perforation line
- plain thermal fax paper usable
- print speed 1, 2, 3 cm/min

### Easy-to-use

- one-touch operation and easy setup
- alarm function (FHR high-low)
- s/w upgrade via internet

### TECHNICAL SPECIFICATIONS

Dimensions	296x92.5xh 305.5 - approx. 2.9 kg
Display	7 segment LED - 2 channels (FHR, UC)
Thermal printer	print speed: 1, 2, 3 cm/min paper feeding function
Power adaptor	input: 100-240 VAC, 50-60 Hz, 1.2 A output: 18 VDC, 2.5 A
External link	RS-232C
Foetal heart rate	input signal: ultrasound pulsed doppler ultrasound frequency: 1.0 Mhz ultrasound power: <10 mW/cm <sup>2</sup> FHR detection method: auto correlation FHR range: 50-240 bpm ±1 bpm (120-160) reference (zero) control: one touch switch measurement range: 0-99 units
Uterine contraction	detection source: ultrasound pulsed doppler average baseline FHR number of UC number of acceleration number of deceleration (late, early, variable) Tachycardia (moderate, severe) Bradycardia (moderate, severe)
Foetal movement measurement	detection source: ultrasound pulsed doppler
Auto CTG analysis	

## ACCESSORIES FOR FC700 AND FC1400 FOETAL MONITORS

For 29520	For old 29530-31	For 29516-17	ACCESSORIES FOR FOETAL MONITORS
29522	-	-	Paper roll - 215 mm x 23 m
-	29526	29526	Paper roll - 152 mm x 25 m - box of 10
29523	29532	29538, 29540	US doppler probe - spare
29524	-	-	UC/Toco probe up to S/N FF07XXX
29529	-	-	UC/Toco probe since S/N FF08XXX
-	29533	29539, 29541	Toco transducer - spare
29519	29519	29519	Trolley with 2 baskets (adjustable height)
-	29534	-	Battery NI-MH, 12 V, 2,600 mA
-	-	29536	Li-Ion battery
33747	33747	33747	AC adaptor
29525	29525	29525	Belt 5.3x148 cm
29521	-	29521	Event marker - spare

- 29527 WIRELESS CENTRAL STATION FOR FOETAL MONITORS

Central station (PC, monitor, software, wireless, connection kit) to manage up to 16 monitors.



Wireless bluetooth 16 beds central system (distance 10-100 m)

### STANDARD ACCESSORIES (29516, 29517, 29520, 29530, 29531)

1 US doppler probe (2 for 29517 and 29531)	1 ultrasonic gel	1 power cord
2 (29520) or 3 fixing belt (29516-7)	1 stand	1 user manual
1 TOCO probe	2 paper rolls	
1 marker for lying-in women	1 adaptor	



## GIMA FOETAL MONITOR PAPERS FOR DIFFERENT BRANDS

GIMA Code	FOETAL MONITOR manufacturer and model	Standard FHR rate/BPM**	Type	Width mm	Length mm or m'	Sheet	Grid***	Min. order	GIMA Code	FOETAL MONITOR manufacturer and model	Standard FHR rate/BPM**	Type	Width mm	Length mm or m'	Sheet	Grid***	Min. order
<b>BIONET</b>									<b>EDAN</b>								
29528	Fetalcare FC/1400	Int 60/200	roll	152	25	-	green	10	29569	Cadence II	US 30/240	pack	112	90	150	or/red	20
29522	Fetalcare FC/700	US 60/240	roll	215	23	-	green	5	29570	F/6-F/9	Int 60/200	pack	152	90	150	or/red	25
<b>COMEN</b>									<b>HEWLETT PACKARD</b>								
29556	Star 5000/C	Int 60/210	pack	112	100	150	or/red	20	29571	Cadence II	Int 60/200	pack	112	90	150	or/red	20
29557	Star 5000/D	US 30/240	pack	151	100	150	or/red	25	<b>SONICAIID</b>								
<b>COROMETRICS</b>									<b>SHENZHEN CREATIVE</b>								
29561	4305-BAO mod. 116-145-150-151-118	Int 60/200	pack	152	90	150	or/red	25	29556	PC-8000 PRO single	Int 60/210	pack	112	100	150	or/red	20
29562	4305-BAO mod. 116-145-150-151-118	US 30/240	pack	152	90	150	or/red	25	29558	PC-8000 PRO twins	Int 60/210	pack	151	100	150	or/red	25
									29557	PC-8000 PRO twins	US 30/240	pack	151	100	150	or/red	25
<b>SONICAIID</b>									<b>SONICAIID</b>								
29580	Meridian/800 - Team	White paper	pack	143	150	300	white	10									

\*mm (pack) or m (roll)

\*\*International or US standard FHR rate/BPM

\*\*\*or/red: grid could be orange or red colour

## UNIVERSAL TRANSDUCER BELTS FOR FOETAL MONITORS

- 29544 SINGLE PATIENT FOETAL BELTS - 100 pairs (1 pink +1 light blue)

Single patient elastic foetal belts to avoid cross-contamination. Soft and comfortable belts resistant to abrasion, corrosion, light and heat. Great elasticity and insulation. Performance: more than 1,000 stretches. Easy to wash, made of 85% polyester and spandex. Supplied with buttons.

- 29545 REUSABLE FOETAL TRANSDUCER BELTS - box of 10
- Reusable elastic fetal belt resistant to abrasion, corrosion, light and heat. Soft, comfortable and easy to wash and dry. Performance: more than 100,000 stretches. Made of 85% polyester and spandex. Supplied with buttons.

**COMPATIBILITY (29544,29545):** Bionet, EDAN, Philips M1350, Philips FM 20 series, GE, Corometrics, Sonicaid, Huntleigh and most foetal monitors.

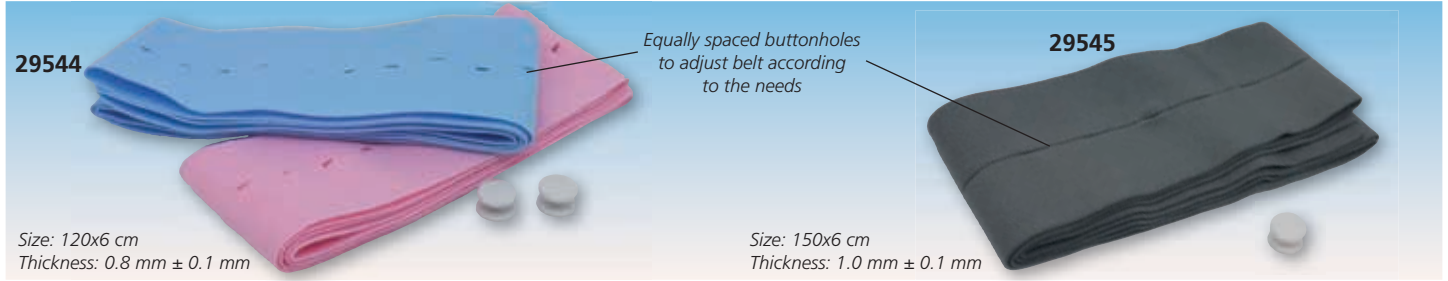

## OBSTETRIC STETHOSCOPES

- 32501 SHORT OBSTETRIC STETHOSCOPE - beech-wood
  - 32502 LONG OBSTETRIC STETHOSCOPE - beech-wood
- These stethoscopes are hand-craft manufactured, made of beech-wood accurately selected and seasoned for at least 3 years. They have a perfect finish with a special transparent varnish. Multilingual box: GB, FR, IT, ES, PT, DE, NL, PL, RO, HU, GR, Arabic.
- 32505 PINARD STETHOSCOPE - aluminium

## LATEX PROBE COVERS



- 29509 LATEX PROBE COVERS - transparent - bag of 1000 pcs - bulk
  - 29513 LATEX PROBE COVERS - transparent - box of 50
  - 29514 LATEX PROBE COVERS - transparent - box of 500
- Probes for ecography and doppler. Length 17 cm, Ø 3.3 cm. Individually packed in single plastic bag, except 29509.



## ENEMA IRRIGATOR

- 28720 ENEMA IRRIGATOR- 2 l capacity

Supplied in cardboard box with 2 cannulas (vaginal, anal), tap with opening lever, tube and carrying bag. Multilingual box: GB, FR, IT, ES.



# GIMA FOETAL POCKET DOPPLERS



• **29503 GIMA FOETAL DOPPLER D2003 with display**  
 Pocket foetal doppler with same specification as code 29502 but with built-in foetal heart rate processing. Foetal heart rate (FHR) is displayed on a large LCD display whilst internal signal process minimises noise artefacts.

• **29505 GIMA FOETAL DOPPLER D2005 with display and waterproof probe**

Same as code 29503 but waterproof probe and sealed electronics. All units are supplied in a nice bag with a tube of coupling gel and user manual in GB, FR, IT, ES, PT, DE, GR.

Battery not included.

• **29512 ON/OFF MEMBRANE SWITCH for codes 29503, 29505**

• **32205 9V ALKALINE BATTERY**



• **29502 GIMA FOETAL DOPPLER G2002**

Small, lightweight, high sensitivity pocket Doppler, with 2 MHz foetal probe, ideal for General Practitioner's or Midwife's use for routine antenatal foetal detection.

Pocket Doppler can be used to detect the beating foetal heart from about 10th week of gestation. It may be used to locate the position of the placenta, thus aiding in the early diagnosis of placenta praevia, to survey blood flow of the umbilical cord and to diagnose multiple pregnancies. Foetal signals are easily located using the lightweight narrow beam transducer while internal signal processing minimizes noise artefacts. Audio foetal heart signals are available to the user via the built-in loudspeaker or option headset, with output level controlled by rotary volume control.

• **29511 ON/OFF MEMBRANE SWITCH for code 29502**

TECHNICAL SPECIFICATION (CODES 29502 - 29503 - 29505)	
Ultrasound	Frequency: 2 MHz continuous wave Transducer: 2 crystal narrow beam Output power: <10mW/mm <sup>2</sup> SATA Audio Response 300Hz -1 KHz autocorrelator (only code 29503 and 29505)
FHR (Fetal heart rate):	50-210 bpm (29503, 29505) 60-210 bpm (29502) resolution ± 1 bpm, accuracy ± 2 bpm
Unit Controls	Keys: 1 Key (for unit on/off) Controls: rotary volume
Indicators:	3 digit FHR LCD display (codes 29503, 29505) FHR pulse icon (codes 29503, 29505), Battery low icon
Power supply	Battery 9 V Alkaline Manganese Expected battery life: 8 hours
Output	Headset: Audio output to optional headset Serial: RS232 interface (codes 29503, 29505)-jack 35 mm
Material:	ABS / Noryl
Size:	150 mm by 75 mm Weight: 295 g (with transducer)
Classification:	Class I Type B - IEC 60601-1 CE 0120

# SONOTRAX DOPPLERS



**SUPPORT 2MHz, 3MHz, 4MHz, 8 MHz WATERPROOF PROBES**

**29493**

**TECHNICAL SPECIFICATIONS**

Size: 32x85x138 mm  
 Weight: 290 g (including battery)  
 Heart rate range: 50-210 bpm  
 Resolution: 1 bpm  
 Accuracy: ± 3 bpm  
 LCD display: 45x25 mm (only code 29491-93)  
 Auto average and manual mode  
 Recording length: 480 s / 240 s  
 Auto power-off to save power  
 Manual: GB, IT - on request: DE, ES, FR, PT.

GIMA code	DOPPLERS AND INTERCHANGEABLE PROBES - LATEX FREE
29490	SONOTRAX LITE DOPPLER - without probe - with bag
29491	SONOTRAX BASIC DOPPLER - with display - without probe - with carrying bag
29493	SONOTRAX PRO II DOPPLER with backlit display built-in audio recorder and rechargeable batteries with battery charger - without probe - with carrying bag
29496	2MHz waterproof probe - gynaecology
29497	3MHz waterproof probe - gynaecology
29498	4MHz waterproof probe - vascular
29499	8MHz waterproof probe - vascular
29500	Rechargeable Ni-Mh battery for 29493 - spare

# GIMASONIC COLOUR DOPPLER

**COLOUR SCREEN POCKET DOPPLER**

- built-in speaker  
 - TFT-LCD, real-time display of FHR  
 - three working modes: real-time FHR, average FHR and manual calculation  
 - display of FHR, bar graph and heartbeat waveform, red alarm for abnormal FHR  
 - low power consumption, continuously work for more than 8 hours with two "AA" batteries  
 - indication for probe-off and low battery  
 - range of probes for foetal or vascular use: 2, 3, 4, 8 MHz probe  
 Suitable for use after the 12<sup>th</sup> week of pregnancy  
 Multilingual box and manual: **29480**  
 GB, FR, IT, ES, PT, DE.



TECHNICAL SPECIFICATIONS	
Ultrasound working frequency:	2 MHz ± 10%
Fetal heart rate:	range: 50-240 bpm resolution: 1 bpm accuracy: ± 2 bpm
Alarm:	high limit: 160 bpm low limit: 120 bpm
Ultrasound intensity:	< 5 mm/cm <sup>2</sup>
Auto power off after	1 minute no signal
Size - weight:	135x92x29 mm - 245 g
Power supply:	2 AA Batteries LR6 - 1.5 V DC

GIMA code	GIMASONIC COLOUR SCREEN DOPPLER
29480	GIMASONIC Colour screen doppler - without probe
29481	2 MHz waterproof probe - gynaecology
29482	3 MHz waterproof probe - gynaecology
29484	8 MHz waterproof probe - vascular

## S/S GINAECOLOGY INSTRUMENTS AND KITS



26817

• **26817 HEGAR DILATORS SET - chrome plated**  
Include 14 dilators Ø 4-17 mm

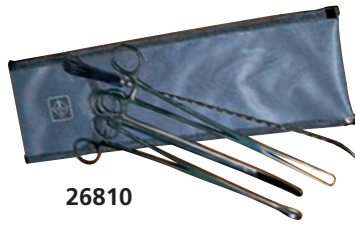

26810

• **26810 GYNAECOLOGY KIT**  
Includes 4 instruments in a nylon bag. See page 45.

- 26801 FOERSTER FORCEPS 25 cm
- 26802 SCHROEDER FORCEPS 25 cm
- 26806 SCHUMACHER BIOPSY FORCEPS 24 cm
- 26808 SCHUBERT BIOPSY FORCEPS - 21 cm
- 26809 KOGAN ENDOSPECULUM - 24 cm

**OTHER GYNAECOLOGY INSTRUMENTS**  
See page 45

## S/S DELIVERY SURGICAL SET



26966

• **26966 MINOR DELIVERY SET - 25 pcs**  
Kidney Dish 20 cm (8") - medium  
Kidney Dish 25 cm (10") - large  
Gallipot 150 ml - 6 oz - medium  
Brown Sadler episiotomy scissors - 14 cm  
Kocher artery forceps straight - 16 cm  
Kocher artery forceps straight - 18 cm  
Kocher artery forceps curved - 16 cm  
English TOE dissecting forceps plain - 14 cm  
English TOE dissecting forceps plain - 18 cm  
Dissecting forceps toothed 1x2 - 14 cm  
2 operating scissors sharp/blunt - straight - 15 cm  
2 operating scissors sharp/blunt - curved - 15 cm  
2 rampley sponge holding forceps - str. - 24 cm  
Museux Vulsellum forceps 8 mm - str. 24 cm  
3 Cusco vaginal specula - small, medium, large  
3 Sims vaginal specula - small, medium, large  
Umbilical scissors USA Patent - 10.5 cm  
Instrument tray with lid 45x30x6.2 cm

## UMBILICAL CLAMP



MADE IN EUROPE

29942

Extra safe clamp avoid accidental re-opening. Can be re-opened only by cutting back side

CE 0373

• **29942 X-SAFE UMBILICAL CORD CLAMP - sterile - box of 500**  
Disposable umbilical cord clamp to allow a proper clamping of all umbilical cords and prevent their outcoming from the closing comb. Individually packed in coupled cellophane (nylon/polyethylene) and medical paper to ensure safe hygienic conditions to user. Sterilized by ethylene oxide.

## GYNAECOLOGY SET - STERILE

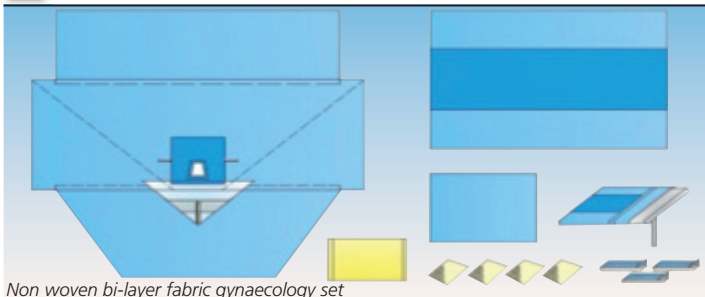

Non woven bi-layer fabric gynaecology set

• **23641 GYNAECOLOGY SET - sterile - box of 8**  
1 table cover 150x200 cm with central absorbent band  
1 Mayo stand cover 80x145 cm  
1 gynaecology drape for lithotomy position 290x240 cm with adhesive hole, built-in leggings, bag for liquid collection with filter and drain valve  
1 drape 75x90 cm  
1 incision film 35x50 cm  
3 adhesive strips 10x50 cm  
4 towels 35x40 cm

• **23644 SET FOR CESAREAN SECTION - sterile - box of 8**  
1 table cover 150x200 cm with central absorbent band  
1 Mayo stand cover 80x145 cm  
1 drape for caesarean section  
260x200x310 cm with incision film and bag for liquid collection  
1 drape "baby blanket" 75x90 cm  
See picture at page 40

## MEMBRANE PERFORATOR



29945

• **29945 AMNIOTIC MEMBRANE PERFORATOR - sterile - box of 600**  
Disposable amniotic perforator. This system is thought to be completely safe to avoid lesions to the foetus. Supplied in single sterile envelope.

CE 0373

## I.D. BRACELET

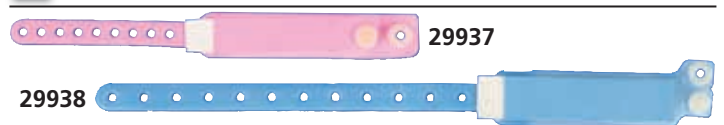

29937

29938

GIMA code	I.D. BRACELET	Colour	Minimum order
29936	Newborn	light blue	box of 100 pcs.
29937	Newborn	pink	box of 100 pcs.
29938	Mother	light blue	box of 100 pcs.
29939	Mother	pink	box of 100 pcs.

## CUPS FOR HYSTEROGRAPHY AND SIFT SCREW SYRINGE

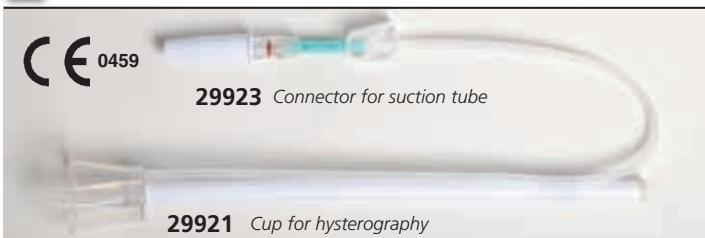

CE 0459

29923 Connector for suction tube

29921 Cup for hysteroigraphy

• **29920 CUPS FOR HYSTEROGRAPHY - 25 mm - sterile**  
• **29921 CUPS FOR HYSTEROGRAPHY - 30 mm - sterile**  
• **29922 CUPS FOR HYSTEROGRAPHY - 35 mm - sterile**  
• **29923 CUPS CONNECTOR - sterile**

Rigid, transparent tapered cup with a central conical cannula. Equipped with a 25 cm long flexible, pliable manipulator joined to the cup and two tubes equipped with clamps. One of these provides the vacuum, while the other injects the radiopaque medium. Perfect adhesion to the cervix by self-centering is ensured by the tapered shape of the cup and the progressive application of a vacuum to the cup. The suction cup/cannula unit is radiotransparent and allows the proximal area of the endocervix to be controlled. The radiologist is able to manipulate at a distance from the radioactive field while at the same time comfortably immobilizing the uterus. Latex free.

# IUD - INTRAUTERINE CONTRACEPTIVE DEVICE

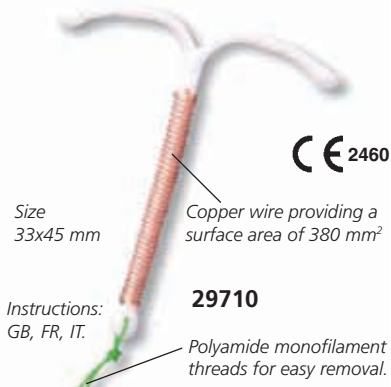

**• 29710 INTRAUTERINE DEVICE TCU380 PLUS - sterile**  
Sterile disposable medical device Class III for intrauterine contraception in women of child bearing age. Can be left inserted for a maximum of 5 years. Packed in a pouch with an insertion tube equipped with a movable flange to aid in gauging the right depth of insertion and a rod. Complies with ISO-7349.



**• 29712 GYNEAS IUD KIT - sterile**  
A complete disposable kit for IUD insertion including: 1 intrauterine device (IUD), 1 speculum medium size, 1 hystrometer, 1 pair of Pozzi tenaculum forceps, 1 Evolution forceps, 1 pair of thread-cutting scissors, 1 practitioner and 1 patient brochure.

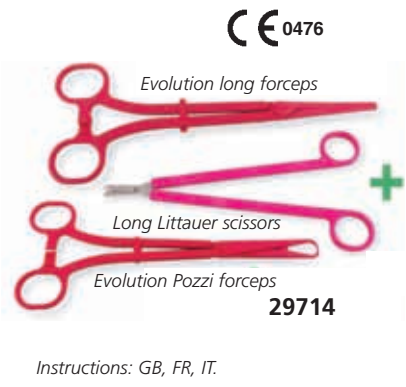

**• 29714 IUD INSERTION AND REMOVAL KIT - sterile**  
Disposable kit for IUD insertion and removal including: 1 Evolution Pozzi forceps, 1 long Littauer scissors, 1 Evolution long forceps.

## GYNAECOLOGY FORCEPS AND SCISSORS

**• 29717 CHERON FORCEPS 25 cm - box of 25**  
Suitable for:  
- cervix cleaning/disinfection before any intervention (ex. IUD insertion) used with a gauze or a piece of cotton and disinfectant solution  
- IUD removal

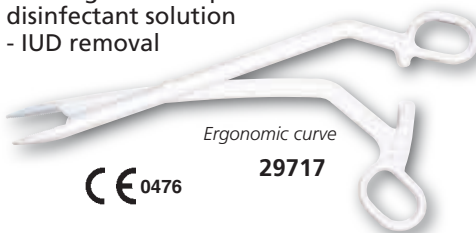

**• 29719 EVOLUTION LONG FORCEPS 25 cm - box of 25**  
Same applications as Cheron forceps, but with longer and thinner jaws.

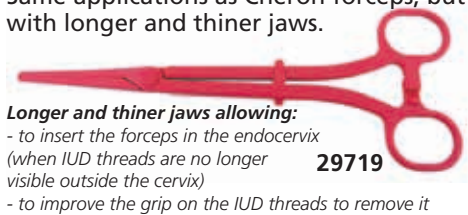

**• 29718 POZZI FORCEPS 25 cm - box of 25**  
Ergonomic, strong and thin single-use forceps suitable for grasping of the cervix, cervical cerclage, biopsies, conisations, IUD insertion (align cervix and womb with vagina axis).

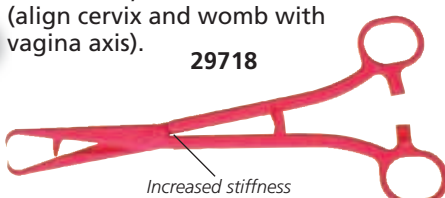

**• 29720 LONG LITTAUER SCISSORS 22 cm - box of 25**  
Suitable for cutting the IUD threads after the insertion.



## BIOPSY FORCEPS

**• 29724 GYN&PUSH CERVICAL BIOPSY FORCEPS 21.5 cm - box of 25**  
Effective cervical biopsy forceps for a successfully biopsy, quickly achieved with a high quality sample. Complete comfort and safety for both doctor and patient. Disposable sterile medical device, Class II a. Latex free and phtalates free. Shelf life: 5 years.

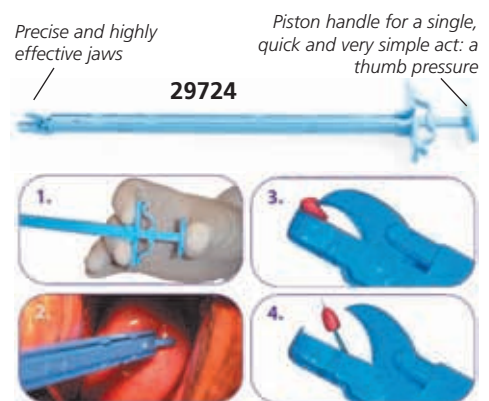

## FLEXIBLE HYSTEROMETERS

**SINGLE USE, STERILE, FLEXIBLE HYSTEROMETERS**  
Hysterometers with soft distal part on a rigid handle for IUD\* (29925, 29926). Hysterometer with progressive dilation distal part from CH 10 to CH 14 on 25 mm, suitable for IUS\*\* (29927).

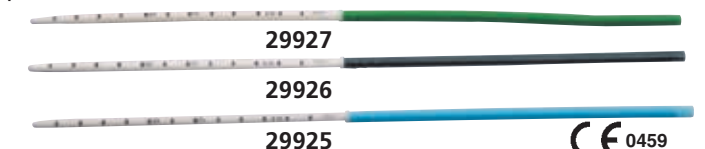

GIMA code	HYSTEROMETERS SINGLE USE - STERILE - LATEX FREE	Ø	Minimum order
29925	Hysterometer CH 10 - 30 cm	3.3 mm	box of 25
29926	Hysterometer CH 12 - 30 cm	4.3 mm	box of 25
29927	Hysterometer CH 14 - 30 cm	4.67 mm	box of 25

\*IUD: Intra Uterine Device \*\*IUS: Intra Uterine System

## EVOLUTION HYSTEROMETER

**• 29929 EVOLUTION DOUBLE HYSTEROMETER 30 cm - box of 25**  
The most versatile, economical and eco-friendly single-use hysterometer. Estimating the uterine depth, checking cervical canal permeability and womb orientation. Sterile, disposable medical device, class I. Latex free, PVC free. Shelf life: 5 years.

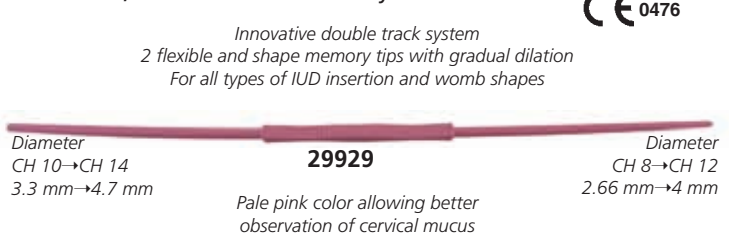

## DISPOSABLE ANO/PROCTO/SIGMOIDOSCOPES

### 25953 F.O. ILLUMINATION HEAD

Perfectly fits and illuminates GIMA, HEINE, WELCH ALLYN, GPS disposable anoscopes, rectoscopes, proctoscopes. It can be connected to a light source by a F.O. cable or to a LED illumination system. See page 239.

### 25947 DISPOSABLE ANOSCOPE - sterile - box of 60

Length 10 cm, with stylet diameter 15 mm, suitable for treatment of haemorrhoids. Atoxic, phthalate and latex free.

The disposable anoscope is sold in a paper and polyethylene envelope sterilized in ethylene oxide. Made of transparent, atoxic, dust resistant plastic. Latex and phthalate free.

Disposable proctoscope see at page 218.

### HEINE UNISPEC DISPOSABLE TUBES

#### 25944 HEINE UNISPEC DISPOSABLE ANOSCOPE 85x20 mm

E-003.19.925 - box of 25

#### 25945 HEINE UNISPEC DISPOSABLE PROCTOSCOPE 130x20 mm

E-003.19.825 - box of 25

#### 25946 HEINE UNISPEC DISPOSABLE SIGMOIDOSCOPE 250x20 mm

E-003.18.825 box of 25

2 lens (1.5 X and 2 X) included

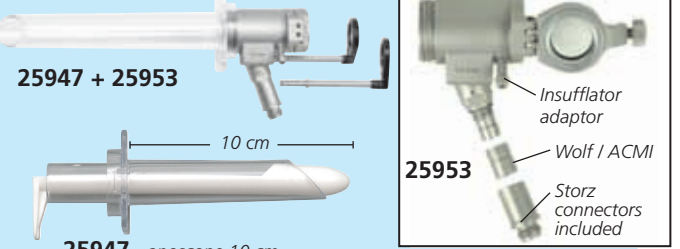

25947 + 25953

10 cm

25947 - anoscope 10 cm

25953  
Insufflator adaptor  
Wolf / ACMI  
Storz connectors included

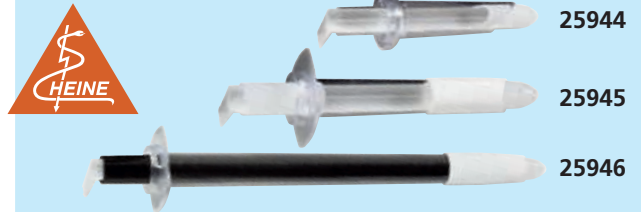

25944

25945

25946

## ILLUMINATION OF F.O. ANO/PROCTO/SIGMOIDOSCOPES



30799

### 30799 ILLUMINATED HANDLE 6.0 VOLT

Independent light source for F.O. instruments. Direct connection to all F.O. instruments.

### 30800 HALOGEN BULB - spare for 30799

### 30803 GIMALED LIGHT SOURCE - see page 239

To connect anoscopes/rectoscopes/sigmoidoscope to GimaLed light source (30803) you need: F.O. cable (30818-30826), adaptor (30830) to connect cable to light source, 2 adaptors (30840, 30844) to connect sigmoidoscope to F.O. cable.

## F.O. ANOSCOPES, PROCTOSCOPES



F.O. ANOSCOPES

29405

F.O. PROCTOSCOPE

GIMA code	F.O. ANOSCOPES - PROCTOSCOPES	ADAPTOR included
29400	F.O. Anoscope Ø15x70 mm - with obturator	Wolf/Acmi/Storz
29401	F.O. Anoscope Ø20x70 mm - with obturator	Wolf/Acmi/Storz
29402	F.O. Anoscope Ø25x70 mm - with obturator	Wolf/Acmi/Storz
29403	Set of 3 F.O. anoscopes in a case	Wolf/Acmi/Storz
29405	F.O. Proctoscope Ø 20x130 mm - with obturator with 2.0X	Wolf/Acmi/Storz
30840	ENDO STORZ ADAPTOR - to connect with Gima F.O. cable	

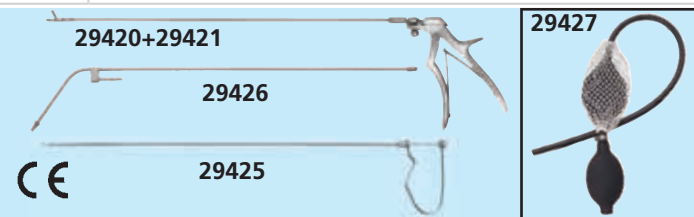

29420+29421

29426

29425

29427

## F.O. SIGMOIDOSCOPES

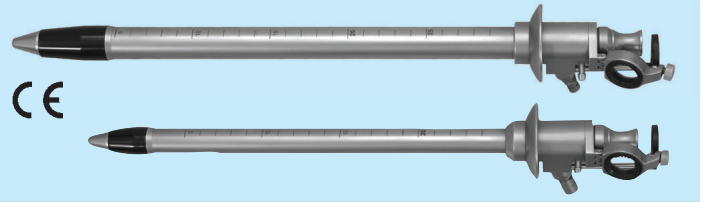

GIMA code	F.O. SIGMOIDOSCOPES WITH 1.5X MAGNIFICATION SWIVEL LENS	ADAPTOR included
29410	F.O. Sigmoidoscope - 12x200 mm	Wolf/Acmi/Storz
29411	F.O. Sigmoidoscope - 16x250 mm	Wolf/Acmi/Storz
29412	F.O. Sigmoidoscope - 21x200 mm	Wolf/Acmi/Storz
29413	F.O. Sigmoidoscope - 21x250 mm	Wolf/Acmi/Storz
29414	F.O. Sigmoidoscope - 21x300 mm	Wolf/Acmi/Storz
30840	ENDO STORZ ADAPTOR - to connect with Gima F.O. cable	

GIMA code	S/S ACCESSORIES FOR F.O. ANOSCOPES, PROCTOSCOPES, SIGMOIDOSCOPES
29420	Handle for Biopsy forceps
29421	Biopsy forceps 3.5x8 mm Cup Jaws - 420 mm
29422	Biopsy forceps 4 mm - Cutting Jaws - 420 mm
29425	Sponge Holding forceps - 400 mm
29426	Suction Tube - 400 mm
29427	Twin Bellow Insufflator

## AMNIOSCOPE: TUBES AND SET

### 29970 AMNIOSCOPE SET includes 29971/2/3/5 and 30840

Set of three amnioscope tubes with shutter 200 mm length, 12, 16 and 20 mm diameter and a clamp for fibre optic light. All tubes are graduated in centimetres, have a rounded end and are sterilizable by any method. Supplied in a cordura bag (27129). To light amnioscope set you can use GimaLed light source (code 30803), adaptor (code 30830), F.O. cable (code 30818).

Single tube needs adapter for clamp (code 30840) and clamp (29975).

#### 29971 AMNIOSCOPE TUBE 12x24x200 mm

#### 29972 AMNIOSCOPE TUBE 16x24x200 mm

#### 29973 AMNIOSCOPE TUBE 20x24x200 mm

#### 29975 ANGLED CLAMP FOR LIGHT CONNECTION

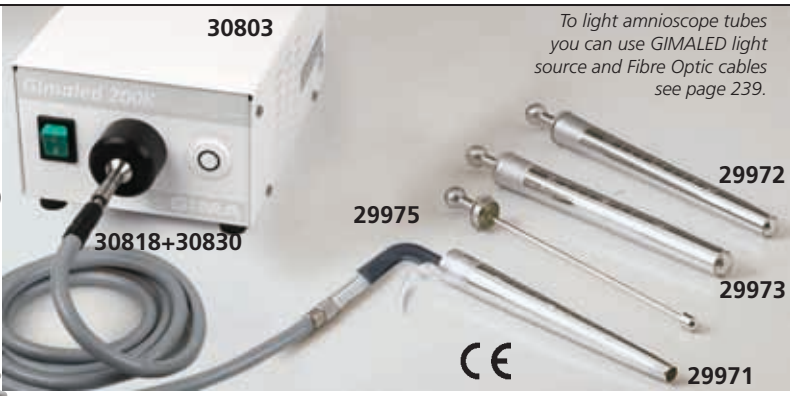
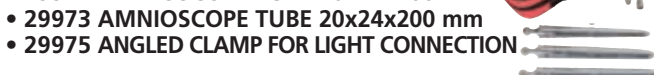

30803

30818+30830

29975

29972

29973

29971

CE

To light amnioscope tubes you can use GIMALED light source and Fibre Optic cables see page 239.

## DISPOSABLE STERILE VAGINAL SPECULUM



**SIDE SCREW SPECULUM - with gradual adjustment - sterile**  
Disposable sterile speculum with gradual screw-action adjustment. Available in 3 sizes.  
Made in Asia.

GIMA code	SIDE SCREW VAGINAL SPECULUM - STERILE	Minimum order
29983	SIDE SCREW speculum - small Ø 20 mm	box of 100
29984	SIDE SCREW speculum - medium Ø 28 mm	box of 100
29985	SIDE SCREW speculum - large Ø 33 mm	box of 100
29986	SIDE SCREW speculum - mixed* sizes	box of 100

\*mixed box includes 20 small, 70 medium, 10 large vaginal speculum



**CENTRAL PIN, MIDDLE SCREW, TACHE SPECULUM**  
Three different models of disposable sterile speculum.  
Sold in mixed box containing 3 sizes: small, medium, large.  
Made in Asia.

GIMA code	CENTRAL PIN / MIDDLE SCREW / TACHE STERILE	Minimum order
29991	CENTRAL PIN Speculum - mixed* sizes	box of 100
29995	MIDDLE SCREW Speculum - mixed* sizes	box of 100
29987	TACHE Speculum - mixed* sizes	box of 100

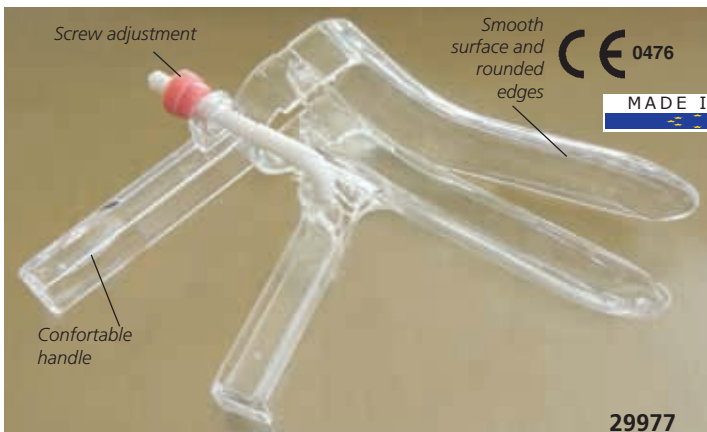

**CUSCO SPECULUM - with gradual adjustment - sterile**  
Disposable speculum with gradual screw-action adjustment. It is manufactured with the best non-toxic transparent material, comes in a single transparent vacuum pack and is sterilized with ethylene oxide. Sterilization is guaranteed by the special quality control label on each pack. Available 3 sizes distinguishable through screw colour.

GIMA code	CUSCO VAGINAL SPECULUM - STERILE	Minimum order
29976	CUSCO Speculum - small 85 x 20 mm	box of 120
29977	CUSCO Speculum - medium 90 x 28 mm	box of 120
29978	CUSCO Speculum - large 100 x 36 mm	box of 108

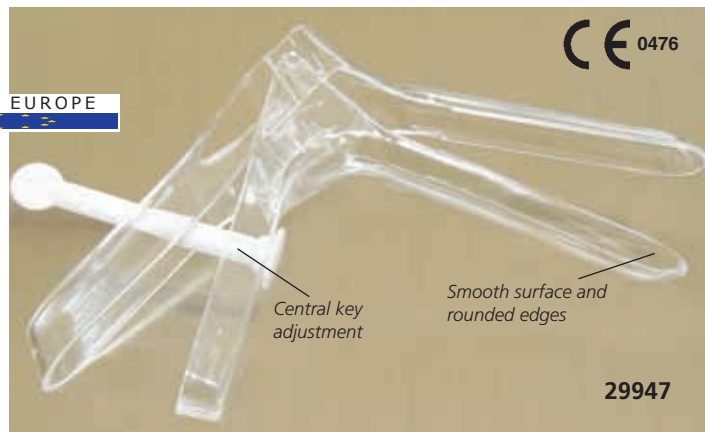

**PERNO SPECULUM - with central key adjustment**  
For dilation of the vaginal canal to expose the uterus neck. It allows the adjustment of the vaginal opening by positioning the blades and locking the central key. The smooth surface and rounded edges aid a comfortable introduction. The central key can be bent down for an easier introduction of cumbersome instruments. Available 3 sizes distinguishable through key colour.

GIMA code	PERNO VAGINAL SPECULUM - STERILE	Minimum order
29946	PERNO Speculum - small Ø 20 mm	box of 120
29947	PERNO Speculum - medium Ø 26 mm	box of 120
29948	PERNO Speculum - large Ø 30 mm	box of 120

## STAINLESS STEEL VAGINAL SPECULUM - CUSCO AND COLLIN



GIMA code	STAINLESS STEEL SPECULUM
29770	Cusco stainless steel speculum - small 75x32 mm
29771	Cusco stainless steel speculum - medium 85x35 mm
29772	Cusco stainless steel speculum - large 100x37 mm
29773	Cusco stainless steel speculum - virgin 75x17 mm
29763	HF Cusco stainless steel speculum - medium with insulation for HF applications and suction connector
29768	Collin stainless steel speculum - medium 100x35 mm

## STERILE PAP TEST KITS

Instructions:  
GB, IT, PT

CE 0373



29702

READY TO USE  
PAP TEST KIT

• **29702 PAP TEST KIT - sterile - box of 100 pcs.**  
Pap-Test is a painless examination to detect the presence of any anomalous cells on the cervix. It allows an early diagnosis of uterus neck cancer. The functional configuration of the kit allows a ready to go operation. The kit includes: two latex gloves, one perno speculum (medium size), one brush, one Ayre spatula (wooden), two slides and one box for them. Individually packed in sterile pouch.

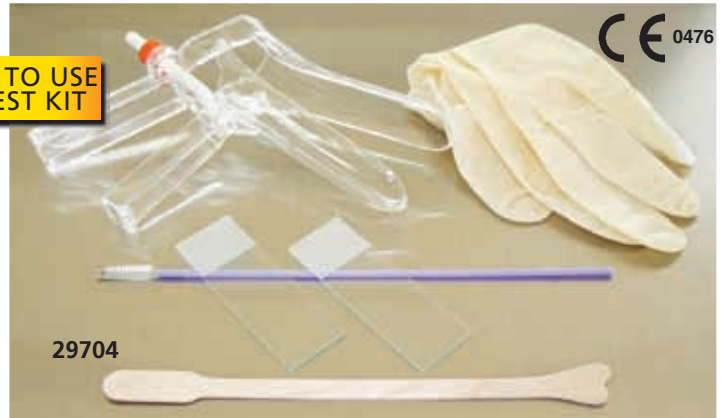

29704

CE 0476

• **29704 PAP TEST KIT - sterile - box of 50 pcs**  
The kit includes: one pair latex glove, one side-screw speculum (medium size), one GIMA brush ball, one Ayre spatula A size (wooden), two slides. Individually packed in sterile pouch.

• **29703 PAP TEST KIT - sterile - box of 100 pcs**  
Same as 29702 but without speculum. Instructions: GB, FR, IT.

29703

## LUBRIGIMA: LUBRICANT GEL

• **29960 LUBRIGIMA - 250 ml**  
Facilitates instruments insertion during gyn. examinations. Its special composition and high transparency do not alter the visual image when optical instruments are used. It does not contain spermicides and does not grease or stain. It has acid Ph and good electrical conductivity. Water soluble. Well absorbed by the skin, does not irritate the mucosa. LATEX FREE.



29960

MADE IN ITALY

## KLY LUBRICATING GEL

• **29957 KLY LUBRICATING GEL**  
sachet 5 g - box of 100  
• **29959 KLY LUBRICATING GEL**  
tube 82 g - 1 tube  
• **29958 KLY LUBRICATING GEL**  
tube 42 g - sterile and paraben-free - 1 tube  
Hypoallergenic lubricating gel, does not irritate skin, dissolves in water and is easily cleaned. It does not contain oil or oily substances. It has no toxic effects or odour. It is used in endoscopy, gastroscopy, colonoscopy and rectoscopy.



Each 100 g



29959

Multilingual box and manual (29958-9 only):  
GB, FR, IT, ES, DE, PT, GR, RU, TR, Arabic

## LUBRICATING GEL WITH CHLOREXIDINE

• **29961 FARMAGEL® C LUBRICATING GEL WITH CHLOREXIDINE - single use squeeze bulb 12.5 g - sterile - box of 25**  
Farmagel® C is a sterile water-soluble, grease-free, transparent lubricating gel. Suitable for endoscopic procedures which require lubricating action. It reduces friction between probe and mucosa facilitating the entry of diagnostic or therapeutic devices into the body. It does not irritate and is easily removable from skin and clothing. Ingredients: chlorhexidine (0.05%), hydroxyethyl cellulose, glycerin, purified water, hydrochloric acid. Class IIa medical device.

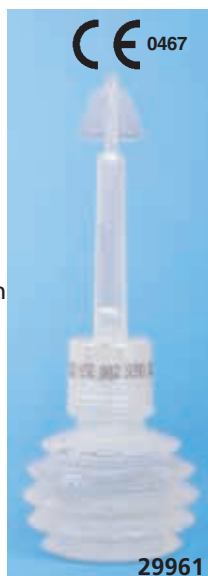

29961

CE 0467

MADE IN ITALY

## PROCTOSCOPE

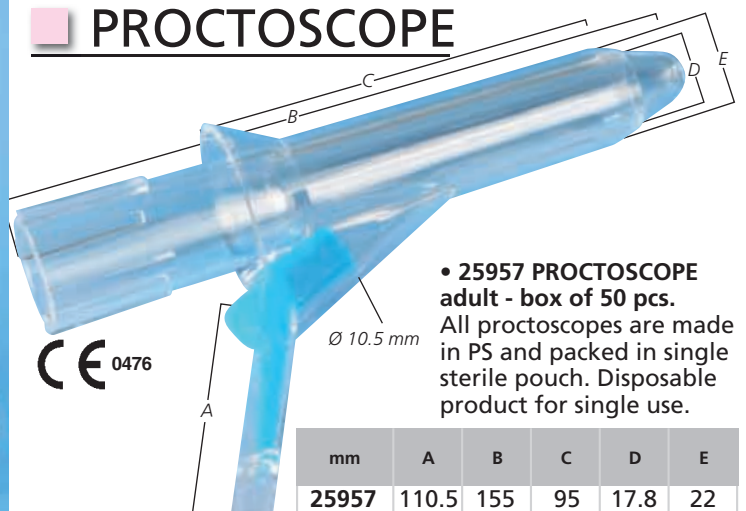

• **25957 PROCTOSCOPE adult - box of 50 pcs.**  
All proctoscopes are made in PS and packed in single sterile pouch. Disposable product for single use.

mm	A	B	C	D	E
25957	110.5	155	95	17.8	22

## AYRE SPATULA - BIRCH WOOD



GIMA code	AYRE SPATULA - WOOD	Length	Minimum order
29743	Ayre Spatula A 5 boxes of 100 pcs = 500 pcs	18 cm	500 pcs.
29745	Sterile Ayre Spatula A Individually packed in sterile pouch, in box of 100	18 cm	100 pcs.

## AYRE SPATULA - PLASTIC

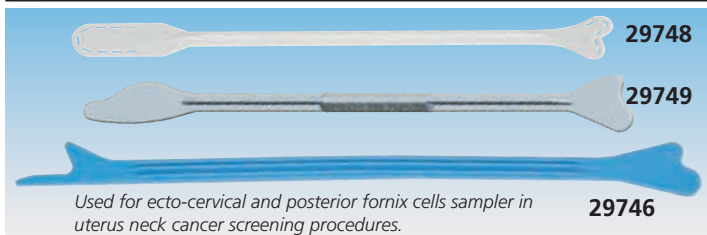

GIMA code	AYRE SPATULA - PLASTIC	Material	Length	Minimum order
29746	Ayre Spatula Packed in plastic bags of 25 pcs., in carton of 400 pcs.	PP	18 cm	400 pcs.
29748	Sterile Ayre Spatula A Individually packed in sterile pouch, in box of 100	PP	18 cm	100 pcs.
29749	Sterile Ayre Spatula B Individually packed in sterile pouch, in box of 100	PP	18.8 cm	100 pcs.

## GIMA BRUSH



- 29739 GIMA BRUSH - conical - bag of 25 pcs.
  - 29740 GIMA BRUSH - conical - box of 400 pcs.
- These single-use endocervical brushes are an efficient method of collecting vulval, endocervical and nasal surface samples for cytological/microbiological examinations. Non sterile. Packed in plastic bags of 25 units, in carton of 400 units.
- 29742 GIMA BRUSH - conical - STERILE - box of 500 pcs
- As code 29740, individually packed in sterile plastic bag. Multilingual manual: GB, FR, IT, ES, PT, DE, FI, GR, HR.

## GIMA BRUSH - STERILE

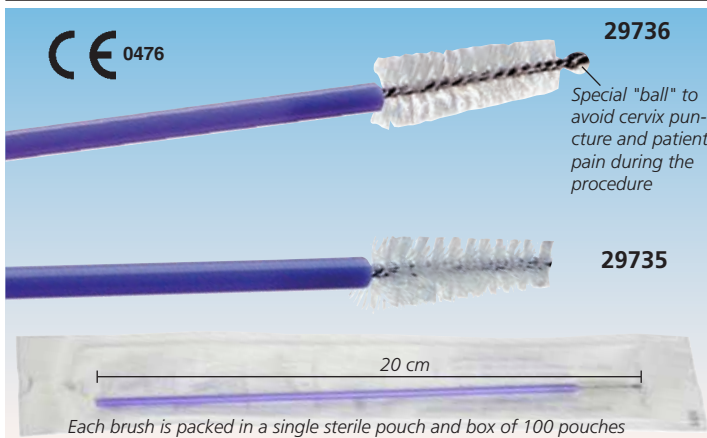

- 29735 GIMA BRUSH B - sterile - box of 100 pcs.
  - 29736 GIMA BRUSH BALL - sterile - box of 100 pcs.
- Each brush is packed in a single sterile pouch and box of 100 pouches.

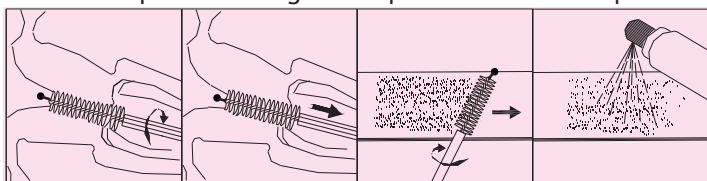

## COTTON SWABS

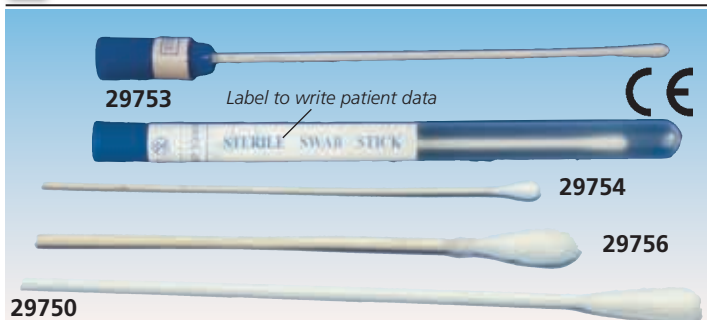

GIMA code	COTTON SWABS	Shaft Material	Cotton Ø	Shaft length	Minimum order
29750	Cotton Swab Packed in plastic bags of 25 pcs., in carton of 400 pcs.	Plastic	1 cm	18 cm	400 pcs.
29753	Sterile Cotton Swab Packed in box of 100 pcs.	Plastic	15 cm	18 cm	100 pcs.
29754	Cotton Swab Packed in plastic bags of 100 pcs., in carton of 1000 pcs.	Wood	15 cm	18.8 cm	1,000 pcs.
29756	Cotton Swab Packed in plastic bags of 50 pcs., in carton of 500 pcs.	Wood	15 cm		500 pcs.

## WALLACH PAPETTE, GIMA COLLECTOR

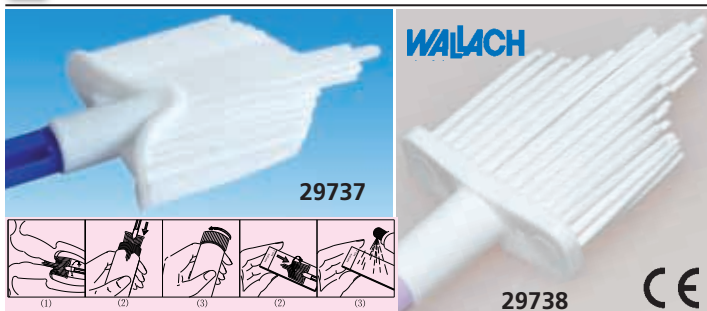

With Wallach papette all it takes is a simple rotating motion to collect a total sampling endocervical and ectocervical cells, including the transformation area, with less trauma.

GIMA code	PAPETTES	Material	Shaft length	Minimum order
29738	Wallach papette Packed in bag of 100 pcs with multilingual manual (GB, FR, IT, ES, PT, GR)	Plastic	16 cm	100 pcs.
29737	Sterile GIMA collector Packed in a single sterile pouch in box of 100 pouches	Plastic	19.5 cm	100 pcs.



## "KARMAN" AND "BERKELEY" INTRAUTERINE SUCTION CURETTES

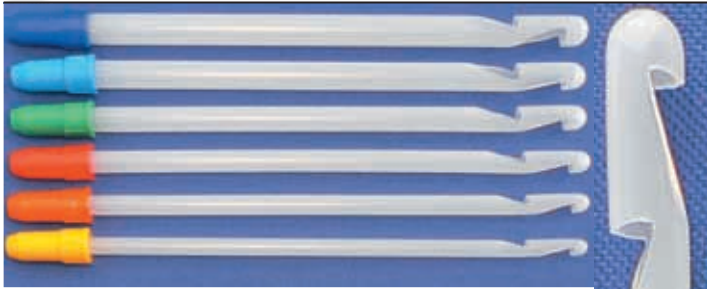

Length 24 cm with connector, 20.5 cm without



Length 20 cm with connector, 17 cm without

GIMA code	"KARMAN" STYLE CURETTES FLEXIBLE - SINGLE USE - STERILE	Minimum order
29858	Karman Curette N° 4 - 4 mm x 24 cm	box of 20
29859	Karman Curette N° 5 - 5 mm x 24 cm	box of 20
29860	Karman Curette N° 6 - 6 mm x 24 cm	box of 20
29861	Karman Curette N° 7 - 7 mm x 24 cm	box of 20
29862	Karman Curette N° 8 - 8 mm x 24 cm	box of 20
29863	Karman Curette N° 9 - 9 mm x 24 cm	box of 20
29864	Karman Curette N° 10 - 10 mm x 24 cm	box of 20
29865	Karman Curette N° 11 - 11 mm x 24 cm	box of 20
29866	Karman Curette N° 12 - 12 mm x 24 cm	box of 20

MADE IN ITALY



GIMA code	"BERKELEY" STYLE CURETTES CURVED - RIGID - SINGLE USE - STERILE	Minimum order
29870	Berkeley Curette N° 7 - Ø 7 mm x 20 cm	box of 20
29871	Berkeley Curette N° 8 - Ø 8 mm x 20 cm	box of 20
29872	Berkeley Curette N° 9 - Ø 9 mm x 20 cm	box of 20
29873	Berkeley Curette N° 10 - Ø 10 mm x 20 cm	box of 20
29874	Berkeley Curette N° 11 - Ø 11 mm x 20 cm	box of 20
29875	Berkeley Curette N° 12 - Ø 12 mm x 20 cm	box of 20

## CANNULAS FOR ENDOMETRIAL SAMPLING

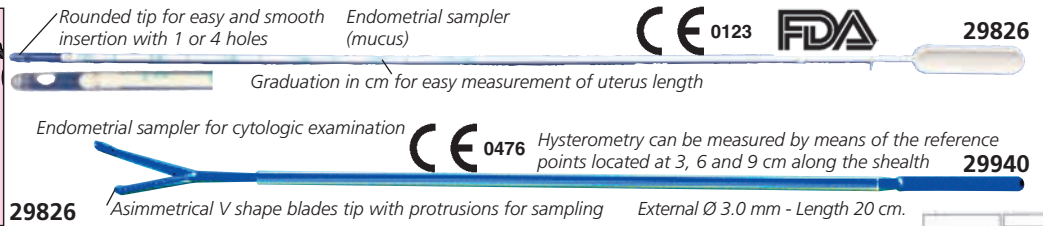
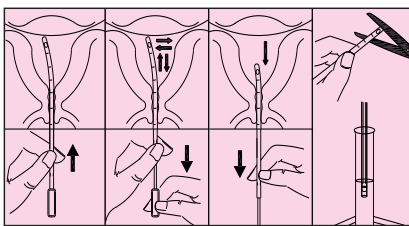

• **29826 PIPELLA 1 hole - disposable, sterile - box of 100**  
 • **29827 PIPELLA 4 holes - disposable, sterile - box of 100**  
 For endometrial cytologic sampling. It allows a painless and easy routine screening of the endometrium avoiding dilation and traction of the uterus neck.  
 Hole: Ø 2.0-2.5 mm  
 External diameter: 3.1 mm  
 Length of cannula: 23.5 cm  
 Length of handle: 26.5 cm

• **29940 ENDOGYN - disposable, sterile - box of 25**  
 For cytologic endometrial sampling. It allows a painless and easy routine screening of the endometrium avoiding dilation and traction of the uterus neck. An outer sheath covers a mandrel with asymmetrical "V" shaped blades on the top. Each arm features fine toothings and thin cutting edges which are able to remove and keep more endometrial tissue. The head of one of the two arms features a hemispherical head which, when it goes back inside the sheath, allows for previously removed tissue to be aspirated.

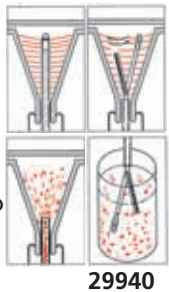

## MICROSCOPE SLIDES AND BOX



Multilingual box:  
 GB, FR, IT, ES, PT, GR

**MICROSCOPE SLIDES**  
 Size 76x26 mm, 1.0-1.2 mm thick 45° corners

GIMA code	MICROSCOPE SLIDES box of 200 pcs. (4 boxes of 50 pcs.)
29774	Plain side, ground edges
29775	Single end frosted, sandblasted band, ground edges
29777	Twin frosted in both ends, ground edges, sandblasted band
BOX FOR SLIDES	
29776	Box for slides - box of 20 pcs



29777  
 Twin frosted in both ends, ground edges, sandblasted band



29775  
 Single end frosted, sandblasted band, ground edges



29774  
 Plain side, ground edges



**BOX FOR SLIDES**  
 Plastic, transparent box for storage of up to three slides.

## CITOLOGY FIXATION

• **29778 GIMAFIX SPRAY FOR CITOLOGY FIXATION - 250ml - box of 12**  
 Fixer for cytology.  
 Composition: isopropanole, poly-ethylenglycole.  
 It does not contain propellants deleterious for the ozone.



29778

MADE IN ITALY

# PREGNANCY TESTS: MIDSTREAM, STRIP AND CASSETTE



**CUSTOMIZED PREGNANCY SELF TESTS**  
minimum 5,000 pcs.

CE 0197  
Extra early detection 3 days before you miss your period

**SHELF LIFE 36 MONTHS**

Large wipe allows a better absorption of the urine sample reducing the risk of false results

GIMA offers a complete line of pregnancy tests, both for OTC market (self test) and for professional use. All products are packed in cardboard boxes with multilingual user manual (GB, IT, ES, FR, GR, PT, DE\*, PL\*). \*Manual only

- Main features:
- each test is individually packed in sealed aluminium pouch
  - very quick, in 3 minutes
  - early detection: it can be used since the first day you miss your period (three days before for 29103)
  - accuracy: 99.9% (29090-2), 99.0% (29097-8, 29103)
  - sensitivity: 20 mIU/ml (29090, 29091, 29092, 29097, 29098) 10 mIU/ml (29103)
  - clinically tested

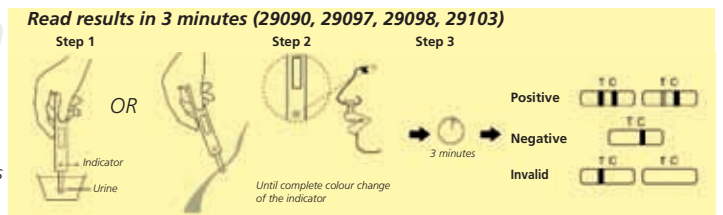
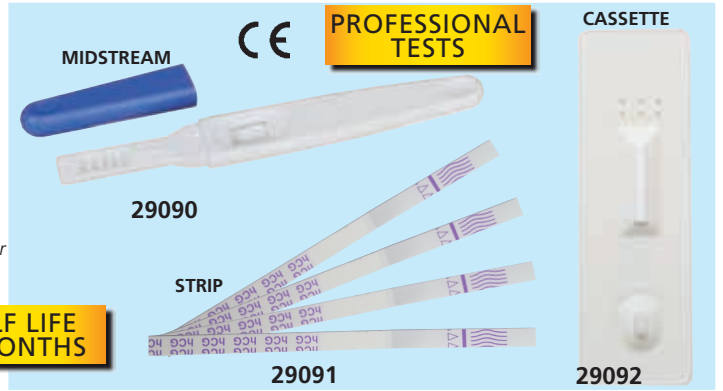

PREGNANCY TESTS			
GIMA code	SELF TESTS	Type	Package
29097	SELF TEST 20 mIU/ml	midstream	box of 1 pc
29098	SELF TEST 20 mIU/ml	midstream	box of 2 pcs
29103	ULTRA SELF TEST 10 mIU/ml	midstream (large wipe)	box of 1 pc
PROFESSIONAL TESTS			
29090	PROFESSIONAL TEST	midstream	box of 25 pcs
29091	PROFESSIONAL TEST	strip 4 mm	box of 50 pcs
29092	PROFESSIONAL TEST	cassette	box of 40 pcs

# ULTRA SENSITIVE OVULATION TESTS

**OVULATION TESTS:**  
Easy to use self test for determination of the highest peak of fertility in woman. Early detection test, 99,9% accurate and clinically tested. Sensitivity: 35 mIU/ml (29124), 30 mIU/ml (29125). All products are packed in single aluminium pouches in a cardboard boxes with multilingual user manual (GB, IT, ES, FR, GR, PT, DE, PL). Tests have 24 months expiry at production time. Our stock may vary from 10 to 22 months. Results in 3 minutes (29124) or 5 minutes (29125).

GIMA code	OVULATION TESTS	Type	Package
29124	SELF TEST	midstream	box of 5 pcs
29125	SELF TEST	strip 4 mm	box of 25 pcs



# BASAL THERMOMETER

• 25608 DIGITAL BASAL THERMOMETER °C - hang box - water-proof  
With 4 digits, 2 decimals, for fertility control.

**4 DIGITS, 2 DECIMALS**

CE 0476



# PREGNANCY DISC

• 29099 PREGNANCY DISC  
Forecasts the forthcoming date of birth. Used by obstetrician and practitioners. Useful for assessment of drug administration. 2 rotating discs riveted in the center: 108 mm diameter (base), 76 mm diameter (top). Can be personalized with your logo for minimum 1,000 pcs.



**YOUR LOGO HERE**  
minimum 1,000 pcs.

## CHLAMYDIA RAPID TEST

• **29117 CHLAMYDIA TEST - box of 20 tests**  
Provide accurate results in 10 minutes, giving doctors immediate diagnosis. High sensitivity and specificity. Each box includes 20 tests, reagents, female cervical swabs, tubes, droppers, pipette and user manual. For professional use.



CE 0123

**Male/Female swab specimen**  
- Add reagent A and B to specimen  
- Add 3 drops of extracted specimen  
- Read results after 10 minutes

**Male urine specimen**  
- Add reagent B and A to specimen  
- Add 3 drops of extracted specimen  
- Read results after 10 minutes

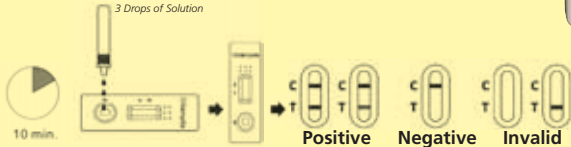

## VAGINITIS TEST KIT

The test includes:  
1 test + vaginal swab  
+ fluid specimen  
(buffer solution)  
in single box +  
English/Italian  
manual

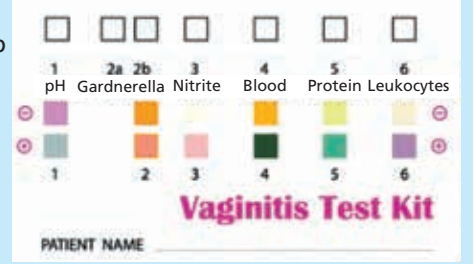

CE

### • 29111 VAGINITIS TEST KIT

A unique, easy-to-use and revolutionary test for gynecologists and operators. Finds the causes of the inflammation/vaginal infection in just 10 minutes. It replaces traditional bacterial tests that take days and costs only a tenth. When necessary dilute vaginal fluid specimen in a buffer solution and then transfer to reagent pad. The instruction manual contains a result guide and can be used to recognize: Trichomoniasis, negative gram bacteria, Gardnerella, Chlamydia, serious bacterial vaginitis. For professional use.

## GYN&CUBE PESSARY

• **29887 GYN&CUBE PESSARY Ø 28/38 mm, h 38 mm - standard**  
• **29888 GYN&CUBE PESSARY Ø 32/44 mm, h 44 mm - large**  
Silicone, autoclavable, latex free pessary with pyramidal shape and draining holes. Kevlar reinforced lanyard. Multilingual instructions: GB, FR, IT, ES, DE, NL.

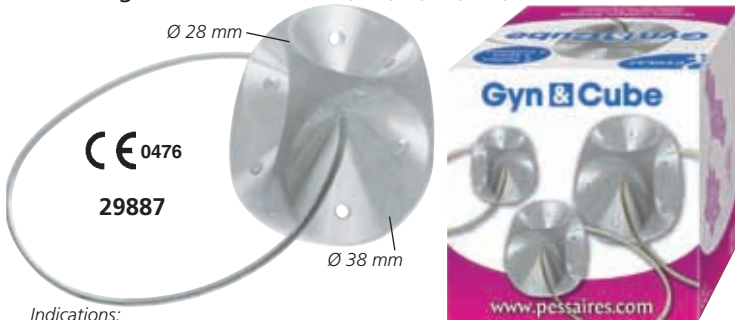

**Indications:**  
- stress urinary incontinence during sustained exertion (aerobics, tennis, jogging)  
- moderate or exteriorized prolapse - moderate cystocele and rectocele  
- after childbirth, transient prolapse or incontinence.

## VAGINAL PH TEST

The kit contains:  
10 cotton swabs +  
10 reagent strips in  
an individual box  
with user manual  
(English + Italian)

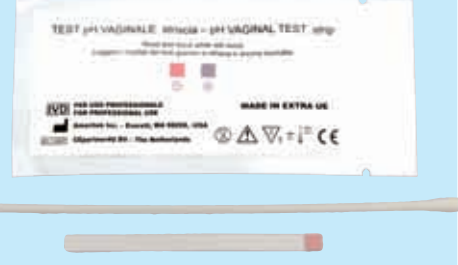

CE

### • 29110 VAGINAL PH TEST - box of 10 pcs.

Quick test to determine vaginal PH.  
An easy routine test to check vaginal PH in just 1 minute to make sure it is within the physiological limits (< 4.7). An increase in the Ph level may indicate a change in the vaginal environment. This could mean there is a possible vaginitis. The test is ideal for pregnant women and for women with particular diseases such as diabetes. For professional use.

## RUBBER AND SILICONE PESSARY FOR UTERINE PROLAPSE - LATEX FREE

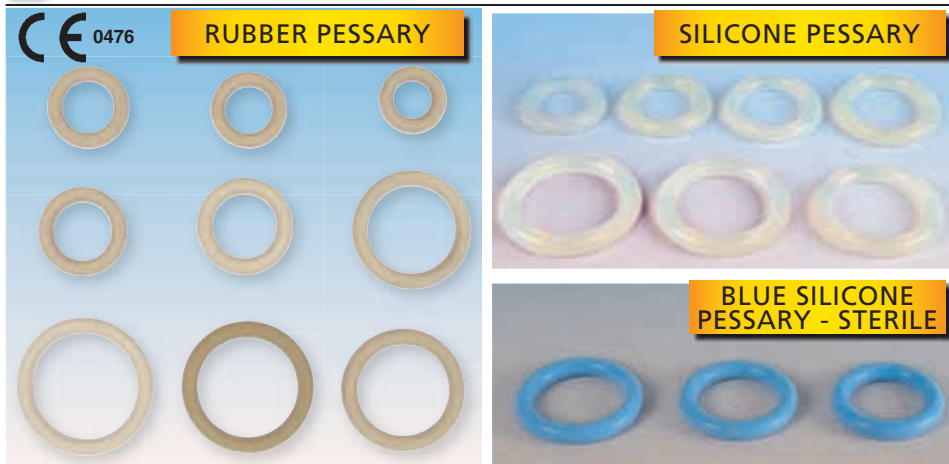

Individually packed in cardboard box. Multilingual box and instructions: GB, FR, IT, ES, PT, DE, GR.



GIMA code	RUBBER PESSARY - autoclavable*
30010	Rubber Pessary Ø 55 mm
30011	Rubber Pessary Ø 60 mm
30012	Rubber Pessary Ø 65 mm
30013	Rubber Pessary Ø 70 mm
30014	Rubber Pessary Ø 75 mm
30015	Rubber Pessary Ø 80 mm
30016	Rubber Pessary Ø 85 mm
30017	Rubber Pessary Ø 90 mm
30018	Rubber Pessary Ø 95 mm
30019	Rubber Pessary Ø 100 mm
SILICONE PESSARY - autoclavable*	
29892	Silicone Pessary Ø 55 mm
29893	Silicone Pessary Ø 60 mm
29894	Silicone Pessary Ø 65 mm
29895	Silicone Pessary Ø 70 mm
29896	Silicone Pessary Ø 75 mm
29897	Silicone Pessary Ø 80 mm
29898	Silicone Pessary Ø 85 mm
29899	Silicone Pessary Ø 90 mm
29900	Silicone Pessary Ø 95 mm
29901	Silicone Pessary Ø 100 mm
BLUE SILICONE PESSARY** - autoclavable*	
29905	Blue silicone Pessary Ø 70 mm
29906	Blue silicone Pessary Ø 75 mm
29907	Blue silicone Pessary Ø 80 mm

\*Autoclavable at 121°C/15 min or 134°C/10 min for up to 3 times  
\*\*Sterile

## DIATERMO MB 122 AND MB 160 MONO-BIPOLAR - 120 W - 160 W



- 30540 DIATERMO MB 122 - mono-bipolar - 120 W
  - 30541 DIATERMO MB 160 - mono-bipolar - 160 W
- MB 122 and 160 are HF electrocautery units suitable to perform middle monopolar or bipolar electrocautery. By selection of the modes of operation they provide pure cut, coagulated cut, forced coagulation, soft coagulation and, with forceps, bipolar coagulation. The use of either split or normal neutral plate is allowed. MB 160 is recommended in case of damp operational fields, for instance mucous, with consequent need to have reserve of usable power. For these reasons, MB 160 is suggested for Gynecological and orthopedic surgery.
- Leading-Edge Technology.** This advanced concept device enables highly professional surgery intervention thanks to ergonomic and safety features derived from high power theatre apparatus.
- Complete safety.** Open Circuit (OC) Alarm warns the user that connection into the neutral plate has not been made or that the cable is disconnected or the neutral plate is not in contact with the patient. The alarm is signaled by an intermittent beep together with a flashing red light on the front panel. In this case HF emission for cut and coagulation operation is switched off.
- OVT Alarm.** The unit includes an internal circuit protection warning when the current delivery is exceeding.

### STANDARD ACCESSORIES

- MB single-use two button handle
- MB waterproof foot-switch 30577 (usable as alternative to handle)
- MB flat neutral plate with cable 30564
- Power cable 2 m
- Kit of 6 (MB 122) or 10 (MB 160) short autoclavable electrodes, diam. 2.4 mm
- User manual: available in GB, ES, IT, FR, PL

\*Does not include foot switch and MB flat neutral plate with cable

### TECHNICAL SPECIFICATIONS

	MB122	MB160	Crest Factor
Minimum preselectable power	0	0	
Level step	1	1	
Maximum output power CUT (W)	120 250Ω	160 250Ω	1.5
Maximum output power BLEND (W)	90 200Ω	120 200Ω	2.1
Maximum output power COAG FORCED (W)	80 150Ω	100 150Ω	2.0
Maximum output power COAG SOFT (W)	60 100Ω	80 100Ω	1.7
Maximum output power BIPOLAR (W)	40 100Ω	60 100Ω	1.5
Working frequency	600 kHz	600 kHz	
Weight kg	7	7	
Size LxHxD mm	260x110x265	260x110x265	
Operating voltage (switchable)	115 -230	115 -230	
Mains frequency (Hz)	50-60	50-60	
Fuses 230Vac (5x20) TIMED	2x 3.15A	2x 3.15A	
Fuses 115Vac (5x20) TIMED	2x 6.3A	2x 6.3A	
Electrical input power (VA)	300	350	
Electrical input current (230 Vac) (A)	1.3	1.5	
Electrical input current (115 Vac) (A)	2.6	3	
Five steps adjustable sound level (from 55- to 75dBA)	•	•	
Self-check	•	•	
Power accuracy output warning	•	•	
Split or not split patient plate allowed	•	•	
Last working condition storing	•	•	
Electrical Class (EN60601 - 1)	I CF	I CF	
MDD 93/42/EEC Class	II b	II b	
Patient circuit	F	F	

## MONOPOLAR ELECTROSURGERY UNIT - 50 W



- 30516 DIATERMO 106 - 50W - monopolar

This HF electrocautery unit is particularly suitable for small operations and is recommended for dentistry, first aid and dermatology work. It offers precision of cut and immediate coagulation and give excellent results in a wide range of applications: from uterine coagulation to microcoagulation in dermatology. The modes of operation, CUT, COAG or BLEND,



0051

### TECHNICAL SPECIFICATIONS

Output power: CUT	50 W/400 ohm
COAG	40 W/400 ohm
BLEND	45 W/400 ohm
Working frequency:	600 kHz ±10%
Size: 180x180x100 mm	Weight: 2.8 kg
Operating Voltage: 115/230 V - 50/60 Hz switchable	
Electric input power: 90 VA	Fuse: 2x1 AT
Alarm for overheating	Footswitch operating
Norms: EN60601-1 Class I CF, EN60601-2-2 93/42/EEC (Class IIb)	
Warranty: 12 months	

### STANDARD ACCESSORIES

- KIRKY single-use handle without buttons
- MB waterproof foot-switch (30577)
- Flat neutral plate with cable (30564)
- Kit of 6 short autoclavable electrodes, Ø 2.4 mm, length 5 cm
- Power cable 2 m - Schuko plug
- User manual: available in GB, IT, ES, FR

can be easily selected by a switch on the front panel. The complete isolation between patient and the unit and strict respect of international norms guarantee total safety.

# MONO-BIPOLAR ELECTROSURGICAL UNITS 80W, 120W, 160W



CASUALTY SURGERY  
 PEDIATRIC SURGERY\*  
 PLASTIC SURGERY\*  
 VASCULAR SURGERY  
 DERMATOLOGY  
 FIRST AID  
 OTORHINOLARYNGOLOGY  
 UROLOGY\*  
 GYNAECOLOGY  
 VETERINARY  
 DENTISTRY\*\*  
 \*Diatermo MB160 only  
 \*\*Diatermo MB120 only



- 30627 DIATERMO MB 80D - mono-bipolar - 80 W
- 30628 DIATERMO MB 120D - mono-bipolar - 120 W
- 30629 DIATERMO MB 160D - mono-bipolar - 160 W

30629



Diatermo MB are high frequency electrocautery units suitable for minor and medium surgery.

MB allows pure CUT, cut-coagulation BLEND, superficial coagulation FORCED COAG, deep coagulation in absence of necrosis SOFT COAG and, with forceps, BIPOLAR coagulation. The digital reading of delivered power and the monitoring of operative function by microcontroller guarantee absolute reliability of working conditions.

MB allows a highly professional surgery through ergonomic features. Neutral electrode connection and patient/plate contact are constantly monitored.

The possibility of output functions and output power delivery control, by handle, allows surgical procedures without divert attention from operation field.

Features:

- minimum invasive surgery
- possibility to use bipolar forceps
- possibility to use split neutral electrodes
- memorization of the last used settings
- power activation by pedal and/or handle
- digital adjustment and indication of the output power
- adjustment of the acoustic indicator intensity.

TECHNICAL SPECIFICATIONS			
	MB 80D	MB 120D	MB 160D
Max output power CUT	80 W-250 Ω	120 W-250 Ω	160 W-250 Ω
Max output power BLEND	60 W-250 Ω	90 W-200 Ω	120 W-200 Ω
Max output power FORCED COAG	50 W-150 Ω	80 W-150 Ω	100 W-150 Ω
Max output power SOFT COAG	40 W-100 Ω	60 W-100 Ω	80 W-100 Ω
Max output power BIPOLAR	30 W-100 Ω	40 W-100 Ω	60 W-100 Ω
Working frequency	600 kHz	600 kHz	600 kHz
Patient circuit	F	F	F
Selectable input voltage	115 - 230 Vac	115 - 230 Vac	115 - 230 Vac
Mains frequency	50 - 60 Hz	50 - 60 Hz	50 - 60 Hz
Electrical input power	230 VA	300 VA	350 VA
Size WxHxD mm	254x104x288	254x104x288	254x104x288
Weight	5 kgs	5 kgs	5 kgs
Controls:	Patient/Plate circuit monitoring, Output power monitoring, Self check control		
Safety:	EN60601-1, EN60601-1-2, EN60601-2-2, Electrical Class: I CF, MDD 93/42/EC Class: II b		

**STANDARD ACCESSORIES**

MB single use two button handle  
 MB waterproof foot switch 30577 (usable as alternative to handle)  
 MB flat neutral plate with cable (30564)  
 Kit of 10 short autoclavable electrodes, Ø 2.4 mm. Power cable: 2 m  
 User manual: GB, IT, available on request FR, ES, PL

# MONOPOLAR ELECTROSURGERY UNITS 50W AND 80W



DENTISTRY  
 DERMATOLOGY  
 OUT PATIENT SURGERY  
 FIRST AID  
 VETERINARY\*  
 VASCULAR SURGERY\*  
 \*Diatermo 80 only

- 30625 DIATERMO 50 - monopolar
- 30626 DIATERMO 80 - monopolar

30625

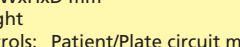

Diatermo 50 and 80 are radiofrequency electrocautery units suitable for minor monopolar surgery.

Diatermo 50 through the function selection makes pure cut, cut coagulation (CUT 1 - CUT 2) and pure coagulation possible. Diatermo 80 has a multifunction selector which makes cutting (CUT), cut coagulation (BLEND), coagulation (COAG) and micro-coagulation (MICRO) possible. The one-board microcontroller and digital display guarantee high safety and reliability under any conditions. They offer outstanding professional surgical results due to their ergonomic and superior safety features.

TECHNICAL SPECIFICATIONS		
	50	80
Max output power CUT	50 W-400 Ω	80 W-400 Ω
Max output power CUT/COAG1	45 W-400 Ω	-
Max output power CUT/COAG2	40 W-400 Ω	-
Max output power BLEND	-	60 W-400 Ω
Max output power COAG	40 W-400 Ω	50 W-400 Ω
Max output power MICRO	-	20 W-600 Ω
Working frequency	600 kHz	700 kHz
Patient circuit	F	F
Selectable input voltage	115 - 230 Vac	115 - 230 Vac
Mains frequency	50 - 60 Hz	50 - 60 Hz
Electrical input power	200 VA	230 VA
Size WxHxD mm	190x85x239	190x85x239
Weight	2.5 kg	2.5 kg
Controls:	Patient/Plate circuit monitoring, Output power monitoring, Self check control	
Safety:	EN60601-1, EN60601-1-2, EN60601-2-2, Electrical Class: I CF, MDD 93/42/EC Class: II b	

**STANDARD ACCESSORIES**

Single use handle  
 MB waterproof foot switch (30577)  
 MB flat neutral plate with cable (30564)  
 Kit of 6 short autoclavable electrodes, Ø 2.4 mm, length 5 cm (30501/2/4/7/9/10) see page 229  
 Power cable 2 m - Schuko plug  
 User manual: GB, IT, available on request FR, ES

# MONO-BIPOLAR ELECTROSURGICAL UNIT 200W



OUTPATIENT SURGERY  
ENDOSCOPY  
FIRST AID  
GASTROENTEROLOGY  
GENERAL SURGERY  
GYNAECOLOGY  
NEUROSURGERY  
ORTHOPEDICS  
OTORHINOLARYNGOLOGY  
PEDIATRIC SURGERY  
PLASTIC SURGERY  
PNEUMOLOGY  
UROLOGY  
VASCULAR SURGERY  
VETERINARY

MADE IN ITALY

## • 30630 DIATERMO MB 200D - 200 W

MB 200D is a high frequency electrocautery equipment suitable for light and medium surgery, allows minimally invasive surgical procedure of resection, evaporation and coagulation. MB 200D allows pure CUT, Cut-Coagulation BLEND, incision with reduced production of eschar ENHANCED, superficial coagulation FORCED COAG, deep coagulation in absence of necrosis SOFT COAG and BIPOLAR coagulation. Digital reading of delivered power and surveillance through microcontroller of the operational functions, assure absolute reliability of working conditions.

MB 200D allows a highly professional surgery through ergonomic and safety features. The connection of neutral electrode is constantly monitored. Safety control of patient/plate contact using split neutral electrode. Possibility to control the output functions and the delivery of output power by the handle, allows the surgical operation without diverting attention from the surgical field.

- patient-to-plate contact control

### STANDARD ACCESSORIES

MB two-button autoclavable handle (30536)  
MB waterproof foot-switch (30577)  
Flex steel neutral plate with cable (30555 + 30560)  
Kit 10 short standard electrodes, Ø 2.4 mm (30500) Power cable 5 m  
3 needle + 3 blade + 3 ball electrodes 7 cm Manual: available in GB, IT

- split return electrode use
- minimally invasive surgical treatment allowed
- monopolar and Bipolar independent output
- auto Start/Stop in Bipolar Coag
- working condition planning
- power delivery by pedal and/or handle
- digital regulation and indication of the output power
- sound level control
- adjustable power increment



### TECHNICAL SPECIFICATIONS

Maximum output power CUT	200W - 250Ω
Maximum output power ENHANCED	120W - 250Ω
Maximum output power BLEND	120W - 200Ω
Maximum output power FORCED COAG	150W - 150Ω
Maximum output power SOFT COAG	90W - 100Ω
Maximum output power BIPOLAR COAG	80W - 50Ω
Working frequency	600 kHz
Patient circuit	F
Mains voltage	115-230 Vac
Mains frequency	50-60 Hz
Electrical input power	350 VA
Size WxHxD mm	370x144x319
Weight	6 kgs
Controls:	Patient/Plate circuit monitoring, Output power monitoring, Self check control
Safety:	EN60601-1, EN60601-2-2, EN60601-2-2, Electrical Class: I CF, MDD 93/42/EC Class: II b

# DIATERMO MB 200 - MONO-BIPOLAR - 200W



30542

MADE IN ITALY

### STANDARD ACCESSORIES

MB two-button autoclavable handle (30536)  
MB waterproof foot-switch 30577 (usable in alternative to handle)  
MB flat neutral metal plate with cable (30564)  
Kit 10 short standard electrodes, Ø 2.4 mm (30500)  
Power cable 2 m Manual: available in GB, IT

## • 30542 DIATERMO MB 200 - 200 W

DIATERMO MB200 is a HF electrocautery unit suitable to perform middle monopolar or bipolar electrocautery. The available waveforms and peak voltage value, as well as the accurate HF leakage current operation for polypectomy, TURP, intrauterine resections, endometriosis excision, etc. The units allow the accurate preset of the output power with as low as 1 Watt resolution and to perform coagulation by high crest factor current, to get an elevated thermal effect, as well as with low voltage low crest factor current, to get coagulation in absence of carbonization. Ten different programs related to ten different operative conditions could be stored and easily recalled by the surgeon. The use of either split or normal neutral plates are allowed. A special electronic circuit (Skin Plate Electronic Control) continuously checks if the plate is safely connected to the patient and detects unwanted short circuit in the connecting cable. An over time warning (OVT) is provided to prevent excessive heating of the tissue around the surgical target due to too long current delivery time.

### TECHNICAL SPECIFICATIONS

Maximum output power CUT (W)	200	250Ω	1.5	Weight kg	8
Maximum output power CUT 90% (W)	200	250Ω	1.6	Size LxHxD mm	360x150x265
Maximum output power CUT 80% (W)	200	250Ω	1.7	Selectable mains power(Vac)	115 -230
Maximum output power CUT 70% (W)	200	250Ω	1.8	Mains frequency (Hz)	50-60
Maximum output power BLEND (W)	120	200Ω	2.1	Fuses 115Vac - 230Vac (5x20) TIMED	2x 6.3A - 2x 3.15A
Maximum output power COAG FORCED (W)	150	150Ω	2.0	Power accuracy output warning system	•
Maximum output power COAG SOFT (W)	90	100Ω	1.7	Split or not split patient plate allowed	•
Maximum output power BIPOLAR COAG (W)	100	100Ω	1.5	Electrical Class (EN60601 - 1)	I CF
Maximum output power BIPOLAR CUT (W)	120	250Ω	1.5	MDD 93/42/EEC Class	II b
Working frequency	600 kHz			Patient circuit	F
				Duty cycle (action/pause) in seconds	10/30

# MB 200 TOUCH MONO-BIPOLAR ELECTROSURGICAL UNIT 200W

**• 30693 DIATERMO MB 200 T - 200W**

High Frequency electrosurgical equipment suitable for precision mono and bipolar surgery and micro-surgery, without tissue alterations. It can also supply HF operative powers for programmable time as short as hundredths of a second. The unit allows pure CUT, cut-coagulation BLEND, incision with reduced production of eschar ENHANCED, superficial coagulation FORCED COAG, deep coagulation in absence of necrosis SOFT COAG, bipolar CUT, COAG and SEALING, FULGURATION.

The digital reading of delivered power and the operational functions overseen through microcontroller, assure absolute reliability of work conditions. Diatermo MB 200 T allows a highly professional surgery due to user-friendly and safety solutions normally used. The neutral electrode and patient/plate safety control are constantly monitored. The possibility of output functions and output power delivery control, by handle, allows to perform surgery avoiding the surgeon to take his eyes off the operational field.

**Software**  
Developed to provide a simple, functional and intuitive work experience. Through one finger touch, you can customize screen, work settings, change cut or coagulation power and manage each device function.

- STANDARD ACCESSORIES**
- Flex steel neutral plate with cable (30555+30560)
  - Kit 10 short standard electrodes Ø 2.4 mm (30500)
  - Power cable 5 m
  - Holder for handle and electrodes
  - Reusable handle with switches (30536)
  - Waterproof footswitch (30577)



30693

CASUALTY (R)	NEUROSURGERY (R)	PNEUMOLOGY (R)
ENDOSCOPY (R)	ORTHOPAEDICS (U)	TRANS URETHRAL RESECTION TUR (U)
FIRST AID (R)	OTORHINOLARYNGOLOGY (R)	UROLOGY (R)
GASTROENTEROLOGY (R)	PAEDIATRIC SURGERY (U)	VASCULAR SURGERY (R)
GENERAL SURGERY (U)	PLASTIC SURGERY (U)	VETERINARY (R)
GYNECOLOGY (R)		

R = recommended U = usable

MADE IN ITALY

**TECHNICAL SPECIFICATIONS**

<b>Max power:</b>			
PURE CUT	200 W - 300 Ω	FULGURATION	100 W - 1000 Ω
BLEND	150 W - 300 Ω	BIPOLAR SEALING	200 W - 50 Ω
ENHANCED	150 W - 300 Ω	BIPOLAR COAG	120 W - 50 Ω
FORCED COAG	150 W - 200 Ω	BIPOLAR CUT	120 W - 50 Ω
SOFT COAG	100 W - 200 Ω		

RF power pulse: emission time 10 ms - 30 sec, interval 1-30 F  
 Patient circuit: F  
 Selectable input voltage: 100 - 240 Vac - 750 VA  
 Working frequency: 360 KHz  
 Size (WxHxD) - Weight: 370x145x300 mm - 6 kg  
 Controls: Patient/Plate circuit monitoring, Output power monitoring, Self check control  
 Safety: EN60601-1; EN60601-1-2; EN60601-2-2  
 Electrical classification: I CF MDD 93/42 / EC: II b

# MONO-BIPOLAR ELECTROSURGICAL UNITS 120W AND 200W



**• 30631 DIATERMO MB 120 FLASH**      **30631**  
**• 30633 DIATERMO MB 200 FLASH**

Professional High Frequency ElectroSurgical equipment suitable for precision monopolar and bipolar surgery and micro-surgery without tissue alterations. Surgical treatments with programmable timer operations up to milliseconds or with traditional mode. MB FLASH allow pure CUT, cut-coagulation BLEND, incision

**TECHNICAL SPECIFICATIONS**

	MB 120F	MB 200F
Max output power CUT	120 W-250 Ω	200 W-250 Ω
Max output power BLEND	90 W-200 Ω	120 W-200 Ω
Max output power ENHANCED	90 W-250 Ω	120 W-250 Ω
Max output power FORCED COAG	80 W-150 Ω	150 W-150 Ω
Max output power SOFT COAG	60 W-100 Ω	90 W-100 Ω
Max output power BIPOLAR COAG	60 W-50 Ω	80 W-50 Ω
Working frequency	600 kHz	600 kHz
RF power pulse emission time	10ms - 30sec	10ms - 30sec
RF power pulse interval	1 - 9	1 - 9
Patient circuit	F	F
Selectable input voltage	115 - 230 Vac	115 - 230 Vac
Mains frequency	50 - 60 Hz	50 - 60 Hz
Electrical input power	300 VA	350 VA
Size WxHxD mm	370x144x319	370x144x319
Weight	6 kg	6 kg

Controls: Patient/Plate circuit monitoring, Output power monitoring, Self check control  
 Safety: EN60601-1, EN60601-1-2, EN60601-2-2, Electrical Class: I CF, MDD 93/42/EC Class: II b

OUTPATIENT SURGERY	PEDIATRIC SURGERY**	PODIATRY**
DERMATOLOGY	FIRST AID	PNEUMOLOGY**
VASCULAR SURGERY	PLASTIC SURGERY**	UROLOGY**
GYNECOLOGY	ENDOSCOPY	VETERINARY
DENTAL*	OPHTHALMOLOGY	GASTROENTEROLOGY
OTORHINOLARYNGOLOGY	NEUROSURGERY**	ORTHOPAEDICS**

\*Diatermo MB 120 only      \*\*Diatermo MB 200 only

MADE IN ITALY

with reduced production of eschar ENHANCED, superficial coagulation FORCED COAG, deep coagulation in absence of necrosis SOFT COAG and BIPOLAR coagulation. Digital reading of delivered power and the surveillance through microcontroller of the operational functions, assure absolute reliability of the working conditions. Connection of neutral electrode is constantly monitored. Safety control of patient/plate contact using split neutral electrode. Possibility to control the output functions and the delivery of output power by handle, allows surgical operation without diverting attention from the surgical field.

Features:

- patient to plate contact control
- split return electrode use allowed
- minimally invasive surgical treatment allowed
- monopolar and Bipolar independent output
- auto Start/Stop in Bipolar Coag
- working condition planning
- power delivery by pedal and/or handle
- digital regulation and indication of the output power
- sound level control
- adjustable power increment
- RF power pulse emission time setting and interval setting

**STANDARD ACCESSORIES**

MB two-button autoclave handle (30536)	2 disposable rem ground pads (30493)
Flex steel neutral plate with cable (30555-30560)	Power cable 5m
MB waterproof footswitch (30577)	Microsurgery handle (30552)
Kit 10 short standard electrodes Ø 2.4 mm	Microsurgery needles 10 pieces
3 needle + 3 blade + 3 ball electrodes 7 cm	Manual: GB, IT

# HIGH POWER ELECTROSURGICAL UNITS 300 AND 400 WATT



- 30634 DIATERMO MB 300D
- 30635 DIATERMO MB 400D

DIATERMO MB300D and MB400D are high frequency electro-surgical equipments suitable to supply power for monopolar cut and coagulated cut (with different levels of coagulation), bipolar cut and coagulation.

### TWIN OPERATIVE ACTIVITY

- two output channels for monopolar cutting
- two independent setting and output channels for the most frequent monopolar coagulation

### CONTROLLED CUTTING PROCEDURES

- enhanced cutting current for eschar free incision
- cutting current with selectable coagulating property for bleeding controlled dissection
- low capacitive coupling by slow BLEND current for endoscopic procedures

### TWIN CONTROLLED COAGULATION PROCEDURES

- SPEEDY coagulation and DEEP coagulation available to two operators
- SPRAY coagulation by hand switch or foot switch controls

### EXTENSIVE BIPOLAR FEATURES

- bipolar cutting current with selectable bleeding control

- slow BLEND cutting current
  - automatic start/stop coagulation functions
- ### SURGEON AND PATIENT TOTAL SAFETY
- acceptability of contact impedance between patient body and return electrode continuously monitored by Skin Plate Electronic Control (SPEC)
  - H.F. Leakage currents continuously monitored
  - mains fluctuation automatically compensated before delivery of HF power

### PERSONALIZED PROCEDURES

- independent choice of coagulation currents and power levels by each of two operators
- up to 10 procedures can be configured and re-called

### EXTENSION DRIVER AND INTERLOCK SIGNALS

- driven output connection to external Argon Plasma unit and Smoke Evacuator unit

### AUTOMATIC SELF DIAGNOSIS

- automatic diagnostic control of the complete functionality of electronic unit and connected accessories with coded report of failures

MADE IN ITALY



OUTPATIENT SURGERY  
GENERAL SURGERY  
PAEDIATRIC SURGERY  
PLASTIC SURGERY  
THORAX SURGERY  
VASCULAR SURGERY  
DERMATOLOGY  
ENDOSCOPY

GASTROENTEROLOGY  
GYNAECOLOGY  
NEUROSURGERY  
ORTHOPEDICS  
OTORHINOLARINGOLOGY  
PNEUMOLOGY  
UROLOGY  
VETERINARY

30634

### TECHNICAL SPECIFICATIONS MB300/MB400

	MB 300	MB 400
Maximum out power monopolar pure CUT	300 W - 300 Ω	400 W - 300 Ω
Maximum out power monopolar cut-coag CUT80%	250 W - 300 Ω	350 W - 300 Ω
Maximum out power monopolar cut-coag CUT60%	200 W - 300 Ω	250 W - 300 Ω
Maximum out power monopolar cut-coag CUT40%	150 W - 300 Ω	200 W - 300 Ω
Maximum out power monopolar cut ENHANCED	200 W - 500 Ω	250 W - 500 Ω
Maximum out power monopolar cut-coag BLEND	200 W - 300 Ω	250 W - 300 Ω
Maximum out power monopolar coag SPEEDY	100 W - 500 Ω	120 W - 500 Ω
Maximum out power monopolar coag DEEP	100 W - 200 Ω	120 W - 200 Ω
Maximum out power monopolar coag SPRAY	70 W - 2000 Ω	100 W - 2000 Ω
Maximum out power monopolar coag SPRAY ARGON	70 W - 2000 Ω	100 W - 2000 Ω
Maximum out power bipolar CUT	95 W - 150 Ω	95 W - 150 Ω
Maximum out power bipolar cut-coag CUT80%	95 W - 150 Ω	95 W - 150 Ω
Maximum out power bipolar cut-coag CUT60%	95 W - 150 Ω	95 W - 150 Ω
Maximum out power bipolar cut-coag CUT40%	60 W - 150 Ω	60 W - 150 Ω
Maximum out power bipolar cut-coag BLEND	90 W - 150 Ω	90 W - 150 Ω
Maximum out power bipolar cut-coag BLEND	70 W - 100 Ω	70 W - 100 Ω
Working frequency monopolar / bipolar	425 kHz / 525 kHz	425 kHz / 525 kHz
Patient circuit	F	F
Selectable input voltage	115-230 Vac	115-230 Vac
Mains frequency	50-60 Hz	50-60 Hz
Electrical input voltage	1000 VA	1000 VA
Size WxHxD mm	470x150x400	470x150x400
Weight	17.5 Kgs	17.5 Kgs
Controls:	Patient/Plate circuit monitoring, Output power monitoring, Self check control	
Safety:	EN60601-1, EN60601-1-2, EN60601-2-2, Electrical Class: I CF, MDD 93/42/EC Class: II b	

### STANDARD ACCESSORIES

- 1 - Power supply cord 5 m
- 1 - Two-button autoclavable handle (30536)
- 5 - Two-button cold sterilizable handle (30551)
- 1 - Flex steel neutral plate (30555)
- 1 - Cable for flex plate (30560)
- 5 - Rem disposable ground pads (30493)
- 2 - HP double Water proof foot switch (30604)
- 3 - Short, general surgery blade electrode 7 cm
- 3 - Long, general surgery blade electrode 16 cm
- 3 - Short, general surgery ball electrode Ø 4 mm, 6 cm
- 1 - Electrode brush
- 1 - User manual (IT, GB)
- 1 - Service manual (IT, GB)





# ELECTROSURGICAL UNITS TOUCHSCREEN 300 AND 400 WATT



USE	300	400
DERMATOLOGY	R	U
ENDOSCOPY	R	U
GASTROENTEROLOGY	R	R
GENERAL SURGERY	R	R
GYNECOLOGY	R	U
NEUROSURGERY	R	R
ORTHOPAEDICS	U	R
OTORHINOLARYNGOLOGY	R	U
PAEDIATRIC SURGERY	R	R
PLASTIC SURGERY	R	R
PNEUMOLOGY	R	U
THORAX SURGERY	U	R
TRANS URETHRAL RESECTION (TUR)	U	R
UROLOGY	R	R
VASCULAR SURGERY	U	U
VETERINARY	R	U

R= recommended U= usable



MADE IN ITALY

- 30695 DIATERMO MB 300 T
- 30697 DIATERMO MB 400 T

Diatermo MB 300 T and MB 400 T, the new generation of electrosurgery, that allows two surgeons to work simultaneously.

A radiofrequency generator suitable for microsurgery and precise surgery in monopolar and bipolar modality. The simplicity of new Diatermo MB 300 T and MB 400 T allows you to use it without learning time, resulting in time savings. The initial setup and setting adjustments, during a surgery, can be easily selected through the large touchscreen.

- Performance, usability, design and reliability**
- simultaneous activation of monopolar and bipolar
  - power control depending on impedance
  - activating power with pedal and / or handpiece
  - neutral-patient electrode contact control
  - cutting function under saline solution TUR
  - modular cut in wet conditions BLEND
  - vessel sealing to clamp vessels up to 7 mm
  - possibility of use for minimally invasive surgery
  - monopolar / bipolar functions
  - auto-start / auto-stop in bipolar modality
  - adjusting sound intensity

**An intuitive and logic work environment**  
Diatermo MB 300 T and MB 400 T have a particularly basic and intuitive work environment.

Horizontal matching between monitors, RGB light indications and connectors provide a clear and easy-to-read overview. The large 9" capacitive touchscreen, designed with a sleek flat front, ensures faster and more efficient cleaning in the operating room.

**State of the art device**  
Highly professional surgery with ergonomic and safety solutions. Neutral electrode connection is constantly monitored: if a split neutral plate is used, the device will monitor the contact between the patient and the electrode.

STANDARD ACCESSORIES	
Flex steel neutral plate with cable (30556+30560)	
3 blade electrodes - 7 cm	Reusable handle with switches (30536)
3 blade electrodes - 16 cm	MB waterproof foot switch (30608)
3 ball Ø 4 mm electrodes - 6 cm	Power cable 5 m

The possibility to switch the functions and active the power supply from the handpiece, allows surgical procedures without divert attention from operation field.

**Software**  
Developed to provide a simple, functional and intuitive work experience. Through one finger touch, you can customize and save your work settings, change the cut or coagulation power and manage each device function.



	TECHNICAL SPECIFICATIONS	
	MB 300 T	MB 400 T
Maximum output power PURE CUT	300 W - 300 Ω	400 W - 300 Ω
Maximum output power BLEND	200 W - 300 Ω	250 W - 300 Ω
Maximum output power ENHANCED	200 W - 300 Ω	250 W - 300 Ω
Maximum output power FORCED COAG	120 W - 150 Ω	150 W - 150 Ω
Maximum output power SOFT COAG	120 W - 200 Ω	150 W - 200 Ω
Maximum output power FULGURATION	80 W - 500 Ω	100 W - 500 Ω
Maximum output power BIPOLAR TUR	250 W - 200 Ω	300 W - 200 Ω
Maximum output power BIPOLAR CUT	150 W - 100 Ω	150 W - 100 Ω
Maximum output power BIPOLAR COAG	150 W - 50 Ω	150 W - 50 Ω
Maximum output power BIPOLAR SEALING	250 W - 50 Ω	250 W - 50 Ω
Working frequency	360 kHz	360 kHz
Patient circuit	F	F
Selectable input voltage	100-240 Vac	100-240 Vac
Mains frequency	50-60 Hz	50-60 Hz
Electrical input voltage	1000 VA	1000 VA
Size WxHxD mm	450x200x420	450x200x420
Weight	15.5 kg	15.5 kg

**Controls:** Patient/Plate circuit monitoring, Output power monitoring, Self check control, HF leakage currents control, Compensation of mains fluctuation  
**Safety:** EN60601-1, EN60601-1-2, EN60601-2-2, Electrical Class: I CF, MDD 93/42/EC Class: II b

## LAPAROSCOPIC STERILE ELECTRODES

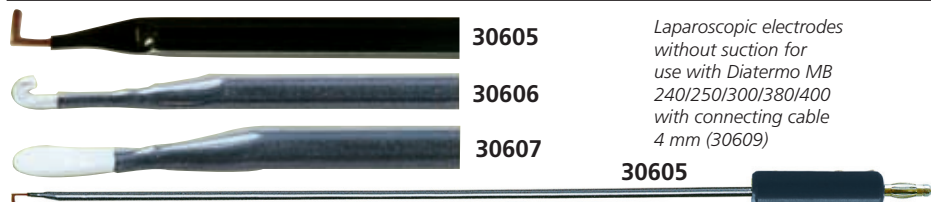

Laparoscopic electrodes without suction for use with Diatermo MB 240/250/300/380/400 with connecting cable 4 mm (30609)

GIMA code	LAPAROSCOPIC ELECTRODES - sterile
30605	L-Hook electrode - 36 cm
30606	J-Hook electrode - 36 cm
30607	Spatula electrode - 36 cm
30609	Monopolar cable - 4 mm - M - F - 3 m

## LOOP ELECTRODES Ø 2.4 mm - AUTOCLAVABLE OR DISPOSABLE



**AUTOCLAVABLE 20 TIMES**

GIMA code	LOOP ELECTRODES - Ø 2.4 mm autoclavable at 134°C - non sterile	Shaft length	Electrode width	Electrode depth
30686	Square loop electrode	13 cm	10 mm	8 mm
30687	Loop electrode	13 cm	15 mm	8 mm
30688	Loop electrode	13 cm	20 mm	10 mm



**STERILE**

GIMA code	LOOP ELECTRODES - Ø 2.4 mm disposable - sterile	Shaft length	Electrode width	Electrode depth	Minimum order
30677	Square loop electrode	13 cm	10 mm	8 mm	box of 10
30678	Loop electrode	13 cm	15 mm	8 mm	box of 10
30679	Loop electrode	13 cm	20 mm	10 mm	box of 10

## AUTOCLAVABLE ELECTRODES Ø 2.4 mm

GIMA code	Reference number	AUTOCLAVABLE ELECTRODES Ø 2.4 mm	Reference number	GIMA code
length 5 cm		minimum order: 6 pcs.	length 10 cm	
30501	1	Electrode wire 0.2 - straight	21	30521
30502	2	Electrode wire 0.2 - angled 45°	22	30522
30503	3	Electrode bend - Ø 4 - straight	23	30523
30504	4	Electrode bend - Ø 8 - straight	24	30524
30505	5	Electrode hook - angled 45°	25	30525
30506	6	Electrode wire 1 mm.- angled 45°	26	30526
30507	7	Electrode straight slip-knot - straight	27	30527
30508	8	Electrode angled slip-knot - straight	28	30528
30509	9	Electrode ball point - Ø 3 mm - angled 45°	29	30529
30510	10	Electrode ball point - Ø 3 mm - straight	30	30530
30500	SET	Set of 10 electrodes	SET	30531
length 7 cm		minimum order: 10 pcs.	length 15 cm	
30511	15	Needle electrode	35	30532
30512	16	Blade electrode	36	30533
30513	17	Ball electrode Ø 4 mm	37	30534

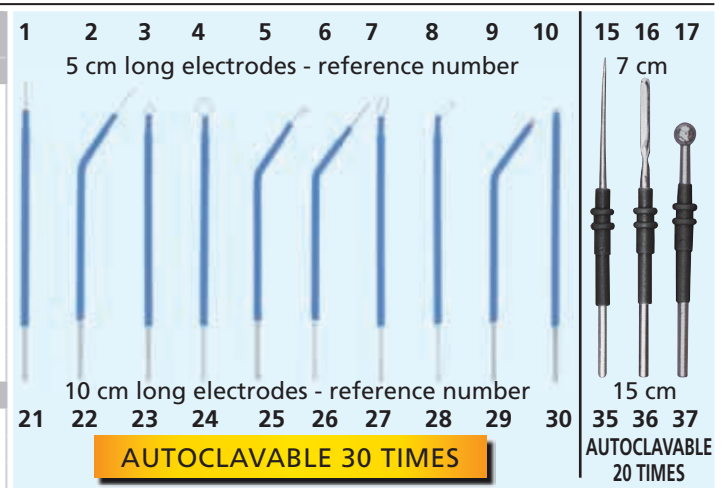

5 cm long electrodes - reference number

10 cm long electrodes - reference number

7 cm

15 cm

**AUTOCLAVABLE 30 TIMES**

AUTOCLAVABLE 20 TIMES

## SINGLE USE STERILE ELECTRODES Ø 2.4 mm

Length		SINGLE USE ELECTRODES Ø 2.4 mm
7 cm	15 cm	Sterile electrode - box of 24
30670	30674	Needle electrode - sterile electrode
30671	30675	Blade electrode - sterile
30672	30676	Ball Ø 4 mm electrode - sterile

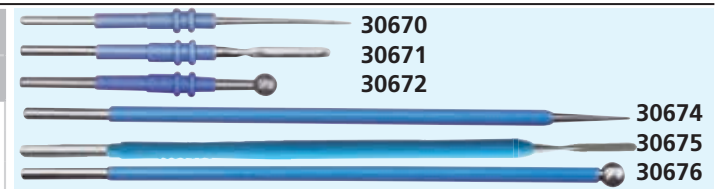

## SINGLE USE NON-STICK STERILE ELECTRODES Ø 2.4 mm

GIMA code	NON-STICK SINGLE USE ELECTRODE Ø 2.4 mm	Length
30420	Blade electrode - sterile	7 cm
30422	Blade electrode - sterile	10 cm
30425	Needle electrode - sterile	10 cm
30429	Ball electrode - sterile	13 cm

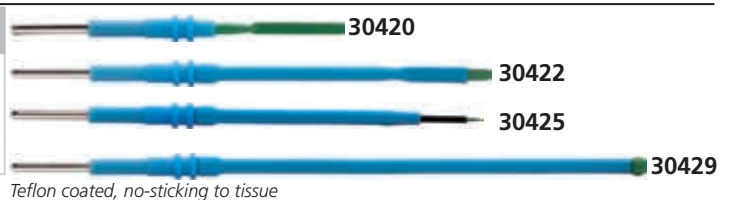

Teflon coated, no-sticking to tissue

## SINGLE USE STERILE TUNGSTEN NEEDLE ELECTRODES Ø 2.4 mm

Straight	Angled	TUNGSTEN MICRO NEEDLE ELECTRODES	Length
30370	30371	Tungsten electrode - sterile	5 cm
30372	30373	Tungsten electrode - sterile	6 cm
30374	30375	Tungsten electrode - sterile	7 cm



Tungsten needle has extremely high melting point (> 3400°C) which helps maintain sharpness.

## ELECTRODE CLEANING PAD

• 30537 ELECTRODE CLEANING PAD - 50x50 mm - box of 100  
Disposable sterile radiopaque abrasive tip cleaner pad.

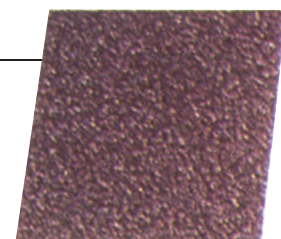

30537

## 3-PIN MONOPOLAR HANDLE AND ELECTRODES Ø 4 mm

• **30480 AUTOCLAVABLE MB HANDLE Ø 4 mm - 100 times**  
Autoclavable handle up to 100 times for Ø 4 mm shaft electrodes with 3 m silicone cable and blade electrode.

- **30482 NEEDLE ELECTRODE Ø 4 mm** 30482
  - **30483 BLADE ELECTRODE Ø 4 mm** 30483
  - **30484 BALL ELECTRODE Ø 4 mm** 30484
- S/S electrodes autoclavable 100 times.  
Sold in box of 5.  
Length 5.5 cm.



## 3-PIN MONOPOLAR HANDLES FOR ELECTRODES Ø 2.4 mm

**VALLEYLAB CONNECTOR HANDLES** with 2 "click" push-buttons GIMA autoclavable electrosurgery pencils with CUT-COAG switch have been studied and tested to offer maximum reliability and functionality to the operator. MB handles are provided with a 3 Pin plug Valleylab type fitting all Gima mono-bipolar Diatermo MB (80, 120, 122, 132, 160, 200, 240, 300, 380, 400) and most of bipolar electrosurgical units: Aspen Lab, ES Generator, EMC Statome, Danieli, Braun, Berchtold, Ohmeda, Ritter, Conmed, Eschmann, Bovie, Martin, Kontron, Bard, Birtcher 771, Cobi, Valleylab, Led, Erbe...

### ■ AUTOCLAVABLE HANDLES

- **30554 MB AUTOCLAVABLE HANDLE - 100 times**  
Autoclavable handle with 2 large "click" push-buttons, provided with a 3 meter long silicone cable and a blade electrode. It can be autoclaved up to 100 times (electrode 20 times).
- **30545 MB AUTOCLAVABLE HANDLE - 100 times**  
Same as code 30554 but with a 5 m long silicone cable
- **30550 PRIMA MB AUTOCLAVABLE HANDLE - 60 times**  
Autoclavable handle with 2 large "click" push-button, provided with a 3 meter long silicone cable and a blade electrode. It can be autoclaved up to 60 times.
- **30548 STAR AUTOCLAVABLE HANDLE - 30 times**  
Same as code 30554 but autoclavable up to 30 times (electrode is autoclavable up to 20 times).
- **30539 ORION PLUS AUTOCLAVABLE HANDLE - 100 times**  
Same as 30554, but with a screw clamp locking system ensuring a safe contact and adapting to slightly different electrode diameters. High insulation to prevent liquid damage.
- **30536 SURGEON AUTOCLAVABLE HANDLE - 100 times**  
Autoclavable, waterproof handle with ergonomic grip. Coloured ring that indicates CUT and COAG push buttons. Provided with 3 m cable and blade electrode.

### ■ SINGLE USE HANDLE

- **30551 KIRKY SINGLE-USE HANDLE - STERILE**  
Single-use handle with "click" push-buttons for cut and coag. Includes blade electrode and 3.20 m cable.
- **30553 GIMA SINGLE-USE HANDLE - STERILE**  
Same as 30551 with 3 m cable.



## 1-PIN MONOPOLAR HANDLES FOR ELECTRODES Ø 2.4 mm

**1 pin plug HANDLES** for diatermo 50, 80, 106, 108

These handles are provided with a 1 Pin socket (4 mm) fitting all Gima Diatermo and most of electrosurgical units in the market. These handles **do not have push-buttons**.

- **30515 SURGEON 1 PIN AUTOCLAVABLE HANDLE - 100 times**  
Autoclavable, waterproof handle with ergonomic grip. Provided with 3 m cable and blade electrode
- **30519 AUTOCLAVABLE 50-80-106-108 HANDLE**  
Autoclavable handle without buttons, provided with a 3 meter long cable and a blade electrode. It can be autoclaved up to 100 times.
- **30518 KIRKY SINGLE-USE 50-80-106-108 HANDLE - STERILE**  
Single-use handle without button with blade electrode with 4 mm PIN connection.



## MONOPOLAR FORCEPS, SCISSORS AND CABLES

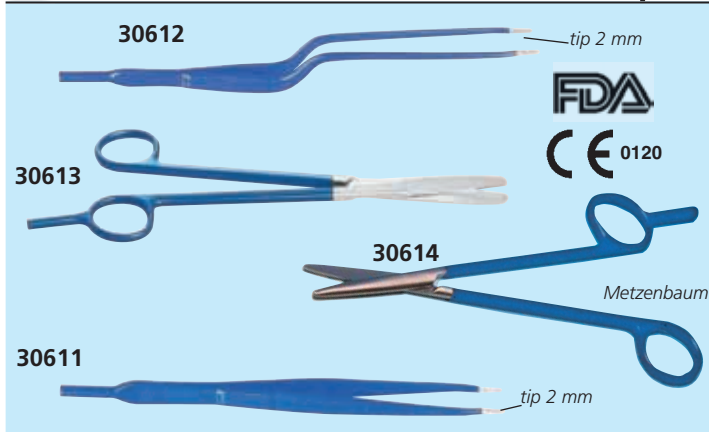

Monopolar forceps and scissors are provided with a 4 mm connection for standard monopolar cables. These can be used with all Gima, LED, Erbe and many other electro-surgical units in the market.

GIMA code	INSULATED MONOPOLAR INSTRUMENTS
30610	Monopolar cable - 4 mm pin - 3 m
30611	Mc INDOE straight monopolar forceps 15 cm (6")
30612	Bayonet monopolar forceps - 20 cm (7 1/2")
30613	Monopolar scissors - straight - 18 cm (7")
30614	Metzenbaum monopolar scissors - straight - 18 cm (7")
30615	Metzenbaum monopolar scissors - curved - 18 cm (7")

## 3M ELECTROSURGICAL GROUNDING PADS WITH SAFETY RING

- 30496 3M 9160 SPLIT GROUNDING PAD - box of 100
  - 30497 3M 9160F SPLIT GROUNDING PAD - box of 200 (40 pouches of 5 pieces)
  - 30498 3M 9165 SPLIT GROUNDING PAD - precorded - box of 40
- The 3M Universal Grounding Pads all have a conductor area of 15 square inches and come with the patented 3M Green Safety Ring technology which allows them to perform the same as grounding pads that are up to 33% larger in conductor area. Green Ring allows adult and pediatric use.

They have fluid resistance, non-woven backing which allows heat to pass through up to 25% faster than foam, and they have no minimum age or weight limit.



**3M** 30496, 30497 (3M 9160)

## HANDLES FOR ELECTROLYSIS NEEDLES

Needle handles for all GIMA Diatermo and electro-depilators

- 30552 HANDLE for electrolysis needles
- 30415 PROFESSIONAL HANDLE for electrolysis needles



## BALLET STERILE DISPOSABLE ELECTROLYSIS NEEDLES

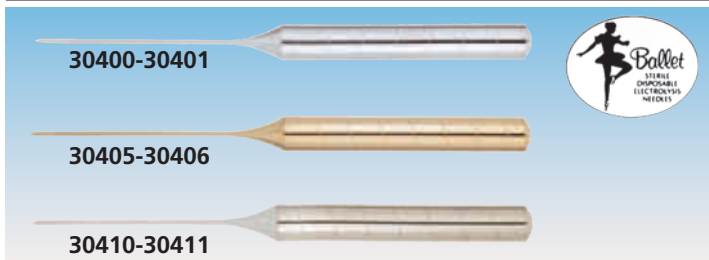

Stainless steel	Gold plated	Insulated	ELECTROLYSIS NEEDLES - STERILE	Minimum order
30400	30405	30410	K2 needle - 0.055 mm (0.002")	box of 50
30401	30406	30411	K3 needle - 0.075 mm (0.003")	box of 50

**Ballet needles**  
Manufactured with a precise point and a mirror-like surface polish. The rounded tapered point of the needle assists the electrologist in locating the follicle opening and upon insertion the needle will slide smoothly and accurately to the base of the follicle.

**Stainless steel needles**  
Ideal for patients with strong healthy skin who respond well to electrolysis treatment.

**Insulated needles**  
Suggested for patients with high sensitivity to discomforts of electrolysis.

**24 carat gold plated needles**  
For clients who suffer from allergies and sensitive skin.



## ELECTRODEPILATOR

• 28340 ELECTRO-DEPILATOR 400  
This device ensures a definitive depilation with thermolytic method. It delivers a current of radiofrequency to cause the heating and consequent coagulation of the papilla, reached through the introduction of a needle into the follicle of the hair. Provided with highly reliable electronic integrated components, with RF intensity adjustable with continuity and luminous working signal. It comes complete with footswitch, handpiece for depilation, depilation needle and power cable (2 m).

### TECHNICAL SPECIFICATIONS

RF output frequency: 1.9 ±10% MHz  
Modulation: sinusoidal  
Maximum output power: 7 ±2Watt  
Size: 260x265x110 mm Weight: 4 kg  
Operating voltage: 115/230 V - 50/60 Hz switchable  
Norms: CEI 62-39 Class: I-BF

- 30552 HANDPIECE FOR DEPILATION
- 30577 FOOTSWITCH



## DISPOSABLE GROUND PADS - WITH/WITHOUT CABLE



GIMA code	DISPOSABLE GROUND PADS WITH SOLID GEL - without cable	Minimum order
30491	REM GROUND PADS - pediatric	box of 25
30487	REM GROUND PADS - pediatric	box of 100
30492	GROUND PADS - adult	box of 25
30489	GROUND PADS - adult	box of 100
30493	REM GROUND PADS - adult	box of 25
30488	REM GROUND PADS - adult	box of 100
30495	REM NON WOVEN GROUND PAD - ad/ped	box of 100

Pads need cable 30563 for Gima diatermo or other cable see below

DISPOSABLE GROUND PADS WITH CABLE - 3m		
30476	PADS WITH CABLE Ø 6.3 mm plug	box of 25
30478	PADS WITH CABLE Valleylab type	box of 25

All plates and cables are individually packed

## CONNECTION CABLES FOR DISPOSABLE GROUND PADS

### CABLES TO CONNECT GROUND PADS TO ELECTROSURGERY UNITS

The bipolar universal connection cables are supplied with a bipolar clamp for connection to disposable ground pads with a tab (dimensions 22-25 mm).

Various connectors make the cables compatible with numerous electrosurgical devices.

The cable can be fixed to the surgical sheet during the operation thanks to a metal sliding clamp.

Latex free. Individually packed in sealed polyethylene pouch compliance to 93/42/EEC

Medical Device Class I.

30563

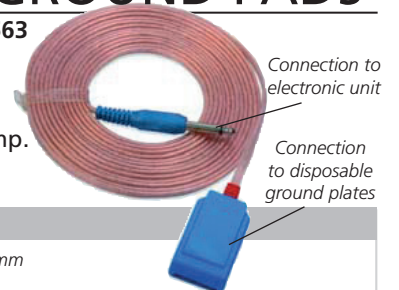

Connection to electronic unit

Connection to disposable ground plates

### COMPATIBLE ELECTROSURGERY UNITS

#### • 30563 CONNECTION CABLE FOR PLATES - 5 m - Universal jack mono plug 6.3 mm

Aesculap: TM, TM401  
 Alexandra: D205, E300, 500D, 102/201, 2020/E, 202, MICRO180  
 ALSA: All  
 MF100, MF360/A360, 380100, 180  
 Berchtold: Elektrotom 200, 390, 400, 540  
 Birtcher: 772, 773, 737, 737XL, 774

Bovie: Bovie CSV, URO, BS, 400/400, 400SR, X10, X10L  
 Burdick: U-7, SU-8  
 Cameron-Miller: 26-1290  
 Cobe: TS-403  
 Concept: 9600, 9700, 9800, 9900  
 Dolley: COBII 203T, 502, 503T, 505T  
 Ems Davol: System 2000, 5000

Faset: Serie COBI  
 Gima: all models  
 GPS: all models  
 I Cuatro: Megeri1  
 Lamidey: Series Subtilec: All  
 Series Surgilec: All  
 Led: all models  
 Martin: all models

Neomed: Series 3000, 3000A, 3002, 3006; 3010, 3020  
 Philips: TS-403  
 Ritter/Mdt: Solide State 400, 400B, 400SR  
 Sidevan: Seb2  
 Soxil: BP 2000, X10  
 Thackray: T300S  
 Torry: Lem 300 CST

#### • 30546 CONNECTION CABLE FOR PLATES - plug with spacer - 5 m - Universal jack mono plug 6.3 mm

Erbe: ACC, ICC, VIO, T

#### • 30547 CONNECTION CABLE FOR PLATES VALLEYLAB TYPE - 5 m - Universal Valleylab connection

Aspenlabs: Excalibur  
 Valleylab: REM type devices  
 Bowa

Conmed  
 Erbe ICC International  
 Erbe ACC International

## AUTOCLAVABLE METAL AND RUBBER PLATES

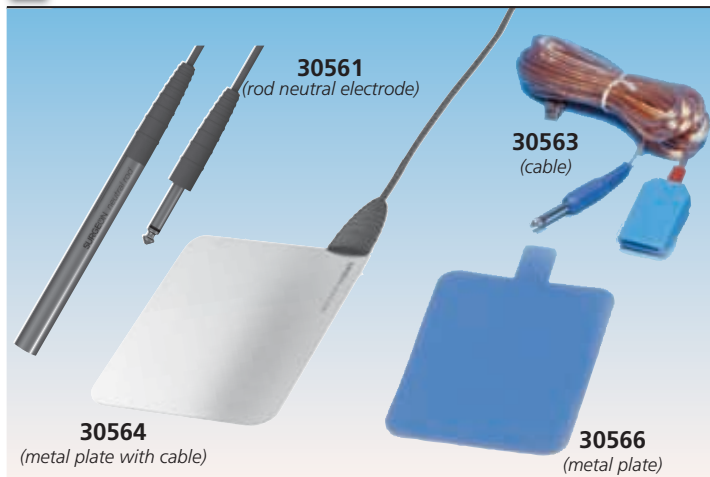

- 30566 METAL PLATE - needs cable 30563
- 30563 CABLE FOR PLATES - 5 m
- 30559 CABLE FOR PLATES - 2.5 m
- 30564 SURGEON NEUTRAL PLATE 16x12 cm - with cable
- 30561 ROD NEUTRAL ELECTRODE with cable for 30625\*

\*Available on request for other electrocautery

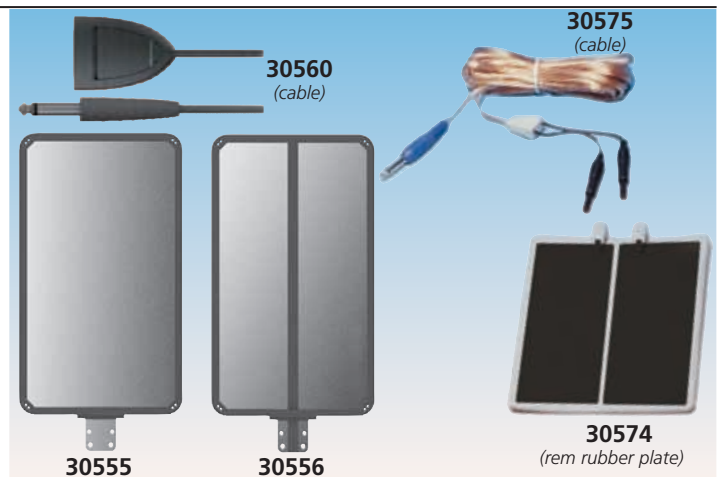

- 30555 FLEXI STEEL RUBBER PLATE 18x21 cm - needs cable 30560
- 30556 FLEXI STEEL REM RUBBER PLATE - needs cable 30560
- 30560 CABLE FOR RUBBER STEEL PLATES 30555 and 30556
- 30574 REM RUBBER PLATE 20x15 cm - needs cable 30575
- 30575 CABLE FOR RUBBER PLATES 30573 and 30574



# BIPOLAR CABLES FOR MAJOR BRANDS

Quality highly flexible silicone bipolar cables 3 m long (10").  
Autoclavable at 134°C for minimum 20 times.  
Recommended EtO sterilization for max extended life.

Suitable for most generators, with connector for European or US forceps. Multilingual box and manual: GB, FR, IT, ES, PT, DE, SE PL, RO,GR, HR, Arabic

<p><b>30642 BIPOLAR CABLE ADAPTOR</b></p>	<p>Connector to forceps</p>	<p>Connector to electro-surgical unit</p>	<p>Connector to forceps</p>	<p>Connector to electro-surgical unit</p> <p>Pin distance 29 mm</p>						
	GIMA Code	<b>30632</b>	<b>30618</b>	<b>30640</b>	<b>30637</b>	<b>30643</b>	<b>30618+ 30642</b>	<b>30617</b>	<b>30644</b>	<b>30639</b>
Connector to forceps	EU	US	EU	US	EU	US	EU	US	EU	EU
Compatibility brand/model	GIMA: MB 240, MB 380 VALLEYLAB, CONMED, CODMAN, OLYMPUS		GIMA: MB 120 F, MB 200 F, MB 200 D, MB 200T, MB 300 D, MB 400 D, MB 300T, MB 400T LED: SURTRON 120, 200, 200T, 300, 300T, 400, 400T VALLEYLAB, EMC, DOLLEY		GIMA: MB 122, MB 160, MB 200, MB 202		GIMA: MB 80 D, MB 120 D, MB 160 D LED: SURTRON 80, 120, 160		MARTIN, BERCHTOLD, AESCULAP, WOLF	ERBE, SELECT, DOWNS, SIEMENS

## DISPOSABLE BIPOLAR FORCEPS - VALLEYLAB CABLE

- 30300 DISPOSABLE JEWELER FORCEPS - 11.5 cm - tip 0.5 mm
  - 30302 DISPOSABLE STRAIGHT FORCEPS - 20 cm - tip 1.0 mm
  - 30304 DISPOSABLE STRAIGHT FORCEPS - 15 cm - angled tip 1.0 mm
  - 30306 DISPOSABLE BAYONET FORCEPS - 20 cm - tip 1.0 mm
- Disposable bipolar forceps are supplied with 3 m cable.  
Valleylab plug (same connector as 30640).  
Sterilization by Ethylene Oxide (EtO).

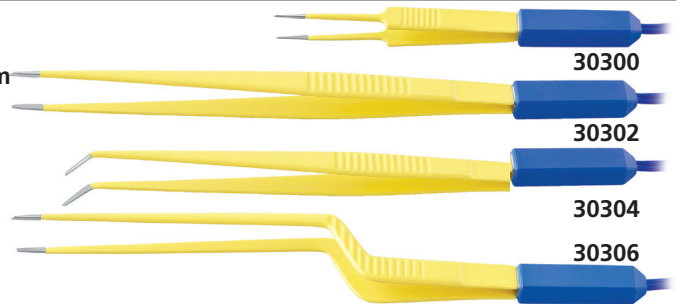
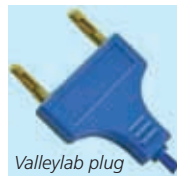

## BIPOLAR SCISSORS

- 30310 BIPOLAR SCISSORS - 18 cm (7") - curved  
Needs bipolar cable 30315
- 30315 ETHICON SILICONE BIPOLAR CABLE - 3 m (10')  
For bipolar scissors. Connector 2.5 mm  
Compatibility: Valleylab, Conmed, Codman, Olympus, other.

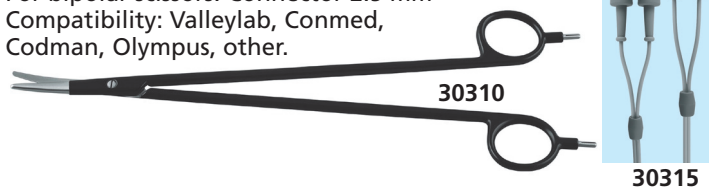

## BIPOLAR ARTERY SEALER

- 30320 BIPOLAR ARTERY SEALER - 26 cm (10.5")  
Needs bipolar cable 30325
- 30325 SILICONE BIPOLAR ARTERY SEALER CABLE - 3 m (10')  
Connector 4 mm, Banana plug.  
Compatibility: Valleylab, Conmed, Codman, Olympus, other.

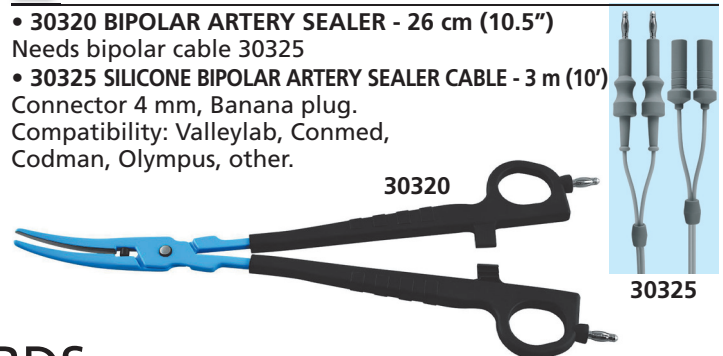

## FOOTSWITCHES AND BOARDS

GIMA code	FOOTSWITCHES FOR 50, 80, 106, MB 120, 122, 132, 160, 200, 202, 200 TOUCH
30577	MB waterproof footswitch - 2m cable
30578	MB waterproof footswitch - 3m cable
ANTIEXPLOSION FOOTSWITCH FOR MB 120, 122, 132, 160, 200, 202	
30602	Double antiexplosion, water proof MB footswitch
ANTIEXPLOSION FOOTSWITCHES FOR MB 240, 300D, 300T, 380, 400, 400D, 400T	
30603	Double antiexplosion, water proof footswitch - MB240-380
30604	Double antiexplosion, water proof footswitch - MB250-400-300D-400D
30608	Double antiexplosion, water proof footswitch - MB300-400 TOUCH
MAIN BOARD	
30557	Main board - specify model and serial number of diatermo with order
30558	Output board for MB 240, 250, 380, 400 - specify as above



It allows selection from pedal of CUT and COAG functions  
Antiexplosion and waterproof.

# UNIVERSAL HIGH QUALITY INSULATED BIPOLAR FORCEPS

## EUROPEAN CONNECTOR BIPOLAR FORCEPS

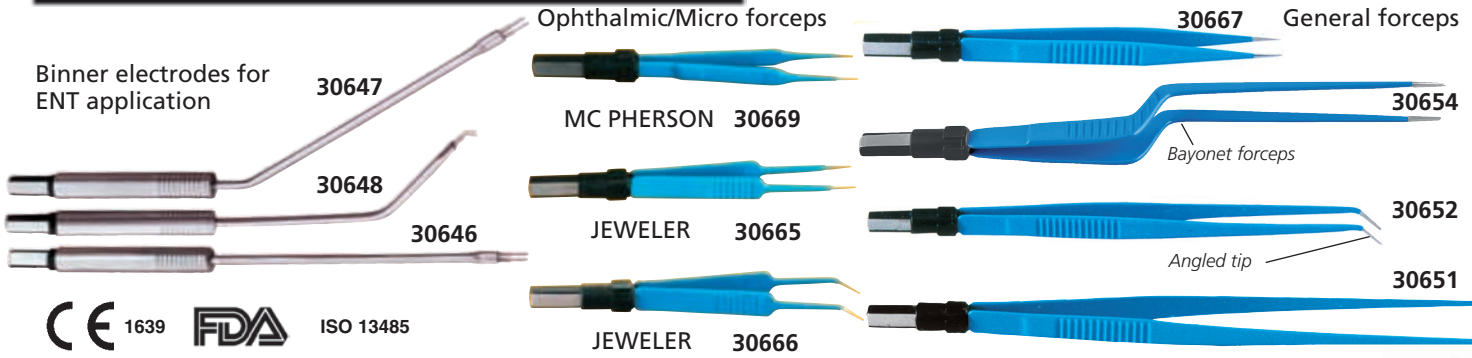

CE 1639 FDA ISO 13485

GIMA code	Model	Connector	Length		Tip style	Application	Tip size
			cm	inches			
30645	BINNER	EU	22 cm	8½"	ANGLED	ENT	-
30646	BINNER	EU	18 cm	7"	STRAIGHT	ENT	-
30647	BINNER	EU	18 cm	7"	ANGLED	ENT	-
30648	BINNER	EU	19 cm	7¾"	ANGLED 45°	ENT	-
30650	STRAIGHT	EU	18 cm	7"	STRAIGHT	GENERAL	1 mm round points
30656	STRAIGHT with irrigation	EU	18 cm	7"	STRAIGHT	GENERAL	1 mm round points
30651	STRAIGHT	EU	20 cm	7¾"	STRAIGHT	GENERAL	1 mm round points
30658	STRAIGHT	EU	20 cm	7¾"	STRAIGHT	GENERAL	2 mm round points
30652	STRAIGHT	EU	18 cm	7"	ANGLED	GENERAL	1 mm round points
30653	STRAIGHT	EU	20 cm	7¾"	ANGLED	GENERAL	1 mm round points
30657	BAYONET	EU	16.5 cm	6½"	STRAIGHT	GENERAL	1 mm round points
30654	BAYONET	EU	18 cm	7"	STRAIGHT	GENERAL	1 mm round points
30655	BAYONET	EU	20 cm	7¾"	STRAIGHT	GENERAL	1 mm round points
30659	BAYONET	EU	22 cm	8¾"	STRAIGHT	GENERAL	1 mm round points
30663	BAYONET	EU	24 cm	9½"	STRAIGHT	GENERAL	1 mm round points
30660	STRAIGHT	EU	18 cm	7"	ANGLED	GENERAL	0.3 mm points
30661	STRAIGHT	EU	18 cm	7"	STRAIGHT	GENERAL	0.3 mm points
30662	STRAIGHT	EU	20 cm	7¾"	STRAIGHT	GENERAL	0.3 mm points
30664	ADSON	EU	12.1 cm	6"	STRAIGHT	GENERAL	1 mm round points
30665	JEWELER 5	EU	11.5 cm	4½"	STRAIGHT	OPHTHALMIC/MICRO	0.25 mm points
30666	JEWELER 5	EU	11.5 cm	4½"	ANGLED	OPHTHALMIC/MICRO	0.25 mm points
30667	STRAIGHT	EU	15 cm	6"	STRAIGHT	OPHTHALMIC/MICRO	0.5 mm points
30668	STRAIGHT	EU	15 cm	6"	ANGLED	OPHTHALMIC/MICRO	0.5 mm points
30669	Mc PHERSON	EU	10.2 cm	4"	STRAIGHT	OPHTHALMIC/MICRO	0.5 mm points

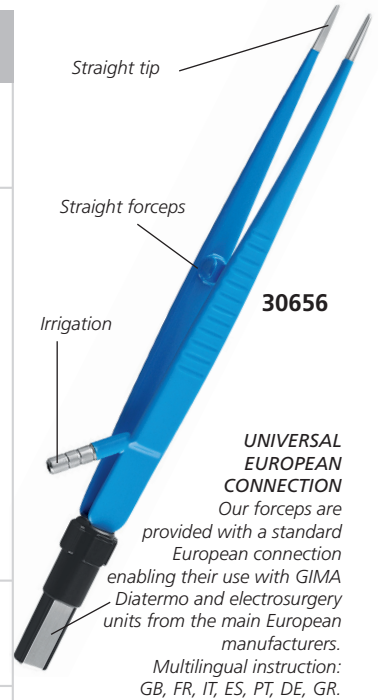

## US CONNECTOR BIPOLAR FORCEPS

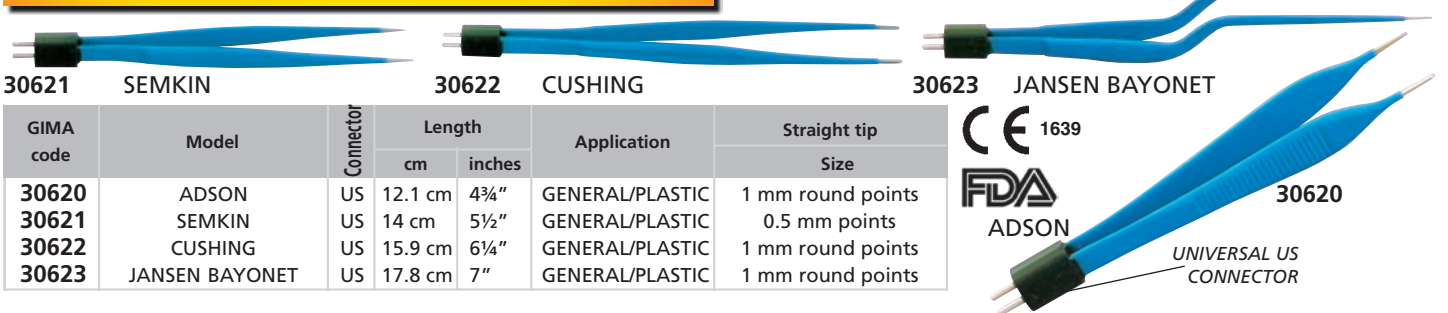

GIMA code	Model	Connector	Length		Application	Straight tip Size
			cm	inches		
30620	ADSON	US	12.1 cm	4¾"	GENERAL/PLASTIC	1 mm round points
30621	SEMKIN	US	14 cm	5½"	GENERAL/PLASTIC	0.5 mm points
30622	CUSHING	US	15.9 cm	6¼"	GENERAL/PLASTIC	1 mm round points
30623	JANSEN BAYONET	US	17.8 cm	7"	GENERAL/PLASTIC	1 mm round points

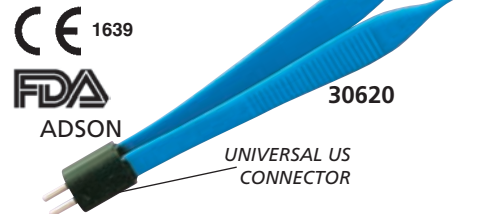

# EUROPEAN NON-STICK BIPOLAR FORCEPS

## NON-STICK BIPOLAR FORCEPS

Thanks to new Ag-Tech non-stick technology, the forceps stay clean, virtually eliminating the need for cleaning during

coagulation. A tip material with excellent thermal properties prevents the sticking of tissues. The non-stick effect is permanent and will not reduce with the use of forceps.

GIMA code	Model	Connector	Length		Tip style	Tip size
			cm	inches		
30460	STRAIGHT	EU	15	6"	STRAIGHT	1 mm
30461	STRAIGHT	EU	18	7"	STRAIGHT	1 mm
30462	STRAIGHT	EU	20	7¾"	STRAIGHT	1 mm
30464	STRAIGHT	EU	18	7"	ANGLED	1 mm
30465	STRAIGHT	EU	20	7¾"	ANGLED	1 mm
30468	BAYONET	EU	18	7"	STRAIGHT	1 mm
30469	BAYONET	EU	20	7¾"	STRAIGHT	1 mm
30472	JEWELER	EU	11.5	4.5"	STRAIGHT	0.7 mm
30473	JEWELER	EU	11.5	4.5"	ANGLED	0.7 mm
30474	ADSON	EU	12.1	4¾"	STRAIGHT	1 mm

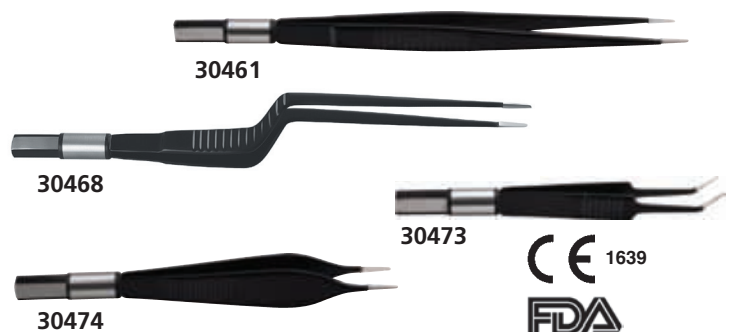

## SMART CARTS FOR ELECTROSURGICAL UNITS

- 27895 SMART CART - 2 shelves 40x36 cm + base
  - 27889 SMART CART - 2 shelves 50x42 cm + base
  - 27890 SMART CART - 2 shelves 60x42 cm + base
- Sturdy carts with painted powder steel base and aluminium frame. 2 shelves with protection edge on back, adjustable at different height. Suitable for all Gima electrosurgical units. Illustrated assembly instructions.

	TECHNICAL SPECIFICATIONS		
	27895	27889	27890
Total load:	80 kg	80 kg	80 kg
Load x shelf:	15 kg	15 kg	15 kg
Size mm:	482x500xh 780	582x500xh 780	682x500xh 780
Weight:	13 kg	15 kg	17 kg

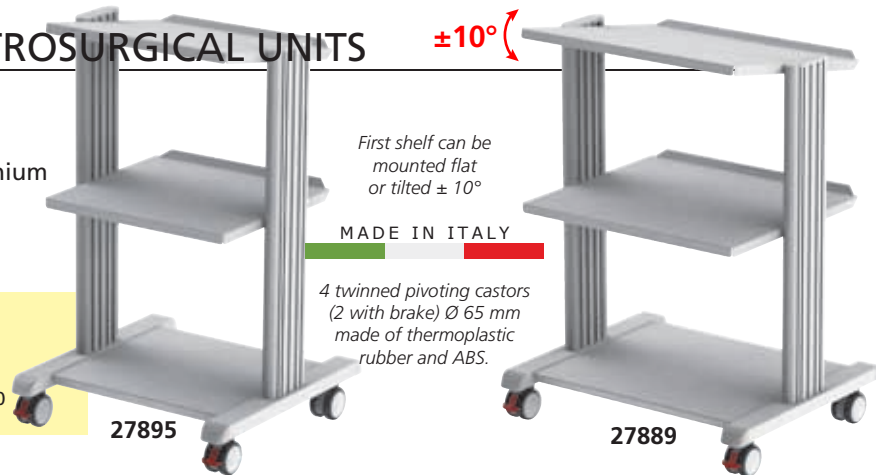

## CARTS FOR ELECTROSURGICAL UNITS

Ergonomic trolley designed to hold and carry electrosurgical units (including Argon units). The height of 915 mm with inclined top shelf allows easy reading of the unit's display. The trolley is provided with a second shelf with antiskid raised edges, two drawers placed at the base and a rear space with securing straps to hold two Argon cylinders. Upright stands can hold optional accessories. Made of epoxy-painted, tempered steel and aluminium. Available version with 4 socket group, fuses box, independent grounding plug, power cable 3m.

TECHNICAL SPECIFICATIONS			
Load capacity:	- Total load 200 kg	- Inclined shelf 50 kg	
Inclined shelf:	42x45 cm (27864/6)	50x36 cm (27865/7)	
Drawers and shelf:	42x36 cm (27864/6)	50x36 cm (27865/7)	

GIMA code	CARTS FOR ELECTROSURGICAL UNITS
27864	DIATERMO CART - medium
27865	DIATERMO CART - large
27866	DIATERMO CART with power - medium
27867	DIATERMO CART with power - large



## ELECTROSURGERY SMOKE EVACUATOR

**• 30450 SMOKE EVACUATOR**  
An aspiration and filtering system for the smokes produced during the surgical procedures. The smokes, generated during the surgical procedures, have a bad, strong and persistent smell. These smokes consist of water vapour, organic gas, visible or invisible solid particles and viral parts. So a good aspiration and filtration eliminates bad smells, reduce the bacteriological and/or viral risks, and improves vision of the zone of the operation area during the laparoscopic procedures.

Activation of the aspiration can be:  
- **Automatic**, through the remote electronic system of automatic survey of the activation of the high frequency electrosurgical unit  
- **Manual**  
- **Through a foot switch (optional)**  
The aspiration flow can be adjusted to suit the specific needs. For laparoscopic procedures there is a specific function L, quickly selectable. Smoke evacuator has an electronic control of the aspiration with the indication of the wearing status of

TECHNICAL SPECIFICATIONS	
Mains voltage:	230 V (115 V on request)
Mains frequency:	50/60 Hz
Electrical input power:	800 VA
Max vacuum flow rate:	1000 LPM (35 CFM)
Max static suction:	250 mbar (83 in H <sub>2</sub> O)
Filter type:	ULPA with active carbons
Filter efficiency:	99,999%
Particles diameter:	0.12 micron
Size:	370x144x319 mm
Weight:	4 kg

STANDARD ACCESSORIES	
ULPA filter (5 hours) blue	
Aspiration kit (A) filter + (B) pipe $\varnothing 22$ mm, length 2.4 m)	
handle aspiration kit (C) adapter 10 mm / 22 mm (D), pipe $\varnothing 10$ mm, length 1.8 m,	
(E) clip to fix the pipe to the handle, (F) adapter to the handle)	
Power cable	

the filters. There are two different kinds of quickly replaceable ULPA type filters, with active carbons: the BLUE filter is the first filter and it is included with the unit for an initial time of use (5 hours), the RED filter is an optional spare part, developed for a long time use (20 hours). They have connector of 7/8".

- 30451 ULPA FILTER (20 hours) RED for 30450 since S.N. 0216383
- 30452 ULPA FILTER (20 hours) RED for 30450 up to S.N. 0216382
- 30453 ASPIRATION KIT - box of 6
- 30454 HANDLE ASPIRATION KIT - sterile - box of 12
- 30577 MB WATERPROOF FOOTSWITCH - 2 m

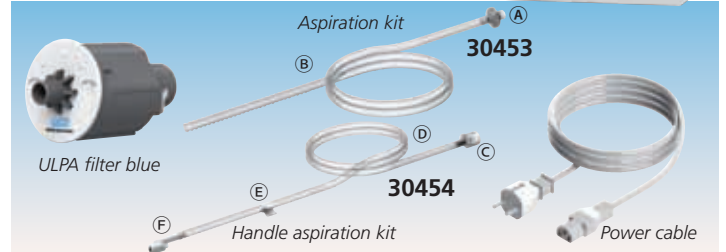



# CHANGE-A-TIP™ CAUTERIES WITH HIGH TEMPERATURES

## BOVIE CAUTERIES

Improved battery-operated cautery with a safety-enhanced design and a recessed button to reduce the potential for inadvertent activation.

It also allows the practitioner to "snapped off" the end of the cautery for safe and effective battery removal.

- interchangeable sterile tips (non sterile tips for 30584 and 30590)
- replaceable batteries
- reusable handles
- no sterilization necessary.



**30590**  
(Fine tip, not sterile, included)

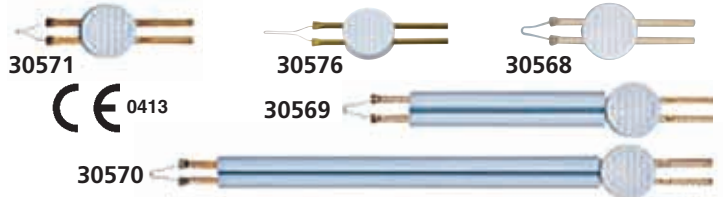

**30584**

Change-A-Tip high-temp cautery, kit including 1 handle, 4 tips (2 as 30568 and 2 as 30571 but not sterile) and 2 AA alkaline batteries in a foam-lined case

GIMA code	CAUTERY HANDLE AND INTERCHANGEABLE STERILE TIPS	Recommended for:	Minimum order
<b>30590</b>	Cautery handle "AA" (tip included)	All tips	1
<b>30568</b>	High temp loop tip	DER/ENT	box of 10
<b>30569</b>	High temp 2" flex loop tip	GYN/ENT	box of 10
<b>30570</b>	High temp 5" loop tip - long size	GYNAECOLOGY	box of 10
<b>30571</b>	High temp fine tip	DER/CARDIO	box of 10
<b>30576</b>	High temp elongated tip	VASECTOMY	box of 10
<b>30584</b>	High temp cautery kit (1 handle + 4 non sterile tips)		

# REUSABLE HIGH TEMPERATURE CAUTERY WITH REPLACEABLE TIP

## CAUTERIES - 1,200°C (2,200°F)

- interchangeable tips with nickel-chrome wire
- replaceable batteries
- reusable handles

Wide application in gynaecology, orthopedy, ear/nose/throat, dermatology and urology.

GIMA code	INTERCHANGEABLE TIP CAUTERIES MINIMUM ORDER: 10 TIPS
<b>30598</b>	Cautery handle "AA" (tip not included)
<b>30599</b>	High temp long fine tip - sterile - box of 10
<b>30600</b>	High temp large tip - sterile - box of 10
<b>30601</b>	High temp fine tip - sterile - box of 10

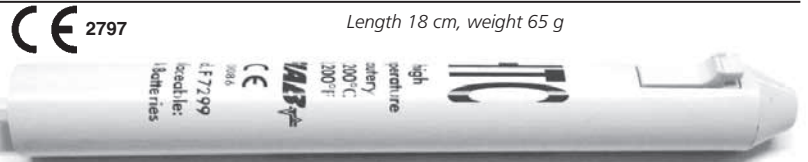

**30598**

Length 18 cm, weight 65 g

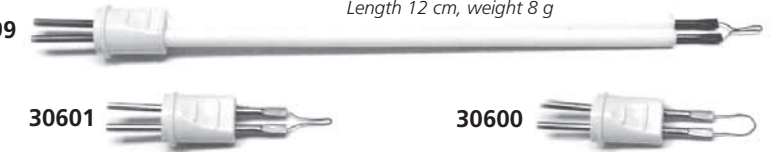

**30599**

Length 12 cm, weight 8 g

**30601**

**30600**

# DISPOSABLE HIGH/MEDIUM/LOW TEMPERATURE CAUTERIES

## • 30700 ELECTROCAUTERY - 1,200°C - fine tip - box of 10

Electrocautery is a sterile bipolar battery operated disposable device for the cauterization of small vessels. With a fine tip required in most of the surgeries.

## • 30701 ELECTROCAUTERY - 1,200°C - large tip - box of 10

Same as 30700, but with a large tip.

## • 30702 LONG SHAFT ELECTRO CAUTERY - 1,200°C - fine tip - box of 10

Same as 30700 but with the tip fixed on a 12 cm long shaft. Precise cauterization even in difficult access sites.

## • 30703 EMERGENCY ELECTROCAUTERY - 800°C - thick tip - box of 10

Same as 30700 but with "thick tip" for the perforation of nails in case of haematoma.

## • 30704 ELECTROCAUTERY - 600°C - fine tip - box of 10

Same as 30700 but with lower temperature 600°C. Especially designed for ophthalmology.

Applications	30700	30701	30702	30703	30704
Cardiovascular, thoracic surgery	x				
Proctology	x	x	x		
General surgery			x		
Gynaecology	x				
Surgical gynaecology			x		
Neurosurgery	x	x	x		
Orthopedic	x	x			
Urology	x				
Obstetrics	x				
Emergency ward				x	
Otolaryngology	x	x	x		
Plastic and reconstructive	x	x			
Ophthalmology	x				x
Dermatology	x				
Dental surgery	x				



**30700**

Length 18 cm

Long life internal battery (60 min.)



**30701**

Same as 30700 but with the tip fixed on a 12 cm long shaft. Precise cauterization even in difficult access sites.



**30702**

Shaft 12 cm long

Long life internal battery (60 min.)



**30703**

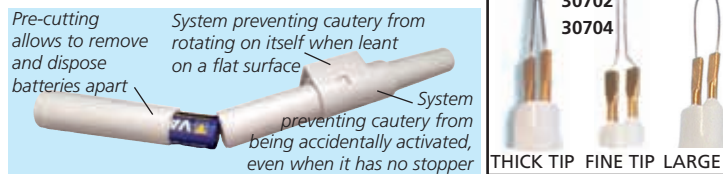

Pre-cutting allows to remove and dispose batteries apart

System preventing cauterization from rotating on itself when leant on a flat surface

System preventing cauterization from being accidentally activated, even when it has no stopper

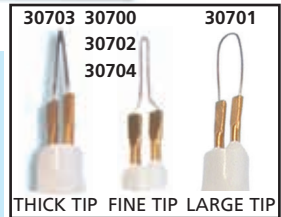

Features	HTC (High Temperature Cautery)			MTC (Med. Temp. Cautery)	LTC (Low. Temp. Cautery)
	30700	30701	30702	30703	30704
Tip shape	Fine	Large	Fine	Thick	Fine
Tip length	28mm	28mm	125mm	28mm	28mm
Temperature °C/°F	1200/2200	1200/2200	1200/2200	800/1400	600/1100
Weight	65g	65g	78g	65g	45g

# HISTOFREEZER® CRYOSURGICAL SYSTEM

- **30591 HISTOFREEZER® - kit with applicator 2 mm**  
Two 80 ml aerosol bottles and 60 applicators 2 mm.
- **30592 HISTOFREEZER® - kit with applicator 5 mm**  
Two 80 ml aerosol bottles and 52 applicators 5 mm.
- **30589 HISTOFREEZER® - large kit mixed applicators**  
Two 80 ml aerosol bottles, 24 applicators 2 mm, 36 applicators 5 mm.
- **30585 HISTOFREEZER® - mini kit mixed applicators**  
One 80 ml aerosol bottle, 16 applicators 2 mm, 16 applicators 5 mm.

The Histofreezer® portable cryosurgical system is a low cost, highly effective cryosurgical agent that provides safe and effective treatment for warts and other common benign skin lesions. This therapeutic treatment makes use of local freezing for the controlled destruction or removal of living tissue. Suitable for adults and children.

Multilingual box and manual in: GB, FR, IT, DE, ES, NL, PL. From web you can download: GR, PT, TH, Arabic. For professional use only.

Saturated 2 mm applicators will stay cold for 90 seconds.



30591

Saturated 5 mm applicators will stay cold for 120 seconds.



30592



30585



30589

9 types of benign lesions	% of resolution*
Verruca Vulgaris (Common Warts)	94%
Verruca Plantaris (Plantar Warts)	86%
Molluscum Contagiosum	100%
Lentigo (Age Spots)	100% - facial 99% - non facial
Condyloma (Genital Warts)	89%
Seborrheic Keratosis	95%
Acrochordon (Skin Tags)	100%
Verruca Plana (Flat Warts)	93%
Actinic keratosis (Facial and Non-Facial)	91% - facial 87% - non facial

\*Summary of resolution rates by type of lesion from a number of clinical trials obtained with histofreezer + post-treatment of 27% salicylic acid / 17% lactic acid

2 mm  
5 mm

**CHARGE**  
custom applicator press valve until droplets start to form.

**INVERT**  
canister for 15 seconds for optimal freezing temperature.

**APPLY**  
a frozen applicator to lesion for 15-40 seconds.

# CRYOMEGA® AND CRYOCLEAR® MULTI-USE CRYOSURGICAL DEVICES

• **30586 CRYOMEGA® with 16 g cartridge - non-refillable**  
CryoOmega® dispenses liquid nitrous oxide (-89°C) the coldest portable cryogen and it is cleared for 16 common lesions including verrucae, skin tags, and seborrheic keratoses. Ideal choice in portable cryosurgery for physician offices looking for convenience and great first-time outcomes. It provides clinically effective freezing with pinpoint precision. No contact device for use on different patients at 1 cm distance. Up to 300 seconds treatment time per device (approx 30 treatments of 10 seconds). For medical healthcare professionals.



**N<sub>2</sub>O**  
-89°C



Type of Lesion	Freeze time range (sec)*
Verruca Vulgaris	10-20
Verruca Plantaris	10-20
Molluscum Contagiosum	3-10
Skin Tags	5-10
Lentigo	2-5
Actinic Keratosis	5
Verruca Plana	5-15
Seborrheic Keratosis	5-10
Genital Lesions	5-12

\*Suggested freezing time as reported in literature

• **30587 CRYOCLEAR® with 16 g cartridge - non-refillable**  
CryoClear® uses Carbon Dioxide which freezes at -79°C to a depth of no more than 2 mm into the skin, delivering a safe and clinically effective treatment to superficial skin indications. Over 95% high efficacy combined with less destruction of healthy tissue makes it perfect for treating age spots, sun spots, and skin tags. It offers a better and faster cryotherapy solution, even as combination treatment to chemical peels, facials, micro-needling or dermaplaining. No contact device for use on different patients at 0.5 cm distance. Up to 300 seconds treatment time per device (approx 60 treatments of 5 seconds). Suggested for use at aesthetics and cosmetic sites.



**CO<sub>2</sub>**  
-79°C

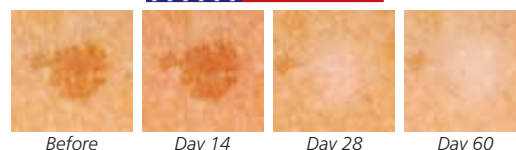

Indication	Freeze time range (sec)*
Acne (cysts and scars)	5-10
Actinic Keratosis (sun spots)	5-10
Angiomas	5-10
Angiomas - spider angiomas	5-10
Keratosis Pilaris (Milia)	5
Lentigo (Age Spots)	5-10
Sebaceous Hyperplasia	5
Skin Tags	5-10
Teleangiectases	None suggested

\*Suggested freezing time as reported in literature

## FLEXIBLE NOSEPHARYNGOSCOPE

### • 71604 FLEXIBLE NOSEPHARYNGOSCOPE with cable

The high precision multi-lens optics creates an optimal image. The thin insertion tubes are exceptionally maneuverable and have a special wide angle lens whereby a precise tip control and a remarkable depth of focus are reached. High quality materials guarantee excellent and homogeneous illumination.

The handpiece is ergonomically formed and the insertion tube is especially comfortable for the patient.

This naso-pharyngoscope, with its proven design, is guaranteed to bring years of trouble-free service.

- wide angle, multi-lens objectives for excellent image quality
- excellent ergonomics allows one hand operation
- suitable for mechanical cleaning and disinfection.

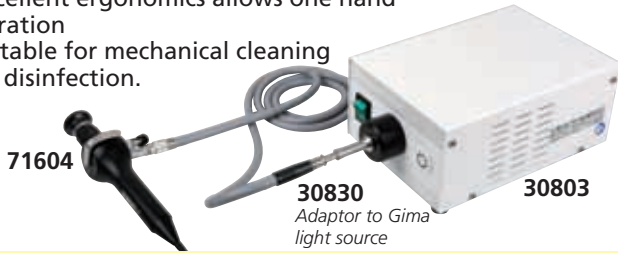

71604

Lever

ETO valve

3.8 mm diameter

MADE IN EUROPE

Tip deflection



Supplied in lightweight aluminium rigid case with fibre optic cable, leakage tester and user manual (GB, IT)

TECHNICAL SPECIFICATIONS 71604	
Resolution: 12,000 pixels	Working length: 300 mm
Working Ø: 3.8 mm	Total length: 535 mm
Length of tip deflection: 20 mm	Tip deflection: up 140°, down 140°
Direction of view: 0°	Depth of focus: 6-1,000 mm
Weight: 260 g	Field of view: 70°

### • 71610 ENDOSCOPY MOUTHPIECE - bag of 20 pcs Disposable bite blocks

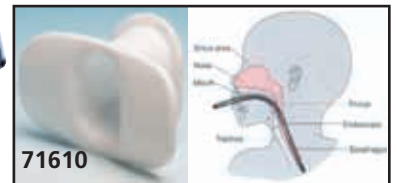

71610

## OTOSCOPIES

ACMI / WOLF / STORZ / OLYMPUS fitting

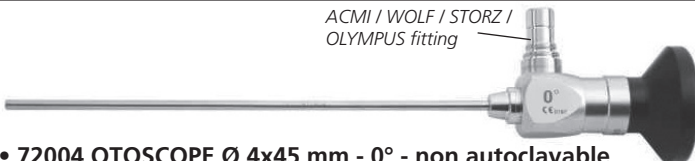

- 72004 OTOSCOPE Ø 4x45 mm - 0° - non autoclavable
- 72007 OTOSCOPE Ø 2.7x107.5 mm - 0° - non autoclavable
- 72008 OTOSCOPE Ø 2.7x107.5 mm - 30° - non autoclavable

## SINUSCOPIES

ACMI / WOLF / STORZ / OLYMPUS fitting



- 72010 SINUSCOPE Ø 4x175 mm - 0° - non autoclavable
- 72011 SINUSCOPE Ø 4x175 mm - 30° - non autoclavable
- 72012 SINUSCOPE Ø 4x175 mm - 70° - non autoclavable
- 72013 SINUSCOPE Ø 4x175 mm - 45° - non autoclavable

## LARYNGOSCOPE

ACMI / WOLF / STORZ / OLYMPUS fitting



- 72021 LARYNGOSCOPE Ø 8x170 mm - 70° - non autoclavable

## LIGHT SOURCE HANDLE



Connection to any endoscope with Storz fitting

- 30795 FLYER HALOGEN HANDLE 2.5 V - light source for endoscopes
  - 31478 BULB for 30795
  - 30794 FLYER LED HANDLE 2.5 V - light source
- Powerful handheld light source for endoscopes. 60,000 lux. Both flyer handles need 2xAAA batteries. Instructions: GB, FR, IT, ES, DE.

## Wi-Fi/USB CAMERA FOR ENDOSCOPES AND MICROSCOPES

- 32185 MICFIEYE - Wi-Fi/USB CAMERA (C-mount)
- 32186 C-MOUNT F18 ADAPTER FOR ENDOSCOPES
- 32187 MICROSCOPE ADAPTER Ø 23 mm

MICFIEYE is a Wi-Fi camera with C-mount and allows to digitalize the image on tablets, smartphones and PC using dedicated Apps and Softwares. MICFIEYE needs an adapter



32185+32187

32185+32186

Each camera is supplied with USB cable (1.2 m), USB AC adapter, user manual (GB, IT, FR, ES, DE), software can be downloaded free of charge from web

to be compatible with all optical devices such as microscopes, endoscopes, boroscopes, fiberscopes, C-mount lenses etc.

### TECHNICAL SPECIFICATIONS

Camera Type:	Colour CMOS camera
Sensor:	¼ Imax CMOS
Resolution:	1.3 MP
Image pixel:	320x240, 640x480, 1280x1024
Lens standard:	C-CS mount CCTV lens
Automatic optical features:	Gamma correction, exposure, white balance, black reference, flicker avoidance, defect identification, colour saturation
Button snapshot:	yes for Wi-Fi and USB mode
Dimension:	Ø 36x75 mm
Wi-Fi transmission distance:	≤5 m
Video resolution:	1.3 MP, 320x240, 640x480, 1280x1024
Frequency range:	2,400-24,835 GHz
Li-Ion battery:	Continuous working time - approx 2.5 hours
Power source:	5 V / 1A or USB (use only USB wall adaptors certified according the CE and/or FCC regulations)
OS support:	iOS / Android / Windows / Mac
Software features:	USB and Wi-Fi MIC-fi: snapshot*, video recording, calibration and measurement. Take time lapsed picture, (only USB Micfieye)

\*Only available with Wi-Fi mode

## GIMALED LIGHT SOURCE

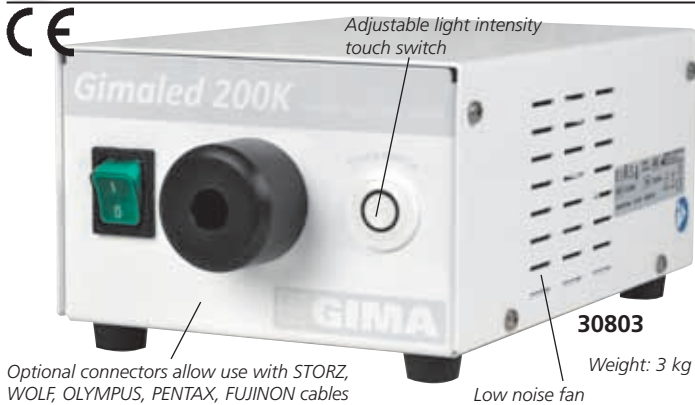

Optional connectors allow use with STORZ, WOLF, OLYMPUS, PENTAX, FUJINON cables

• **30803 GIMALED 200 K LIGHT SOURCE - 16 LED**  
Compact, lightweight, powerful light source for endoscopic use. A low noise fan provides the necessary cooling inside the metallic structure of the light source. Touch switch enables a variable light intensity. User manual in GB, ES, FR, IT, PT.

GIMA code	CONNECTORS FOR GIMALED LIGHT SOURCE TO DIFFERENT CABLES
30810	STORZ cable connector
30811	WOLF cable connector
30812	OLYMPUS cable connector
30815	PENTAX cable connector
30816	FUJINON cable connector

MADE IN ITALY

### TECHNICAL SPECIFICATIONS

Input for: GIMA, SCHOLLY and LUT cables Power supply: 100-240V, 50/60 Hz  
Illumination at 2.5 cm: 147,000 Lux ± 10 % LED life: 60,000 hours  
Colour temperature: 5000 K ± 5% Dimension: 27x17x h 11 cm  
CRI (Colour Rendering Index): 89 Ra Norms: IEC 60601-1, IEC 60601-2-18 Class II  
Max power absorption: 34 VA

## LED LIGHT SOURCE

• **27544 LED LIGHT SOURCE** 27544 Size: 30x25x12 cm  
Cold white light (5,500 °K, 200 lumen) for endoscopy use. It can be connected to endoscopes without need of F.O. cable. Handle connect directly to rigid endoscopes (Storz connection). 3 Watt power LED.

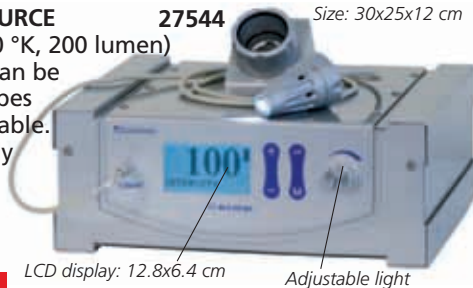

## F. O. HEAD LIGHTS

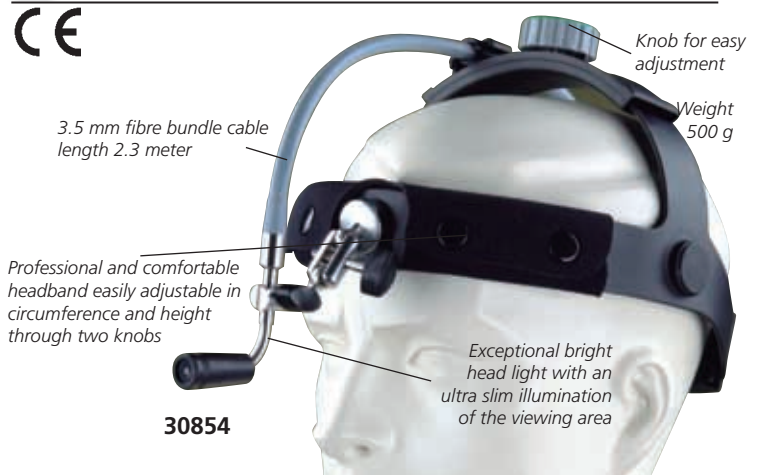

• **30853 WIDA FIBRE OPTIC HEAD LIGHT with F.O. cable**  
• **30854 WIDA PLUS FIBRE OPTIC HEAD LIGHT with F.O. cable**  
WIDA illumination systems are available in two versions: with professional and ergonomic headband but different focus. Both include F.O. cable with adaptor (30830) for connection to GIMALED light source (30803).  
Find below connectors to other light sources. Light beam can be focused through a focusing ring. Easy headband cleaning by removable and washable padding  
Multilingual manual: GB, FR, IT, ES  
• **30852 FOCUS DEVICE for 30850 (since lot 14 - May 2012), 30853**  
It reduces light in a very luminous spot Ø 10 mm.

### Diameter focus:

DISTANCE	30853	30854
20 cm	7-14 cm	5-8 cm
30 cm	10-19 cm	7-12 cm
50 cm	11.5-25 cm	12-20 cm

An exceptionally bright headlight with an illumination head for coaxial, shadow-free illumination of the viewing area.



## SURGICAL FIBRE OPTIC LIGHT CABLES AND ADAPTORS

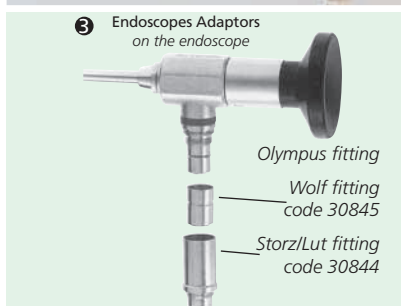
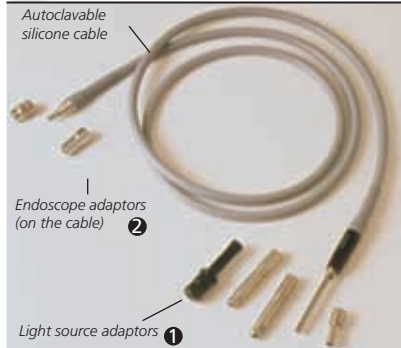

### 1 LIGHT SOURCE ADAPTORS to connect GIMA F.O. cables to light sources

- 30830 GIMA light source adaptor
- 30831 STORZ - AESCULAP-MARTIN light source adaptor
- 30832 WOLF - HENKE SASS - DYONICS - MEDICON - COMEG light source adaptor
- 30833 OLYMPUS light source ad.
- 30834 ACMI light source adaptor
- 30835 HEINE light source adaptor
- 30836 FUJINON light source adaptor
- 30837 PENTAX light source adaptor

### 2 ENDOSCOPE ADAPTORS - on the cables to connect endoscopes to GIMA F.O. cables

- 30840 ENDO STORZ adaptor
- 30841 ENDO WOLF adaptor
- 30842 ENDO ACMI, OLYMPUS-STRYKER adaptor

- 30817 FIBRE OPTIC CABLE 3.5 x 1,800 mm
- 30818 FIBRE OPTIC CABLE 4.8 x 1,800 mm
- 30822 FIBRE OPTIC CABLE 3.5 x 2,300 mm
- 30823 FIBRE OPTIC CABLE 4.8 x 2,300 mm
- 30826 FIBRE OPTIC CABLE 4.8 x 3,000 mm

High transmission surgical light cables, armoured but highly flexible with unique features:

- no burn outs
- strain relieved and protected by **silicone hose**
- **steam autoclavable** with warranty (12 months)
- light source end temperature resistant up to 134°C
- no electrical interferences with endoscopic surgery units
- kink resistant
- surgical stainless steel end fittings resist wear and corrosion
- stainless steel adaptors enables our cables to be used with other manufacturers halogen light sources/instruments

### 3 29975 FIBRE OPTIC CLAMP

- ENDOSCOPE ADAPTORS - on the endoscope to connect endoscopes to GIMA F.O. cables
- 30844 STORZ/LUT ENDOSCOPE ADAPTORS
  - 30845 WOLF ENDOSCOPE ADAPTORS

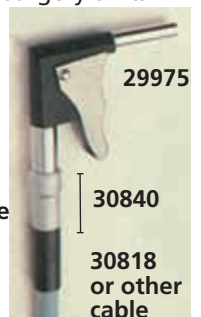

# GIMA ENT HEAD MIRRORS - BATTERY OR AC/DC TRANSFORMER USE

Simple adjustment of the band using rotating knob to fit any head size



31110

Comfortable, padded headband easy to remove for cleaning



31111

Head mirror Lux-100 with plug in transformer

## HEAD MIRRORS WITH TRANSFORMER

Supplied with plug-in transformer for direct power

Storz type head mirror

Silver coated mirror produces extremely bright light

Simple adjustment of the band using rotating knob



31108

Comfortable, padded head band easy to remove for cleaning



31109

On/off switch on battery

Supplied with headband mounted CR-123A battery box for 2x3 V batteries (not included)

Silver coated mirror produces extremely bright light

## HEAD MIRRORS WITH BATTERY

Extension cable

Clar type head mirror

## LUX-100 AVAILABLE WITH LED LIGHT

Quality head mirrors Ø 55 or 100 mm to perfectly illuminate the examination area in every situation. Long life 6 V lamp provides bright and natural light, quality silver coated mirror allows optimum light reflection. Mirror and light beam can be easily and precisely adjusted. Supplied with multilingual manual: GB, FR, IT, ES, PT, DE, GR, Arabic.

STANDARD ACCESSORIES	LUX AC/DC TRANSFORMER 31110-31111	LUX BATTERY* 31107-31109 31112
Mirror with head band	•	•
Long life bulb	•	•
Head band mounted battery case** for 2 x 3V CR-123A	•	•
Plug in transformer* 100/240 V - 50/60 Hz with cable	•	•
Pocket battery case	•	•
Sturdy plastic case	•	•
Cordura bag	•	•
Extension cable 80 cm and on/off switch 30 cm cable	•	•

\*Supplied with interchangeable UK, US, EU plugs

\*\*Battery not included

GIMA code	LUX ENT MIRRORS
31108	LUX-55 battery*** head mirror - Ø 55 mm - 6 V
31109	LUX-100 battery*** head mirror - Ø 100 mm - 6 V
31107	LUX-100 battery*** LED head mirror - Ø 100 mm - 6 V
31110	LUX-55 AC/DC transformer head mirror - Ø 55 mm - 6 V
31111	LUX-100 AC/DC transformer head mirror - Ø 100 mm - 6 V
31114	Mirror for LUX-55 - spare
31115	Mirror for LUX-100 - spare
31116	Bulb for LUX mirrors 6V Vacuum type - spare
31119	Carrying bag for LUX mirrors - black
31117	Battery case for LUX mirror 31112/3 - spare
31124	Connecting cable 30 cm for 31107-9 - spare
31118	Plug in transformer* 100-220 V - 50/60 Hz with cable - spare for 31110-1 - optional for 31108-31109

\*\*\*Battery mounted on head mirror band

## 2 LED HEADBAND MAGNIFIER

• 31168 2LED TWO-WAY REGULATION HEAD-WEARING MAGNIFIER with 5 lenses

Two-way regulation to adjust magnifier. Provided with 5 lenses 1.0x, 1.5x, 2.0x, 2.5x, 3.5x, which combined in group of two, ensure 11 different bigger magnifications and wider applications. For example, with lenses 1.0X and 2.5X magnification is 3.5X. Headband is made of PVC leather. It works with batteries, not included. Multilingual manual: GB, FR, IT, ES, PT, DE, SE, GR.



31168

## MAGNIFYING GLASSES

• 30848 SMART MAGNIFYING GLASSES 2.5X

Spectacle frame with magnifying glasses allows the physician to have a magnified view of the visual field. Lightweight, it folds up and can be worn over spectacles. 2.5X zoom lens can be tilted to achieve optimum focus.



30848

## 4 W LED HEADLIGHT

• 30849 H2O PRO LED HEADLIGHT

Compact and lightweight headlight with super bright Samsung 4W cool white LED.

Features:

Luminous intensity: high 350 lumen / low 30 lumen.

Range: 100 m high / 33 m low.

3 meters drop test, MCU control push switch (High/Low/Off).

PC material body with over-mould rubber head for maximum durability, 115° pivoting head.

Eye Risk Group 2, IP67 Dust proof and water proof, pass IK08 Impact.

10,000 switch cycle life, passed extreme temperature shock test.

Run time: high 3 hours, low 23 hours. 3xAAA battery included

• 32200 "AAA" ALKALINE BATTERIES - blister of 4 pcs - spare



30849

Size: 68x47x36.5 mm  
Weight: 75 g

## GIMA LED HEADLIGHT



- 30939 GIMA LED HEADLIGHT
- 30941 BATTERY PACK for 30939, 30940 and 30890\* - spare  
*\*Old Gima Led light need adaptor 30942 - light blue*
- 30943 CORD BATTERY - HEADLIGHT - spare
- 30942 ADAPTOR FOR BATTERY PACK\*\*

\*\*Only for use of battery pack (30941) with old Gima head light (30890)  
Led lamp without the heat of traditional halogen headlight. With a colour temperature of 5,000 °Kelvin, it provides bright, white, shadow-free light allowing the doctor to see tissue characteristics without distortion. Flexibility of operation using the rechargeable lithium battery, instead of direct power source. Comfortable lightweight headlights suitable for all kinds of surgery, ENT or dental applications. It can also be used while charging. Low-battery indicator light. Adapts to GIMA binocular loupes (codes 30892-8, 30910-5). Smart design, convenient for mobile diagnosis. Supplied in aluminium case with rechargeable 7.4 V / 4,400 mAH lithium battery and charger.  
Manual: GB, FR, IT, ES, DE, PT, GR, Arabic.



Adjustable light spot at 420 mm with iris diaphragm: 20-80 mm

75,000 LUX at 200 mm  
5,000° KELVIN

7 hours continuous run-time on a fully charged battery

Adjustable light intensity

### TECHNICAL SPECIFICATIONS

Adjustable illumination light spot at 420 mm: 20-80 mm  
Illumination at 200 mm working distance: ≥ 75,000 lux  
Fluctuation distance: 12.5 mm  
Angle range: vertical ± 25° adjustable  
Weight of headlight (excluding head band): 69 g  
Illumination source: extremely bright light, 5 W LED, life 20,000 hours  
Battery: 7.4 V/4,400mAH lithium battery  
Battery run-time: 7 hours continuous if fully charged battery (charging time: 5 h)  
Voltage: 100-240 VAC, 50-60 Hz  
Maximum input power: 30 W  
Power adapter output: DC 12 ±0.5 V, 1.5 A  
Electrical safety standard: EN60601-1, EN60601-2, Class II type BF

## SURGICAL LED HEADLIGHT

- 30936 GIMA 40 KL SURGICAL LED HEADLIGHT  
Latest generation of portable headlight system offering high quality performance. Features:  
- spot size adjustable by inner mini light grating  
- precise light imaging by multi optical lens  
- integrated cordless design  
Supplied with battery and battery charger.  
Multilingual manual: GB, FR, IT, ES, PT, DE, PL, GR.
- 30937 LITHIUM BATTERY 5W - spare

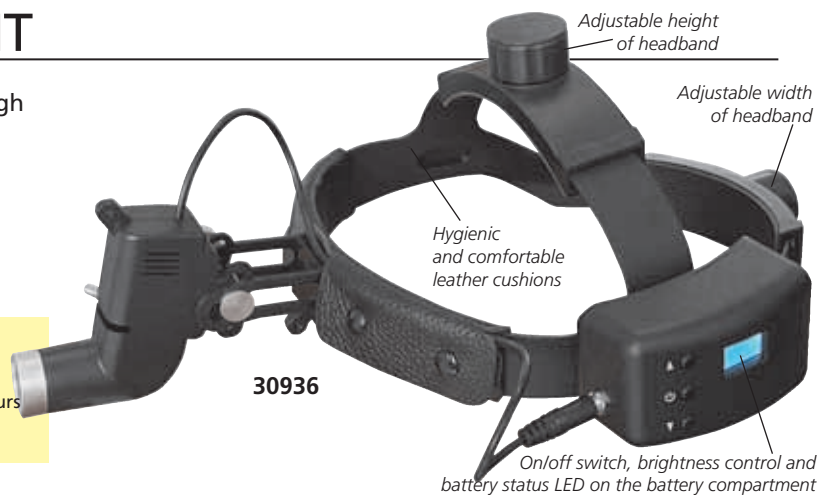

Adjustable height of headband

Adjustable width of headband

Hygienic and comfortable leather cushions

30936

On/off switch, brightness control and battery status LED on the battery compartment

### TECHNICAL SPECIFICATIONS

Illumination source: 5W LED  
Illumination intensity: 10-40,000 lux  
Colour temperature: 6,000K  
Spot size: Max 70 mm, Min 50 mm at 32 cm  
Lamp working life: 50,000 hours  
Battery: 3.7V Lithium Battery  
Battery run time: 5-12 hours  
Battery charging time: 3.6 hours  
Input voltage: 100-240VAC  
Weight: 200 g

## GIMA BINOCULAR LOUPES

**BINOCULAR LOUPES:**  
Lightweight, ergonomically superior Galilean-style flip-up loupes. Can be used independently or mounted on 30890, 30940. Multi-coated and high grade glass lenses provide clean and sharp image. Eyepiece with wide field of view. Deep focus to see object stereoscopically. Loupes angles can be easily adjusted between 0° and 40° to minimize fatigue even after prolonged use. 6 mm up and down displacement. Adjustable pupil distance to fit different face types.

**STYLE BINOCULAR LOUPES:**  
Line of binocular loupes with same features of traditional line but mounted on a extra light, fashionable frame.



Weight: 103 g



All binocular loupes have multilingual manual: GB, FR, IT, ES, PT, GR.

30897

All binocular loupes are supplied in a case

30910

Weight: 111 g

GIMA code	BINOCULAR LOUPES	Magnification	Working distance	Field of view Ø
30892	Binocular Loupe	2.5X	340 mm	80 mm
30894	Binocular Loupe	2.5X	420 mm	90 mm
30897	Binocular Loupe	3.5X	340 mm	50 mm
30898	Binocular Loupe	3.5X	420 mm	60 mm

GIMA code	STYLE BINOCULAR LOUPES	Magnification	Working distance	Field of view Ø
30910	Style binocular Loupe	2.5X	340 mm	80 mm
30911	Style binocular Loupe	2.5X	420 mm	90 mm
30914	Style binocular Loupe	3.5X	340 mm	50 mm
30915	Style binocular Loupe	3.5X	420 mm	60 mm

## HEINE LED HEAD LIGHT



90,000 LUX at 180 mm

5 YEARS WARRANTY

30884

Rechargeable battery pack and direct mains transformer included.

POWERFUL LED ILLUMINATION

- **30884 HEINE ML4 LED<sup>HQ</sup> HEAD LIGHT - J.008.31.413**
- LED in HQ; defining optimal light intensity (90,000 lux at 180 mm), brightness and homogeneity from edge to edge, and colour rendering (4,500 k, CRI >90, R9 >75). This ensures true colour tissue for the most accurate diagnosis.
- **Coaxial illumination:** ensures a completely shadow-free image and allows for excellent illumination of difficult to see areas
- **Lithium Battery:** for up to 8.5 hours of continuous working
- **LED Thermal Management:** guarantees consistent quality and performance throughout the LED's lifetime (50,000 hours)
- **Adjustable illumination spot size:** 30 to 80 mm spot size range (at 420 mm working distance) to fit any examination situation
- **Comfortable and secure fit:** multiple adjustment points and soft padding for comfort and stability even during long procedures
- **Illumination Intensity Control:** for precise brightness setting
- **30886 HEINE BINOCULAR LOUPE 2.5X-340 mm - J.000.31.370**
- **30887 HEINE BINOCULAR LOUPE 2.5X-420 mm - J.000.31.371**
- **30888 P2 POLARIZATION FILTER FOR ML4 AND 2.5X LOUPES - J.000.31.326**



### TECHNICAL SPECIFICATIONS

Power supply:	mPack® Rechargeable Battery Pack with Li-ion battery and direct mains transformer
Illumination:	90,000 lux at a working distance of 180 mm
LED operating life:	50,000 hours
Spot adjustment:	30 mm to 80 mm illuminated field diameter (at 420 mm)
Colour temperature:	5,500°K

## HEINE BINOCULAR LOUPES



Only 42 g

30930, 30931



Eyepieces individually adjustable

2.5 X loupes

### HEINE® S-FRAME® WITH BINOCULAR LOUPES

- **Achromatic optics:** crisp, bright image with colour-correction.
- **Multi-coated, scratch-resistant silica glass lenses** - produce crisp, clear images. **High magnification with a large field of view and excellent depth of field.**
- **Water resistant**
- **Flexibility for precise adjustment:** independently adjustable Pupillary Distance controls ensure precise alignment of the optics, for a stereoscopy view.
- **i-View loupe mount;** provides any angle of view and the possibility flips up and down the optics to exclude or re-include the magnification during any procedure.
- **Different magnification and working distance.**

GIMA code	BINOCULAR LOUPES	Magnification	Working distance	HEINE code
30930	Heine binocular loupes	2.5X	340 mm	C-000.32.355
30931	Heine binocular loupes	2.5X	420 mm	C-000.32.356
30932	Heine binocular loupes	4X	340 mm	C-000.32.431

- **30888 P2 POLARIZATION FILTER FOR ML4 AND 2.5X LOUPES - J.000.31.326**



Set content: optics, S-frame with i-View loupe mount, detachable protective lenses, 2 sterilizable swivel levers, retaining cord, cleaning fluid, carrying case.

## RIESTER RI-FOCUS LED HEADLIGHT

- **30881 RI-FOCUS 6091 LED HEADLIGHT** - with rechargeable batteries
  - High performance LED headlight with battery compartment for fast and easy change of battery. Flexible hinge for a comfortable one-hand use of the LED illumination body.
  - more efficient diagnosis due to white and high performance LED with up to 100,000 LUX and 50,000 hours lifetime
  - wireless headband with built-in battery compartment
  - particularly comfortable with balanced headband and one-hand operation
  - focusable LED lamp at a distance of 40 cm approx Ø 40 mm to 200 mm infinitely focusable
  - white LED with 6,000 °Kelvin, 140 lumen
  - significantly less heating and energy loss
  - rechargeable battery operation: approx 90 min with fully charged batteries
- Rechargeable AAA batteries and plug in 100-240 V charger included.

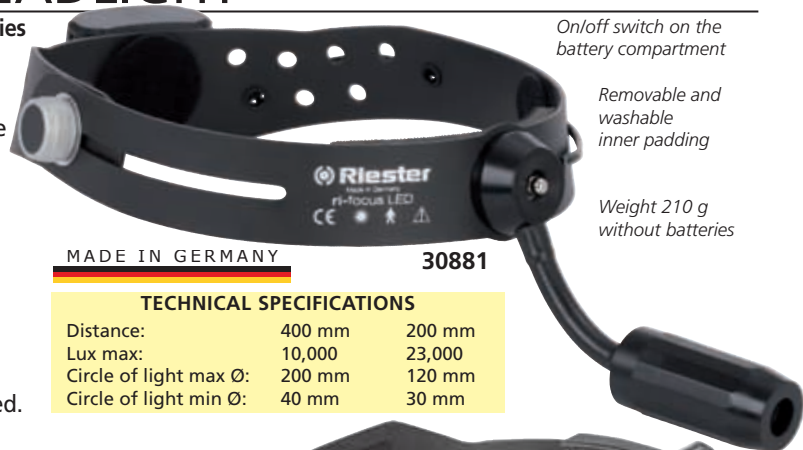

On/off switch on the battery compartment

Removable and washable inner padding

Weight 210 g without batteries

MADE IN GERMANY

30881

### TECHNICAL SPECIFICATIONS

Distance:	400 mm	200 mm
Lux max:	10,000	23,000
Circle of light max Ø:	200 mm	120 mm
Circle of light min Ø:	40 mm	30 mm

## GIMA LED MEDICAL HEADLIGHT

- **30879 GIMA 38 KL LED MEDICAL HEADLIGHT 3W**
- with rechargeable batteries
- Advanced LED technology headlight with white and homogeneous light, ideal for all surgical and dental applications
- brilliant LED micro 3W provides free range of movement and wide field of view
- **coaxial illumination,** shadow-free illumination of cavities, ideal for ENT and dental applications.
- compact, lightweight, ensures perfect comfort
- compact and long lasting aluminium housing, reduces heat build-up. Easy to clean.
- individual adjustment of the angle of view.
- **30878 LITHIUM BATTERY 3W - spare**

Multilingual manual: GB, FR, IT, ES, PT, DE, PL, GR.



On/off switch, brightness control and battery status LED on the battery compartment

Supplied with battery and battery charger

30879

### TECHNICAL SPECIFICATIONS

Illumination:	38,000 lux	Brightness intensity: 0-100% adjustable
Light spot:	80 mm at 50 cm	Battery duration: 5-12 hours
	50 mm at 32 cm	Battery charging time: 3.6 hours
LED operating life:	up to 50,000 hours	Battery charger: 100-240 V, 50/60 Hz

# PENTALED 63N THEATRE LIGHTS

## PENTALED 63N

PentaLED 63N is a high-tech product designed to guarantee excellent performance levels. PENTALED 63N has 72 elliptical reflectors split into 8 modules, each containing 9 LEDs. The modules are mechanically focused by rotating the sterilizable handle. The multiplicity of the luminous sources and the elliptical geometry of the parabolas studied to reflect in the depth the light beams generated by the LEDs, grant scalytic light for a three-dimensional illumination without shadows.

**63N 160,000 LUX**

MADE IN ITALY

### Comfortable use

Thanks to the principle of indirect light, the lamp oriented towards different positions does not dazzle the surgeon and the assistants. The size of the lit field is adjusted mechanically through handle according to the light required by the surgeon.



### Superior lighting features

Membrane keyboard activates the following functions:

- selection of the colour temperature 5,000°K and 4,500°K
- adjustment of the light intensity up to 160 Klx
- on/off
- endo light with colour selection (comfortable light for endoscopy intervention)

The colour temperature of 5,000°K stimulates the surgeons' concentration, does not strain their sight, reproduces the colour of the tissues faithfully and increases the definition of the edges.

### Reliable and long lasting performances

The modular construction of the electronic board that feeds the LEDs guarantees continuous light, even in the unlikely event that a LED or board component should fail. The lighting body is protected by tempered glass screen, covered by a special film avoiding any fallen down splinters in case of break.

### Easy manoeuvrability

The reduced dimensions and the light reflector provide extreme manoeuvrability and stability. Smooth 360° rotation. The extremely light structure, the aluminium treated bar attached to the upper front of the cupola, the ultra-thin dome (only 13 cm) allow simple movements.

### Battery group, TVCC camera, monitor holding arm on request

Every lamp can be supplied with an emergency battery group with automatic charger (hours autonomy: 1.5 (49200), 1.5 for 63N, 4 for 30N 1.5 (49202)), TVCC camera or monitor holding arm.

### Full certification

Complies with regulation EU2017/745 'Class I - Medical Device'. QR manual: GB, FR, IT, ES, PT.

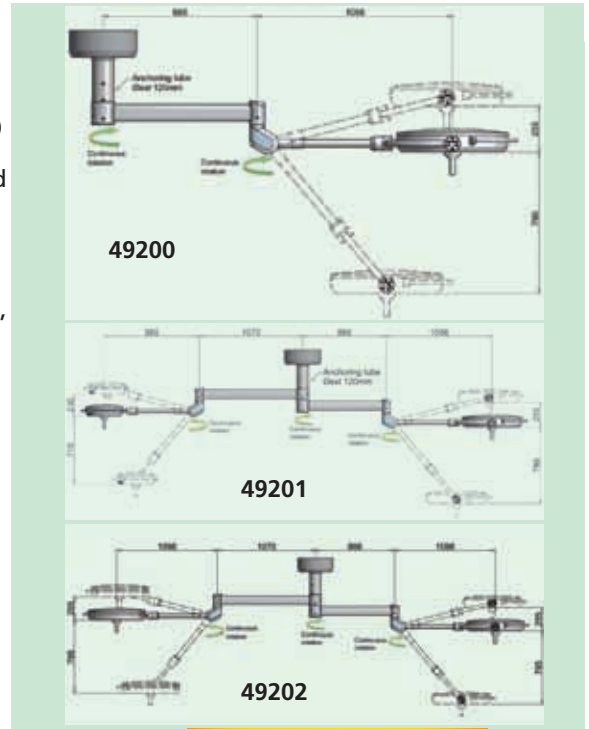

GIMA code	PENTALED 63N THEATRE LIGHTS - CEILING*
49200	PENTALED 63N* - 160,000 LUX
49201	PENTALED 63N+30N double** - 320,000 LUX - compact
49202	PENTALED 63N+63N double** - 320,000 LUX - plus
*Ceiling >3.41 m needs 49220 **Ceiling >3.53 m needs 49220	
ACCESSORIES	
30738	Autoclavable handle - spare
49205	Monitor holding arm - stand alone
49206	IR remote control - single lamps
49207	IR remote control - double lamp
ACCESSORIES TO BE ORDERED WITH LIGHT	
49210	Battery group with automatic charger for 63N
49211	Battery group with automatic charger for 63N+30N
49212	Battery group with automatic charger for 63N+63N
49214	HD TVCC camera for 63N - including lamp setup
49215	Monitor holding arm - integrated with lamp
49220	Special structure for high ceiling

TECHNICAL SPECIFICATIONS			
		63N	30N
Performance	Light intensity at 1 m distance (Ec)	klx 160	160
	Colour temperature: double selection	°K 4,500/5,000	4,500/5,000
	Colour rendering index (CRI)	Ra 96	96
	Light field diameter adjustable from/to	cm 16-30	14-28
	Total radiated energy Ee where the illumination reaches max level	W/m <sup>2</sup> 580	580
	Number of LED	72	30
	Diameter and focus adjustment	manual	manual
	Depth of illumination IEC 60601-0-41 L1+L2 at 60%	cm 56	65
	Depth of illumination IEC 60601-0-41 L1+L2 at 20%	cm 108	115
	Control of illuminance	% 20-100	20-100
Electrical data	Endo LED light intensity min-max	klx 5-20	9-25
	Operating power (VAC)	V 100-240	100-240
	Operating power Vdc	V 24	24
	Electrical absorbed power	VA 67	60
General data	Frequency	Hz 50/60	50/60
	Average LED life	h 60,000	60,000
	Colour	RAL 9003	9003
	Minimum height of the room	cm 260	260
	Outer reflector diameter	cm 63	40
	Useful lighting surface	cm <sup>2</sup> 1828	762
Weight	kg 47	39	



**63N+30N 320,000 LUX (160,000+160,000 LUX)**



Shadowless compact

**63N+63N 320,000 LUX (160,000+160,000 LUX)**



Shadowless plus



## GIMALED O.T. LED LIGHTS - 160,000 LUX

GimaLed light with **81 LEDs**: sophisticated design which combines excellent lighting features with exceptional mechanical characteristics for extra soft movement.

**Deep light**: 27 inner fixed Leds for central illumination and 54 LEDs (six modules of nine LEDs each) moved by servo-motor, allow surgeon to adjust light field diameter.

**Shadowless light**: 81 LEDs arranged on a round surface grant the best light emitting surface and avoid any shadow effect caused by any interposition between light beams and lighted surface.

**Bright light**: two colour selections, 4,000K and 4,600K, made of white LEDs only, no coloured shadow effect.

### Major features

- collimated light beams for a working distance from 70 to 160 cm
- high colour rendering index (CRI) 95, R9 >90
- optimisation of LED thermal management by heat dissipation convection to avoid illuminance reduction during surgery
- PMMA optical lenses and polycarbonate protective screen
- Zener to grant light in case of even one LED failure
- reduced consumption, high efficiency

Electronic control of light adjustment, colour temperature, light field diameter and endoscopy light.

GIMA code	GIMALED
49180	GimaLed-mobile - 160,000 Lux
49181	GimaLed-mobile with battery group and automatic charger
49182	GimaLed - ceiling* - 160,000 Lux
49183	GimaLed - ceiling** - double - 320,000 Lux
49197	Autoclavable handle
49205	Monitor holding arm - stand alone
49220	Special structure for high ceiling
49185	GimaLed wall remote control

Battery group available on request for all models

\*Ceiling >3.41 m needs 49220      \*\*Ceiling >3.53 m needs 49220

Small overall dimensions of cupola, perfectly balanced, ensure stable adjustment.

Ergonomic grip on the cupola and on the protective screen to hold and move the lamp

Motorised light field diameter adjustment through touch sensitive sterilisable handle or touch pad at the side of the cupola

49183

Thin and easy-to-adjust reflector

160,000 LUX

MADE IN ITALY

49180

### TECHNICAL SPECIFICATIONS

Light intensity at 1 m distance (Ec)	Klx 160, Klx 320 (only 49183)
2 Colour temperature - switchable	*K 4,000 and 4,600
Colour rendering index (CRI)	Ra 95
Light field Ø (adjustable)	11-35 cm
Light field Ø where illuminance reaches 10% of Ec (d10)	260 mm
Light field Ø where illuminance reaches 50% of Ec	150 mm
Total radiated energy Ee where illumination reaches max level	556 W/m <sup>2</sup>
Average LED life	hours 60,000
Power supply:	100-240 V - 50-60 Hz - 61-71 W
Regulations:	IEC 60601-2-41 - EU 2017/745

## PENTALED 30E SURGERY LAMP 160,000 LUX

### LED LIGHT INNOVATIVE TECHNOLOGY

A compact size hi-tech product that guarantees great performance levels. It has 30 elliptical reflectors split into 6 modules each containing 5 LEDs, providing 160,000 LUX - **selectable 4,500 °K - 5,000 °K**. By simply pressing the digital key, the surgeon can choose two different white light temperatures

- **E-view** innovative lens allows the surgeon to expand/narrow the illuminated operating field electronically, without altering intensity of light.

- **E-comfort** the indirect LEDs creates 3D shadowless illumination of the operating field, no risk of dazzling

- **E-white** only white LEDs to avoid risk of perception of colour temperature variations or coloured shadows

- **E-deep** centre of light is fitted with extra LEDs module specifically designed to reflect deep light. This means that surgeon can work with perfect 3D lighting.

**Battery and high definition camera on request.** Optional battery group with automatic charger (4 hours autonomy) and high definition integrated camera (for ceiling and wall models only).

GIMA code	PENTALED 30E
30780	Pentaled-mobile - 160,000 Lux
30779	Pentaled-mobile with battery group and automatic charger
30781	Pentaled - wall - 160,000 Lux
30782	Pentaled - ceiling* - 160,000 Lux
30783	Pentaled - ceiling** - double - 320,000 Lux
30785	Autoclavable handle - up to serial number 12071
30738	Autoclavable handle - since serial number 12072
49205	Monitor holding arm - stand alone
49220	Special structure for high ceiling (>3.8 m)

Battery group available on request for all models

\*Ceiling >3.41 m needs 49220      \*\*Ceiling >3.53 m needs 49220

An aluminium ring runs around the dome for easier positioning

QR manual: GB, FR, IT, ES, PT.

Aluminium structure tested for over 40,000 movements

RIMSA

MADE IN ITALY

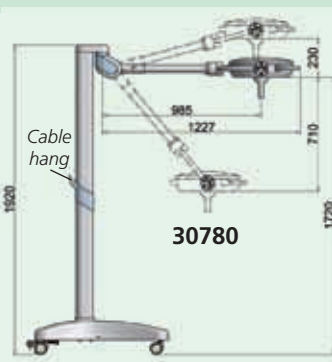

30780

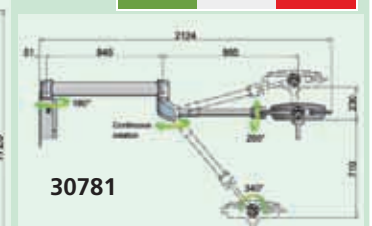

30781

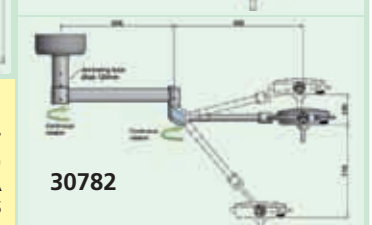

30782

### TECHNICAL SPECIFICATIONS

Adjustable light intensity at 1 m distance (Ec)	Klx 160	Total radiated energy Ee where illumination reaches max level	W/m <sup>2</sup> 627
Colour temperature - switchable	*K 4,500 to 5,000	Average LED life	hours 60,000
Colour rendering index (CRI)	Ra 96	Power supply:	100-240 V - 50-60 Hz - 60 VA
Light field (electronically adjustable)	14-26 cm	Regulations:	IEC 60601-2-41 - EU 2017/745
Light field Ø where illuminance reaches 10% of Ec (d10)	mm 210		
Light field Ø where illuminance reaches 50% of Ec	mm 80		

# QUATTROLUCI LED LIGHTS - 160,000 LUX

## QUATTROLUCI LED LIGHTS - 4 DOMES WITH 9 LEDS EACH

Aerodynamic design, extremely handy structure, high technology, quality and performance in one lamp. The multi-circular reflector, designed to light up the work area thoroughly and suppress all the shadows, is equipped with central handle to facilitate positioning. Ultra-flat lighting body is equipped with ultra-resistant polycarbonate screen, which guarantees protection against possible accidental collisions. Its rotation on 4 axes facilitates positioning. The dome consists of 36 LED lenses arranged radial fashion on 4 module of 9 LED each, to ensure light continuity even in the rare case of individual LED fault. Light intensity is 160,000 lux. Excellent for oral and maxillofacial surgery and aesthetic plastic surgery.

### TECHNICAL SPECIFICATIONS

Light intensity:	160,000 lux at 1 m distance
Colour temperature:	4,900° K
36 LEDs average LED life:	>60,000 hours
CRI (Chromatic Rendering Index):	94
Diameter of the reflector:	60 cm
Diameter of illuminated field:	30 cm
Depth of illumination IEC 60601-2-41 (L1+L2) at 20%:	174 cm
	110 cm
Total radiated energy:	Ee 570 W/m <sup>2</sup>
Weight (ceiling, mobile, wall) kg:	15, 23, 14
Min./Max. height of the room (ceiling version):	255-334* cm
Power supply:	100-240V - 50/60 Hz
Norms:	IEC 60601-1, IEC 60601-2-41 - EU 2017/745

GIMA code	QUATTROLUCI LED LIGHTS
49150	Quattroluci Led light - trolley
49151	Quattroluci led light - trolley with battery group and automatic charger
49152	Quattroluci Led light - wall
49153	Quattroluci Led light - ceiling*
49154	Quattroluci Led light double - ceiling**
30788	Special structure for high ceiling
30738	Spare autoclavable handle - for scalytic 3 bulbs
Battery group available on request for all models***	

\*Ceiling >3.34 m needs 30788 \*\*Ceiling >3.58 m needs 30788 \*\*\*To be ordered with light

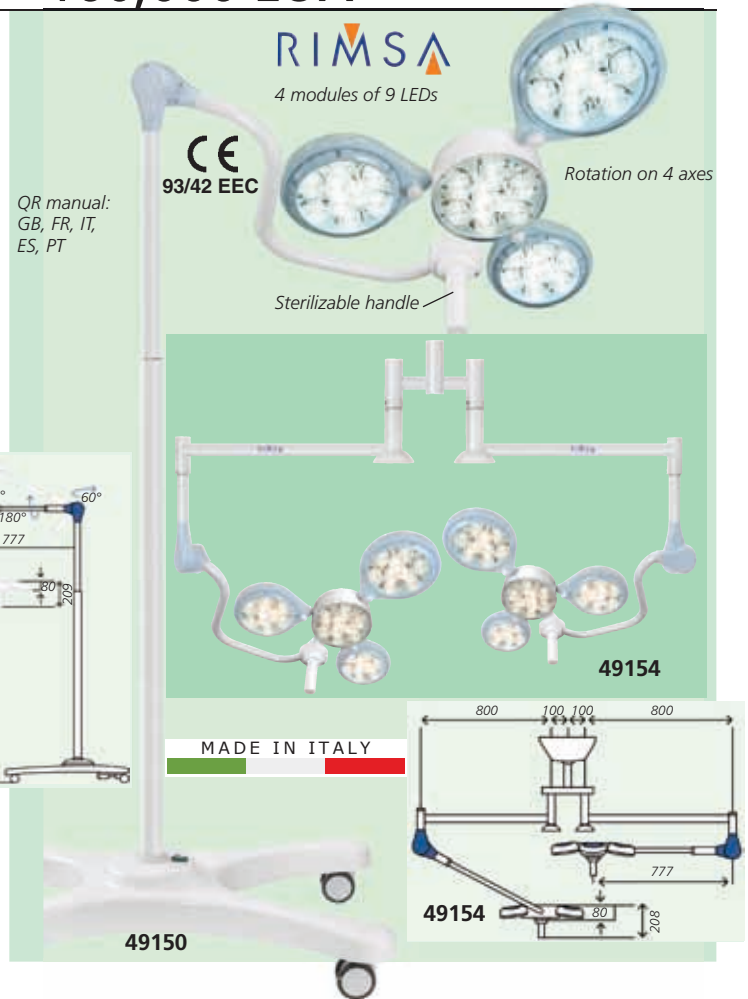

# SATURNO LED LIGHTS - 50,000 LUX

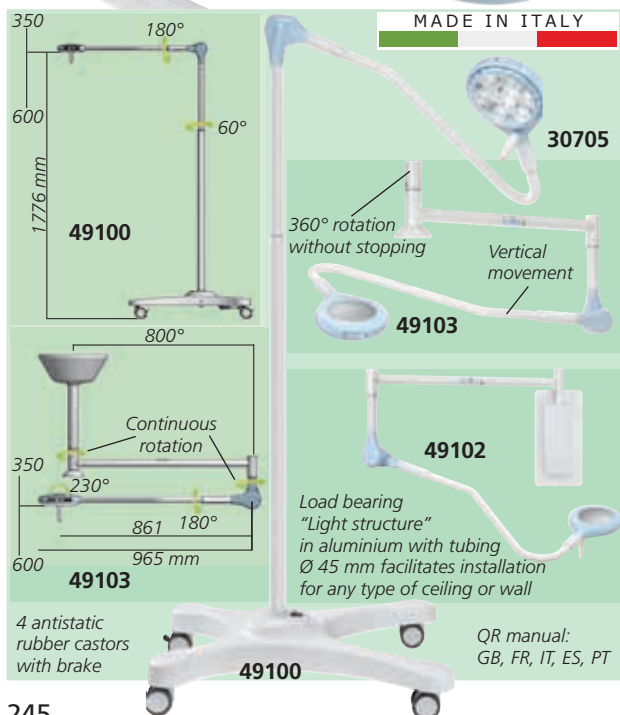

## SATURNO LED MINOR SURGERY LAMP

SATURNO is a shadow-less type lamp suitable for small surgery, gynaecology and examination. Available in three versions: mobile with castors, wall and ceiling.

- light beams are generated from 9 LEDs - 2.0 W each
- heat is dissipated through aluminium cover reflector
- selection of 2 different white light temperatures: 4,000 and 4,500 °K
- light intensity adjustable at 7 different levels through front digital panel
- luminous intensity 50,000 LUX at 1 m. Ø of illuminated field 28 cm
- adjustable friction bearing are mounted on every articulation of the lamp
- thanks to optical concept, no need to be focus adjusted

**Battery group with charger:** 4 hours autonomy, 6 hours recharging.

### TECHNICAL SPECIFICATIONS

Light intensity at 1 m distance	Lux	50,000
Colour temperature adjustable	K°	4,000/4,500 ± 5%
9 LEDs	W	2.0 each (18 total)
Average LED life	hours	60,000
CRI (chromatic rendering Index)	Ra	95
Diameter of illuminated field	Ø cm	28
Depth of illumination IEC 60601-2-41 (L1+L2) at 60% of Ec	cm	110
Total radiated energy Ec	W/m <sup>2</sup>	186
Diameter of the reflector	cm	19.5
Useful lighting surface of the cupola	cm <sup>2</sup>	63
Weight (ceiling, mobile, wall)	kg	12 - 20 - 11
Power requirements	V, Hz	100-240, 50-60
Minimum height of the room (ceiling version)	cm	254.5
Standards: IEC 60601-1 IEC 60601-2-41, EU 2017/745, medical device of Class I		

GIMA code	SATURNO LED LIGHTS
49100	Saturno LED light - mobile stand
49101	Saturno LED light - mobile stand with battery group
49102	Saturno LED light - wall
49103	Saturno LED light - ceiling* (2.54-3.34 m)
30788	Special structure for high ceiling (>3.34 m)
30797	Spare autoclavable handle for Saturno
Battery group with automatic charger available on request for all models (to be installed at order)	

\*Ceiling >3.34 m needs 30788

# PENTALED 12 - 100,000\* LUX, PENTALED 28 - 120,000 LUX

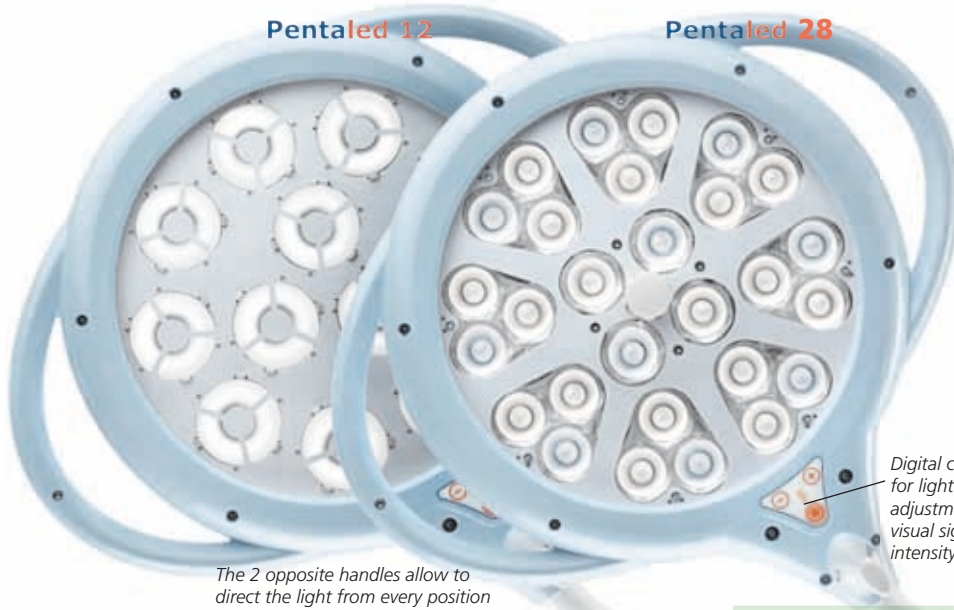

## PentaLED 12

- 100,000\* Lux at 1 m
- indirect light with 12 elliptic reflectors. They reflect the light rays emitted by the LEDs. Does not dazzle and does not strain eyes.

## PentaLED 28

- 120,000 Lux at 1 m
- direct light with 28 LED lens
- double colour selection: 4,500 or 5,000 K
- light field adjustment

MADE IN ITALY

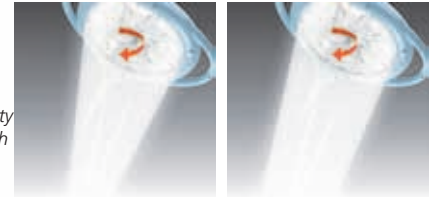

Digital control for light intensity adjustment with visual signal of intensity set up

Light field adjustment for PENTALED 28

The 2 opposite handles allow to direct the light from every position

### PENTALED

PENTALED is a perfect combination of technological developments, innovation, ergonomics and compact design, ultra-light and handy structure. Five versions available (trolley, ceiling, ceiling double, trolley with battery group and wall) and technical performances make PENTALED suitable for precision operations, diagnostic use, surgical rooms and small surgeries. Battery group, with an autonomy of 2 hours (PentaLED 12) or 1.5 hours (PentaLED 28), is available on request also for wall and ceiling models.

### Cold LED light

Bright and cold light reproduces colours faithfully, assuring excellent definition of details.

### Ergonomic

- PENTALED can be easily positioned by rotation on 4 axes:
- the dome has a 300° rotation
- the arm moves vertically thanks to a spring balancing system
- the reflector can be rotated on the vertical and horizontal axis.

### 60,000 hours life time

The low power supply current and the heat dispersion through aluminium dome allow the LED a 60,000 hours lifetime.

### Light intensity adjustment

Light intensity adjustable through digital control



The ultra-flat lighting body is equipped with ultra-resistant polycarbonate screen which guarantees protection against accidental collisions.



The dome can be adjusted by the sterilizable handle

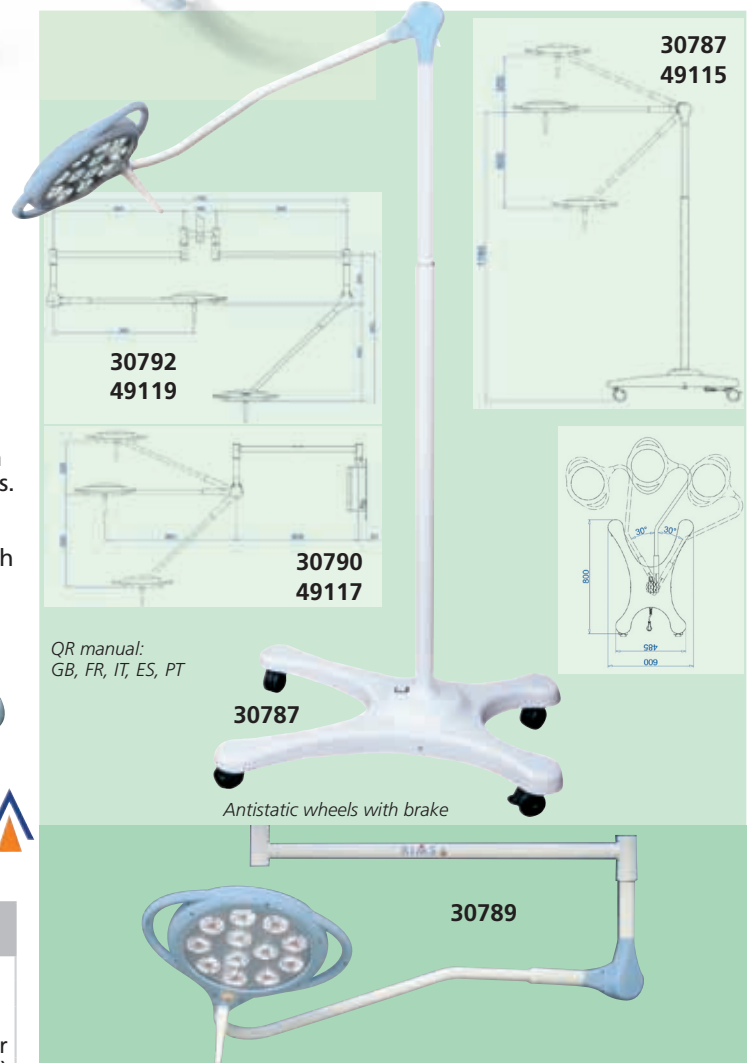

QR manual: GB, FR, IT, ES, PT

PENTALED 12 LEDS	
30787	PentaLED 12 - trolley
30789	PentaLED 12 - ceiling* (for ceiling 2.54 to 3.34 m)
30790	PentaLED 12 - wall
30791	PentaLED 12 - trolley with battery group and automatic charger
30792	PentaLED 12+12 - ceiling** double (for ceiling 2.66 to 3.56)
30788	Special structure for high ceiling
30793	Autoclavable handle - spare
PENTALED 28 LEDS	
49115	PentaLED 28 - trolley
49116	PentaLED 28 - ceiling* (for ceiling from 2.54 to 3.34 m)
49117	PentaLED 28 - wall
49118	PentaLED 28 - trolley with battery group and automatic charger
49119	PentaLED 28+28 - ceiling** double (for ceiling 2.66 to 3.56 m)
30788	Special structure for high ceiling
30793	Autoclavable handle - spare

\*Ceiling >3.34 m needs 30788 \*\*Ceiling >3.56 m needs 30788

	TECHNICAL SPECIFICATIONS	
	PENTALED 12	PENTALED 28
Light intensity at 1 m distance	Lux 100,000	120,000
Colour temperature	K° 4,500	4,500/5,000
LED	No. 12	28
Average LED life	hours 60,000	60,000
CRI (Chromatic rendering Index)	Ra 95	95
Diameter of illuminated field	Ø mm 160	135-270
Depth of illumination (L1+L2) at 60%	cm 75	92
Total radiated energy Ec	W/m² 370	456
Weight (ceiling, mobile, wall, double)	kg	13-21-12-20
Power supply	V/Hz	100-240V, 50-60Hz
Standards: IEC 60601-2-41, EU 2017/745, medical device of Class I		

## PRIMALED COLD LIGHT LAMP - 105,000 LUX AT 50 cm

### PRIMALED COLD LIGHT LAMP WITH 9 LED LENSES

Appealing design and advanced technology.

**Design:** the round and ultra-flat shape of the light makes the product ergonomic and suitable for any type of installation.

**Ergo-Spring:** the movement of the articulated tubular arm is servo-assisted by a torsion spring which ensures ease of movement and stability.

**105,000 lux:** unique performance with 105,000 lux at 50 cm.

**Light intensity adjustment:** six different adjustment levels by the keys on the frontal panel.

**4,000-4,500 °K Colour temperature selection:** the comparison between the two colours (K) increases the visibility of details.

**Shadow suppression:** the radial layout of the lenses and the large-diameter lamp (195 mm) allow shadow suppression and three-dimensional lighting.

**Adjustable courtesy-light:** integrates ambient light with traditional concentrated light.

**Sterilizable removable grip:** allows best asepsis.

**Cold light:** the reduced emission of IR rays by the LEDs as well as the low power consumption allow minimum heat emission.

**60,000 hours LEDs life:** the top aluminium dome allows heat exchange, thus reducing the work temperature and considerably increasing the life cycle of the single LEDs.

**Interchangeable plugs:** transformer is integrated in the plug for a lighter and smooth movement of the arm.

Supplied with interchangeable plugs (UK, US, EU).

**Fully certified:** complies with IEC 60601-1 and 60601-1-2 general medical standards and to special standard IEC 60601-2-41 EU 2017/745 and is CE marked as a Class I medical device.

**Mechanical testing and user safety:** die-cast aluminium and tubular steel structure. The articulated arm has undergone mechanical testing for 40,000 continuous movements.

**Light continuity:** the modular design of the LED power circuit ensures light continuity even in case of a LED fault.

**Battery kit:** included with 49124, available in 45 days for 49125 (to be purchased with light).

The lamp lens has been designed to provide focused and deep lighting. Lighted field diameter is 16 cm at 0,5 m.

The following functions are controlled by the keys on the membrane keyboard:

- on/off
- selection of the 4,000°K and 4,500°K colour temperatures
- 6-level adjustment of the light intensity
- courtesy light

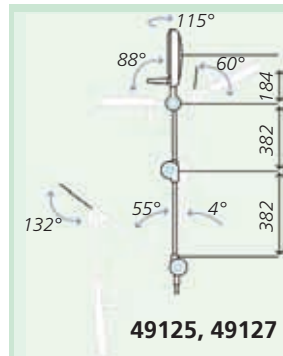

QR manual:  
GB, FR, IT, ES, PT

49125



FLEX ARM

49124,  
49126



FIX ARM

49125

Lithium battery,  
8 hours autonomy

GIMA code	PRIMALED FIX AND FLEX
49124	Primaled - flex light - trolley with battery
49125	Primaled - fix light - trolley
49126	Primaled - flex light - trolley
49127	Primaled - fix light - wall
49128	Primaled - flex light - wall
30797	Autoclavable handle
30769	Trolley - base Ø 61 cm - spare

#### TECHNICAL SPECIFICATIONS

LED life: >60,000 hours  
Light intensity: 105,000 lux at 50 cm, 30,000 lux at 1 m  
Colour temperature: 4,000-4,500 °K  
External diameter of the reflector: 195 mm  
Temperature increase in the operating area at 1 m: 1°C  
Adjustable height with castors: 600 mm - max 1,600 mm  
Power supply: 100-240V - 50/60 Hz  
Weight: 10 kg (trolley included)

Illuminated field at 50 cm: Ø 160 mm  
Illuminated field at 1 m: Ø 300 mm  
Colour rendering index: 95 Ra  
Colour temperature: 4,000-4,500 °K  
Electric absorption: 20VA  
Light intensity adjustment: 20-100%



49124,  
49125,  
49126

49127,  
49128

49124

Trolley base

Wall clamp

Rail clamp on request



## MS LED PLUS AND MS LED FLEX PLUS LIGHT - 65,000 LUX

• 49132 MS LED PLUS LIGHT - trolley

• 49133 MS LED FLEX PLUS LIGHT - trolley

Minor surgery luminaire with LED light source. Flexible or articulated arm with great precision allow regulation of the light in any position. High quality of materials makes it especially suitable for intensive use in surgery and examinations.

### Exceptional quality of LED light

Powerful LED light source offers exceptional light quality and a lifespan of more than 50,000 hours. The high performance of the colour Ra 97% depicts the exceptional quality of white light for an excellent distinction of fabrics and reproduction of all visible colours, naturally and precisely.

### Ergonomic design

The circular shape of the head and its handle in the lower part facilitate its exact positioning, clean and soft shapes which facilitate hygiene and cleanliness.

TECHNICAL SPECIFICATIONS		
Light source	LED 12W	Colour rendering > 97%
Lux at 50 centimeters	65,000 lux	Lamp lifetime 50.000 hours
Adjustable light intensity	Yes	Arm length 90 cm (49132)
Colour temperature	4.500 °K	70 cm (49133)
Colour	White	



49133

Dimmable,  
adjustable  
light intensity

MIMSAL

MADE IN SPAIN

49132

49133

# HALOGEN AND LED LIGHTS FOR EXAMINATION AND MINOR SURGERY

**60,000 LUX WITH 3 LEDS**



**RIMSA**

30726,  
30727,  
30728

Ergonomic handle

**60,000 LUX WITH 3 LEDS**



Touch button

**RIMSA**

30723,  
30724,  
30725

Manual in:  
GB, FR, IT, DE, ES, PT

**50,000 LUX - Halogen  
15,000 LUX - LED**



**MIMSAL**

30754

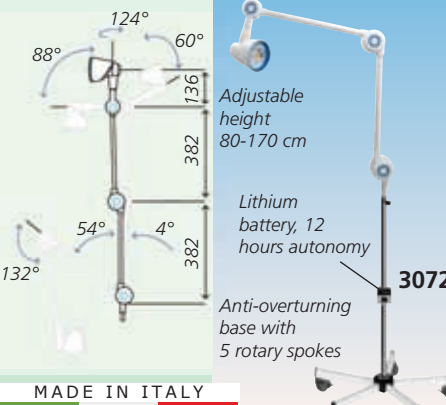

Adjustable height 80-170 cm

Lithium battery, 12 hours autonomy

Anti-overturning base with 5 rotary spokes

30728

MADE IN ITALY



Flexible tube

Adjustable height 72-147 cm

Anti-overturning trolley

30723

MADE IN ITALY



30756

30754

Height 50 cm (arm) + 95 cm (trolley)

MADE IN SPAIN

## ALFA-FIX AND ALFA-FLEX

Three LED light sources with coinciding lenses and polycarbonate protection shield. Thanks to three independent light sources, shadows can be reduced and provide a deep cylindrical light with highly reduced heat irradiation. Each LED integrates a resistance to ensure the continuous operation of the lamp even in the rare case of a LED fault.

### Design

New design makes the lamp extremely easy to use and manoeuvre, with an additional rotation of the reflector.

### Touch control

The light intensity can be adjusted through the touch button, a smooth touch of the control allows to regulate the light intensity from 4% to 100%.

### Interchangeable plugs

The transformer, integrated in the plug for a lighter and smooth movement

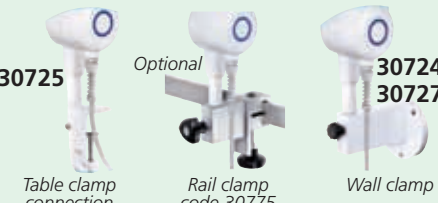

30725

Optional

30724,  
30727

Table clamp connection

Rail clamp code 30775

Wall clamp

of the arm structure, is supplied with interchangeable plugs (UK, US, EU). **Flexible arm (30723-5)**

The flexible arm ensures easier light positioning and is covered with a smooth white shrink-wrap sheath for easier cleaning and disinfection.

### Battery kit

Included with 30728, available in 45 days for 30723 (to be purchased with light). QR manual: GB, FR, IT, ES, PT.

GIMA code	ALFA-FIX AND ALFA-FLEX
30723	Alfa-flex LED - trolley
30724	Alfa-flex LED - wall
30725	Alfa-flex LED - table with clamp
30726	Alfa-fix LED - trolley
30727	Alfa-fix LED - wall
30728	Alfa-fix LED - trolley with battery

ACCESSORIES AND SPARE	
30766	Spare bulb Simplex - IRC 35 W for 30760-30763
30768	Spare trolley, base Ø 61 cm for Simplex and Alfaflex
30769	Spare trolley, base Ø 61 cm for Solesud2 and Alfafix
30775	Rail connection with clamp
30772	Spare glass Ø 8.5 cm for 30723-30727
30770	Spare glass Ø 12.3 cm for Solesud

Model	ALFA-FIX	ALFA-FLEX	LUXIFLEX	LED	LED Plus
Type of lighting	LED	LED	halogen	LED	LED Plus
Consumption (Watt)	8	8	35	6.5	10
Life of the bulbs (hours)	> 60,000	> 60,000	5,000	50,000	50,000
Light intensity at 50 cm (lux)	60,000	60,000	50,000	15,000	35,000
Light intensity at 1 m (lux)	20,000	20,000	-	-	-
Colour temperature ± 5% at 1 m (K)	4,500	4,500	4,000	4,500	4,500
Colour rendering index (Ra)%	94	94	95	80	97
Light field size at 50 cm (Ø mm)	150	150			
External Ø of the reflector (mm)	95	95	80	80	80
Colour	white	white	white	white	white
Norms	IEC 60601-1	IEC 60601-1	EN 60601-1-2		
Marks	EU 2017/745		CE 93/42		
Weight (kg)	5	5			
Operating voltage V	100-240	100-240	230	110/230	
Operating Hz	50/60		50/60		

- 30754 LUXIFLEX on trolley - halogen
  - 30756 LUXIFLEX on trolley - LED
  - 30755 LUXIFLEX PLUS on trolley - LED
- Stylish and versatile light for examination and minor surgery procedures in health-centres, clinics and hospitals. Suitable also for veterinary examinations and procedures. Class II.
- Safe low voltage operation without infrared radiation. Electronic transformer lodged at the bottom of the lamp. Flexible arm and 5 castors trolley allow easy use and movability.
- 30757 SPARE BULB LUXIFLEX - halogen

**35,000 LUX - LED PLUS**



**MIMSAL**

30755

Manual in:  
GB, FR, IT, DE, ES, PT

30755

MADE IN SPAIN

## HYRIDIA 7 LED LIGHTS - 65,000 LUX



65,000 LUX  
LED

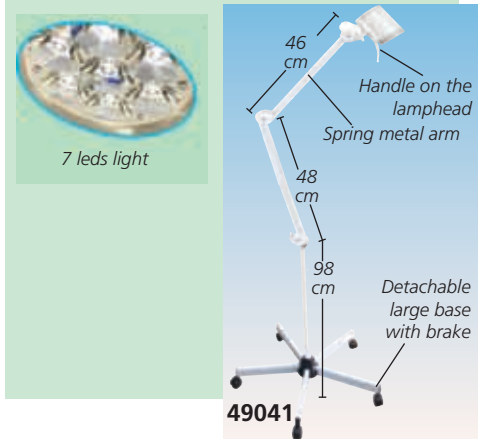

65,000 LUX  
LED

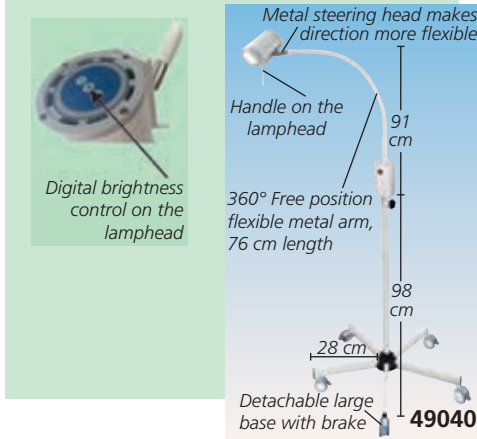

- 49040 HYRIDIA 7 LED LIGHT - flexible arm - trolley
  - 49041 HYRIDIA 7 LED LIGHT - metal spring arm - trolley
- 7 Leds 10 W medical procedure lights on trolley with flexible soft arm or metal spring arm. Digital brightness control.  
Manual: GB, FR, IT, ES, PT, DE, PL, GR.

### TECHNICAL SPECIFICATIONS

Consumption:	10 W	Light intensity and Light field Ø:			
Colour temperature:	4,800-5,500 °K	Illumination	Ø	Distance	
External Ø of reflector:	89 mm	78,000 lux	9 cm	30 cm	
Colour rendering index (CRI):	75 Ra	65,000 lux	12 cm	50 cm	
Operating voltage:	110-265 V, 50/60 Hz	22,000 lux	18 cm	100 cm	

## LUMINA LED LIGHT



37,000 LUX  
LED

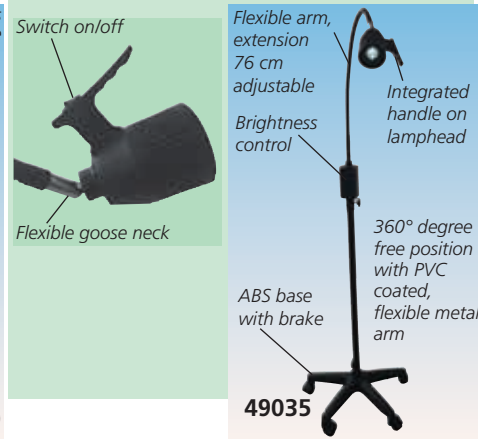

- 49035 LUMINA LED LIGHT - trolley
- Classic examination LED light with flexible arm.  
Manual: GB, FR, IT, ES, PT, DE, PL, GR.

### TECHNICAL SPECIFICATIONS

Consumption	3 W
Light intensity at 50/30 cm	37,000/89,000 lux
Colour temperature:	6,000 °K
External Ø of reflector:	75 mm
Colour rendering index (CRI):	75 Ra
Light field Ø:	4 cm at 50 cm
Operating voltage:	110-265 V, 50/60 Hz

## RI-MAGIC® HP LED LIGHT

- 49050 RI-MAGIC® HP LED - desk
  - 49051 RI-MAGIC® HP LED - trolley
  - 49052 RI-MAGIC® HP LED - wall
- High performance medical LED light for examination and procedures.
- high performance LED, 6,000 °K
  - lifetime of the lamp up to 50,000 hours
  - significantly reduced heating and energy loss
  - focusing device at the front of the light head
  - highly flexible, long special arm can be bent in all directions
  - rheostat handle for infinitely variable regulation of light intensity.
- Manual in: GB, FR, IT, ES, DE, RU.



MADE IN GERMANY

### TECHNICAL SPECIFICATIONS

Distance:	1,000 mm	800 mm	600 mm	400 mm	200 mm
Lux max:	15,000	20,000	30,000	45,000	55,000
Circle of light max Ø:	340 mm	270 mm	215 mm	155 mm	90 mm
Circle of light min Ø:	40 mm	35 mm	30 mm	25 mm	20 mm
Operating voltage:	100-240 V,	50-60 Hz			

## LED SPOT-ADJUSTED LIGHT

- 49047 LED SPOT-ADJUSTED LIGHT - trolley
- LED Spot examination lamp with multi-optical lens and light spot adjustable by inner mini light grating.
- Additional features:
- uniform and pure light spot
  - front optical lens
  - inner light grating
  - rear dual optical lens
  - 100 cm super long 360° free position and PVC coated flexible metal arm



### TECHNICAL SPECIFICATIONS

Bulbs/power:	1 LED / 5 W
Ø of lamp head:	25 mm
Illumination:	25,000 lux at 30 cm 10,000 lux at 50 cm max 70 mm, min 15 mm at 30 cm
Light field Ø:	
Colour temperature:	4,800°-6,000° K
Lamphead:	Ø 25 mm, length 125 mm
Power supply:	100-260 V, 50/60 Hz
Power cord:	length 272 cm

## MAGNIFYING LED COLD LIGHTS - 3 DIOPTRES

### GIMANORD PLUS

This model features a biconvex magnifying lens in optical glass with Ø 120 mm. The cold LED light allows prolonged use, without causing any eyesight problem. Polycarbonate screen for protection of the light source. Suitable for dermatology use. Medical device Class I.

#### Design

The new design makes the lamp extremely easy to use and manoeuvre, with an additional rotation of the reflector.

#### Touch control

Touch button allows to adjust light intensity from 4% to 100% with a smooth touch.

#### Interchangeable plugs

The transformer, integrated in the plug for a lighter and smooth movements of the arm structure, is supplied with interchangeable plugs (UK, US, EU).

#### TECHNICAL SPECIFICATIONS

Light intensity at 0.5 m (Ec)	2,250 lux
Colour temperature	5,370 K
Colour rendering index (CRI)	95 Ra
R9	≥90
Operating voltage	100-240 V - 50/60 Hz
Absorbed power	16.5 W
Light head diameter	23 cm
Average life	>60.000 hours
Norms	IEC-60601-1, IEC-60601-2-41, EU 2017/745

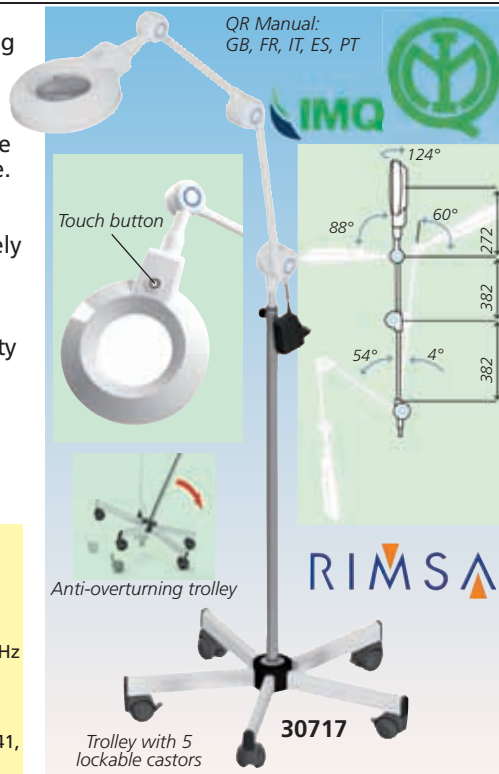

Magnifying glass  
Ø 120 mm

30716  
30717

QR Manual:  
GB, FR, IT, ES, PT

MADE IN ITALY

#### GIMA code LED MAGNIFYING LIGHTS

30716 GIMANORD PLUS - with table clamp

30717 GIMANORD PLUS on trolley

#### SPARES AND FIXING SYSTEMS

30720 Plexiglass shield for 30716-9 - spare

30771 Plexiglass shield for 30750-1\* - spare

30769 Trolley - base Ø 61 cm - spare

30774 Wall clamp - optional

\*Old models



## LED MAGNIFYING LAMP - 5 DIOPTRES

• 30737 LUPA LED MAGNIFYING LIGHT - trolley

• 30739 LUPA LED MAGNIFYING LIGHT - desk with clamp

Smartly designed white cold light LED lamp with 5-dioptres magnification. Generates a light without shadow. 5 wheels base and articulated arm allow easy movement. Manual in GB, FR, IT, ES, PT, DE. Medical device Class I.

#### TECHNICAL SPECIFICATIONS

Type of light:	60 LED - HF 6 W
Dioptres:	5
Lens:	Ø 12.7 cm
Colour temperature:	6,500 °K
Operating voltage:	110-230 V - 50/60 Hz
Class I	
Marks:	93/42/EEC
Lamp life:	40,000 hours

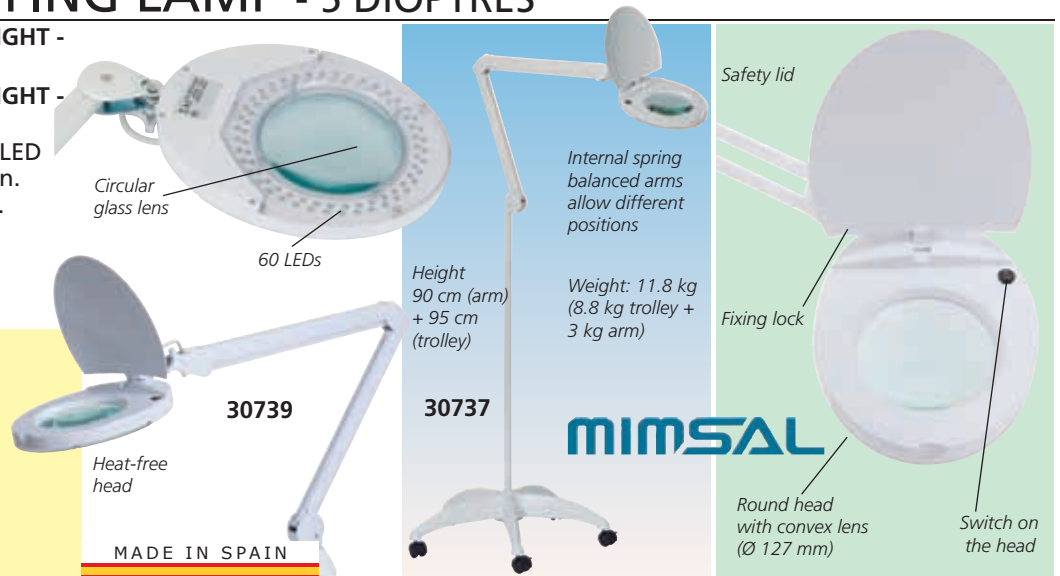

## LED MAGNIFYING LAMP - 3 DIOPTRES

• 30736 DERMALED MAGNIFYING LAMP

Cold light LED lamp with 3 dioptres magnifying glass lens and brightness adjustment.

It comes with a high stability 5 wheels base and an articulated arm for easy movement and fixing of the lamp. Manual in GB, IT.

#### TECHNICAL SPECIFICATIONS

Type of light:	LED
Voltage:	7 W
Dioptres:	3 (large glass)
Colour temperature:	7,500-9,500 °K
Light intensity at 20 cm:	2,400 lux
Operating voltage:	100-240 V - 50/60 Hz
Net/Gross weight:	12.8-15 kg

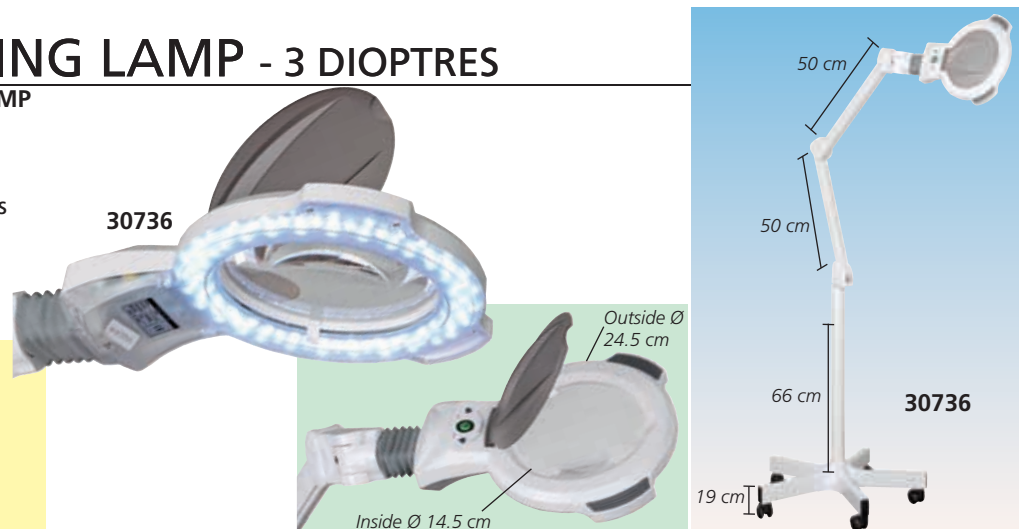

## VISTA WOOD BLUE LIGHTS: TROLLEY AND MANUAL

- 31196 VISTA WOOD LAMP - handle
  - 31197 VISTA WOOD LAMP - trolley
- A Wood lamp is a diagnostic tool to diagnose the condition of skin. Different skin conditions under ultraviolet rays of the Wood lamp appear in different colours. These models have polished glass magnifying lens 10x6 cm - 3 dioptries. 9W special compact fluorescent tube at approximately 360 nm wavelength. Operating voltage: 230 V - 50 Hz. Manual in GB, FR, IT, ES, PT, DE.
- 31201 FLUORESCENT TUBE 9W - spare for 31196-31197



**MIMSAL**  
MADE IN SPAIN

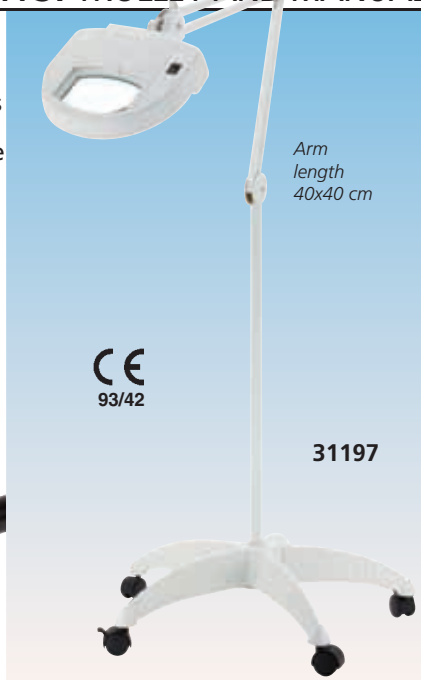

## MACRO LENS 12X

- 31155 SMARTPHONE MACRO LENS 12X
- Macro lens 12X for allergists, dermatologists, phlebologists, aesthetic surgeries. Can be mounted on any smartphone to take magnified images. Supplied with clip compatible with any smartphone, 10x10 cm wipe and multilingual manual (GB, FR, IT, ES, PT, DE, PL, GR).



## ECONOMIC WOOD LAMP

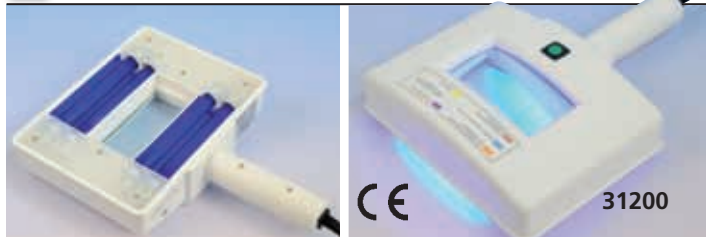

- 31200 WOOD LAMP
- Ultraviolet light for skin condition analysis. Size 30x21x7 cm. Operating voltage: 220-240 V, 50/60 Hz.
- 31202 FLUORESCENT TUBE - spare

## POCKET WOOD LIGHT



- 31189 POCKET WOOD LIGHT
- Pocket ultraviolet light, to detect skin disorders. Provided with replaceable fluorescent lamp. Power 6 W. Works with 4xAA batteries with 4-6 hours autonomy.
- 31190 FLUORESCENT TUBE - spare

## DIGITAL Wi-Fi POLARISED DERMATOSCOPE, CAPILLAROSCOPE, MICROSCOPE

An innovative line of handheld colour digital microscopes: dermatoscope with polarized filter, capillaroscope and iridoscope with Wi-Fi wireless transmission. Small, easy to operate, light and portable. They can be used with all the most popular smartphones, tablet and PC.

Basic software for acquisition of photos and videos. Google/Apple applications included. Designed in Italy, manufactured in China. Directive 93/43/CEE - Medical device Class I (only 32181 and 32183).



- 32181 Wi-Fi DERMATOSCOPE with polarized filter

DERMATOSCOPE SPECIFICATIONS	
Magnification:	5X to 200X
Light source:	8 adjustable white LED
Lens:	High definition microscopy lens



- 32183 Wi-Fi CAPILLAROSCOPE

CAPILLAROSCOPE SPECIFICATIONS	
Magnification:	500X to 600X
Light source:	8 adjustable white LED
Lens:	High definition microscopy lens



- 32184 Wi-Fi MICROSCOPE
- Advised to view the iris.

MICROSCOPE SPECIFICATIONS	
Magnification:	30X
Light source:	2 adjustable white LED+ 2 adjustable yellow LED
Lens:	High definition microscopy lens

TECHNICAL SPECIFICATIONS		
Operation system	Windows (7, 10), OS X, iOS, Android (it can be used by Wi-Fi or USB)	<b>CAMERA</b>
Photo and video resolution	1.3 MPixels - 1280x1024 (MJPG), 640x480 (MJPG), 320x240	Camera sensor CMOS 1/4"
Frame rate	15 fps 1,280x1,024, 30 fps 640x480 320x240	Optical features Exposure: Auto, Gamma: Auto, White balance: Auto, Black reference: Auto
Wi-Fi wireless transmission distance	Up to 5 m	
Power consumption	Max 2.5 W	
Li-ion battery	Continuous working time - appx. 2 hours, full charging time - appx. 2 hours	
Power source - Size - Weight	DC 5.0V / 1A - Ø 36x142 mm - 88 g	

STANDARD ACCESSORIES	
Caps of contact (only for 32181)	
USB AC adapter	
USB cable	
Quick manual	
Plastic stand	
Line calibration ruler (only 32181)	
Manual (GB, FR, IT, ES, DE)	
CD basic software Win (GB, FR, IT, ES, DE, UA, JP), Mac (GB)	



## HEINE DELTA 20® T LED<sup>HQ</sup> DERMATOSCOPES 10X - 16X

- **31161 HEINE DELTA 20® T LED<sup>HQ</sup> DERMATOSCOPE 3.5V (Li-ion)** for polarization and immersion with rechargeable handle for mains socket and USB cable - **K-262.28.388**

**Precision HEINE Optics** - high quality, achromatic optical system provides unsurpassed sharpness and resolution. Focusing system provides from 10X to 16X magnification for detection of even the smallest details and structures.

**LED in HQ** - the new standard in LED illumination defining optimal light intensity, homogeneity and colour rendering for each individual examination - Colour temperature: 5.000 K, Colour Rendering Index (CRI) > 80 on a scale of 100. This ensures true tissue colour for the most accurate diagnosis.

**Toggle between polarised and non-polarised illumination modes** - alternation between two modes with the press of a button, no exchange of contact plates necessary. Allows recognition of the "Blink Sign" when observing crystalline structures and presence of milia cysts, increasing diagnostic function.

**Optional small contact plate** for difficult to access lesions.

**Digital documentation capabilities** - Heine SLR photo adaptor allows to connect any Delta 20 dermatoscope to major brands of digital cameras.

**LED Thermal Management** - ensure long-term performance and product stability. Carefully selected and applied heat-diffusing materials guarantee up to 50.000 hours.



Supplied with hard case, dermatology compendium.

- **31162 HEINE DELTA T LED DERMATOSCOPE HEAD with contact plate with graduated scale** - **K-008.34.221** (can be used with any Heine Beta handle). Supplied with compendium.
- **31179 SMALL CONTACT PLATE Ø 8 mm** - **K-000.34.205**
- **31171 SLR PHOTO ADAPTOR - for Canon**
- **31173 SLR PHOTO ADAPTOR - for Nikon**
- **31169 ADAPTOR CORD - 1.30 m**



## HEINE MINI 3000 DERMATOSCOPES

- **31184 HEINE MINI 3000 XENON-HALOGEN DERMATOSCOPE 10X - D-001.78.107**

Pocket dermatoscope with high-quality optics, 10X magnification with focusing optics, metal head.

**Xenon Halogen bulb.** Concentrated, bright light for uniform illumination with exact colour rendering.

**High quality colour-neutral optic system** with achromatic lenses, provides sharp images.

**Contact plate** without scale.

Supplied with dermoscopic compendium. Operates with AA batteries or rechargeable batteries (31693) + Mini 3000 NT charger (31692) not included.

- **31160 HEINE MINI 3000 LED<sup>HQ</sup> DERMATOSCOPE 10X - D-008-78-109** - same as 31184, with the addition of:

**High-performance bright and homogeneous LED illumination** with an excellent colour rendering (index >95). Colour temperature 4,000 K.

**Twice brighter light** compared to Xenon Halogen

**Maintenance free.**

**Fade-out function:** reduces illumination intensity with battery level to let you know when to replace.

**Up to 10 hours operation time.**

- **31692 HEINE MINI 3000 NT CHARGER - X-001.99.484**
- **31693 BATTERY+BASE - X-001.99.487 + X-001.99.488**



## POLARIZED+UV+WHITE LED DERMATOSCOPE

- **32177 WI-FI - USB DIGITAL POLARIZED+UV+WHITE LED DERMATOSCOPE with software**

Dermatoscope with polarized filter is a very innovative handheld colour digital device with USB and WI-FI transmission. Suitable for skin and scalp. Small, easy to operate and portable. 3 types of lighting: white, UV and white polarized LEDs.

Magnification: 60x and 200x with 7 mm spacer ring or closed cap  
30x with transparent tube

MDR 2017/745/UE - Medical Device Class I

**Mic-Fi DERMA software** for Windows (GB, IT) and MAC (GB) to capture photos, compare images, history and reporting, data base for patients and selection of the point where analysis is carried out.



TECHNICAL SPECIFICATIONS			
Operating mode:	continuous	Frame rate:	15 frame/sec.
Camera:	Colour CMOS 1/2.5"	Image format:	bmp, jpg
LEDs:	4 white, 4 UV and 4 polarized adjustable LEDs	USB:	USB 2.0, 2 mt
Lens:	high definition microscopy lens	Battery:	Li-ion
Resolution:	1.3 Mpixel	Working time:	2 hours
		Power supply:	DC 5.0 V/1A
		Consumption:	Max 2.5 W
		Size - weight:	36x142 mm - 88 g

STANDARD ACCESSORIES		
USB cable	Ruler	1 Bag L + 1 bag S
USB AC Adapter	Contact closed cap	Quick guide + manual (GB, FR, IT, ES, DE)
USB foot pedal	Tube	CD Mic-Fi Derma Software

## GIMA XENON HALOGEN SKIN SURFACE MICROSCOPE 10X

- **31187 GIMA XENON HALOGEN DERMATOSCOPE 2.5 V - 10X**

Advanced skin surface microscope offers long-lasting halogen illumination for the true tissue colour and 10X magnification for greater details, allowing accurate diagnoses of pigmented skin lesion.

Supplied in a useful bag, with spare autoclavable contact plate with 0-10 mm scale. Latex free.

- **32203 "C" BATTERIES - blister of 2 pcs.**
- **31479 XENON HALOGEN BULB - 2.5V - spare**
- **31185 SKIN LESION GAUGE - 21x5 cm**

Available with your logo for min. 2,000 pcs.



TECHNICAL SPECIFICATIONS	
Battery:	2x "C" or rechargeable battery (34479) + charger (31542)
Reticle contact plate	
Easy to focus, with large focus ring	

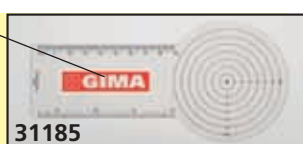

# RIESTER RCS-100 MEDICAL DIAGNOSTIC CAMERA SYSTEM



32150  
+  
32156

MADE IN GERMANY

## • 32150 RIESTER RCS-100 WIRELESS MEDICAL CAMERA SYSTEM - without lens

RCS-100 is a multi-functional, portable and versatile medical diagnostic camera system that allows the user to quickly and efficiently capture and share images and videos to improve diagnosis, monitoring, treatment and patient care. It provides the additional benefit of capturing and sharing the digital photograph or video of the ear canal and tympanic membrane, epidermis and dermis of skin, respectively. RCS-100 can be used with: general lens, otoscope lens, dermatoscope lens and endoscope adapters.

### Features:

- 5" full HD colour TFT-LCD display 1.280 x 720 pixels provides high resolution, scalable images with 2x - 8x magnification and digital zoom capabilities
- easy to use touch screen makes it quick to capture images and videos
- rotary wheel for one-handed operation minimises the risk of cross contamination as well as the capability to adjust focus and light intensity
- simple lens connection makes changing fast and easy
- li-ion battery offers 3.5 hours of operating time
- improved communication in remote areas
- images and videos can support medical notes allowing consistent monitoring of patient
- USB connection to transfer files to PC and for charging
- UVC function allows live picture display on a second screen, so the user can show what they can see and explain in real time
- Wifi connection

Multilingual manual: GB, FR, IT, ES, DE.



Portable and versatile digital diagnostic camera. Multiple lens attachments, enabling instant sharing

GIMA code	Riester code	RCS-100 ACCESSORIES
32152	13277	Endoscope adapter 4° *
32153	13278	Endoscope adapter 9° *
32154	13270	Dermatoscope lens
32155	13271	General lens
32156	13272	Otoscope lens
32158	10801-532	Disposable ear speculum Ø 2 mm - box of 10
32159	10801-534	Disposable ear speculum Ø 4 mm - box of 10

**ENDOSCOPE ADAPTER**  
compatible with C-mount standard



32152

**GENERAL IMAGING LENS**



32155

**DERMATOSCOPE LENS**  
with digital ruler for measurements



32154

**OTOSCOPE LENS**  
with pneumatic otoscopy port



32156

## TECHNICAL SPECIFICATIONS

<b>Device</b>		<b>Object Distance:</b>	0 mm
<b>Display:</b>	TFT-LCD 5.0" touch screen display, 1280x720 pixels with 2x-8x magnification and digital zoom automatic/manual	<b>Magnification</b>	optical: 2x digital: 4x displayed: 2x-8x
<b>Focus:</b>	8 MP	<b>Photography source:</b>	natural light LED
<b>CMOS pixels:</b>	picture: JPEG, video: MP4	<b>LED color temperature:</b>	4000k
<b>Image/video format:</b>	2G LPDDR3	<b>Size - weight:</b>	62.1x62.1x36 mm - 108.5 g
<b>RAM:</b>	16GB	<b>General lens</b>	
<b>Rom:</b>	16G wifi SD card	<b>Focal length/width:</b>	2.0
<b>Extend Memory:</b>	3.6V 2600mAh 18650 li-battery	<b>Field angle:</b>	78°
<b>Battery:</b>	video 3.5 hours (fully charged battery)	<b>Depth of field scope:</b>	30mm ~ 4m
<b>Operating time:</b>	3 hours	<b>Lighting source:</b>	natural light LED
<b>Charging time:</b>	input 100~240V 50~60Hz 0.3A	<b>Magnification</b>	optical: 2x digital: 4x
<b>Adaptor:</b>	output DC 5V/2A	<b>LED colour temperature:</b>	5500k
<b>USB:</b>	OTG and type-C USB	<b>Size - weight:</b>	60.5x 60.5x19.0 mm - 66.4 g
<b>Size - weight:</b>	225x135xh 45 mm - 292g	<b>Otoscope lens</b>	
<b>*Endoscope adapter</b>		<b>Focal length/width:</b>	2.9
<b>Compatibility:</b>	Compatible with flexible and rigid endoscopes with diameters from 2.7mm to 10mm (two versions planned, one optimized for optics between 2.7-4mm and one for 4-10mm) from a broad range of leading manufacturers based on C-mount standard (e.g. Wolf, Storz, Olympus, Scholly)	<b>Field of view:</b>	12mm Ø field of view at 25mm distance from viewing object (with 4mm specula size) 9mm Ø field of view at 15mm distance from viewing object (with 4mm specula size) 8mm Ø field of view at 10mm distance from viewing object (with 4mm specula size)
<b>Quick coupling:</b>	Adapter can be attached to RCS-100 and a C-Mount endoscope quickly and it's ready to use	<b>Max object distance:</b>	15mm, at max object distance FOC Ø: 15mm
<b>Dermatoscope lens</b>		<b>Depth of field scope:</b>	10mm
<b>Focal length/width:</b>	2.2	<b>Lighting source:</b>	natural light LED
<b>Polarization:</b>	dermis / epidermis	<b>Magnification:</b>	display: 6x
<b>Field of view:</b>	30mm Ø	<b>LED colour temperature:</b>	4000 K
		<b>Size - weight:</b>	73.5x40.0x40.0 mm - 96 g

# MD SCOPE VIDEO OTOSCOPE

## MD SCOPE VIDEO OTOSCOPE

### Instant View

A clear and sharp image can be acquired and displayed instantly on a built-in screen. Just press a single button and wait for 3 seconds.

### Real Time Interaction

Medical image can be captured and shared simultaneously to improve interaction between health professionals and patients.

### Electronic medical record

A medical image is automatically generated to support most of the stand-alone health information system. Simply plug the cable into the video-out socket to retrieve the image.

With video otoscope MS102



25.5x16x7 cm

32163

32161, 32162

Size: 7.5x6.3x21.2 cm

Weight: 180 g

With video otoscope MS101



32162

MS101

MS102



Colour LCD display 2.4" (32161-2) 3" (32163)

Image freeze function

Video out port

Image resolution 320x240 pixels (32161-2) 640x480 pixels (32163)

CE FDA US pat. n° 8206290

Size: 9.5x8.5x21 cm

Weight: 250 g

Image zoom in/out

Built-in Image storage: 1,000 photos

Brightness control

Li-ion rechargeable battery lifespan: 4 hours

32163

### • 32163 ELITE PACK MS102

- MD Scope with
- 1 camera probe 47 mm Ø 4.2 mm
- mini USB cable set
- 12 disposable specula
- internal Li-ion battery and charging cradle
- carrying case

### • 32161 DELUXE PACK MS101 - 2 cameras

### • 32162 DELUXE PACK MS101 - 4 cameras

- MD Scope with
- 2 camera probes 45 (Ø 5.2 mm)/150 (32161)
- 4 camera probes 45 (Ø 5.2 mm)/75/150/300 mm (32162)
- image dongle (32162 only)
- cable set (32176): USB and RCA cable, adaptor for image dongle
- 24 disposable specula
- 2 AA alkaline batteries
- carrying case

Detachable camera modules are designed for different examinations as needed



32165 Ear 32167 Ear + nose 32168 Oral 32169 Larynx

A video port provides simultaneous image to display on TV/monitor or to download to Mac/PC system

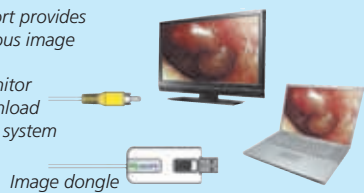
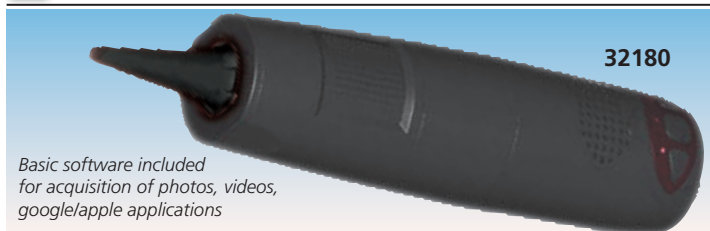

Image dongle

GIMA code	ACCESSORIES AND SPARE PARTS
32165	Camera probe 45 x Ø 5.2 mm - adult
32166	Camera probe 47 x Ø 4.2 mm - adult/child
32167	Long camera probe 75 x Ø 5.2 mm
32168	Flexible camera probe 150 x Ø 5.2 mm
32169	Long flexible camera probe 300 x Ø 5.2 mm
32172	Disposable rigid specula 37 x Ø 5 mm for 32165 - 32166 box of 250
32173	Reusable silicone specula 36 x Ø 4.2 mm for 32166 - box of 24
32175	Cradle for video otoscope 32160 - 32162
32176	Cable set (USB and RCA cable, adaptor)
32174	Charging cradle for video otoscope 32163

# DIGITAL Wi-Fi & USB VIDEOTOSCOPE + SOFTWARE



32180

Basic software included for acquisition of photos, videos, google/apple applications

• **32180 Wi-Fi & USB VIDEOTOSCOPE with software**  
Innovative, handheld colour digital Otoscope with Wi-Fi wireless transmission. Small, easy to operate, light and portable. It can be used with all the most popular smartphones, tablets and even with PC. Designed in Italy, made in China.

• **32188 DISPOSABLE EAR SPECULUM Ø 3.5 mm - black - box of 100**

• **32189 DISPOSABLE EAR SPECULUM Ø 4.3 mm - black - box of 100**

• **32192 DISPOSABLE VET SPECULUM Ø 5/6/7 mm and Ø 7/8 mm slotted for Hartmann Tweezers - kit of 5**



32192

## TECHNICAL SPECIFICATIONS

Operation system:	Windows (7, 10), Mac (OS X 10.7 and following), iOS, Android
Photo and video resolution:	1.3 MPixels - 1,280x1,024 (MJPG), 640x480 (MJPG), 320x240
Frame rate:	15 fps 1280x1024, 30 fps 640x480 320x240
Wi-Fi wireless transmission distance:	up to 5 m
Power consumption:	max 2.5 W
Li-ion battery:	continuous working time - approx. 2 hours, full charging time - approx. 2 hours
Power source:	DC 5.0 V / 1A
Size - weight:	Ø 36x142 mm - 88 g
<b>Camera</b>	
Camera sensor:	CMOS 1/4"
Optical features:	Exposure: Auto, Gamma: Auto, White balance: Auto, Black reference: Auto
<b>Otoscope</b>	
Magnification:	25 X - 50 X
Focus range:	8-160 mm
Object distance:	1-160 mm
Light source:	4 adjustable white LED
Lens:	high definition microscopy lens
Software interface:	Mic-Fi Apps for Android and iOS system and Mic-Fi softwares for PC and MAC

## STANDARD ACCESSORIES

9 disposable speculum (3x3.5, 3x4.3, 3x5.0 mm)	Plastic stand
USB AC adapter and cable	Manual (GB, FR, IT, ES, DE)
CD basic software Win (GB, FR, IT, ES, DE, UA, JP) Mac (GB)	

# HEINE OMEGA® 600 HIGH-END LED<sup>HQ</sup> INDIRECT OPHTHALMOSCOPE

• **31755 HEINE OMEGA 600 LED INDIRECT OPHTHALMOSCOPE - C-008.33.610**

Omega 600 is a binocular lightweight high-end indirect ophthalmoscope which provides best optics, sharpest image and reliable colours. Possibility to explore the whole retina, including the far periphery, and to have better diagnostic due to unique visionBOOST function. VisionBOOST allows to safely increase illumination of the device above the regular light intensity, providing up to 20% more details of the observed area, especially in patients with ocular media opacities like cataracts. Features:

- sharpest fundus image due to superior glass optics
- brightest fundus image with true colour rendering thanks to unique LED<sup>HQ</sup>
- best 3D imaging due to unique Stereoscopic Adjustment Technology in dilated and undilated pupils, even with premature and newborns
- ergonomic positioning of controls and levers
- adaptable for right and left users
- flip-up function for more convenient patient interactions
- robust design made of high quality materials
- compact lithium battery
- electronics integrated in the headband
- best wearing comfort
- latex free.

MADE IN GERMANY

**Ultralight lithium polymer battery** operating time of up to 8 hours depending on illumination intensity.

**Durable faux leather padding** Comfortable and easy to disinfect

**Practical, cable-free headband** maintenance-free and easy to disinfect thanks to smooth surface.

**Intuitive locking of the optics unit** simply adjust height, distance and angle

**Up to 20% better view in media opacities with visionboost.** From 3 to 100%, or even up to 245% for cataract examinations

**Aperture selection lever** HEINE diffusor, small, medium and large spot



**Yellow, blue or red-free filter** to adjust to diagnostic needs

**Best possible 3D imaging for any pupil size and peripheral views** thanks to the Stereoscopic Adjustment Technology

**High durability due to the sealed optics unit**  
**Better view due to non-reflective front glass** optimized for our unique, maintenance-free Led<sup>HQ</sup>

Supplied with battery, +2D eyepiece, E4-USBC power supply with cable, eyepiece 0D and multilingual manual: GB, FR, IT, ES, PT, DE, NL, SE, DK, NO, FI.

### TECHNICAL SPECIFICATIONS

Material:	plastic, metal, glass, synthetic leather	Field of view:	16D lens: 43°, 20D lens: 53°, 30D lens: 63°
Optical system:	aspherical illumination distance	Brightness control:	continuous between 3 and 100% (boost: 100 to 245%)
Illuminance:	560 lux at 400 mm distance 1380 lux at 400 mm distance with Boost mode	Vertical adjustment:	between -4° and +7°
Colour temperature:	3000 K	Battery:	internal Lithium polymer battery
Colour rendering index (CRI):	min. 90	Average working time:	up to 8 hours
LED average life:	> 60,000 hours	Charging time:	1.5 hours
Working distance:	400 mm	Input:	USB 2.0 Type C, 5 V, 1.2 A
Illuminated field:	large spot: 400 mm distance Ø 62.5 ± 2.5 mm medium spot: 400 mm distance Ø 33 ± 2 mm small spot: 400 mm distance Ø 16.5 ± 1.5 mm	Power consumption:	6 W
		Size - weight:	320x300x200 mm - 475 g
		Packaging size:	255x190x410 mm
		Norms:	93/42/EEC, EU 2017/745 - Class I

# WELCH ALLYN MACROVIEW™ OTOSCOPE

• **32100 MACROVIEW™ HEAD - 23810**  
• **32101 LITHIUM ION HANDLE WITH AC CHARGING MODULE 3.5 V - 71902**

This otoscope features advanced optics that increase magnification while giving a nearly full view of the tympanic membrane - virtually eliminating the need for panning. With its easy-to-focus eyepiece, MacroView allows for enhanced visualization to help see past wax, locate fluid behind the eardrum, and even perform exams without your glasses.

- twice the field of view
- 30% greater magnification than a traditional otoscope
- better clarity and definition of landmarks
- ability to adjust focus for variable ear canal lengths or farsighted eyes

• **32106 KLEENSPEC® ADULT DISPOSABLE EAR SPECULA 4.25 mm - box of 850 pcs - 52434-UB**  
• **32105 KLEENSPEC® PEDIATRIC DISPOSABLE EAR SPECULA 2.75 mm - box of 850 pcs - 52432-UB**  
• **32135 SPARE HALOGEN BULB - 3.5 V - 06500 U**

**Adjustable focus wheel** allows to accommodate for variable ear canal lengths and farsighted eyes a full view of the tympanic membrane

**Default focus position** (the dot and the line)

**Advanced optics** give you 2X the field of view and 30% greater magnification than a conventional otoscope

WelchAlllyn®

**Tip grip** ensures ear specula is fastened securely and easily disposed

**Insufflation port** for pneumatic otoscopy



**Lithium-ion handle with AC charger module** compatible with all Welch Alllyn instrument heads 3.5 V

32100

32101

# DIGITAL WI-FI & USB IRISCOPE WITH SOFTWARE AND CHINREST

• **32179 DIGITAL WI-FI IRISCOPE with software and stand**  
Innovative handheld colour digital iriscope with Wi-Fi wireless transmission. Small, easy to operate, light and portable. **2 adjustable white LEDs and 2 adjustable yellow LEDs.** It can be used with all the most popular smartphones, tablet and even PC.

**Iridology professional software** (USB mode only) compatible with Windows 7, 8, 10, 11, available in GB, IT. Not medical device.

32179



Resolution: 5 Mpixel\*

\*only by USB mode

### STANDARD ACCESSORIES

USB AC adapter Ring  
Quick manual: GB, IT  
Software for Windows 7, 8, 10, 11 (GB, IT)

### TECHNICAL SPECIFICATIONS

Magnification:	30x
Camera:	CMOS 1/2.7"
Light source:	2 white leds and 2 yellow leds
LED system:	3.2 V/20 ma
Resolution:	5 Mpixel in USB mode
Lens:	high definition microscopy lens
Frame rate:	15 frames/second (1280x1024), 30 frames/second (640x480) 320x240
Power supply:	Li-ion battery, DC 5.0V/1A
Working time:	continuous working, 2 hours fully charged
Power consumption:	2.5 W
Size - weight:	Ø 36x142 mm - 88 g

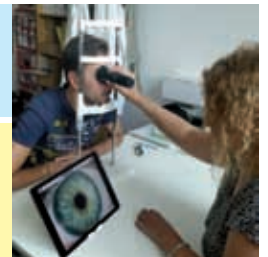









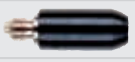

## HEINE ORIGINAL BULBS

HEINE BULBS	HEINE ref.	GIMA code	Compatible with following HEINE products
 Xenon 2.5 V	<b>035</b>	<b>31769</b>	Transilluminator Finoff alpha+ F.O. and F.O. SP Laryngoscopes - Sanalon handle Glaucotest
 Xenon 2.5 V	<b>037</b>	<b>31771</b>	K100 and Beta® 100, Beta® 100 vet otoscopes Laryngeal mirrors F.O. mini 2000 otoscope Alpha® and Alpha F.O. otoscopes Mini/mini 3000/Alpha/Beta tongue holders
 Xenon 3.5 V	<b>049</b>	<b>31787</b>	F.O. Alpha+, Beta 100, K 100, Beta 100 vet otoscopes; Alpha+, Beta® tongue holders
 Miroflex ophthalmoscope	<b>038</b>	<b>31773</b>	Miroflex ophthalmoscope HFR2 spot retinoscope Delta®10 dermatoscope
 Fibralux mini otoscope	<b>041</b>	<b>31774</b>	Fibralux mini otoscope Mini 2000 combilamp Mini 1000, 2000 cliplamp
 Alpha ophthalmoscope	<b>042</b>	<b>31780</b>	Alpha® ophthalmoscope Mini 2000 ophthalmoscope Alpha® Focalux, Mini 2000 Focalux Mini Miroflex ophthalmoscope
 Minilux otoscope	<b>056</b>	<b>31770</b>	Minilux otoscope Mini 2000 otoscope
 Beta® 200, 200 M2, 200S ophthalmoscopes - XHL 2.5 V	<b>069</b>	<b>31781</b>	Beta® 200, 200 M2, 200S ophthalmoscopes - XHL 2.5 V
 Beta® 200, 200 VET, 400; K 180 otoscopes	<b>077</b>	<b>31772</b>	Beta® 200, 200 VET, 400; K 180 otoscopes Lambda 100 retinometer Delta®10 plus dermatoscope
 Xenon 2.5 V	<b>070</b>	<b>31783</b>	Beta 200, 200 M2, 200S opthalmoscopes - XHL 3.5V
 Xenon 2.5 V	<b>078</b>	<b>31784</b>	Beta 200, 200 Vet, K180 otoscopes lambda 100 retinometer otoscopes - XHL 3.5V
 Xenon 2.5 V	<b>084</b>	<b>31782</b>	K180® ophthalmoscope - 2.5 V
 Mini 3000 F.O. otoscope	<b>105</b>	<b>31776</b>	Mini 3000 F.O. otoscope
 Mini 3000 ophthalmoscope	<b>106</b>	<b>31777</b>	Mini 3000 ophthalmoscope
 Mini 3000 combilamp and cliplamp - XHL 2.5 V	<b>107</b>	<b>31778</b>	Mini 3000 combilamp and cliplamp - XHL 2.5 V
 Mini 3000 dermatoscope	<b>109</b>	<b>31779</b>	Mini 3000 dermatoscope
 Mini 3000 otoscope	<b>110</b>	<b>31775</b>	Mini 3000 otoscope
 Alpha®, Beta 200 retinoscopes	<b>089</b>	<b>31786</b>	Alpha®, Beta 200 retinoscopes

## WELCH ALLYN BULBS

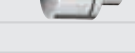
WELCH ALLYN BULBS	W. A. ref.	GIMA code	Compatible with following WELCH ALLYN products
 Anoscopes	<b>00200-U</b>	<b>32120</b>	Anoscopes: 38800, 380, 385, 395 Illuminators: 41000, 26030 Old products: 235, 77900, 26000, 20100, 21600, 42700, 40510
 Ophthalmoscope	<b>03000-U</b>	<b>32123</b>	Ophthalmoscope: 11710, strabismoscope: 12400, episcope: 47300 Old ophthalmoscope: 11600, 11605, 11610 Retinoscope: 18000
 Otoscope	<b>03100-U</b>	<b>32124</b>	Otoscopes: 25020, 21700, 20200 Handle: 73500, holder: 28100 Illuminators: 27000, 27050, 26530, 41100, 43300 Old otoscopes: 25000, 25200, 20000
 Ophthalmoscope	<b>03300-U</b>	<b>32125</b>	Ophthalmoscope: 11511-11500
 Otoscope	<b>03400-U</b>	<b>32126</b>	Otoscopes: 24011-24020-24000-24031-21110/1 Handle: 73550, Illuminators: 27200-27250-41110
 Pan optic	<b>03800-U</b>	<b>32127</b>	Pan optic: 11810-11820-11800
 Exam light	<b>04100-U</b>	<b>32128</b>	Exam light: 48400-48410
 Exam light	<b>04200-U</b>	<b>32129</b>	Exam light: 48600, 48610-48625-48635, 48700
 Ophthalmoscopes	<b>04400-U</b>	<b>32130</b>	Ophthalmoscopes: 11400-11411-11470-11475
 Laryngo	<b>04700-U</b>	<b>32131</b>	Laryngo: 680, 690, 692 (size 1-2) Old laryngo: 634, 664, 674, 684, 694 (check size)
 Laryngo	<b>04800-U</b>	<b>32132</b>	Laryngo: 680 (size 2-4), 690, 692 (size 3-4) Old laryngo: 634, 640, 664, 674, 684, 694 (check size)
 Ophthalmoscope	<b>04900-U</b>	<b>32133</b>	Ophthalmoscope: 11720, 11730, 11735, 11620, 11630
 Laryngo handles	<b>06000-U</b>	<b>32134</b>	Laryngo handles: 60813, 60814, 60713, 60815, 60803, 60804
 Macroview otoscope	<b>06500-U</b>	<b>32135</b>	Macroview otoscope: 23810, 23820
 Handle	<b>07800-U</b>	<b>32136</b>	Handle: 73211, 73210, 78000, 73200

## RIESTER ORIGINAL BULBS

RIESTER BULBS	RIESTER ref.	GIMA code	Bulb	Compatible with following RIESTER products
 Vacuum 2.7 V	<b>10421</b>	<b>31850</b>	Vacuum 2.7 V	Otoscope uni*/speculight
 Vacuum 2.5 V	<b>10424</b>	<b>31851</b>	Vacuum 2.5 V	May-ophthalmoscope uni®
 XL 3.5 V xenon	<b>10487</b>	<b>31825</b>	XL 3.5 V xenon	Otoscope ri-scope® L1
 Pen-scope® and e-scope® otoscope	<b>10488</b>	<b>31852</b>	Vacuum 2.7 V	Pen-scope® and e-scope® otoscope
 Otoscope pen-scope®/ ri-scope® L1 and e-scope®	<b>10489</b>	<b>31560</b>	XL 2.5 V	Otoscope pen-scope®/ ri-scope® L1 and e-scope®
 Otoscope uni®	<b>10590</b>	<b>31853</b>	XL 2.5 V	Otoscope uni®
 Otoscope ri-mini®, ri-scope® L2/L3 and e-scope®	<b>10600</b>	<b>31854</b>	XL 2.5 V	Otoscope ri-mini®, ri-scope® L2/L3 and e-scope®
 Ophthalmoscope ri-mini/ ri-scope® L1, L2, L3, e-scope®, ri-derma®	<b>10605</b>	<b>31562</b>	XL 2.5 V	Ophthalmoscope ri-mini/ ri-scope® L1, L2, L3, e-scope®, ri-derma®
 Ri-scope® otoscope L2, L3	<b>10607</b>	<b>31855</b>	XL 3.5 V	Ri-scope® otoscope L2, L3
 Ri-scope® ophthalmoscope L1, L2, L3	<b>10608</b>	<b>31826</b>	XL 3.5 V	Ri-scope® ophthalmoscope L1, L2, L3
 E-scope F.O otoscope	<b>14041</b>	<b>31561</b>	LED 3.7 V	E-scope F.O otoscope
 E-scope ophthalmoscopes	<b>14051</b>	<b>31563</b>	LED 3.7 V	E-scope ophthalmoscopes



## COMPATIBLE GERMAN BULBS

GIMA BULBS	GIMA code	Compatible with the following products
<b>LARYNGOSCOPE BULBS - MADE IN GERMANY</b>		
 Conventional laryngoscope SMALL bulb 2.7 V	<b>34324</b>	Gima, Riester, And, Kawe, Timesco Truphatek and most of conventional laryngoscopes in the market (generally used for blades N° 00, 0, 1)
 Conventional laryngoscope LARGE bulb 2.7 V	<b>34325</b>	Gima, Riester, And, Kawe, Truphatek, Timesco and most of conventional laryngoscopes in the market (generally used for blades N° 2, 3, 4)
 Xenon halogen bulb for F.O. Laryngoscope and otoscope	<b>34485</b>	Gima, And, Kawe and most of F.O. laryngoscopes in the market. Compatible for products that use Heine Bulb # 035
<b>OTOSCOPE-OPHTHALMOSCOPE BULBS - MADE IN FRANCE-GERMANY</b>		
 Xenon halogen otoscope bulb	<b>31795</b>	Heine mini 3000 otoscopes
 Xenon halogen F.O. otoscope bulb	<b>31796</b>	Heine mini 3000 F.O. otoscopes
 Otoscope bulb 2.5V	<b>31449</b>	Parker otoscopes and some otoscopes of Riester, Timesco and Kawe
 Ophthalmoscope bulb 2.5V	<b>31446</b>	Parker ophthalmoscope Parker diagnostic sets
 Xenon halogen bulb for otoscope 2.5V	<b>31478</b>	Gimalux otoscopes, Kawe and Riester mini otoscopes Compatible for products that use Heine bulb #037
 Halogen bulb for ophthalmoscope and dermatoscope 2.5V	<b>31479</b>	Parker halogen ophthalmoscope
 Xenon halogen ophthalmoscope bulbs 3.5 V	<b>31428</b>	Gima Xenon - halogen diagnostic sets - ophthalmoscope
<b>OTO-OPHTHALMO-DERMATOSCOPE BULBS - OTHER COUNTRIES</b>		
 Halogen Dermatoscope bulb 2.5 V	<b>31188</b>	Gima dermatoscope Compatible for products that use Heine Bulb #038
 Xenon halogen otoscope bulbs 3.5 V	<b>31427</b>	Gima Xenon - halogen diagnostic sets - otoscope

# HEINE MINI 3000® XHL AND LED<sup>HQ</sup> OTO AND OPHTHALMOSCOPE



## MINI 3000 F.O. XENON OTOSCOPES

Powerful pocket otoscope in a unique compact design.

- **Xenon halogen** bulbs for bright illumination and accurate colour rendering.
- **20,000 on/off switch cycles** guaranteed
- **distal Fiber Optic (F.O.) illumination:** Reflex-free illumination of tympanum and ear cana.
- **viewing window with 3X magnification and optimized casing surface** for razor-sharp images and minimal reflection. **Swivelling viewing window built into instrument.**
- **pneumatic testing** of the tympanum mobility by using the insufflation port and an optional connector
- **attachment clip with integrated on/off switch**
- **replaceable batteries:** size AA or optional rechargeable battery (31693) with mini NT table charger (31692).
- **2-piece handle and head.** Easy to maintain, flexible. Compatible with other handles.

## MINI 3000 F.O. LED<sup>HQ</sup> OTOSCOPES

All features of F.O. Xenon otoscopes with the addition of:

- **maintenance-free**, no need to ever change the LED
- LED thermal management for a **consistent light output throughout the whole working life**
- High-performance-LED: bright and absolutely homogeneous illumination with **excellent colour rendering** - colour temperature 4,000°K, colour rendering index >95, and >90 rendering index of the colour red
- **twice as bright** as Xenon Halogen instruments
- **exclusive Battery Performance Indicator**
- **exclusive fade-out function** reduces illumination intensity with battery level to let you know when to replace
- **operation time up to 10 hours**

	BLACK		BLUE	
	GIMA code	HEINE code	GIMA code	HEINE code
Standard	31680	D-001.70.210	31681	D-001.70.210
F.O. Xenon	31684	D-001.70.110	31685	D-001.70.110
F.O. LED <sup>HQ</sup>	31676	D-008.70.110	31677	D-008.70.110

MINI 3000 OTOSCOPE 2.5 V - RECHARGEABLE HANDLE**				
F.O. Xenon	31682	D-001.70.301	-	-
F.O. LED <sup>HQ</sup>	31683	D-008.70.301	-	-

Above otoscopes are supplied in a box with 5 disposable speculum Ø 4 mm and 5 Ø 2.5 mm

MINI 3000 OTOSCOPE 2.5 V - hard case				
F.O. LED <sup>HQ</sup>	31678	D-885.20.021	-	-

Supplied in hard case with 5 disposable speculum Ø 4 mm, 5 Ø 2.5 and 4 reusable speculum (Ø 2.4, 3, 4, 5 mm)

31503

Dispenser of 250 pcs.



31516

Box of 1,000 speculum



GIMA code	HEINE DISPOSABLE MINI EAR SPECULUM*	Minimum order
31501	HEINE dispenser for mini speculum - empty	-
31502	HEINE disposable Allspec® speculum Ø 2.5 mm - grey	dispenser of 250
31503	HEINE disposable Allspec® speculum Ø 4 mm - grey	dispenser of 250
31515	HEINE disposable Allspec® speculum Ø 2.5 mm - grey	box of 1000
31516	HEINE disposable Allspec® speculum Ø 4 mm - grey	box of 1000

\*Compatible with Heine Mini 2000/3000, K180, Beta 200, Beta 400

5 YEARS WARRANTY



## Ophthalmoscope with 5 different apertures

- **Large spot** for normal fundus examinations.
- **Small spot** to access small pupils.
- **Fixation star** for determination of central or eccentric fixation. Especially suited for examining children.
- **Hemispot** for reduced reflection with small pupils.
- **Red-free filter** for contrast-enhancement when assessing fine vascular disorders

## MINI 3000 XENON OPHTHALMOSCOPES

Modern pocket ophthalmoscope with fixation star aperture. Excellent optics and best colour rendering in minimum size.

- **XHL Xenon Halogen Technology.** Concentrated bright light for perfect illumination, a brilliant image and accurate colour rendering
- **the HEINE optics produce crisp, clear images of the whole area under examination** and minimize the reflections
- **5 different apertures.** A full-function instrument incl. fixation star
- **grey filter** for light sensitive patients
- **range of lenses: 18 lenses from -20 D to +20 D**
- **easy workflow**, because ophthalmoscopy is possible without dilation of the pupils
- **attachment clip with integrated on/off switch**
- **replaceable batteries.** Size AA or optional rechargeable battery (31693) with mini NT table charger (31692).

## MINI 3000 LED<sup>HQ</sup> OPHTHALMOSCOPES

All features of Xenon ophthalmoscope with the addition of:

- **maintenance-free**, no need to ever replace the LED.
- LED thermal management for a **consistent light output throughout the whole working life.**
- high-performance-LED: bright and absolutely homogeneous illumination with an **excellent colour rendering** - colour temperature 4,000°K, colour rendering index >95, and >90 rendering index of the colour red.
- **exclusive battery performance indicator**
- **exclusive fade-out function** reduces illumination intensity with battery level to let you know when to replace.
- **operation time up to 10 hours.**

	MINI 3000 OPHTHALMOSCOPES 2.5 V			
	BLACK		BLUE	
	GIMA code	HEINE code	GIMA code	HEINE code
Xenon	31686	D-001.71.120	31687	D 001.71.120
LED <sup>HQ</sup>	31688	D-008.71.120	-	-
MINI 3000 OPHTHALMOSCOPES 2.5 V - RECHARGEABLE HANDLE**				
F.O. Xenon	31694	D-001.71.200	-	-
F.O. LED <sup>HQ</sup>	31695	D-008.71.200	-	-
MINI 3000 OTO-OPHTHALMO SET - hard case				
Xenon Set	31689	D-873.11.021	-	-
LED <sup>HQ</sup> Set	31696	D-886.11.021	-	-

Both set (Xenon or LED) include one F.O. otoscope head, one ophthalmoscope head, 2 handles, 4 reusable specula (Ø 2.4, 3, 4, 5 mm), 5 disposable specula Ø 4 mm and 5 Ø 2.5 mm in hard case.

NiMH rechargeable battery with bottom insert for Mini 3000 handles.

31693



31692

GIMA code	HEINE code	CHARGER AND ACCESSORIES
31691	D-000.80.101	MINI 3000 connector for pneumatic test
31692	X-001.99.484	HEINE MINI 3000 NT charger
31693	X-001.99.487 + X-001.99.488	BATTERY + BASE

\*\*Need Heine Mini 3000 NT charger (31692)

# SIGMA F.O. XENON OR LED OTO AND OPHTHALMO SETS

High quality pocket diagnostic instruments designed for professional use in ENT and ophthalmology. Light weight and manufactured from impact resistant re-enforced plastic. Supplied in deluxe rigid plastic case or pouch with multilingual manual (GB, FR, IT, ES, PT, DE, GR, PL, RO, Arabic). Sigma otoscopes are compatible with Gima mini speculum (31485-8, 31491-2, 31495-9).

### Sigma otoscopes

High quality materials and top-notch workmanship ensure excellent reliability in every examination.

- swivel type window with 3X magnification lens for sharp images and minimal reflection
- distal fibre optic illumination with super bright Xenon/Halogen or LED light
- insufflation port for pneumatic testing of tympanic mobility (optional connector port 31532 and insufflation bulb 31483)

- standard or rechargeable handle. Optional metal endcap (31588) can convert any standard Sigma handle into rechargeable version.

### Sigma ophthalmoscopes

High quality optics in mini format makes this instrument ideal for house calls and rounds.

- super bright Xenon-Halogen or LED light
- 5 different apertures for almost all ophthalmic examinations
- range of lenses from -20 D to +20 D

+	1	2	3	4	6	8	10	15	20
-	1	2	3	4	6	8	10	15	20

Colour coded 18 lenses for excellent resolution

- Large spot:** for normal funduscopy
  - Small spot:** for reduced reflection with small pupils
  - Semi circle:** for reduced reflection with small pupils
  - Fixation star:** for determination of central or eccentric fixation, suitable for children
  - Red-free filter:** for contrast-enhancement when assessing fine vascular disorders
- Rechargeable battery 31587 Metal endcap 31588

SIGMA F.O. OTOSCOPES AND OPHTHALMOSCOPES 2.5V - standard handle					
OTOSCOPES*			OPHTHALMOSCOPES		
Black	Blue	Purple	Black	Type	Packing
31524	31523	31511	31530	Xenon-Halogen	Pouch
31525	-	-	31527	Xenon-Halogen	Case
31513	-	-	-	LED	Pouch
31526	31518	-	31529	LED	Case
SIGMA F.O. LED OTOSCOPE AND OPHTHALMOSCOPE 2.5V - rechargeable** handle with battery					
31580	Otoscope with rechargeable handle and battery - black			LED	Pouch
31582	Ophthalmoscope with rechargeable handle and battery - black			LED	Pouch

\*Otoscopies are supplied with 14 disposable specula (7 with Ø 2.5 mm, 7 with Ø 4 mm)

\*\*Rechargeable handle can be used with "AA" standard batteries or rechargeable battery code 31587 (needs charging station code 31586) Full battery charge in 2.5 hours. Can be connected to PC or laptop via standard USB (Type C) cable (not included)

GIMA code	SIGMA F.O. OTO-OPHTHALMOSCOPE SETS*** 2.5V - black	Type	Packing
31533	Oto-ophthalmoscope set with 1 handle	Xenon-Halogen	Case
31528	Oto-ophthalmoscope set with 2 handles	Xenon-Halogen	Case
31534	Oto-ophthalmoscope set with 2 handles	LED	Case
31584	Oto-ophthalmoscope set with 2 rechargeable handles and batteries	LED	Case

\*\*\*Oto-ophthalmo sets are supplied with oto and ophthalmo head, 1 handle (31533) or 2 handles (31528, 31534, 31584), 14 disposable specula (7 with Ø 2.5 mm, 7 with Ø 4 mm), 2 rechargeable batteries (31584)

GIMA code	SPARES AND ACCESSORIES	GIMA code	CHARGING SYSTEM
34485	Otoscope bulb - Xenon-Halogen 2.5 V	31586	Charging station
31531	Ophthalmoscope bulb - Xenon-Halogen 2.5 V	31587	Rechargeable battery
31532	Pneumatic connector port	31588	Metal endcap
31483	Insufflation bulb		



31527,  
31530,  
31529

31513,  
31524,  
31525,  
31526

FIBRE OPTIC  
OR F.O. LED



31511



31518



31527,  
31529



31533



31528,  
31534, 31584



31586  
Charging station

# SIGMA-C LED OTOSCOPES

- 31591 SIGMA-C LED OTOSCOPE - black - pouch
  - 31592 SIGMA-C LED OTOSCOPE - blue - pouch
  - 31593 SIGMA-C LED OTOSCOPE - purple - pouch
  - made of light weight impact resistant re-enforced plastic and highly corrosion resistant stainless steel material for exterior finish
  - swivel type window with 3X magnification lens for sharp image and minimal reflection
  - optional insufflation port for pneumatic testing of tympanic mobility (needs codes 31532 and 31483)
  - compatible with Gima ear specula 31485-8, 31491-2, 31495-9
  - 50.000 hours lifetime
  - extended battery life of 50 hours
  - colour temperature 4,300 K, CRI>95 ensures real colour.
- Multilingual manual: GB, FR, IT, ES, PT, DE, GR, RO, PL, Arabic.



31591

31592

31593

31591

LED

## E-SCOPE®: RIESTER OTO-OPHTHALMOSCOPES

- 31548 E-SCOPE® OTOSCOPE - HALOGEN 2.7V - black in pouch
- 31549 E-SCOPE® OTOSCOPE - XENON 2.5V - white in pouch
- 31550 E-SCOPE® OTOSCOPE - XENON 2.5V - black in pouch
- 31552 E-SCOPE® F.O. OTOSCOPE - LED 3.7V - white in rigid case
- 31553 E-SCOPE® F.O. OTOSCOPE - LED 3.7V - black in rigid case

Halogen, direct Xenon or F.O. LED illumination otoscopes. Sealing precision optics pivoting to both sides with triple magnification for superior view

Dioptr adjustment wheel  
CE  
Dioptr display  
Aperture wheel (back)  
3X magnifying pivoting lens  
Reusable speculum (for disposable speculum see page 265-266)

**INNOVATIVE LED 3.7 V ILLUMINATION:**

- real colour 5,500K white light
- long life LED bulbs: up to 20,000 hours
- low battery consumption: up to 50 hours operation through IPC (Integrated Power Converter). It converts the voltage of AA batteries into the optimum voltage required for LED

Bulb life	Battery life (2 x alkaline)
20000 h	50 h
20 h	3 h

Xenon LED      Xenon LED

Fixation bar

Large circle

Small circle

Red free filter

Blue filter

Semi circle

31556

31552

Suitable for performance of pneumatic tests (supplied without connector and insufflator)

- 31556 E-SCOPE® OPHTHALMOSCOPE - XENON 2.5 V - black - in rigid case
- 31557 E-SCOPE® OPHTHALMOSCOPE - F.O. - LED 3.7 V - white - in rigid case
- 31559 E-SCOPE® OPHTHALMOSCOPE - F.O. - LED 3.7 V - black - in rigid case

E-scope ophthalmoscopes are available with Xenon or LED illumination.

- with 2.5V Xenon or innovative 3.7V LED illumination for higher-contrast and more efficient diagnosis
- dioptr disc with 18 corrective lenses (± 1, 2, 3, 4, 6, 8, 10, 15, 20)
- easy-to-use aperture wheel with six apertures (fixation star, large circle, small circle, red free filter, blue filter, semi circle)
- high performance optics with aspherical condenser
- spectacle protection
- parallel optical path

MADE IN GERMANY

- 31558 E-SCOPE® DIAGNOSTIC KIT - white
- 31564 E-SCOPE® DIAGNOSTIC KIT - black

Oto-ophthalmoscope sets, LED 3.7V, in rigid case.

- 31560 E-SCOPE® OTOSCOPE - XENON 2.5 V BULB
- 31561 E-SCOPE® OTOSCOPE - LED 3.7 V BULB
- 31562 E-SCOPE® OPHTHALMOSCOPE - XENON 2.5 V BULB
- 31563 E-SCOPE® OPHTHALMOSCOPE - LED 3.7 V BULB
- 31817 RIESTER® EAR SPECULUM Ø 2.5 mm - autoclav. - box of 10
- 31819 RIESTER® EAR SPECULUM Ø 4 mm - autoclav. - box of 10
- 31566 E-SCOPE® EAR SPECULUM Ø 2.5 mm - disposable - box of 100
- 31567 E-SCOPE® EAR SPECULUM Ø 4 mm - disposable - box of 100

## LUXAMED AURIS LED OTOSCOPES

LED-Ring Technology, with 6 LED

31572  
USB port (31572 only)

- 31570 LUXAMED AURIS LED 2.5V OTOSCOPE - black
- 31571 LUXAMED AURIS LED 2.5V OTOSCOPE - blue
- 31572 LUXAMED AURIS LED 3.7V USB OTOSCOPE - black

Innovative otoscopes that combine best handcraft production with selected materials with the most modern technology. Two-components handle (aluminium/fibre-glass reinforced) with electronic ON/OFF switch and dimmer.

Features:

- LED-Ring illumination with 6 LEDs (concentric), no fibre optic. The functionality is not affected (patent DE202013104278U1) if a single LED fails.
- automatic switchoff after 3 minutes
- approx. 100,000 hours life expectancy of LEDs
- approx. 10,000 Lux intensity of illumination
- approx. 4,000 K colour temperature
- pivoting 3-fold magnifying glass with locking function
- insufflation port for pneumatic test.

Supplied with 2xAAA alkaline batteries (31570/1) or lithium-ion rechargeable battery 3.7V (31572) 20 disposable ear funnels (10x2.5 mm and 10x4.0 mm) and manual (GB, IT, DE). See page 266 for compatible ear speculum.

MADE IN GERMANY

31572

Recharger with USB plug - 3 adapters (EU, UK, US)

259



## RIESTER ELITEVUE



Supplied in a case with specula

EliteVue LED otoscope

31863

**Riester**  
MADE IN GERMANY

31860

- 31860 RIESTER ELITEVUE LED OTOSCOPE 3.5 V - 2200-203
  - 31863 RIESTER ELITEVUE LED OTO-OPHTHALMO L2 SET 3.5 V with C-handle for rechargeable Li-Ion battery - 2210-203
- EliteVue offers twice the field of view and 66% greater magnification (at 15 mm distance) compared to standard otoscopes. Improved view of auditory canal and tympanic membrane guarantees more efficient diagnosis. Suitable for throat illumination. 4,000 K LED illumination (CRI: 92). 5X magnification.
- 31840 RI-CHARGER L 230 V - 10705
  - 31841 RI-ACCU L 3.5 V Li-Ion BATTERY for "C" size - 10691

## HEINE K180 OTO-OPHTHALMO



5 YEARS WARRANTY



MADE IN GERMANY

31740

- 31740 HEINE K180 - F.O. OTO-OPHTHALMO SET - 2.5 V - A-279.10.118
- Otoscope and ophthalmoscope K180 with BETA battery 2.5 V handle and a set of single use specula. Supplied in hard case.
- 31782 HEINE 084 OPHTHALMO BULB 2.5 V - spare - X-001.88.084
  - 31772 HEINE 077 OTOSCOPE BULB - spare - X-001.88.077
  - 31741 HEINE K180 OPHTHALMOSCOPE - 2.5 V C-182.10.118
- 28 lenses from -35D to +40D supplied in pouch



## HEINE BETA 200 F.O. OTOSCOPES



31725  
31728

Large, scratch-resistant glass viewing window with 3x magnification

34449

BETA 200, BETA 400 OTOSCOPE HEAD

Distal fiber optic (F.O.) illumination with XHL xenon halogen technology

Handle with charge status display

31728+34374

- 31725 HEINE BETA 200 F.O. OTOSCOPE - 2.5V - B-141.10.118
- F.O. Otoscope with BETA battery 2.5V handle with rheostat, a set of single use specula, a set of reusable specula and a spare bulb. Supplied in hard case. Solid all metal construction, a quality instrument with fibre optic illumination.
- 31772 HEINE 077 OTOSCOPE BULB - spare - X-001.88.077
  - 31784 HEINE 078 OTOSCOPE BULB - X-002.88.078

MADE IN GERMANY

- 31728 HEINE BETA 400 LED F.O. OTOSCOPE - B-143.24.420
- Exclusive 4.2X magnification. LED in HQ with continuous brightness control. All metal housing and scratch resistant glass lenses. Colour temperature: 3,500 K. Colour rendering index (CRI) >97. Exceptional depth of field, provides sharp spatial image. LED otoscope with rechargeable handle supplied with 4 reusable speculum, 5 of both All Spec disposable speculum 2.5 and 4 mm Ø in a case with NT4 table charger (34374).

## HEINE BETA 200 AND 200S OPHTHALMOSCOPES

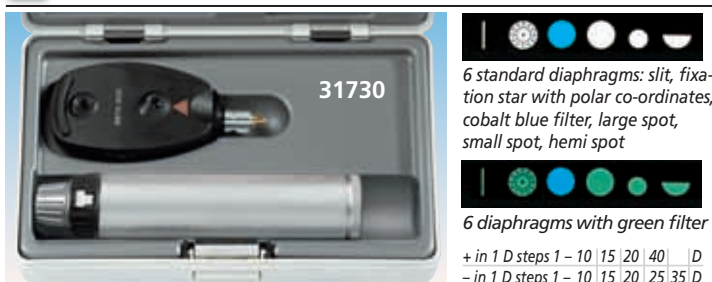

31730

6 standard diaphragms: slit, fixation star with polar co-ordinates, cobalt blue filter, large spot, small spot, hemi spot

6 diaphragms with green filter

+ in 1 D steps 1 - 10 15 20 40 D  
- in 1 D steps 1 - 10 15 20 25 35 D

- 31730 HEINE BETA 200 HALOGEN OPHTHALMOSCOPE - 2.5 V - C-144.10.118
- The unique aspherical optic system eliminates corneal and iris reflexes. The illuminated area of the retina remains fully visible even in case of small pupil (bright light). BETA 200 has 6 diaphragms with separately "green filter". It is recommended for slit or fluorescent ophthalmoscopy as well as for fixation test. Range -35D to +40D. Supplied in hard case with replacement bulb.
- 31731 HEINE BETA 200 F.O. OPHTHALMOSCOPE - 3.5 V Li-ion - C-144.27.388
- Same as 31730 but with USB rechargeable handle for mains socket and Li-ion batteries.
- 31783 HEINE 070 OPHTHALMOSCOPE BULB 3,5 V - X-002.88.070



31730

- 31735 HEINE BETA 200S OPHTHALMOSCOPE - 2.5 V - C-261.10.118
- 31781 HEINE 069 OPHTHALMO BULB - 2.5 V - spare - X-001.88.069
- 31737 HEINE BETA 200S LED OPHTHALMO - 3.5 V with USB rechargeable handle - C-261.28.388

Superior aspherical optics and 74 single-diopter steps - optical system: corneal and iris reflexes are eliminated. A full view is guaranteed even with small pupils.

- XHL (Xenon Halogen Technology) or LED: bright, white light.
- recessed, multi-coated viewing window: avoids stray light.
- optics mounted on precision metal chassis.
- ergonomic shape: instrument fits the orbita comfortably in any position.
- 7 apertures with separate red-free filter:
- lens range: perfect focus even with high refractive errors.
- exact colour rendering both with XHL and LED illumination

MADE IN GERMANY



Cobalt blue filter, fixation star with polar co-ordinates, large spot, small spot, pinhole, slit, hemislot



With red-free filter: Cobalt blue filter, fixation star with polar coordinates, large spot, small spot, pinhole, slit, hemislot



74 single diopters steps + in 1 D steps: +1 through +38 D - in 1 D steps: -1 through -36 D

# VISIO 5 PLUS WALL DIAGNOSTIC STATION 3.5 V - XENON OR LED

## VISIO 5 PLUS WALL DIAGNOSTIC STATION 3.5 V

Modern design diagnostic station to satisfy all practitioners and clinics needs. Available with two configurations:

- oto-ophthalmoscope with disposable ear tip dispenser
  - ophthalmoscope only.
- Two illumination technologies: LED or Xenon-Halogen. Regulated output prolongs the bulb life and guarantees optimal light intensity.
- ergonomic designed non-slip handles
  - constant output transformer with integrated surge protection
  - soft start technology to introduce voltage gently, eliminates cold-shock when turning ON increasing bulb life
  - automatic ON-OFF switch once the handle is removed or replaced in the cradle
  - adjustable light intensity, low power consumption
  - precise brightness control, between 3 and 100%
  - spiral cord of 3 meters when stretched
- Supplied with multilingual manual: GB, FR, IT, ES.

### TECHNICAL SPECIFICATIONS OPHTHALMOSCOPES

	31620-1-2	31623
Apertures	7	8
Focusing lenses	28	68
Diopters range	-20 to +40	-30 to +38

**Visio 5XE Plus additional features (31623)**

- Coaxial optics for easier examination of undilated pupils
- Detection of corneal abrasions with cobalt blue filter
- Polarizing filter to virtually eliminate corneal reflection



APERTURES/ FILTER DIAL	
Small light	•
Medium light	•
Large light	•
Blue light*	•
Grid	•
Slit	
Half light	•
Red free light	•

\*5XE (31623 only)

GIMA code	VISIO 5 PLUS DIAGNOSTIC STATION
31620	Visio 5GE Plus oto-ophthalmo diagnostic station* - Xenon
31621	Visio 5GE Plus oto-ophthalmo diagnostic station* - LED
*Include power transformer, 2 handles, oto/ophthalmo heads, dispenser with 100 disposable grey speculum (50 Ø 2.5 mm, 50 Ø 4 mm), wall board for easy mounting or removal of diagnostic station.	
31622	Visio 5GE Plus ophthalmoscope diagnostic station - LED
31623	Visio 5XE Plus ophthalmoscope diagnostic station - LED
31428	Xenon bulb for ophthalmoscope - spare
31544	Xenon bulb for otoscope - spare
31485	Disposable mini ear speculum Ø 2.5 mm - grey - box of 100
31486	Disposable mini ear speculum Ø 4 mm - grey - box of 100

# VISIO 2000 F.O., XENON OTO, OPHTHALMO, ENT SETS - 3.5 V

Professional diagnostic sets with fiber optic illumination, Xenon light 3.5 V, rheostat to adjust the intensity of light. Made of resistant re-inforced plastic and durable easy locking system.

Supplied in deluxe case, should be used with charging station 31542 and Li-ion rechargeable battery 31541. Only plug-in set (31537) has direct AC connection and included battery (31547).

- 31535 VISIO 2000 F.O. XENON OTOSCOPE - 3.5 V
- 31536 VISIO 2000 F.O. XENON OPHTHALMOSCOPE - 3.5 V
- 31537 VISIO 2000 F.O. XENON OTO-OPHTHALMOSCOPE

### PLUG-IN SET - 3.5 V - 2 pin plug

- 31538 VISIO 2000 F.O. XENON OTO-OPHTHALMOSCOPE - 3.5 V
- 31539 VISIO 2000 F.O. XENON DIAGNOSTIC SET - 3.5 V
- 31428 OPHTHALMOSCOPE BULB - spare
- 31544 OTOSCOPE BULB - spare
- 31541 LI-ION RECHARGEABLE BATTERY 3.5 V
- 31547 LI-ION RECHARGEABLE BATTERY 3.5 V for PLUG-IN HANDLE SET 31537- spare

- 31542 ZOOM CHARGING STATION
- Supplied with EU 2 pin, UK and US plug

### MINI EAR SPECULUM

Visio otoscopes are compatible with Gima speculum (31485-8, 31491-2, 31495-9). See page 266

Swivel type window with 3X magnification for sharp images and minimal reflection



6 apertures to select:



0	1	2	3	4	5	6	7	8	9	10	12	15	20	40
1	2	3	4	5	6	7	8	9	10	15	20	25		

Colour coded 28 lenses for perfect examination (GREEN for +, RED for -)



31535

**F.O. Xenon otoscope set 3.5 V**  
F.O. otoscope head, battery handle with bayonet lock, 1 set of 5 reusable eartips (2.5, 3.0, 4.0, 5.0 & 10.0 mm), tube of 14 disposable eartips (2.5 & 4.0 mm), spare bulb, in a rigid case.

**F.O. Xenon ophthalmoscope set 3.5 V**  
31536 F.O. ophthalmalmo head, battery handle with bayonet lock, spare bulb, in a rigid case.



31537

**F.O. Xenon oto/ophthalmo plug-in set 3.5 V**  
F.O. otoscope head, F.O. ophthalmalmo head, battery handle with bayonet lock and plug-in, 1 set of 5 reusable eartips (2.5, 3.0, 4.0, 5.0 & 10.0 mm), tube of 14 disposable eartips (2.5 & 4.0 mm), spare oto and ophthalmalmo bulbs, rechargeable Li-ion battery 31547, in a rigid case.



Plug-in handle



31538

**F.O. Xenon oto/ophthalmo set 3.5 V**  
F.O. otoscope head, F.O. ophthalmalmo head, 2 battery handles with bayonet lock, nasal illuminator with F.O. light, 1 set of 5 reusable eartips (2.5, 3.0, 4.0, 5.0 & 10.0 mm), tube of 14 disposable eartips (2.5 & 4.0 mm), spare oto bulb, suitable also for nasal illuminator, and ophthalmalmo bulb, in a rigid case.



31539

**F.O. Xenon ENT diagnostic set 3.5 V**  
F.O. otoscope head, F.O. ophthalmalmo head, battery handle with bayonet lock, nasal illuminator with F.O. light, curved illuminator with bulb, plain mirror 20.0 mm, plastic tongue depressor, 1 set of 5 reusable eartips (2.5, 3.0, 4.0, 5.0 & 10.0 mm) tube of 14 disposable eartips (2.5 & 4.0 mm), spare oto and ophthalmalmo bulbs, in a rigid case.

# RI-FORMER® THE MODULAR DIAGNOSTIC STATION 3.5V



## RI-FORMER MODULAR DIAGNOSTIC STATION

The modular diagnostic station can be individually combined according to requirements and the room situation, it is variably extendable to the right and the left.

The basic Ri-former® module is available with one handle and can be supplemented with up to 4 further handle modules.

- 3.5V Xenon or LED illumination creates lighting conditions similar to daylight
- optimum electronic efficiency using an adjustable dimmer
- constant output voltage independent from the mains supply prolongs the service life of the lamps and guarantees optimum light intensity
- automatic switching on/off of handles when removing or replacing them in the handle unit saves energy and increases the service life of the lamps
- non-slip, ergonomically designed handles with rheostat: infinitely variable regulation of brightness as well as manual switching on/off possible on the handle
- spiral cord expandable up to 3 m



GIMA code	MODULAR DIAGNOSTIC STATION - XENON
31800	Ri-Former Diagnostic station 3.5-230V* 50/60 Hz-standard (include 2 handles oto and ophthalmoscope head, ear specula dispenser, clock)
31805	Ri-Former Diagnostic station 3.5-230V* 50/60 Hz-large (include 31800 + sphygmo) *available on request 120V - 50/60 Hz
MODULAR DIAGNOSTIC STATION - LED	
31801	Ri-Former Diagnostic station 3.5-230V* 50/60 Hz-standard (include 2 handles, LED oto and ophthalmoscope head, ear specula dispenser, clock)
31806	Ri-Former Diagnostic station 3.5-230V* 50/60 Hz-large (include 31801 + sphygmo) *available on request 120V - 50/60 Hz
RI-FORMER MODULES AND HEADS	
31809	Basic diagnostic station 1 handle 3.5 - 230V* 50/60 Hz
31810	Extension module 1 handle
31811	Ri-scope L2 otoscope head - Led 3.5V
31812	Ri-scope L1 otoscope head - Xenon 3.5V
31813	Ri-scope L1 ophthalmoscope head - Xenon 3.5V
31814	Ri-scope retinoscope head - Xenon 3.5V
31815	Ri-scope dermatoscope head - Led 3.5V
31817	Ri-scope L1, L2 ear speculum Ø 2.5 mm - autocl. 134°C - box of 10
31819	Ri-scope L1, L2 ear speculum Ø 4 mm - autocl. 134°C - box of 10
31827	Ri-scope L1, L2 ear speculum Ø 2.5 mm - disposable - box of 100
31828	Ri-scope L1, L2 ear speculum Ø 4 mm - disposable - box of 100
31820	Ri-spec ear specula dispenser - specula not included
31822	Sphygmomanometer with basket
31823	Ri-thermo N infrared thermometer with 40 covers
31824	Probe cover for 31823 - box of 100 - spare
31825	Xenon L1 otoscope bulb 3.5V - spare
31826	Xenon ophthalmoscope L1, L2, L3 bulb 3.5V - spare

\*Available on request 120V - 50/60 Hz



## RI-SCOPE® L: LED + Li-ion BATTERIES

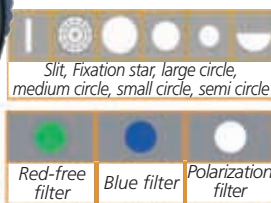

**LED illumination: bright, white light with a nearly unlimited lifetime!** With its monochromatic white light (4,000° Kelvin) the lamp in the ri-scope®L provides cold light and true-colour. CRI > 90. Lamps with LED technology have a lifetime of at least 10,000 hours (compared to 20-30 hours with halogen and Xenon lamps) and are extremely energy-efficient.

### Li-ion batteries for great power

Higher charging capacity, longer lifetime, light-weight are the big advantages of Li-ions batteries. High performance for up to 1200 charging cycles. LEDs powered by lithium batteries can burn for up to 50 hours.

- 31829 RI-SCOPE L LED OTOSCOPE L2 - 2,5 V - AA handle - 3708
- 31830 RI-SCOPE L LED OTOSCOPE L2 - 3,5 V - C handle - 3703-550

Ri-scope®L otoscopes with optical glass and reduced reflection combine excellent optical properties and unparalleled performance with the reliability and efficiency of LED/lithium-ion technology (31830 only).

- optimal beaming and transmission of the light.
- bi-directional swivelling, sealing optical glass 3X
- Suitable for pneumatic test (supplied without ball).
- C handle runs Li-ion batteries, not included.

Supplied in deluxe hard case with one spare lamp, 4 reusable and 3 disposable ear specula.

Spare ear speculum: original 31817-31819 (autoclavable) or 31827 - 31828 (disposable). Compatible 31485 to 31499 (disposable) page 266

### • 31832 RI-SCOPE L2 XENON OPHTHALMOSCOPE - 3,5 V

Enhanced basic model with separately engageable red-free, blue and polarization filters for each aperture.

- Diopter wheel with 29 corrective lenses Plus 1-10, 12, 15, 20, 40 Minus 1-10, 15, 20, 25, 30, 35

- Easy-to-operate aperture hand-wheel with semi-circle, small/medium/large circle, fixation star, and slit
- Includes filter wheel engageable for all apertures with symbol display, red-free filter, blue filter and polarization filter

### • 31834 RI-SCOPE L LED OTOSCOPE L2 + XENON OPHTHALMOSCOPE L2 3.5 V - C handle

- 31826 XENON L1/L2/L3 OPHTHALMOSCOPE BULB 3,5 V - spare
- 31841 RI-ACCU L 3.5 V Li-ion BATTERY

for "C" size - 10691

- 31840 RI-CHARGER L 230 V



Table recharge station (with wall holder) recharge 2 "C" handles with Li-ion batteries.



31840

# GIMA OTOSCOPES: PARKER LINE

VETERINARY OTOSCOPES AND SETS SEE PAGE 441-442



31442

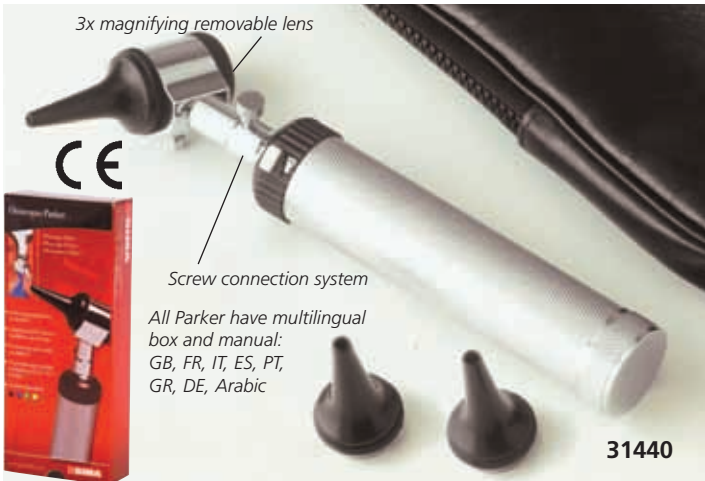

31440

All Parker have multilingual box and manual: GB, FR, IT, ES, PT, GR, DE, Arabic



31437

31436

BAYONET CONNECTION SYSTEM

31435

## PARKER OTOSCOPES

- reliable and indestructible high quality instrument
- suitable for everyday ear nose and throat examinations
- easily adjustable 2.5 V vacuum light (made in Germany)
- quality 3 times magnifying lens
- available with Plug in and snap (bayonet locking) or knurled screw type otoscope heads
- ideal for pneumatic tympanic membrane tests, can also be used for rhinoscopic examinations
- supplied with 3 autoclavable ear funnels in a colour coordinated zip bag.
- All latex free.
- require 2xC batteries (not included) 31542
- 31441 also works with rechargeable battery



GIMA code	PARKER OTOSCOPES	Connection system	Ear Funnels
31435	Parker colour - green	Bayonet	Ø 2.5, 3.5, 4.5 mm
31436	Parker colour - blue	Bayonet	Ø 2.5, 3.5, 4.5 mm
31437	Parker colour - yellow	Bayonet	Ø 2.5, 3.5, 4.5 mm
31440	Parker - black	Screw	Ø 2.5, 3.5, 4.5 mm
31441	Parker with rechargeable handle	Bayonet	Ø 2.5, 3.5, 4.5 mm
31442	Parker veterinary - black	Screw	Ø 4, 5, 7 mm
31449	Spare bulb 2.5 V for Parker otoscopes 31435-6-7,31440-1-2		
31542	Charging station for 31441		
34467	Rechargeable Li-ion battery 2.5 V / 2,200 mAh		

# PARKER DIAGNOSTIC SETS

- **31471 PARKER DIAGNOSTIC SET**  
Lightweight, semi rigid nylon case with one Parker otoscope 2.5 V with rechargeable handle, 3 autoclavable ear speculum (Ø 2.5, 3.5 and 4.5 mm), 2 laryngeal mirrors (size 3 and 4), bent arm throat lamp, tongue spatula, adjustable nasal speculum.
- **31473 PARKER LARGE SET WITH OPHTHALMO**  
Same as code 31471 with an ophthalmoscope head, support for single use tongue depressors and 1 tube of 14 single use specula (7x Ø 2.5, 7x Ø 4 mm).
- **31446 VACUUM BULB FOR OPHTHALMOSCOPE**
- **31449 VACUUM BULB FOR OTOSCOPE**
- **32203 "C" ALKALINE BATTERIES - blister of 2 pcs**
- **34467 RECHARGEABLE LI-ION BATTERY 2.5 V - needs 31542**

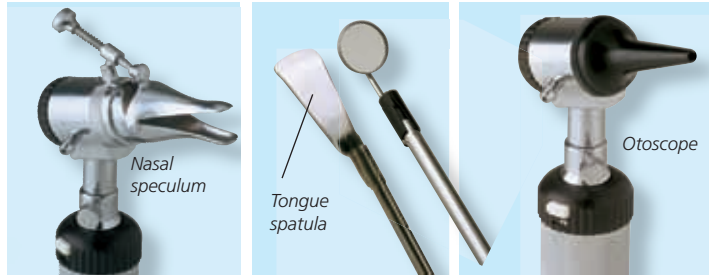

Nasal speculum

Tongue spatula

Otoscope



Ophthalmoscope head

CE

Tongue spatulae

Reusable Ear tips

Nasal specula

Wooden tongue depressor holder

Bent arm throat lamp/ Laryngeal mirror holder

Rechargeable handle for use with 2xC batteries or rechargeable battery

Otoscope

1 tube of single use specula

31473

Laryngeal mirrors

# LED OTOSCOPE - PEN LIGHT

- **31300 COMBI SET**  
Dual function instrument features convertable diagnostic pen light and mini-otoscope with 3 different sizes (2.5, 3.5, 4.5 x 38 mm) of funnels or specula. White Led light. Packed in a gift box. Pupil gauge and dual slide rule printed on the penlight. Supplied with batteries (2xAAA).
- **32200 "AAA" ALKALINE BATTERIES - blister of 4 pcs**
- **31345 REUSABLE EAR SPECULUM 2.5 mm - bag of 25**
- **31346 REUSABLE EAR SPECULUM 4.5 mm - bag of 25**



CE

31300

## XENON-HALOGEN OTO AND OPHTHALMOSCOPE SET



Rechargeable handle for use with 2xC batteries or rechargeable battery (34467)

31475

• **31475 XENON-HALOGEN PARKER OTOSCOPE**  
Same as PARKER Otoposcope code 31440 but with halogen 2.5V bulb, and bayonet connection system. Supplied with 3 autoclavable ear funnels in a soft bag. Requires 2xC batteries (not included) or rechargeable battery.

• **31474 HALOGEN OPERATIVE PARKER OTOSCOPE**  
Same as 31475 but with operative head.

• **31476 HALOGEN PARKER OPHTHALMOSCOPE**  
2.5V halogen light for true tissue colour and consistent, long lasting illumination 24 colour coded lenses -25 to +40 dioptres for excellent resolution (green for +, red for -). Rubber eye brow rest to prevent scratching of eye-glasses. Illumination lens dial for clear identification of dioptre setting.

• **31477 HALOGEN OTO-OPHTHALMOSCOPE PARKER SET**  
Diagnostic set including one handle, one halogen otoscope head and one halogen ophthalmoscope head, all in a plastic case.

- **31478 XENON-HALOGEN BULB FOR OTOSCOPE 2.5V**
- **31479 XENON-HALOGEN BULB FOR OPHTHALMOSCOPE 2.5V**
- **34467 RECHARGEABLE LI-ION BATTERY 2.5 V / 2,200 mAh**
- **31542 CHARGING STATION**
- **32203 "C" ALKALINE BATTERIES - blister of 2 pcs**



31474

31476

Supplied in a semi-rigid nylon bag with multilingual box and manual (GB, FR, IT, ES, PT, DE, GR, Arabic)



31477



31475



31476



+	1, 2, 3, 4, 5, 6, 8, 10, 12, 15, 20, 40
-	1, 2, 3, 4, 5, 6, 8, 10, 15, 20, 25

## XENON-HALOGEN DIAGNOSTIC SETS IN RIGID CASES

- **31480 XENON-HALOGEN DIAGNOSTIC SET - 3.5 V**
  - **31482 XENON-HALOGEN OPERATIVE DIAGNOSTIC SET - 3.5 V**
- Both xenon-halogen sets are supplied in plastic rigid case containing: one rechargeable handle, one otoscope head (operative for code 31482) one ophthalmoscope head, 3 autoclavable speculum Ø 2.5, 3.5, 4.5 mm, two laryngeal mirrors (size 3 and 4), adjustable nasal speculum, bent throat lamp, tongue spatula. Should be used with 31541 + 31542.
- **31427 XENON-HALOGEN OTOSCOPE BULB 3.5V**
  - **31428 XENON-HALOGEN OPHTHALMO BULB 3.5V**



Operative otoscope head

- **31542 CHARGING STATION - 100-240 V - 50/60 Hz**  
See details at page 261.
- **31541 RE-CHARGEABLE LI-ION BATTERY 3.5V\***

\*For handles sold after may 2013



31542



31480

## FIBRE OPTIC XENON-HALOGEN OTOSCOPES

- **31520 GIMALUX F.O. OTOSCOPE - black**
- **31521 GIMALUX F.O. OTOSCOPE - blue**
- **31522 GIMALUX F.O. OTOSCOPE - green**

High professional plastic otoscopes with extra bright halogen light provided by fibre optic system. Quality 3 times magnifying movable lens.

Output for pneumatic membrane test. Supplied with 14 single use mini speculums (7 Ø 2.5 and 7 Ø 4 mm) in a colour coordinated nylon bag. For mini ear-speculum see at page 266. All latex free.

- **34485 XENON-HALOGEN BULB 2.5V**  
Old model with chrome insufflation adapter need below bulb
- **31478 XENON-HALOGEN BULB 2.5V**  
for old models



Fibre optic system



Multilingual box and manual: GB, FR, IT, ES, PT, DE, GR, RO, HU, Arabic.



31521

31522





31520



## DISPOSABLE EAR-SPECULUM FOR "TRADITIONAL" OTOSCOPES

GIMA code	DISPOSABLE EAR - SPECULUM FOR OTOSCOPES OF DIFFERENT BRANDS	Colour	To be used with	Minimum order
31315	Disposable ear-speculum Ø 4 mm	Black	Riester (some models)	box of 200 pcs.
31504	Disposable ear-speculum Ø 2.5 mm	Black	Heine Beta 100, K100 and Eurolight,	box of 1000 pcs. (20 pack of 50)
31505	Disposable ear-speculum Ø 4 mm	Black	Kawe C10, C30, Combilight C10	box of 1000 pcs. (20 pack of 50)
31506	Disposable ear-speculum Ø 2.5 mm	White	Riester: Ri-star	dispenser of 250 pcs.
31507	Disposable ear-speculum Ø 4 mm	White		dispenser of 250 pcs.
31508	Disposable ear-speculum Ø 2.5 mm	Black	Welch Allyn: Pocket-pro; Pocket scope	dispenser of 250 pcs.
31509	Disposable ear-speculum Ø 4 mm	Black	Series 200, 250	dispenser of 250 pcs.

<p>Suitable for <b>RIESTER</b></p>  <p><b>31315</b></p>	<p>Suitable for <b>HEINE</b></p>  <p><b>31504-31505</b></p>	<p>Suitable for <b>RIESTER</b></p> <p>Multilingual box: GB, FR, IT, ES, PT, DE, GR, DK, Arabic.</p>  <p><b>31506-31507</b></p>	<p>Suitable for <b>WELCH-ALLYN</b></p> <p>Multilingual box: GB, FR, IT, ES, PT, DE, GR, DK, Arabic.</p>  <p><b>31508-31509</b></p>
--	--	--	---

## WELCH-ALLYN KLEENSPEC DISPOSABLE EAR SPECULUM

GIMA code	WELCH-ALLYN KLEENSPEC Disposable ear-speculum	Colour	To be used with	Minimum order
72570	KleenSpec ear-speculum Ø 3 mm	Black	Welch-Allyn 20100, 20200	box of 100 (4 packs of 25 pcs.)
72571	KleenSpec ear-speculum Ø 4 mm	Black	20202, 21600, 21700	box of 100 (4 packs of 25 pcs.)
32105	KleenSpec ear-speculum Ø 2.75 mm	Black	Welch-Allyn, Macroview	box of 850
32106	KleenSpec ear-speculum Ø 4.25 mm	Black	Riester Ri-scope L2, L3	box of 850

## ALKALINE, LITHIUM AND ZINC-AIR "ACOUSTIC" BATTERIES\*



FOR GENERAL USE APPLICATIONS

MADE IN GERMANY

FOR ACOUSTIC

GIMA code	VARTA ALKALINE LONG LIFE POWER BATTERIES	Type	Blister	GIMA code	RAYOVAC ZINC-AIR "ACOUSTIC BATTERIES" - mercury free	Blister
32200	Varta ministilo - alkaline	AAA	4 pcs.	32220	Rayovac 675 - zinc air - acoustic	6 pcs.
32201	Varta stilo - alkaline	AA	4 pcs.	32221	Rayovac 13 - zinc air - acoustic	6 pcs.
32203	Varta half torch - alkaline	C	2 pcs.	32222	Rayovac 312 - zinc air - acoustic	6 pcs.
32204	Varta torch - alkaline	D	2 pcs.	32223	Rayovac 10 - zinc air - acoustic	6 pcs.
32205	Varta 9V - alkaline	9V	1 pc.			

\*All batteries are made in Germany except 32205 (made in China)



FOR ELECTRONIC

GIMA code	VARTA INDUSTRIAL ALKALINE BATTERIES	Type	Box*	GIMA code	VARTA LITHIUM BATTERIES - BUTTON	Blister
32226	Varta Industrial ministilo - alkaline	AAA	10 pcs.	32210	Varta 2016 - lithium button	1 pc.
32228	Varta Industrial stilo - alkaline	AA	10 pcs.	32211	Varta 2025 - lithium button	1 pc.
				32212	Varta 2032 - lithium button	1 pc.

## RECHARGEABLE BATTERIES AND CHARGERS

GIMA code	VARTA POWER PLAY RECHARGEABLE BATTERIES	Type	Blister
32235	Varta ministilo - 1,000 mAh	AAA	2 pcs.
32236	Varta stilo - 2,600 mAh	AA	4 pcs.

GIMA code	CHARGERS FOR ANY BRAND***	Power supply	Sizes mm	Weight g	To be used with:	Recharging time	12V+USB adaptor
32241	Universal charger	100-240 V	172x109x53	403	AAA, AA, C, D, 9C	5 h	no
32238	LCD charger	110-240 V	72x116x32	170	AAA, AA	2 h	yes



\*\*\*Supplied without batteries

# GIMA DISPOSABLE EAR-SPECULUM FOR MINI OTOSCOPES OF DIFFERENT BRANDS

GIMA code	GIMA DISPOSABLE SPECULUM FOR MINI OTOSCOPES - LATEX FREE	Colour	Compatibility		Minimum order
			Direct fit	Fit with connector 31493	
31485	Disposable Mini ear-speculum Ø 2.5 mm - grey	Grey	Gima Gimalux, Sigma, Sigma C, Visio 5, Visio 2000 Heine mini 2000, 3000, K180/Beta 200/Beta 400 Riester Ri-Mini, Ri-scope L1-L2, E-scope, Pen-scope Kawe (Picolight, Combilight F030, Eurolight F030) Holtex Colson Luxamed	Gima: 31435-37, 31440-42, 31471, 31473, 31475, 31477, 31480, 31493 (Parker line)	dispenser of 250 dispenser of 250 dispenser of 250 dispenser of 250 pack of 100 pack of 100 box of 1,000 pack of 100 pack of 100 pack of 100
31486	Disposable Mini ear-speculum Ø 4 mm - grey	Grey			
31487	Disposable Mini ear-speculum Ø 2.5 mm - black	Black			
31488	Disposable Mini ear-speculum Ø 4 mm - black	Black			
31491	Disposable Mini ear-speculum Ø 2.5 mm - black	Black			
31492	Disposable Mini ear-speculum Ø 4 mm - black	Black			
31495	Disposable Mini ear-speculum mixed colours and Ø	Mixed			
31496	Disposable Mini ear-speculum Ø 2.5 mm - blue	Blue			
31497	Disposable Mini ear-speculum Ø 4 mm - blue	Blue			
31498	Disposable Mini ear-speculum Ø 2.5 mm - green	Green			
31499	Disposable Mini ear-speculum Ø 4 mm - green	Green			
31501	HEINE dispenser for Mini ear-speculum - empty		31485-8, 31491-2, 31495-9	-	-

GIMA code	CONNECTORS FOR MINI EAR SPECULUM	Colour	To be used with GIMA codes	
31493	Connector to GIMA Parker otoscope for Mini ear-speculum	Green	31435, 31436, 31437, 31440, 31441, 31442, 31471, 31473, 31475, 31477, 31480	
31494	ALLIGATOR connector (supplied with 100 ear speculum)	Green	31435, 31436, 31437, 31440, 31441, 31442, 31471, 31473, 31475, 31477, 31480	



## HEINE DISPOSABLE MINI EAR-SPECULUM



GIMA code	HEINE DISPOSABLE MINI EAR SPECULUM*	Minimum order
31501	HEINE dispenser for mini speculum - empty	-
31502	HEINE disposable Allspec® speculum Ø 2.5 mm - grey	dispenser of 250
31503	HEINE disposable Allspec® speculum Ø 4 mm - grey	dispenser of 250
31515	HEINE disposable Allspec® speculum Ø 2.5 mm - grey	box of 1,000
31516	HEINE disposable Allspec® speculum Ø 4 mm - grey	box of 1,000

\*Compatible with Heine Mini 2000/3000, K180, Beta 200

## RIESTER MINI EAR-SPECULUM



GIMA code	AUTOCLAVABLE MINI EAR SPECULUM for all Riester otoscopes	Colour	Minimum order
31817	Riester ear speculum Ø 2.5 mm - black	Black	box of 10 pcs.
31819	Riester ear speculum Ø 4 mm - black	Black	box of 10 pcs.
DISPOSABLE MINI EAR SPECULUM			
Only for E-Scope otoscopes			
31566	E-Scope ear speculum Ø 2.5 mm - black	Black	box of 100 pcs.
31567	E-Scope ear speculum Ø 4 mm - black	Black	box of 100 pcs.
Only for Ri-Scope L1, L2 Pen- scope, Ri-mini			
31827	Ri-Scope ear speculum Ø 2.5 mm - black	Black	box of 100 pcs.
31828	Ri-Scope ear speculum Ø 4 mm - black	Black	box of 100 pcs.

## REUSABLE CANNULAS AND EAR SPECULUM

GIMA code	AUTOCLAVABLE SPECULUM FOR PARKER OTOSCOPES - LATEX FREE	Colour	To be used with GIMA code	Also compatible with	Minimum order
31447	Kit 3 autoclavable veterinary speculum Ø 4, 5, 7 mm	Black	31442		One kit
31448	Kit 3 autoclavable speculum Ø 2.5, 3.5, 4.5 mm	Black	31435-37, 31440-42, 31471, 31473, 31475, 31477, 31480	Heine®, Kawe, Riester	One kit
31451	Kit of 5 autoclavable speculum Ø 2.5, 3.5, 4.5, 5.5, 9 mm	Black	31435-37, 31440-42, 31471, 31473, 31475, 31477, 31480	Heine®, Kawe, Riester	One kit
31453	Kit of 3 metal veterinary cannulas (Ø 4, 5, 6 mm) + 2 slotted metal specula (Ø 7.5 and 9.4 mm)	Grey	31422, 31424, 31425		One kit
31483	Pneumatic bulb for Otoscopes	Grey	31435/36/37/40/42/71/73/75/77-31520/21/22, 31535	Heine, Kawe, Riester	-

Gima autoclavable ear speculum 31447, 31448, 31451 features:  
 - made from resilient thermoplastic material  
 - smooth matte finish surface ensure easy cleaning  
 - Metallic bayonet lock for positive fit to otoscope  
 - autoclavable at 134°C



2 slotted models with 60 mm opening and round edges, ideal for instrumentation, atraumatic insertion

31453 5.0 mm 6.0 mm 9.4 mm 7.5 mm 4.0 mm

Matte inner surface to reduce risk of reflection. For use with Vet open otoscope heads. See page 443

## OTOSCILLO® ELECTRICAL IRRIGATOR

### • 25800 PROFESSIONAL OTOSCILLO®

Otosillo® is designed for automated ear rinsing both in hospitals and during private consultations. Innovative, compact, efficient and rapid, it combines the most sophisticated operating qualities with the best security guarantees, all in a single device. Otosillo® is an electrical irrigation for simplified rinsing of the ear canal. The pulsating stream system makes it easier to remove cerumen, even at low pressure control, Otosillo® is particularly suitable for treatment of sensitive ear canals. It looks less alarming and it is easier to use, with greater accuracy and security, than the alternatives. The water basin is removable to allow easy filling and emptying. Supplied with automatic back stop behind disposable nozzle for preventing cross-infections.

Operating power: 220 V - 50/60 Hz.

### • 25817 SPARE HANDLE + TUBE

### • 25814 DISPOSABLE TIPS SET

(100 disposable tips, 1 disk, connector) for 25800 and 25815 (old Otosillo®)

### • 25818 DISPOSABLE TIPS for 25800

and 25815\* - box of 100

\*Needs 25814

MADE IN GERMANY



Manual in GB, FR, DE, IT, ES.



Otosillo is supplied with 100 disposable tips, 1 disk, connector, carrying handle and temperature test card

## GLASS-METAL AND ALL-METAL EAR SYRINGES



MADE IN GERMANY

### GLASS-METAL JANET RECORD SYRINGES

High quality, reliable and accurate glass-metal syringes. Janet Record come complete with 2 cannulas, one conical, one oval. Individually packed in cardboard box.

GIMA code	GLASS-METAL SYRINGES COMPLETE WITH 2 CANNULAS
25801	Janet Record 50 cc - 13 x Ø 3.5 cm
25802	Janet Record 100 cc - 14 x Ø 4.7 cm
25803	Janet Record 200 cc
25804	Spare cannula for Janet Record (conical shape)
25805	Spare cannula for Janet Record (olive shape)
25861	Ear irrigation tip - single use - box of 40

### ALL-METAL SCHIMMELBUSCH SYRINGES

High quality, reliable and accurate syringes. Schimmelbusch come complete with 3 cannulas and ear bowl. Individually packed in cardboard box.

GIMA code	ALL-METAL SYRINGES COMPLETE WITH 3 CANNULAS AND EAR BOWL
25806	Schimmelbusch 50 cc
25807	Schimmelbusch 100 cc
25808	Schimmelbusch 200 cc
25809	Spare cannula for Schimmelbusch (conical shape)
25812	Spare cannula for Schimmelbusch (olive shape) small
25813	Spare cannula for Schimmelbusch (olive shape) large
25861	Ear irrigation tip - single use - box of 40

## HIGH CAPACITY POLYPROPYLENE SYRINGES

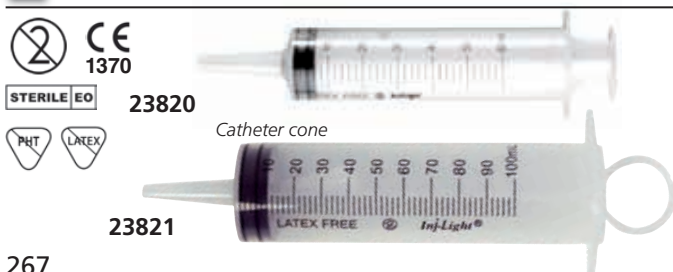

### HIGH CAPACITY POLYPROPYLENE SYRINGES - sterile

Sterile, single use, latex free syringes for ear and other purposes. Box in GB, FR, IT, ES, DE, PT, GR, RO, RU, YU, SA. Medical Device class IIa.

GIMA code	HIGH CAPACITY, POLYPROPYLENE SYRINGES STERILE - CATHETER CONE	Minimum order
23820	Syringe 60 ml	box of 20
23821	Syringe 100 ml	box of 25



# OTOCLEAR® EAR IRRIGATION SYSTEM

Kit includes:  
1 spray wash bottle  
20 otoclear tips  
1 ear basin



25858



- 25858 OTOCLEAR EAR SPRAY WASH  
- manual, intermittent lavage  
- delivers greater volume compared to syringes or other manual devices  
- efficient design allows for two handed procedure

- 25861 OTOCLEAR EAR IRRIGATION TIPS  
single use - box of 40 - spare  
Flared design protects against over-insertion. The tip directs three streams of water towards the walls of the ear canal, away from the tympanic membrane, creating a turbulent lavage that effectively dislodges the cerumen. The exit portal controls backsplash and directs drainage into a basin.
- 25862 EAR IRRIGATION BASINS - box of 3 - spare



Thermometer for water temperature



Improved patient comfort thanks to the soft "gentle touch" design

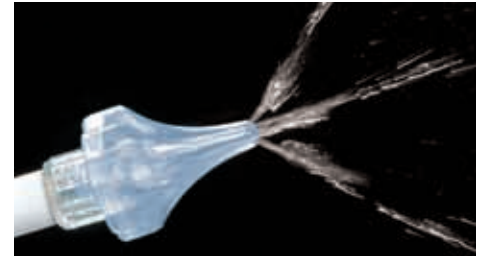

Patented 3-stream action

# LOOP-SPOON EAR CURETTES

- 31470 GIMA EAR CURETTES - box of 10 pcs  
Double function currettes: one side spoon, one side loop.  
Each currette is individually packed in a single pouch.

31470



Loop side

Spoon side

# BIONIX EAR CURETTES

**FLEXLOOP:**  
For normal curretage  
Most flexible of all  
Least traumatic  
Rounded tips for comfort  
4 mm wide tip

**MICROLOOP:**  
For compact cerumen  
More rigid construction  
Tip can be angled for added strength  
Rounded tip for comfort  
3 mm wide tip

**INFANTSCOOP:**  
For the smallest ears  
For when a small scoop works better  
Can be used through an otoscope • Flexible  
2 mm wide tip

**CERASPOON:**  
For viscous cerumen  
For extensive cerumen buildup  
For when a large scoop works better  
4 mm wide tip

The complete cerumen management system

- 31462 FLEXLOOP - white - box of 50 pcs
- 31464 INFANTSCOOP - light blue - box of 50 pcs
- 31460 MICROLOOP - green - box of 50 pcs
- 31467 CERASPOON - yellow - box of 50 pcs



Our four styles of currettes give you the most effective, economical and safe way to remove cerumen - whatever the size of ear or consistency of cerumen.

**Patient comfort:** Metal currettes are cold, hard and sharp. BIONIX ear currettes with rounded plastic tips reduce trauma and risk of laceration. Latex free.

**Effectiveness:** Ear currettes can duplicate the effectiveness of metal currettes in almost any situation and their polypropylene composition makes them virtually unbreakable.

**Disposability:** Ear currettes don't require expensive and time-consuming sterilization and eliminate the risk of cross-contamination.



# LIGHTED EAR CURETTES

- 31450 KIT MIXED LIGHTED CURETTES  
Kit is composed by 50 lighted currettes (8 FlexLoop and 7 of each of below other 6 tip styles) + LED illuminator + magnification lens



MicroLoop®  
3 mm diameter loop



FlexLoop®  
4 mm diameter tip



InfantScoop®  
2 mm diameter tip



AngleLoop®  
Angled 4 mm diameter loop



WaveCurette™  
new wave like 2.5 mm tip



VersaLoop®  
3 mm wide tip



CeraSpoon®  
4 mm wide tip



Scan QR code with your web enabled camera phone to see Video



31458

Lighted forceps for foreign body removal with LED illuminator

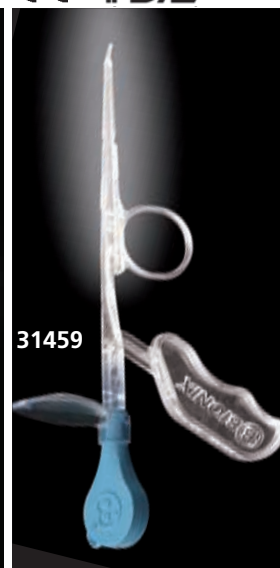

31459

Lighted ear currette 3 mm tip with LED illuminator

- 31461 KIT MICROLOOP
- 31463 KIT FLEXLOOP
- 31465 KIT INFANTSCOOP
- 31466 KIT ANGLELOOP
- 31468 KIT VERSALOOP

All kits are composed by 50 lighted currettes + LED light source + magnification lens

- 31458 LIGHTED FORCEPS - box of 10 + magnification lens + LED illuminator
- 31459 LIGHTED ARTICULATING CURETTES - box of 25 + magnification lens + LED light source

Ear currette tip has a 90° range of motion. It articulates to assist in removal of cerumen from the ear canal

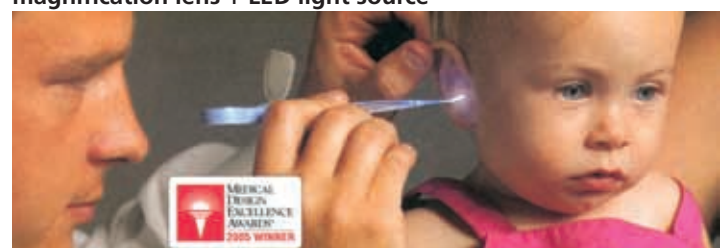

## WOOD TONGUE DEPRESSORS



**PERSONALIZATION**  
minimum: 100,000 pieces  
ask for leaflet



Quality tongue depressors manufactured with selected high quality smooth birch wood. Edges accurately finished. 150x18x1.6 mm. Individually packed in a paper envelope and sterilized.

Wooden medical tongue depressors made of quality birch wood. Edges accurately finished. Size: 150x18x1.6 mm

GIMA code	WOOD TONGUE DEPRESSOR - STERILE
25511	Tongue depressor - box of 50
25512	Tongue depressor - box of 2,000 (40 boxes of 50 pcs)

GIMA code	WOOD TONGUE DEPRESSORS NON-STERILE
25509	Tongue depressor - box of 100
25510	Tongue depressor - box of 5,000 (50 boxes of 100 pcs)

## PLASTIC TONGUE DEPRESSORS



Multilingual box: GB, FR, IT, ES, DE, PT, GR, Arab

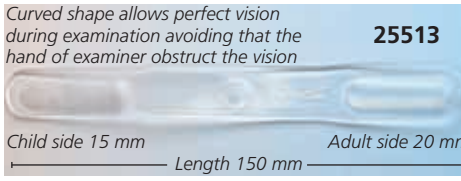

**PLASTIC TONGUE DEPRESSOR**  
Translucent tongue depressors made of polystyrene with curved shape and smooth edges. One end in adult size and one end in child size. Latex and PVC free. Sterile model is individually packed in a peel-open pack (ethylene oxide).

GIMA code	PLASTIC TONGUE DEPRESSORS ADULT/PEDIATRIC NON-STERILE	CE
25513	Tongue depressor - box of 100	CE 0120
25515	Tongue depressor - box of 90	CE 0120
25516	Tongue depressor - box of 1,800 (20 boxes of 90 pcs)	CE 0120

### 25505 PLASTIC COLOURED TONGUE DEPRESSORS

Plastic tongue depressor animal shaped with bright colour. Each tongue depressor is individually packed in transparent pouch. Packed in box of 50 pieces.



## STERILE ENT KITS

**31456 STERILE ENT KIT A - box of 25 kit**  
Kit includes one plastic nasal speculum, one plastic tongue depressor and two (adult and pediatric size) plastic ear funnels in single sealed pouch.

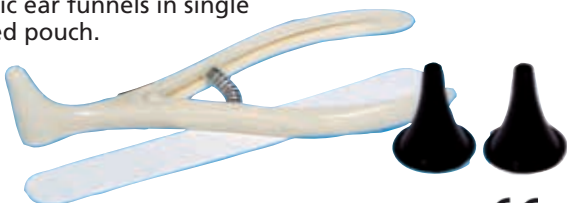

**31457 STERILE ENT KIT B - box of 10 kit**  
Kit includes one plastic nasal speculum, one plastic tongue depressor, two (adult and pediatric size) plastic ear funnels, two plastic laryngeal mirrors, one plastic forceps, six cotton tip applicators, one napkin, all packed in a sterile plastic tray (22x12.5x3 cm).



## NASAL SPECULUM



Total blade depth: 33 mm  
Total length: 13.2 cm

The use of stainless steel speculum can be a chilling experience for the patient. Now you can combine patient comfort with effective treatment. Smooth, warm tips make disposable Nasal Speculum more comfortable and less alarming to the patient.  
**31469 DISPOSABLE NASAL SPECULUM - box of 88**  
Innovative plastic, disposable nasal speculum with handle: allows superior view of nasal cavity. Helps extract foreign objects from nasal cavity. Facilitates packaging of cauterizing of bleeding noses. Latex free.

## THROAT SCOPE®

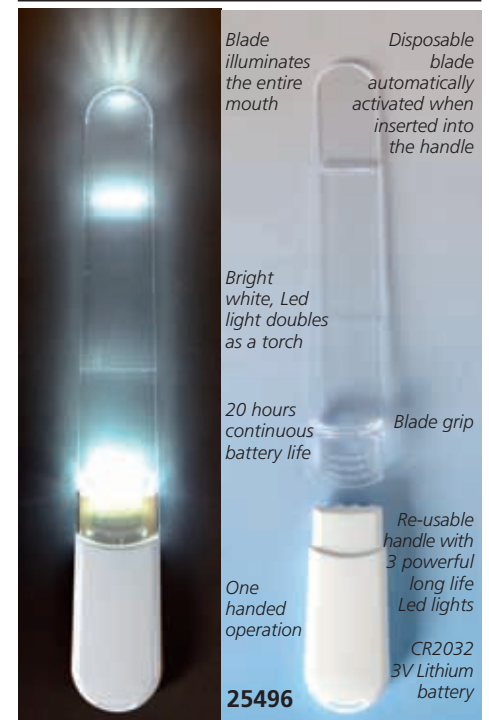

Blade illuminates the entire mouth  
Disposable blade automatically activated when inserted into the handle  
Bright white, Led light doubles as a torch  
20 hours continuous battery life  
Blade grip  
Re-usable handle with 3 powerful long life Led lights  
One handed operation  
CR2032 3V Lithium battery

**25496 THROAT SCOPE® KIT**  
1 handle + 50 blades - box  
Illuminated tongue depressor, made of medical grade plastic, that allows the clinician a one handed operation for oral cavity examination. The light is guided by the blade to illuminate the mouth for a quick examination by the clinician. Light is automatically activated when you insert single use blade into the handle.  
**25499 THROAT SCOPE® DISPOSABLE BLADES - box of 100 - non sterile**  
**25500 THROAT SCOPE® DISPOSABLE BLADES - box of 50 - non sterile**

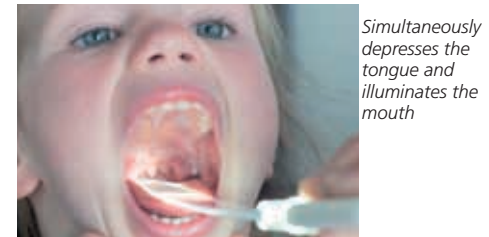

Simultaneously depresses the tongue and illuminates the mouth

## WELCH ALLYN PENLIGHT



- 25622 W.A. HALOGEN PENLIGHT with 2 x AAA batteries Professional bright white halogen light. Durable solid brass construction.
- 25618 BULB for W.A. PENLIGHT - spare



## HEINE MINI-C LED<sup>HQ</sup> LIGHT



- 25630 HEINE MINI-C EXAMINATION LIGHT LED<sup>HQ</sup> - D008.73.109 Compact, long-life pocket diagnostic light. 20,000 switch cycles guaranteed. Replaceable batteries size AAA (included).



## TOP QUALITY BULB OR LED PENLIGHTS

Professional penlights, also suitable for diagnostic, with bulb or white LED with quick clip shifter mechanism or push button (25634).

Argenta and Elegance made of anodized aluminium, Nova in top-quality ABS plastic housing. Supplied with 2x1.5V AAA batteries.

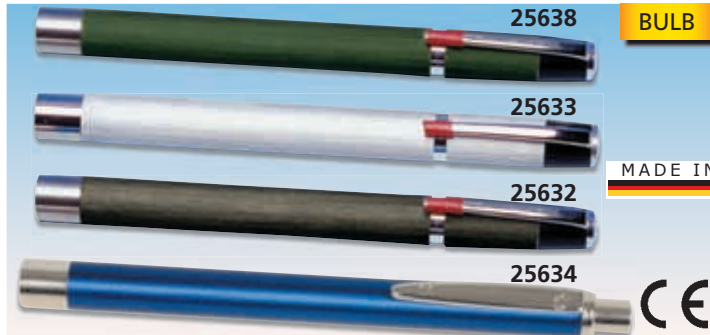

GIMA code	Description	Light	Light intensity	Material	Supplied with batteries	Colour	Medical device	on/off by
25632	Argenta torch	bulb	4.5 lux	metal	2 x AAA	black	Class I	Pocket clip
25633	Argenta torch	bulb	4.5 lux	metal	2 x AAA	silver	Class I	Pocket clip
25638	Argenta torch	bulb	4.5 lux	metal	2 x AAA	green	Class I	Pocket clip
25634	Elegance torch	bulb	4.5 lux	metal	2 x AAA	blue	Class I	Push button
25440	Nova torch	LED	25,000 m	plastic	2 x AAA	white	Class I	Pocket clip
25442	Argenta torch	LED	25,000 m	metal	2 x AAA	blue	Class I	Pocket clip

## BULB OR LED TORCHES PENLIGHTS

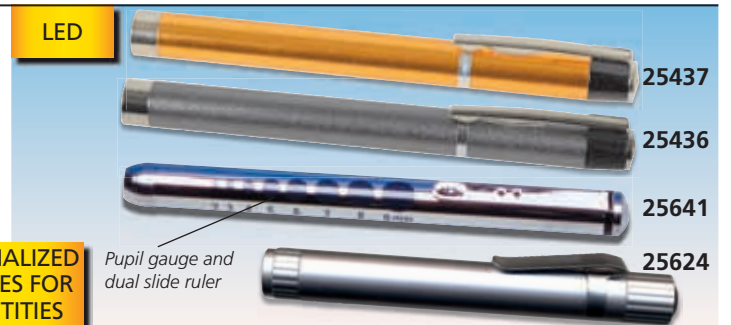
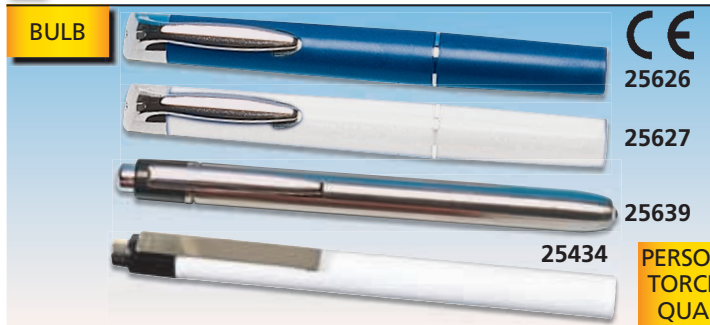

GIMA code	Description	Light	Material	Supplied with batteries	Colour	Packaging	Multilingual instructions	on/off by
25626	Alfa torch	bulb	plastic	2 x AAA	blue	Blister	GB, FR, IT, ES, PT DE	Pocket clip
25627	Alfa torch	bulb	plastic	2 x AAA	white	Blister	GB, FR, IT, ES, PT DE	Pocket clip
25639	Beta torch	bulb	stainless steel	2 x AAA	silver	Plastic case	GB, FR, IT, ES	Push button
25434	Stylo torch	bulb	metal	2 x AAA	white	Blister	GB, FR, IT, ES, PT DE	Push button
25641	Spirit torch	LED	chrome plated brass	2 x AAA	silver	Box	GB, FR, IT, ES	Pocket clip
25436	Omega Torch	LED	metal	2 x AAA	silver	Plastic case	GB, FR, IT, ES	Pocket clip
25437	Omega Torch	LED	metal	2 x AAA	gold	Plastic case	GB, FR, IT, ES	Pocket clip
25624	GIMA torch	LED	metal	1 x AAA	silver	Box	GB, FR, IT, ES	Push button

## DELTA PENLIGHTS WITH TONGUE DEPRESSOR HOLDER

- 25628 DELTA "LED" PENLIGHT - red
  - 25629 DELTA "LED" PENLIGHT - blue
- Delta penlights are supplied in aluminium box with 2 AAA batteries and holder for tongue depressors (tongue depressor not included). Box and instructions in: GB, FR, IT, ES, PT, DE.



25628



25629

- 25625 DELTA "LED" OTOSCOPE PENLIGHT - black
  - 31345 REUSABLE EAR SPECULUM 2.0 mm - bag of 25
  - 31346 REUSABLE EAR SPECULUM 4.0 mm - bag of 25
- Same as 25628-9 but with otoscope head, 3 ear funnels and 5 black plastic tongue depressors.



25625



25628



Box and instructions: GB, FR, IT, ES, PT, DE

## NEUROLOGICAL REFLEX PERCUSSORS - LATEX FREE



GIMA code	PERCUSSORS	Colour	Handle	Pin	Brush	Weight	Length
31270*	Buck Gima 2000	green	plastic/stainless steel	yes	yes	90 g	20 cm
31251*	Buck Classic	silver	chromed brass	yes	yes	90 g	18 cm
31252*	Buck colour-yellow	yellow	brass colour coated	yes	yes	105 g	19.5 cm
31271*	Dejerine Gima 2000	blue	plastic/stainless steel	yes	yes	115 g	21 cm
31254*	Dejerine Classic	silver	stainless steel	yes	yes	140 g	22 cm
31255*	Dejerine colour	red	stainless steel	yes	yes	140 g	22 cm
31256	Babinsky - Ø 4.5 cm	silver	chrome plated	yes	no	170 g	24 cm
31257	Queens - Ø 5 cm	silver	flexible plastic	no	no	100 g	33 cm
31258	Troemner	silver	stainless steel	no	no	200 g	23 cm
31260	Pinwheel	silver	chrome plated	no	no	50 g	18 cm
31272*	Babinsky-Gima 2000	green	plastic/stainless steel	no	yes	108 g	23.5 cm
31273*	Taylor Gima	red	plastic/stainless steel	no	yes	72 g	20 cm



\*Multilingual box: GB, FR, IT, ES, PT, DE, GR, Arabic

## THERMO FEEL

### • 31278 THERMO FEEL

Useful tool for diagnosis of neuropathy in diabetes patients. Both sides (one stainless steel and one plastic) are alternatively put in contact with foot skin of the patient. Patient perception of cool or warm allows a first diagnosis of diabetes.



## MONOFILAMENT - SENSORY EVALUATOR

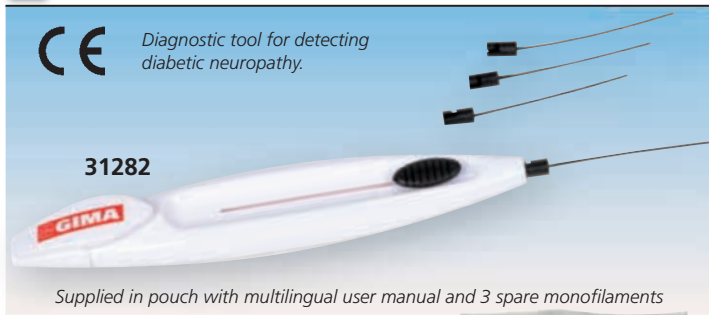

### • 31282 MONOFILAMENT TOOL - sensory evaluator

Plastic retractable monofilament with 3 spare monofilaments. Evaluates both diminishing and returning sensation (touch test). Examines levels of sensory function and changes in neuro status. Monofilament is calibrated at 10 g. Size: 13x2.5 cm + 4 cm monofilament

### • 31281 KIT OF 3 MONOFILAMENTS - spare



## NEUROLOGICAL KIT



### • 31265 NEUROLOGICAL KIT - 3 hammers

This kit includes 3 metal hammers in a foam box: Taylor hammer, Buck hammer and Babinsky hammer.

## TWO POINTS DISCRIMINATOR

### • 31279 TWO POINTS DISCRIMINATOR

Plastic (ABS) caliper with scale printed on aluminium plate. Two point discrimination is the ability to discern that two nearby objects touching the skin are truly two distinct points, not one.

It is often tested with two sharp points during a neurological examination and reflects how finely innervated an area of skin is. Reliable and widely used technique for determining tactile gnosis.

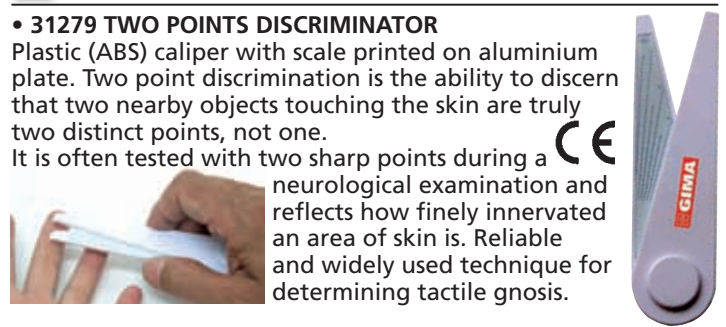



## GERMAN-MADE DIAPASONS - TUNING FORKS

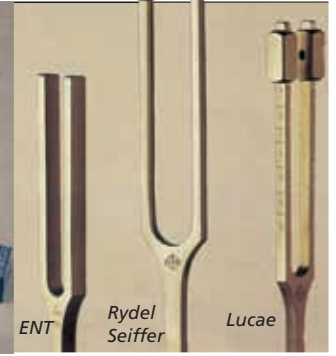

### ENT TUNING FORKS:

All made in Germany, with age-long craftsmanship experience, in special alloy that ensures maximum sound precision.

GIMA code	ENT TUNING FORKS
31230	Tuning fork 128 Hz* - with weight
31231	Tuning fork 256 Hz* - with weight
31232	Tuning fork 512 Hz
31233	Tuning fork 1024 Hz
31234	Tuning fork 2048 Hz
31235	Tuning fork 4096 Hz
31240	Set of 5 tuning forks in a stylish lined case (contains 128 Hz*, 256 Hz*, 512 Hz, 1024 Hz, 2048 Hz). <i>Tuning forks with asterisk * are supplied with weight</i>

### ENT/NEUROLOGY TUNING FORKS

All made of a special alloy and supplied with base. All tuning forks have multilingual manual and box: GB, FR, IT, ES, PT, GR. Additional DE, HU, RO, BG only for 31247.  
**MADE IN GERMANY**

GIMA code	ENT/NEUROLOGY TUNING FORKS
31245	Tuning fork a1-440 Hz - ENT - 90 g
31246	Tuning fork - LUCAE - 85 g adjustable from c128 to h240 with foot
31247	Tuning fork C64, c128 - RYDEL SEIFFERT detachable slider either C64 or c128 - 130 g

## ALUMINIUM ALLOY DIAPASONS - TUNING FORKS

- 31225 ALUMINIUM TUNING FORK 128 Hz
  - 31226 ALUMINIUM TUNING FORK 128 Hz - with foot
- Made of finest aluminium alloy and precisely shaped to meet highest requisites (standards) in medical field.

Resting pad for forehead



## NYSTAGMUS SPECTACLES - DR. FRENZEL

**MADE IN GERMANY**

- 31204 NYSTAGMUS SPECTACLES - DR. FRENZEL - black
- Easy to use in the search of spontaneous or provoked nystagmus. Fixed, biconvex lens + 18.0 diopters. Nystagmus spectacles should be connected only with < 4.2 V transformer as per safety norms 93/42/EEC. See code 31203 or 31214

- 31214 BATTERY handle for 31204



Offers mobility during examination. Needs 3x1.5 V CLR14 batteries (not included). Manual GB, IT, SE.

- 31203 PLUG-IN TRANSFORMER for 31204 - 100-240 V, 47-63 Hz

- 31206 BATTERY NYSTAGMUS SPECTACLES - DR. FRENZEL - black

This model allows wireless working and is provided with power through the adjustable battery placed above the spectacle. Requires three 1.5 Volt batteries, size C LR14/AM-2 (baby cells). Illumination can be adjusted through a turn of the switch.

- 31208 NYSTAGMUS BULB - spare for 31204, 31206

- 31207 LED BATTERY NYSTAGMUS SPECTACLES - white

Same as 31206 with LED and inner function that makes easier watching the rashes within a particular time period (30, 60, 90 seconds).

- 31209 LED POWER SUPPLY NYSTAGMUS SPECTACLES - white
- Same as 31204 with LED and rechargeable power supply.



CE  
Suggested for long examinations  
31204

Supplied with head strip

Multilingual manual:  
GB, FR, IT, ES, PT, GR



LED + BATTERY

Suggested for short examinations  
31207

Adjustable illumination through a slight turn around of the switch

Multilingual manual:  
GB, FR, IT, ES, PT, GR



LED + POWER SUPPLY

Supplied with head strip, rechargeable power supply  
31209

Adjustable illumination

Manual:  
GB, IT

## USB VIDEONYSTAGMOSCOPE SYSTEMS

- 31213 VIDEO-NYSTAGMOSCOPE - USB - mask with Ir camera and USB cable

Facilitate to view and register the Nystagmus through standard vestibular tests (both position and instrumental proof). This system allows to view on the monitor or PC/Notebook images of patient eyes during tests and to make Visual Suppression Test (VST) through a green LED light inside the mask to allow fixation. Innovative technology allows to get quality images. Power 12V DC.

**MADE IN ITALY**



752x582 pixels resolution  
520 TV lines

31213

## OPTOMETRIC CHARTS

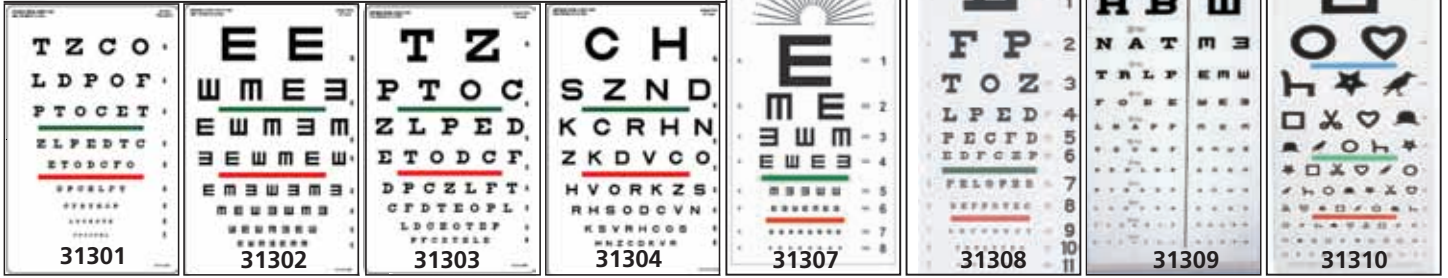

GIMA code	OPTOMETRIC CHARTS*	Working distance	Size cm
31301	SNELLEN eye chart with red/green bar visual acuity test	10 feet 3 m	23x35.5
31302	TUMBLING "E" colour vision chart-visual acuity screen	20 feet 6.1 m	23x35.5
31303	SNELLEN eye chart for visual acuity and colour vision test	20 feet 6.1 m	23x35.5
31304	SLOAN colour bar visual acuity chart	20 feet 6.1 m	23x35.5
31307	TUMBLING "E" eye chart	20 feet 6.1 m	28x56
31308	TRADITIONAL SNELLEN eye chart	20 feet 6.1 m	28x56
31309	MIXED DECIMAL chart**	10 feet 3 m	28x56
31310	EWING illiterate test chart	20 feet 6.1 m	28x56
31311	SLOAN near vision chart (2 sides printed)	16 inches 40 cm	18x23

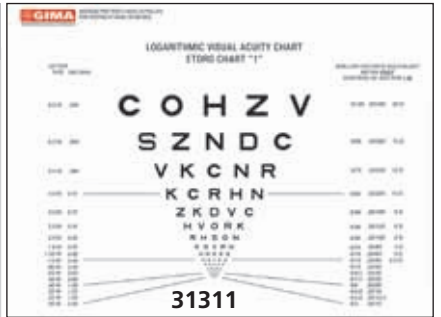

\*Polypropylene natural white sheet, approx. thickness 0.8 to 1.0 mm Multilingual instructions: GB, FR, IT, ES \*\*Not suitable for Portugal

## LEA SYMBOLS AND NUMBERS VISION CARDS AND CHARTS



### • 31322 LEA SYMBOLS NEAR VISION CARD - 40 cm (16 inches)

This test measures near visual acuity with proportionally spaced (logMAR) lines on the front and lines with 25% and 50% spacing on the back. Response key printed on test card. Includes training cards and instructions. Card measures 20.3x25.4 cm (8x10").

### • 31323 LEA SYMBOLS 15-LINE DISTANT CHART - 3 m (10 feet)

This test is designed for vision screening at schools and assessment of vision of children with special needs beginning with age of 3 years. Has a hole for hanging the chart on the wall. Includes semi-transparent response key and instructions. 43x53.4 cm (17x21"). Folds to 43x26.7 (17x10.5").

### • 31324 LEA NUMBERS NEAR VISION CARD - 40 cm (16 inches)

Designed to measure visual acuity with a standard line test and with three tighter spaced tests; 50%, 25%, and 12.5%, which often reveal difficulties in seeing tightly crowded details. Card measures 20.3x25.4 cm (8x10").

### • 31325 LEA NUMBERS 15-LINE DISTANT CHART - 3 m (10 feet)

This test is designed for vision screening at schools and assessment of vision of children with special needs beginning with age of 5 years. Has hole for hanging on the wall. 45.7x50.8 cm (18x20"). Folds to 45.7x25.4 (18x10").

## LOW CONTRAST CHARTS



• 31317 CONTRAST SENSITIVITY CARD - NEAR VISION 40 cm size 40x34 cm

• 31318 CONTRAST SENSITIVITY CHART - FROM A DISTANCE 3 m size 77x61 cm

It checks for the ability to distinguish light and dark (contrast). It can detect vision problems. Also useful to reveal in time regression or progression of the cataract disease.

## OCCLUDERS



• 31275 EYE OCCLUDER - 170x200x3 mm

• 31274 OCCLUDER - 154 x Ø 47 mm

• 31276 FUN FROSTED OCCLUDER GLASSES Set of two tiger fun frosted glasses to be used as occluder during children examinations one to occlude each eye.

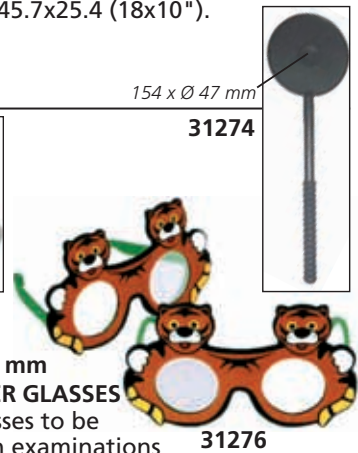

## OPTOMETRIC PENCILS

### • 31319 OPTOMETRIC PENCILS - set of 2 pcs

Set of two wooden puppets (red and white) used to capture attention during vision evaluation in young non-verbal children. Can also be used for test of convergence.

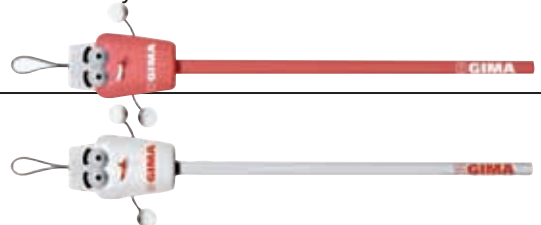

## LANG STEREOTEST®



- 31294 LANG STEREOTEST® I
  - 31295 LANG STEREOTEST® II
- LANG STEREOTEST® represents today's standard of random dot stereo tests without the need of 3D glasses, with very high sensitivity and specificity for stereopsis. The test combines random dots and a lenticular grid surface, and has been designed for quick screening of binocular vision in all groups of age, including very young children. While the test card is presented at reading distance, the patient is asked about what he sees and his eye movements are being observed. Recognition of figures is only possible if the person has full global stereopsis, while patients with amblyopia and (even small angle) strabismus fail the test. LANG STEREOTEST® I shows three stereo figures with disparities of 1200, 600 and 550 arcsec. LANG STEREOTEST® II has four stereo figures with disparities of 600, 400, 200 and 200 arcsec, of which one is also monocularly visible.
- 31296 LANG FIXATION STICK
  - 31297 LANG FIXATION CUBE - white
  - 31298 LANG FIXATION CUBE - red

MADE IN SWITZERLAND

Quick and easy stereopsis test, even for small children



## STEREOPTIC TEST

- 31293 STEREOPTIC TEST
- Test performed at a distance of 30-40 cm, allowing evaluation of eyes cooperation in providing one single image to the brain, starting from two separately showed figures. Suitable for children from one year old and for adults in case of suspected strabismus, amblyopia or visual reduction.

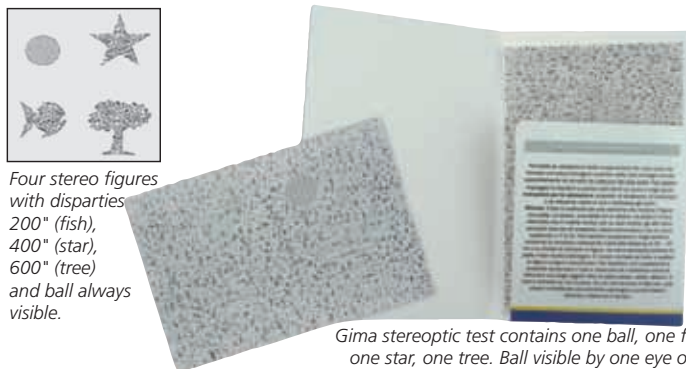

Four stereo figures with disparities 200" (fish), 400" (star), 600" (tree) and ball always visible.

Gima stereoptic test contains one ball, one fish, one star, one tree. Ball visible by one eye only.

## WORTH LED LIGHT TEST

- 31289 WORTH LED LIGHT TEST - with red/green glasses
  - 32201 "AA" ALKALINE BATTERIES - blister of 4 pcs
- The Worth 4 dot test, is a clinical test for suppression of either the right or left eye. Suppression occurs during binocular vision, when the brain does not process the information received from either of the eyes. This is a common adaptation to strabismus, amblyopia, and aniseikonia. Battery not included, glasses included.
- Multilingual instructions: GB, FR, IT, ES, PT, DE, GR, Arabic.



## ISHIHARA COLOUR TEST

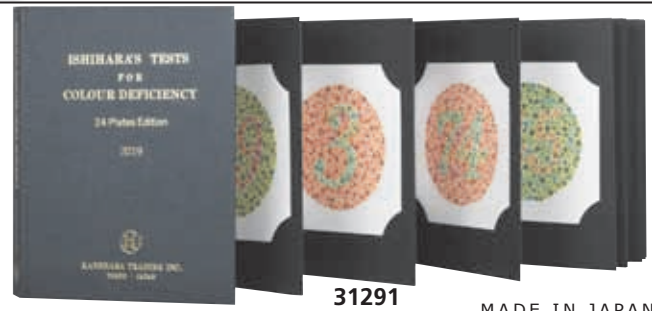

31291

MADE IN JAPAN

### ISHIHARA COLOUR TEST

Testing for colour deficiency requires high level of sensitivity and specificity. This series of plates is provided to detect colour blindness in people who can not read, and colour deficiency, since young age. Plates are designed with simple geometrical shapes, since the examinees may not be able to understand complicated pieces. Test gives quick and accurate assessment of colour vision deficiency of congenital origin.

Most cases are diagnosed with red-green deficiency which may be of two types:

- protan, which may be absolute (protanopia) or partial (protanomalina)
- deutan, which may be absolute (deutanopia) or partial (deutanomalina)

GIMA code ISHIHARA COLOUR TEST

- 31290 Book of 10 plates for illiterates
- 31291 Book of 24 plates
- 31292 Book of 38 plates

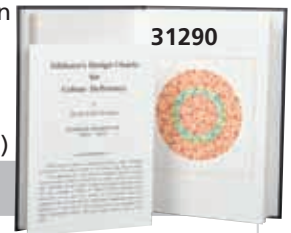

## GIMA COLOUR TEST

- 31288 GIMA ADULT COLOUR TEST - 15 plates
  - 31286 GIMA PEDIATRIC COLOUR TEST - 10 plates
- Single plates (11.5x11 cm) packed in a practical aluminium box (13.5x11.5x2.3 cm).

Multilingual box and instructions: GB, FR, IT, ES, PT, DE, PL, RO, LT, SK, Arabic



## SCHIÖTZ TONOMETER

- 31220 SCHIÖTZ TONOMETER - straight scale
- 31222 SCHIÖTZ TONOMETER - inclined scale

A masterpiece of precision mechanism, measures intraocular pressure according to Prof. Schiötz standards. Vital parts are made of stainless steel. High quality agate bearing for extremely long service life. Set 3 weights included (5.5-7.5-10 g). Scale specification 5. In black deluxe case with velvet-look inserts. Perfect reading of the scale with red pointer.

MADE IN GERMANY



31220 straight



31222 inclined

CE 0124

## MULTIUSE SOFT CASES

- 27137 MULTIUSE SOFT CASE - black
- 27138 MULTIUSE SOFT CASE - blue

Inner insert divides this bag into two compartments, one for stethoscope, one for nurse accessories. Bottom compartment with one elastic pocket and one transparent zipper pocket. Upper compartment with 6 elastic loops, one transparent zipper pocket and one mesh pocket. Double zip for easy access. Size: 28x12.5x6.5 cm. Supplied with carrying handle.



## CLASSIC CASE FOR STETHOSCOPES

- 32667 CLASSIC CASE FOR STETHOSCOPES - black
- 32668 CLASSIC CASE FOR STETHOSCOPES - burgundy
- 32669 CLASSIC CASE FOR STETHOSCOPES - turquoise

High quality protective hard case for classic style, single tube stethoscopes, available in 3 colours. Its design holds the stethoscope secured in place by a preformed interior, keeping the sensitive diaphragm and tubing protected. Lightweight EVA construction and strong protective outer shell covered in 1680D nylon. Pre-formed moulded interior can also be removed for flexible usage. Sealed dustproof and waterproof zipper with rubber easy-grip zipper pulls for easy opening and closing. Interior mesh pocket for additional accessory storage. Carry handle for easy transportation. Outside size 28x16x5 cm; inside size 26.5x14.5x4 cm. Weight: 220 g



## COVERS FOR STETHO

Covers for stetho for pediatric applications, fits every kind of stethoscopes.

GIMA code	COVERS FOR STETHOSCOPES
32653	Pig cover for stethoscopes
32654	Dragon cover for stethoscopes

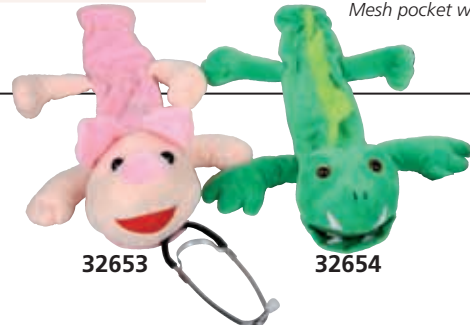

## SPARE PARTS AND ACCESSORIES FOR STETHOSCOPES

GIMA code	QUALITY "Y" TUBING	Minimum order
32620	"Y" tubing mixed colours	box of 20
32621	"Y" tubing - black	box of 20
32622	"Y" tubing - green	box of 20
32623	"Y" tubing - blue	box of 20
32624	"Y" tubing - red	box of 20
32625	"Y" tubing - orange	box of 20
32626	"Y" tubing - light blue	box of 20
32627	"Y" tubing - yellow	box of 20
32628	"Y" tubing - purple	box of 20
32629	"Y" tubing - pink	box of 20
BINAURAL - DIAPHRAGM - HEADS		
32655	One head chest piece - black ring	10 pcs.
32656	Dual head chest piece - black ring	10 pcs.
32666	BERTA binaural - fixed	1
32678	Diaphragm Ø 45mm for Classic adult	10 pcs.
EARTIPS AND ADAPTORS		
32657	Standard eartips - rigid - universal	box of 10
32658	Rigid eartips screw-type - for Classic, Wan, Yton, Duca, Regalite	box of 10
32663	Mushroom eartips for Trad, Wan, Yton, Design, Linus, Regalite and classic stethoscopes	box of 10





## TRAD STETHOSCOPES - GOOD VALUE FOR MONEY

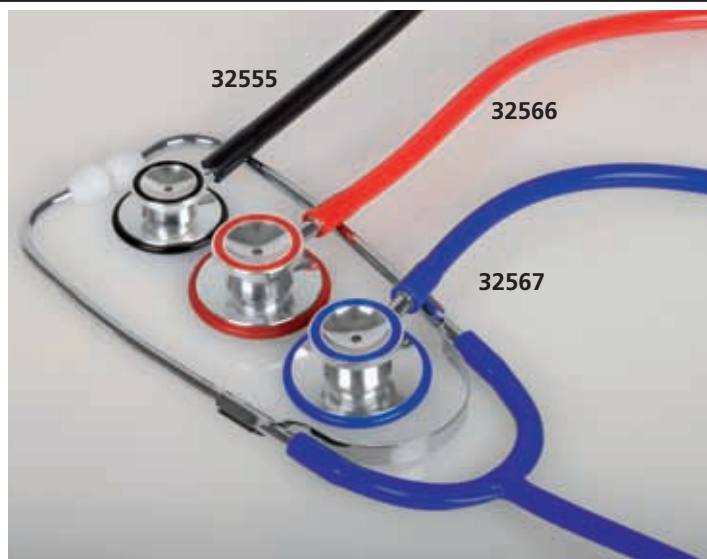

**TRAD STETHOSCOPES: adult, pediatric**  
 Traditional aluminium stethoscopes, lightweight and reliable.  
 Chestpiece diaphragm Ø 43.5 mm (Ø 35 for pediatric model), bell Ø 30 mm (Ø 26.5 for pediatric model) external sizes.  
 Brass binaural, non chill ring.  
 Tubing: length 62 cm, int. Ø 4 mm, ext. Ø 8 mm.  
 Supplied in cardboard box. Manual and box in 11 languages: GB, FR, IT, ES, DE, PT, GR, PL, HU, SE, Arabic.



GIMA code	TRAD STETHOSCOPES - LATEX FREE	
32557	TRAD single head - pediatric - pink	
32559	TRAD single head - pediatric - light blue	
32555	TRAD double head - pediatric - black	
32560	TRAD single head - black	
32561	TRAD single head - red	
32562	TRAD single head - blue	
32563	TRAD single head - yellow	
32564	TRAD single head - purple	
32558	TRAD single head - dark green	
32565	TRAD double head - black	
32566	TRAD double head - red	
32567	TRAD double head - blue	
32568	TRAD double head - dark green	
32678	Diaphragm Ø 44 mm - spare	

## COLOURED TRAD STETHOSCOPES

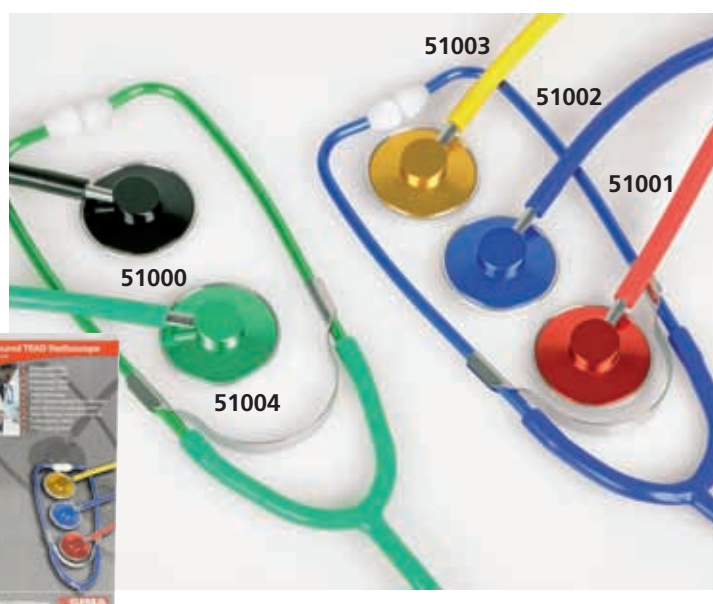

**COLOURED TRAD STETHOSCOPES**  
 Coloured aluminium stethoscopes, lightweight and reliable.  
 Chestpiece diaphragm Ø 43.5 mm, bell Ø 30 mm external sizes.  
 Brass binaural.  
 Tubing: length 62 cm, int. Ø 4 mm, ext. Ø 8 mm.  
 Supplied in cardboard box.  
 Manual and box in 11 languages: GB, FR, IT, ES, DE, PT, GR, PL, HU, SE, Arabic.

GIMA code	COLOURED TRAD STETHOSCOPES - LATEX FREE	
51000	TRAD single head - black	
51001	TRAD single head - red	
51002	TRAD single head - blue	
51003	TRAD single head - yellow	
51004	TRAD single head - green	
51010	TRAD double head - black	
51011	TRAD double head - red	
51012	TRAD double head - blue	

## WAN STETHOSCOPES - ADULT



### WAN ADULT STETHOSCOPES

Features a chrome-plated zinc-alloy chestpiece, a screw-on plastic retaining ring, outer spring binaural and colour matched moulded PVC tubing with non-chill ring. Assure optimum acoustic performances.

Chestpiece: Ø 45 mm, bell Ø 30 mm.  
Tubing: length 63 cm, int. Ø 4.2 mm, ext. Ø 8 mm.

Supplied in a cardboard box.  
Manual and box in 11 languages: GB, FR, IT, ES, DE, PT, GR, PL, HU, SE, Arabic.

GIMA code	WAN STETHOSCOPES - LATEX FREE	
32569	WAN single head adult - black	■
32570	WAN single head adult - royal blue	■
32571	WAN single head adult - burgundy	■
32572	WAN single head adult - orange	■
32574	WAN double head adult - black	■
32575	WAN double head adult - royal blue	■
32576	WAN double head adult - burgundy	■
32577	WAN double head adult - orange	■
32678	Diaphragm Ø 44 mm - spare	

## PEDIATRIC-NEONATAL STETHOSCOPES



### WAN PEDIATRIC AND NEONATAL STETHOSCOPES:

Features a chrome-plated zinc-alloy chestpiece, a screw-on plastic retaining ring, outer spring binaural and colour matched moulded PVC tubing with non-chill ring. Assure optimum acoustic performances.

Chestpiece: Ø 35 mm, bell Ø 30 mm, (pediatric) or Ø 22 mm, bell Ø 19 mm (neonatal). Tubing length: 63 cm.

Supplied in a cardboard box. Manual and box in 11 languages: GB, FR, IT, ES, DE, PT, GR, PL, HU, SE, Arabic.

### WAN PLUS:

Same as standard with inner spring binaural, superior tubing quality and 2 pair of soft colour coordinated ear tips in different size.

GIMA code	WAN STETHOSCOPES - LATEX FREE	
32508	WAN double head neonatal - red	■
32509	WAN double head neonatal - grey	■
32513	WAN double head pediatric - light-blue	■
32515	WAN double head pediatric - red	■
32511	WAN PLUS double head pediatric - pink	■
32506	WAN PLUS double head pediatric - black	■

## YTON STETHOSCOPES

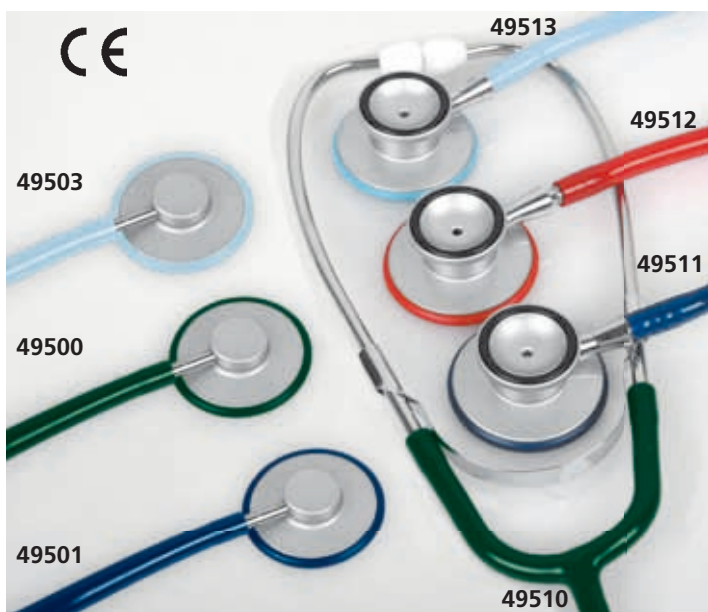

### YTON STETHOSCOPES:

Gima Yton stethoscopes with single or double head.

Solid aluminium chestpiece Ø 45 mm, bell Ø 30 mm (for double head), with colour coordinated plastic retaining ring. "Duracote" finished.

Available in four different colours: dark green, dark blue, red and aqua blue.

Manual and box in 11 languages: GB, FR, IT, DE, ES, PT, GR, PL, SE, HU, Arabic.



GIMA code	YTON STETHOSCOPES - LATEX FREE	
49500	Yton single head - dark green	■
49501	Yton single head - dark blue	■
49502	Yton single head - red	■
49503	Yton single head - aqua blue	■
49510	Yton double head - dark green	■
49511	Yton double head - dark blue	■
49512	Yton double head - red	■
49513	Yton double head - aqua blue	■

## JOTARAP STETHOSCOPE: DOUBLE-HEAD, DOUBLE TUBE



Gima Sprague Rappaport type double-head, double-tube, latex free stethoscope at the price of a standard stethoscope. **5 in 1, five way convertible type stethoscope**  
This convertible stetho, zinc alloy treaded with chrome plated chestpiece drum fitting with different sized chestpieces bells, provides versatile acoustics for infants and adults for the detection of a wide range of heart and lung sounds.

GIMA code	JOTARAP STETHOSCOPE	
32579	JOTARAP - purple	
32580	JOTARAP - black	
32581	JOTARAP - blue	
32582	JOTARAP - neon orange	
32583	JOTARAP - green	
32584	JOTARAP - neon yellow	
32585	JOTARAP - light blue	
32586	JOTARAP - fuchsia	
32587	JOTARAP - transparent pink	
32590	ACCESSORY KIT - spare	

Improved valve mechanism. This mechanism normally eliminates acoustic leakage

Chestpiece with small and large diaphragm. **Double tubing for individual sound transmission**

Two separate 56 cm (22") thick latex free wall tubing provide individual sound transmission from chestpiece to both sides of the ear. **Complete in cardboard box with accessory kit (32590)**

It is supplied with an accessory pouch containing:

3 interchangeable plastic black non-chill bells, adult and pediatric spare diaphragm, one pair clear neoprene eartips, one pair black mushroom eartips. Multilingual manual (GB, FR, DE, IT, ES, PT, GR, PL, HU, SE, RO, NL, LV, SK, Arabic).

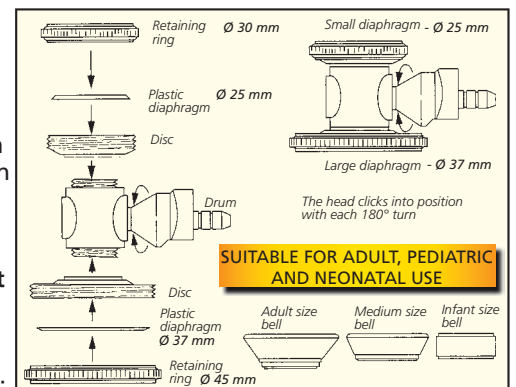

## LINUX STETHOSCOPES



Chestpiece Ø: 44 mm  
Tubing: length 62 cm  
int. Ø 4 mm  
ext. Ø 8 mm

- 32518 LINUX STETHOSCOPE - blue
- 32524 LINUX STETHOSCOPE - black
- 32529 LINUX STETHOSCOPE - red

Single head stethoscope with lightweight zinc alloy chestpiece plated with an attractive satin finish. The special design assures better performances by pushing the back of the head.

Non-chill diaphragm retaining rim for patient comfort. Stainless steel binaurals fixed at 15° angle for greater comfort and acoustic seal. Soft and flexible PVC tubing. Supplied in deluxe box with one pair of plastic eartips and PVC eartips. Manual and box in 11 languages: GB, FR, IT, ES, DE, PT, GR, PL, HU, SE, Arabic.

# ACOUSTIC EXCELLENCE DOUBLE HEAD STETHOSCOPES



**CLASSIC STAINLESS STEEL STETHOSCOPES - Adult and Pediatric**  
 High quality stethoscope with **stainless steel chestpiece**, stainless steel double inner spring binaural and durable, elegantly moulded PVC tubing for unsurpassed acoustic performance. The colour coordinated flexible 55 cm (22") PVC "Y" tubing, non-chill ring and diaphragm retaining ring provide excellent patient comfort, while adding attractiveness. It comes in a foam lined box with 2 extra sets of soft eartips. Chestpiece: Ø 45 mm (adult), Ø 35 mm (pediatric). Manual and box in: GB, FR, DE, IT, ES, PT, GR, PL, HU, SE, RO, BG, Arabic.

GIMA code	CLASSIC DOUBLE HEAD S/S STETHOSCOPES - ADULT
32531	Classic adult - dark green
32532	Classic adult - orange
32533	Classic adult - light blue
32534	Classic adult - black
32535	Classic adult - burgundy
32536	Classic adult - dark blue
32537	Classic adult - green
32538	Classic adult - red
32539	Classic adult - pink
32540	Classic adult - royal blue
32541	Classic adult - lilac

**CLASSIC IN 11 COLOURS**

Black	Dark blue	Royal blue	Light blue	Green	Dark green	Burgundy	Orange	Red	Pink	Lilac
-------	-----------	------------	------------	-------	------------	----------	--------	-----	------	-------

GIMA code	ACCESSORIES - SPARES
32678	Diaphragm Ø 44 mm - spare for Classic adult
32664	Rigid eartips screw-type - white spare for Classic/Wan/Yton/Duca/Regalite

GIMA code	CLASSIC DOUBLE HEAD S/S TEACHING STETHOSCOPES
32542	Classic Teaching - black <i>allows simultaneously auscultation by 2 people</i>

GIMA code	CLASSIC DOUBLE HEAD S/S STETHOSCOPES - PEDIATRIC
32512	Classic pediatric - light-blue
32516	Classic pediatric - black

## CARDIOLOGY STETHOSCOPES

- 32550 CARDIOLOGY CLASSIC STETHOSCOPE - blue
  - 32551 CARDIOLOGY CLASSIC STETHOSCOPE - burgundy
  - 32552 CARDIOLOGY CLASSIC STETHOSCOPE - black
- Cardiology Classic offers acoustical excellence in a traditional design with superior durability. Its innovative features include:
- stainless steel chestpiece (Ø 33-44 mm) with extra deep cone-shaped bell for a superb low frequency response
  - stainless steel double inner spring binaural
  - ultra-sensitive diaphragm for unsurpassed amplification
  - durable, elegantly moulded 55.5 cm (22") PVC tubing (int. Ø 6.5 mm, ext. Ø 12 mm)
- Manual and box in 11 languages: GB, FR, DE, IT, ES, PT, GR, PL, HU, SE, Arabic.

• 32678 DIAPHRAGM Ø 44 mm - spare

*Colour coordinated non-chill ring and diaphragm retaining ring, PVC tubing*



32552

It comes in a foam lined box with 2 extra set of PVC eartips  
279

32552

## PROFESSIONAL STETHOSCOPE

- 32526 REGALITE - black
- Top quality single head stethoscope. Chromed plated chestpiece with "SUPERFLEX" inner spring binaural and 1 piece moulded, PVC tubing. Supplied in deluxe box, with spare soft eartips and one space diaphragm. Manual and box in 7 languages: GB, FR, IT, ES, PT, GR, Arabic.



32526



## GIMA EVOLVE DUAL HEAD STETHOSCOPES



### GIMA EVOLVE DUAL HEAD STETHOSCOPES

High acoustics and sensitivity stethoscope line with 4 different heads and attractive selection of coloured tubing. Chestpiece combination with floating diaphragms which allow to hear low and high frequency sounds applying light or firm pressure on chestpiece. Stainless steel chestpiece can catch lower frequency sound sensitively. Its inner side is polished making it smooth and reducing sound's attenuation during sound detection. Attractive selection of fashion coloured and trendy tubes. New electrical plating technology for longer life and corrosion resistance.

#### Features

- dual head chestpiece (Ø 48 mm and 36 mm) with anti-chill rings
- ergonomic and soft silicone eartips for best comfort



- aluminium binaural with spring inserted into the tube (stainless steel for Rose Gold version)
- PVC tube Ø 10 mm, length 60 cm
- total length 75 cm

Supplied with nametag and spare kit in transparent case including 2 pairs of soft eartips and 2 floating diaphragms. Multilingual box and manual: GB, FR, IT, ES, PT, DE, NL, PL, CZ, BG, RO, HR, GR, SE, Arabic.

GIMA code	GIMA EVOLVE DUAL STETHOSCOPES - length 75 cm		
	SHINY HEAD SERIES	Binaural	Ring
49550	Gima Evolve - black	mirrored	black
49551	Gima Evolve - navy blue	mirrored	transparent
49552	Gima Evolve - burgundy	mirrored	black
49553	Gima Evolve - turquoise	mirrored	transparent
49554	Gima Evolve - grey	mirrored	transparent
49555	Gima Evolve - dark green	mirrored	transparent
49556	Gima Evolve - red	mirrored	transparent
SHINY HEAD SERIES - glitter tubing			
49563	Gima Evolve - ceil blue	mirrored	transparent
49564	Gima Evolve - teal green	mirrored	transparent
ALL BLACK HEAD SERIES			
49567	Gima Evolve - black	black	black
49568	Gima Evolve - caribbean blue	black	black
49569	Gima Evolve - emerald green	black	black
49570	Gima Evolve - chocolate	black	black
MULTICOLOUR HEAD SERIES			
49574	Gima Evolve - raspberry	mirrored	transparent
49575	Gima Evolve - black	black	black
ROSE GOLD HEAD SERIES			
49578	Gima Evolve - white	rose gold	transparent
SPARE KITS			
			Colour
49580	Kit: 2 floating diaphragms with rims, 2 pairs of eartips		black
49581	Kit: 2 floating diaphragms with rims, 2 pairs of eartips		transparent

## MEDIKALL CLEAN PROOF S HYGIENIC COVER FOR STETHOSCOPES

### • 32595 MEDIKALL CLEAN PROOF S - box of 500

Medikall clean Proof S is proven to be an effective disposable barrier for stethoscopes against germs. It doesn't decrease the quality of auscultation.

Easy to use, efficient through significant time saving and first of all: safe for protecting patients and physicians.

Multilingual box: GB, FR, IT, DE, ES, PT



#### PROTECTION GUARANTEED

By the effective and safe germ barrier

**ERKA.**  
THE ORIGINAL  
Made in Germany since 1889

**TIME SAVING**  
Significant time saving compared to conventional disinfection with exposure time



MADE IN GERMANY

#### QUALITY IMPROVEMENT

No loss in the quality of auscultation



**SAFETY**  
It avoids risk of cross contamination

## RIESTER RI-SONIC PCP-USB AND PCP-1 ELECTRONIC STETHOSCOPES

- 51320 RI-SONIC PCP-1 ELECTRONIC STETHO - 3.5 mm stereo plug
- 51321 RI-SONIC PCP-USB ELECTRONIC STETHO- USB plug

The Riester Ri-sonic are electronic stethoscopes designed to provide auscultatory sound via Telemedicine, computer or through mobile device platforms. This can be done in real time remotely or through sharing of recorded files.

- the PCP-USB or PCP-1 stethoscope plugs directly into any mobile platform, PC or tablet computer via eMurmur App
- patented piezo technology for picking up body sounds with minimal background artefacts
- patients can use the stethoscope on themselves
- easy to use with a guidance of a clinicians.

Ri-sonic Electronic Stethoscopes enable a clinician to listen to internal body sounds, such as heart, lung or bowel sounds, of a patient.

### TECHNICAL SPECIFICATIONS

Mode of operation:	continuous operation
Electrical protection:	Class II protection against electrical shock
Plug:	USB plug (51321), 3.5 mm stereo plug (51320)
Voltage:	Input: 2 V - 5 V DC
Classification:	Type BF applied part
Weight:	180 g (51321), 145 g (51320)
MDD Class:	Class IIa

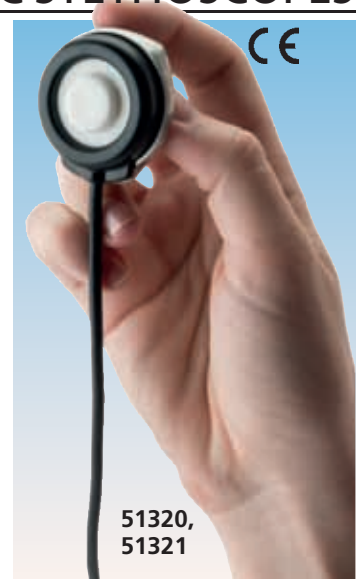

## RIESTER DUPLEX® 2.0 STETHOSCOPES, SIMPLY BETTER HEARING



### RIESTER DUPLEX® 2.0 STAINLESS STEEL STETHOSCOPES

Duplex® 2.0 stethoscopes are distinguished by outstanding acoustic performance.

They have been completely new constructed to meet the challenges of daily diagnostic practice. Special design tube for better auscultation of adults, children/babies or new-borns.

- precision double chest-piece made of stainless steel with innovative membrane support
- anatomically shaped binaural with internal multiple spring for adjusting the contact pressure
- extra-soft, replaceable and pivotable ear-tips for perfect sealing at the ear canal and enhanced wear comfort
- innovative acoustic system with extraordinary auscultation for all frequency ranges

- special membrane for precise acoustics with novel non-chill rims for improved adaptation on the skin
- Supplied with name plate, replacement ear-tips and membrane.

GIMA code	Riester code	RIESTER DUPLEX® 2.0 - STAINLESS STEEL - LATEX FREE				
		DUPLEX® 2.0 ADULT	Membrane	Length	Weight	
32333	4210-01	Duplex® 2.0 - black	Ø 44 mm	74 cm	151 g	
32334	4210-02	Duplex® 2.0 - white	Ø 44 mm	74 cm	151 g	
32335	4210-03	Duplex® 2.0 - blue	Ø 44 mm	74 cm	151 g	
32336	4210-04	Duplex® 2.0 - red	Ø 44 mm	74 cm	151 g	
		DUPLEX® 2.0 PEDIATRIC				
32338	4220-02	Duplex® 2.0 - white	Ø 32/23.5 mm	69 cm	124 g	
		DUPLEX® 2.0 NEW-BORN				
32340	4230-02	Duplex® 2.0 - white	Ø 24/17.5 mm	69 cm	105 g	

## RIESTER DUPLEX® STETHOSCOPES - ALUMINIUM CHEST-PIECE



### RIESTER DUPLEX® ALUMINIUM STETHOSCOPES

Riester DUPLEX® stethoscopes combine first-class quality at an attractive price. They offer outstanding acoustic performance for the daily challenges in office practices and hospitals.

Double-headed chest-piece in lightweight aluminium, galvanized. Special membrane for perfect auscultation with particularly flat and soft non-chill rims for improved adaptation on the skin. Bell Ø 36 mm.

Supplied with a pair of replacement ear-tips and a replacement membrane.

GIMA code	Riester code	RIESTER DUPLEX® - ALUMINIUM CHESTPIECE			
		DUPLEX® ADULT	Membrane	Length	Weight
51300	4001-01	Duplex® - black	Ø 48 mm	77 cm	151 g
51301	4001-02	Duplex® - slate grey	Ø 48 mm	77 cm	151 g
51302	4031-03	Duplex® - blue	Ø 48 mm	77 cm	151 g
51303	4033-05	Duplex® - green	Ø 48 mm	77 cm	151 g

## ERKA FINESSE STHETOSCOPES

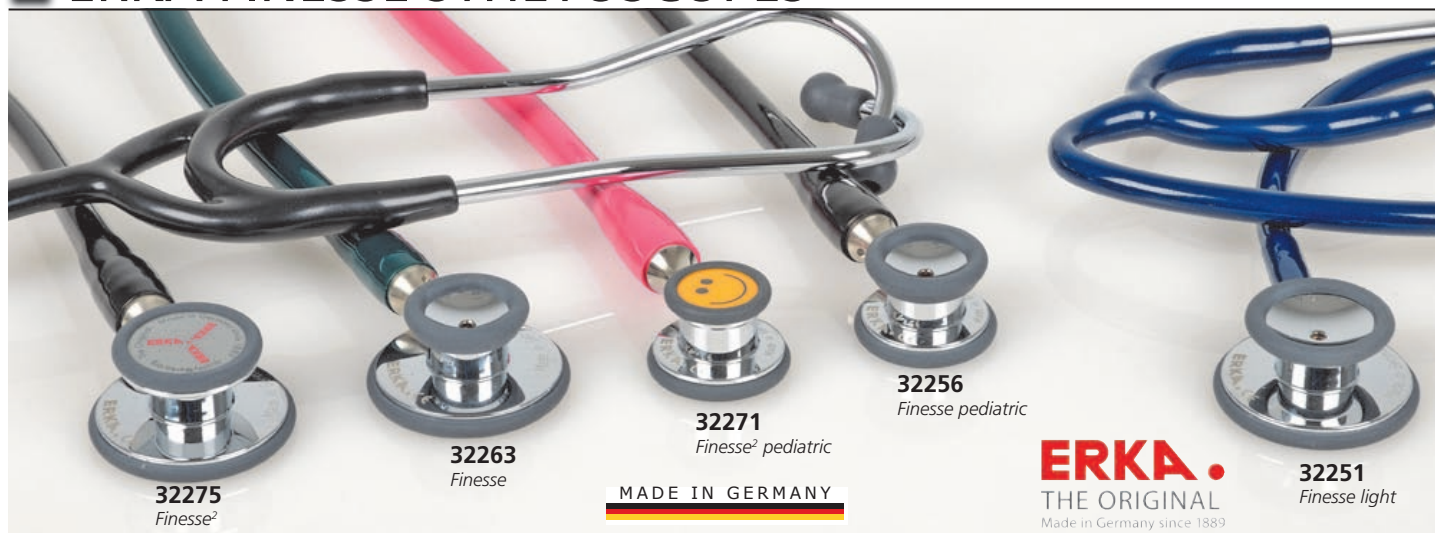

### FINESSE STHETOSCOPES

With the reversible double chest-piece you'll be prepared for all eventualities in everyday medical practice. The membrane side guarantees optimal auscultation for the entire frequency spectrum and the open bell side is specifically designed for low frequencies.

### FINESSE<sup>2</sup> STHETOSCOPES

The reversible, combined chest-piece has two membrane sides, each making the full frequency range perfectly audible. The large membrane is suitable for auscultation of adults and the small one for children or slim patients.

All Erka stethoscopes are supplied with carrying bag



FEATURES	Finesse Light	Finesse Finesse <sup>2</sup>
Pre-tensioned ERKA. convex membrane provides excellent resonance and sound.	X	X
Non-chill ring ensures highest patient comfort.		X
Superior polish, chromium-plated, non-porous surface and brass chest-piece ensure perfect surface hygiene.	X	X
Two internal channels run parallel in the stethoscope tubing preventing any noise caused by friction of two separate tubes.		X
Through the separately integrated spring in the tube, there is no acoustic loss from the chest-piece to the ear.		X
Ergonomic design and super soft tips provide excellent acoustic seal against external noise interference and maximize user's comfort.	X	X
Standard 15° inclined binaurals can be individually adapted to the specific ear canal of the user.	X	X

GIMA code	ERKA code	ERKA STHETOSCOPES - tubing length - 55 cm
<b>FINESSE LIGHT ADULT - head Ø 44.5/33.5 mm</b>		
32250	520 000 10	■ Finesse light - black
32251	520 000 20	■ Finesse light - navy blue
32252	520 000 55	■ Finesse light - dark green
<b>FINESSE PEDIATRIC - head Ø 31/26.5 mm</b>		
32256	549 000 00	■ Finesse pediatric - black
32257	549 000 25	■ Finesse pediatric - light blue
32258	549 000 35	■ Finesse pediatric - pink
<b>FINESSE ADULT - head Ø 44.5/33.5 mm</b>		
32262	550 000 00	■ Finesse adult - black
32263	550 000 05	■ Finesse adult - dark grey
32264	550 000 20	■ Finesse adult - navy blue
32265	550 000 55	■ Finesse adult - dark green
32266	550 000 60	■ Finesse adult - burgundy
<b>FINESSE<sup>2</sup> PEDIATRIC - head Ø 30/21.3 mm</b>		
32270	536 000 00	■ Finesse <sup>2</sup> pediatric - black
32271	536 000 35	■ Finesse <sup>2</sup> pediatric - pink
<b>FINESSE<sup>2</sup> ADULT - head Ø 47/30 mm</b>		
32275	535 000 00	■ Finesse <sup>2</sup> adult - black
32276	535 000 05	■ Finesse <sup>2</sup> adult - dark grey
32277	535 000 20	■ Finesse <sup>2</sup> adult - navy blue

## ERKAPHON STHETOSCOPES



Stethoscope with double chest piece is switchable from membrane to bell function. The membrane side is suitable for the auscultation of high and low frequency sounds while the bell side is designed for cardiac impulses.

### ERKAPHON STHETOSCOPES:

High quality precision stethoscopes for excellent acoustics. All stethoscopes are equipped with 56 cm long Y tube, brass chrome-plated binaural and chest-piece (32350, 32358) or aluminium (32344-7), membrane Ø 44 mm, bell Ø 30 mm (32358 only).

GIMA code	ERKA code	ERKAPHON STHETOSCOPES
<b>ERKAPHON FLAT CHESTPIECE - aluminium</b>		
32344	544 000 10	Erkaphon flat chestpiece - black
32345	544 000 20	Erkaphon flat chestpiece - navy blue
32346	544 000 25	Erkaphon flat chestpiece - light blue
32347	544 000 30	Erkaphon flat chestpiece - red
<b>ERKAPHON FLAT CHESTPIECE - chromed</b>		
32350	543 000 10	Erkaphon flat chestpiece - black
<b>ERKAPHON DOUBLE CHESTPIECE - chromed</b>		
32358	541 000 10	Erkaphon double chestpiece - black

# 3M™ LITTMANN® STETHOSCOPE USER GUIDE

CHOOSE THE RIGHT STETHOSCOPE TO HELP YOU PERFORM AT YOUR BEST

3M™ Littmann® Stethoscopes feature adjustable headsets with soft-sealing eartips. Mechanical stethoscopes are designed with tunable technology to hear different frequency sounds by simply adjusting the pressure applied to the chestpiece.

Acoustic performance, high quality and comfort you need with a Littmann stethoscope.



Authorized Distributor



## ACOUSTIC PERFORMANCE LEVELS AND FEATURES

	6	7-8	7-8	9-10	9-10	10+
	<b>Lightweight II S.E.</b>	<b>Classic II Paediatric and Infant</b>	<b>Master Classic II™</b>	<b>Classic III™ Monitoring</b>	<b>Cardiology IV™ Diagnostic</b>	<b>Master Cardiology™</b>
	Ideal for taking blood pressure readings and making limited patient assessments.	Hard-working, dependable, clinical tools for physical assessment and monitoring of your patients, one long shift after another.		Provide outstanding acoustic sensitivity to help you perform detailed diagnostic auscultation. Useful in challenging and critical care environments.		High-performance auscultation. Hear more with amplification, noise cancellation and mobile connectivity.
Length	71 cm	71 cm	69 cm	69 cm	69 cm	69 cm
Weight	118 g	105 g, 95 g	160 g	150 g	177 g	185 g
Warranty	2 years	3 years	3 years	5 years	7 years	7 years
Diaphragm	Tunable	Non-Tunable (Floating)	Tunable	Tunable (2)	Tunable (2)	Tunable
Approximate Chestpiece Ø	Double-sided: 5.2x4.5 cm 3.5x3.2 cm	Double-sided Paed.: 3.4 - 2.7 cm Infant: 2.8 - 1.7 cm	Single-sided: 4.3 cm	Double-sided Adult side: 4.3 cm Paediatric side: 3.4 cm	Double-sided Adult side: 4.3 cm Paediatric side: 3.4 cm	Single-sided: 4.8 cm
Features	Teardrop-shaped chestpiece Fits under blood pressure cuff	Specially designed for the smallest patients	Designed for easier grip and maneuvering	Convertible open bell	Convertible open bell Dual-lumen tubing	Dual-lumen tubing Best acoustic response in Littmann mechanical line

\*At peak frequency, vs. analogue mode

## ORDERING INFORMATION AND TUBE COLOUR GUIDE

FINISH: CHESTPIECE/EARTUBE/STEM	Lightweight II S.E.	Classic II Infant	Classic II Paediatric	Master Classic II™	Classic III™ Monitoring	Cardiology IV™ Diagnostic	Master Cardiology™	CORE Digital
Standard Finish	2450 Black	2114 Black	2113 Black	2144L Black	5620 Black	5627 Burgundy	6152 Black	6156 Plum
	2451 Burgundy	2114R Red	2113R Red	2146 Burgundy	5621 Grey	5633 Pearl Pink	6154 Navy	6158 Raspberry
	2452 Caribbean	2124 Caribbean	2119 Caribbean	2147 Navy	5622 Navy	5831 Plum	6155 Hunter Green	6184 Burgundy
	2454 Ceil Blue		2122 Raspberry		5623 Caribbean	5832 Lavender		2167 Plum
	2456 Pearl Pink				5630 Ceil Blue	5835 Turquoise		
All Black				2141 Black	5803 Black	5868 Burgundy	6163 Black	6168 Navy
Brass Finish								2161 Black
Copper Finish					5809 Chocolate			2175 Black
Smoke					5811 Black			2176 Black
Rainbow/Brass/Brass		2157 Raspberry	2153 Caribbean		5806 Raspberry	5807 Caribbean		
Rainbow/Black/Black					5870 Black		6165 Black	
Mirror/Smoke/Smoke					5959 Ceil Blue	5863 Navy		
Mirror/Standard/Mirror							6177 Black	6170 Burgundy
Champagne/Smoke/Smoke					5861 Black	5864 Burgundy		6179 Black
Champagne/Black/Champagne							6176 Burgundy	6190 Caribbean
High-Polish Rainbow/Black/Black							6242 Navy	
High-Polish Rainbow/Smoke/Smoke							6240 Black	6241 Raspberry

### COLOURED STEM SERIES (square inset represents stem colour)

Black/Black/Colour						6200 Black	6203 Black
High-Polish Smoke/Black/Colour						6201 Black	
High-Polish Smoke/Smoke/Colour						6202 Navy	6204 Black
Rainbow/Black/Colour						6232 Black	6234 Carb.
Champagne/Champagne/Colour						6238 Grey	
Smoke/Smoke/Colour					5872 Turq.	5875 Lime	
Mirror/Smoke/Colour					5873 Grey		
					5960 Plum	5962 Pink	

### COMPONENTS: CHESTPIECE/EARTUBE/STEM

Standard Finish	All Black	Brass Finish	High-Polish Rainbow	Mirror
Copper Finish	Smoke	Champagne	High-Polish Smoke	Rainbow



## 3M™ SINGLE-PATIENT STETHOSCOPES

3M™ has developed a new stethoscope, which combines advanced acoustic engineering and infection prevention. It is intended for single-patient use, adult or child in an isolation area, and to be disposed when no longer needed. It helps to reduce potential risks of patient-to-patient cross-contamination, that could occur using reusable stethoscope.

- high-quality acoustics with clear and reliable sound
- soft and flexible earplugs isolate from noises
- pressure sensitive diaphragm allows to hear high and low frequency sounds, by varying pressure on the chestpiece.
- comfortable flexible headset and angled ear tubes provide an excellent seal
- flexible tubing, to easily move and position chestpiece
- easy-grip moulded chestpiece for multiple hand positions.

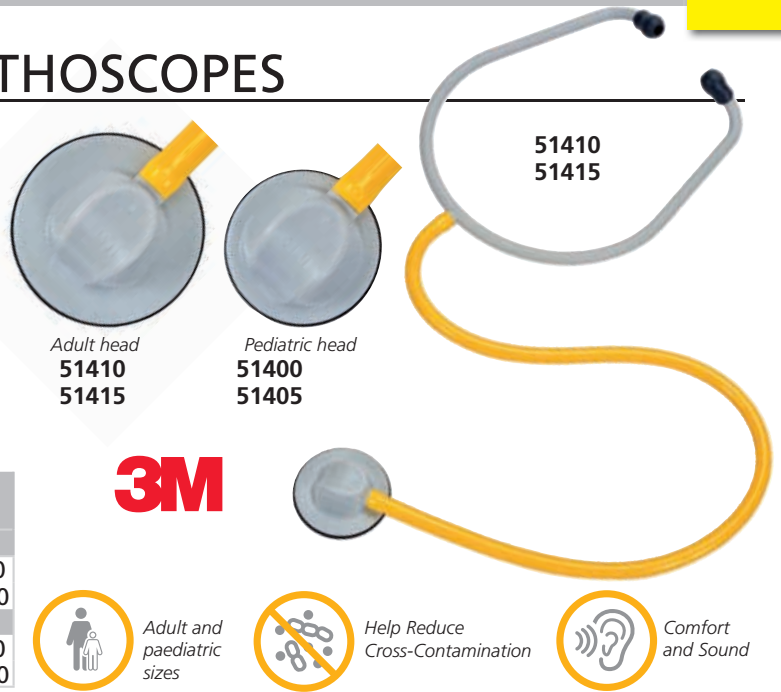

GIMA code	3M code	3M™ SINGLE-PATIENT STETHOSCOPES - length 72.4 cm	Minimum order
<b>Paediatric - head Ø 36.2 mm</b>			
51400	SPS-YP1010	3M™ Single-Patient - paediatric	box of 10
51405	SPS-YP1100	3M™ Single-Patient - paediatric	box of 100
<b>Adult - head Ø 45.2 mm</b>			
51410	SPS-YA1010	3M™ Single-Patient - adult	box of 10
51415	SPS-YA1100	3M™ Single-Patient - adult	box of 100

## 3M™ LITTMANN® LIGHTWEIGHT II

Tunable diaphragm for easy low and high frequency monitoring. Lightweight only 118 g. Headset made of aerospace alloy.

GIMA code	3M code	3M™ LITTMANN® LIGHTWEIGHT II S.E. - length 71 cm
32388	2456	■ Littmann® Lightweight II S.E. - pink
32389	2452	■ Littmann® Lightweight II S.E. - caribbean blue
32390	2450	■ Littmann® Lightweight II S.E. - black
32391	2451	■ Littmann® Lightweight II S.E. - burgundy
32392	2454	■ Littmann® Lightweight II S.E. - ceil blue
32393	2453	■ Littmann® Lightweight II S.E. - lilac



## 3M™ LITTMANN® ACCESSORIES

GIMA code	3M code	3M™ LITTMANN® ACCESSORIES
<b>TUNABLE DIAPHRAGM AND RIM + NON CHILL BELL SLEEVES + EARTIPS</b>		
51464	40005	■ For Classic II S.E. - black - blister
51465	40006	■ For Classic II S.E. - grey - blister
51466	40020	■ For Lightweight - black - blister
51467	40021	■ For Lightweight - light brown - blister
<b>TUNABLE DIAPHRAGM + RIM ASSEMBLY + EARTIPS</b>		
51470	40011	■ For Master Cardiology - black - blister
51471	40018	■ For Master Cardiology - grey - blister
51473	40022	■ For Master Classic™ - black - blister
51474	40023	■ For Master Classic™ - grey - blister
<b>TUNABLE DIAPHRAGM + 2 RIMS ASSEMBLY</b>		
51477	40012	■ For Classic II™ - Paediatric - black - blister
51478	40013	■ For Classic II™ - Infant - black - blister
<b>2 TUNABLE DIAPHRAGMS + RIM ASSEMBLY + EARTIPS</b>		
51482	40016	■ For Classic III™, Cardiology IV™, Core - black - blister
51483	40017	■ For Classic III™, Cardiology IV™, Core - grey - blister
<b>EAR TIPS for all models</b>		
51490	40001	■ Ear Tips - black - small and large - blister
51491	40002	■ Ear Tips - grey - small and large - blister
51494	40007	■ Name tag - black - blister
51495	40008	■ Name tag - grey - blister
<b>DIAPHRAGM + RETAINING RING - box of 5 pcs</b>		
32449	36572	■ For Cardiology III (small side) - black
32452	36554	■ For Master Cardiology - black
<b>DIAPHRAGM OR RETAINING RINGS</b>		
51445	MEMB/E3200	■ Diaphragm for Electronic 3100 - 3200 - black
32478	78808303222	■ Diaphragm for Electronic 3000 - dark grey
<b>NEOPRENE RINGS</b>		
32476	36547	■ Neoprene black ring - infant - box of 5
32455	36569	■ Neoprene grey ring - infant - box of 5
51455	36546	■ Neoprene black ring - pediatric - box of 5
32459	36544	■ Neoprene black ring - Classic II, Lightweight - box of 10



All accessories (from 51464 to 51495) are sold in blister

## 3M™ LITTMANN® CLASSIC III STETHOSCOPES

The 3M™ Littmann® Classic III™ Stethoscope offers high acoustic sensitivity for exceptional performance when doing general physical assessments.

- versatile adult and pediatric two-sides chestpiece
- dual single-piece tunable diaphragms (pressure sensitive)

- small-side diaphragm prevents debris in open bell
- high acoustic sensitivity
- snap tight soft-sealing eartips
- next generation longer-life tubing
- small side converts to open bell



Authorized Distributor

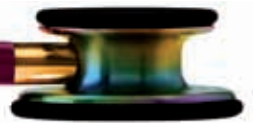

CLASSIC III - RASPBERRY - RAINBOW FINISH



GIMA code	3M code	3M™ LITTMANN® CLASSIC III MIRROR/CHAMPAGNE
32239	5960	Littmann® Classic III - plum - mirror
32240	5962	Littmann® Classic III - pearl pink - mirror
32243	5861	Littmann® Classic III - black - champagne
32245	5863	Littmann® Classic III - navy blue - mirror
32246	5864	Littmann® Classic III - burgundy - champagne
32249	5959	Littmann® Classic III - ceil blue - mirror

GIMA code	3M code	3M™ LITTMANN® STETHOSCOPES - length 69 cm
CLASSIC III - head Ø 43/33 mm		
32290	5620	Littmann® Classic III - black
32291	5622	Littmann® Classic III - navy blue
32292	5648	Littmann® Classic III - raspberry
32293	5627	Littmann® Classic III - burgundy
32295	5832	Littmann® Classic III - lavender
32296	5835	Littmann® Classic III - turquoise
32297	5839	Littmann® Classic III - lemon - lime
32299	5621	Littmann® Classic III - grey
32300	5623	Littmann® Classic III - caribbean blue
32303	5630	Littmann® Classic III - ceil blue
32304	5633	Littmann® Classic III - pearl pink
32306	5831	Littmann® Classic III - plum
CLASSIC III SPECIAL EDITION - head Ø 43/33 mm		
32307	5872	Littmann® Classic III - turquoise - smoke chestpiece
32308	5870	Littmann® Classic III - black - rainbow finish
32310	5803	Littmann® Classic III - black edition
32311	5809	Littmann® Classic III - chocolate - copper fin.
32312	5806	Littmann® Classic III - raspberry - rainbow fin.
32313	5807	Littmann® Classic III - caribbean blue - rainbow fin.
32314	5811	Littmann® Classic III - black - smoke finish
32317	5868	Littmann® Classic III - burgundy - black finish
32319	5873	Littmann® Classic III - grey - smoke chestpiece
32320	5875	Littmann® Classic III - lime-green - smoke chestpiece



## 3M™ LITTMANN® CLASSIC II STETHOSCOPES



GIMA code	3M code	3M™ LITTMANN® STETHOSCOPES - length 71 cm
CLASSIC II PEDIATRIC - head Ø 33/25 mm		
32404	2113	Littmann® Classic II ped. - black
32405	2119	Littmann® Classic II ped. - caribbean blue
32406	2113R	Littmann® Classic II ped. - red
32407	2122	Littmann® Classic II ped. - raspberry
32381	2153	Littmann® Classic II ped. - caribbean blue - rainbow finish
CLASSIC II INFANT - head Ø 27/19 mm		
32376	2124	Littmann® Classic II infant - caribbean blue
32410	2114	Littmann® Classic II infant - black
32411	2114R	Littmann® Classic II infant - red
32380	2157	Littmann® Classic II infant - raspberry - rainbow finish

CLASSIC II INFANT



CLASSIC II PEDIATRIC



## 3M™ LITTMANN® MASTER CLASSIC II



MASTER CLASSIC II



MASTER CLASSIC II BLACK EDITION

GIMA code	3M code	3M™ LITTMANN® MASTER CLASSIC STETHOSCOPES length 69 cm - head Ø 44 mm
32425	2146	Littmann® Master Classic II - burgundy
32426	2144L	Littmann® Master Classic II - black
32471	2141	Littmann® Master Classic II - "black edition"

## 3M™ LITTMANN® CARDIOLOGY IV STETHOSCOPES

The 3M™ Cardiology IV helps to catch more of the subtle critical sounds, thanks to the improved acoustics and the new design.

- better audibility of high-frequency sounds
- tunable diaphragms for hearing both high and low frequency sounds without turning over the chestpiece (pressure sensitive)
- adult and paediatric sides for more versatility
- single-piece smooth diaphragm, easier to attach and clean
- longer-life tubing and snap tight soft-sealing eartips.



 **Authorized Distributor**



GIMA code	3M code	3M™ LITTMANN® STETHOSCOPES - length 69 cm		
<b>CARDIOLOGY IV - head Ø 43/33 mm</b>				
32606	6152	■	Littmann® Cardiology IV - black	
32607	6184	■	Littmann® Cardiology IV - burgundy	
32608	6154	■	Littmann® Cardiology IV - navy blue	
32609	6155	■	Littmann® Cardiology IV - hunter green	
32610	6156	■	Littmann® Cardiology IV - plum	
32612	6158	■	Littmann® Cardiology IV - raspberry	
<b>CARDIOLOGY IV SPECIAL HIGH POLISH FINISH - head Ø 43/33 mm</b>				
			Tubing	Finish
32614	6232	■	Littmann® Cardiology IV black	smoke
32615	6234	■	Littmann® Cardiology IV Caribbean blue	smoke
32616	6238	■	Littmann® Cardiology IV grey	smoke
32617	6240	■	Littmann® Cardiology IV black	rainbow
32618	6241	■	Littmann® Cardiology IV raspberry	rainbow
32619	6242	■	Littmann® Cardiology IV navy blue	rainbow
32642	6204	■	Littmann® Cardiology IV black	smoke
32651	6202	■	Littmann® Cardiology IV navy blue	smoke
<b>CARDIOLOGY IV SPECIAL FINISH - head Ø 43/33 mm</b>				
32643	6190	■	Littmann® Cardiology IV Caribbean blue	champagne
32644	6176	■	Littmann® Cardiology IV burgundy	champagne
32647	6170	■	Littmann® Cardiology IV burgundy	mirror
32648	6177	■	Littmann® Cardiology IV black	mirror
32649	6179	■	Littmann® Cardiology IV black/champagne	smoke
32674	6239	■	Littmann® Cardiology IV plum	rainbow*

GIMA code	3M code	3M™ LITTMANN® STETHOSCOPES - length 69 cm		
<b>CARDIOLOGY IV SPECIAL FINISH - head Ø 43/33 mm</b>				
			Tubing	Finish
32630	6205	■	Littmann® Cardiology IV plum	rainbow
32632	6163	■	Littmann® Cardiology IV black	black edition
32634	6165	■	Littmann® Cardiology IV black	rainbow
32635	6166	■	Littmann® Cardiology IV plum	smoke
32636	6168	■	Littmann® Cardiology IV navy blue	black
32639	6200	■	Littmann® Cardiology IV black	black - red stem
32640	6201	■	Littmann® Cardiology IV black	black - blue stem
32641	6203	■	Littmann® Cardiology IV black	black - violet stem

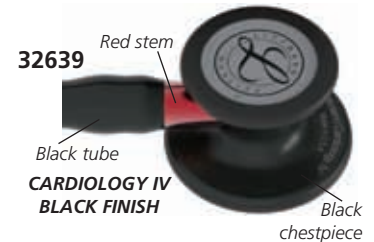
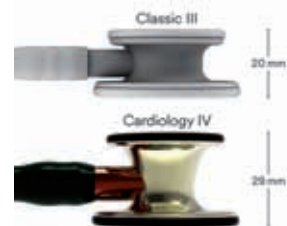

\*with violet stem

## 3M™ EKO CORE DIGITAL ATTACHMENT FOR CARDIOLOGY IV

• **32594 3M EKO CORE DIGITAL ATTACHMENT - 8481**  
Eko CORE allows to transform Littmann Cardiology IV from analog into digital stethoscopes. Single button press digitally amplifies heart, lung and other body sounds up to 40x (at peak frequency vs. analog) adding automated murmur detection (88% sensitivity and specificity), active noise cancellation and wireless listening. Compatible with most major brands and vet stethoscopes. See page 287 for more details



When ON, Eko CORE turns stethoscope into a smart detection tool, when OFF, stethoscope still works as an analog Cardiology IV. Supplied with rechargeable lithium battery (8 hour autonomy) and micro USB charging



## 3M™ LITTMANN® MASTER CARDIOLOGY STETHOSCOPES



 **Authorized Distributor**



**MASTER CARDIOLOGY BLACK EDITION**

GIMA code	3M code	3M™ LITTMANN® STETHOSCOPES - length 69 cm		
<b>MASTER CARDIOLOGY - head Ø 51 mm</b>				
32435	2160	■	Littmann® Master Cardiology - black	
32436	2163	■	Littmann® Master Cardiology - burgundy	
32437	2164	■	Littmann® Master Cardiology - navy blue	
32439	2167	■	Littmann® Master Cardiology - plum	
<b>MASTER CARDIOLOGY SPECIAL EDITION - head Ø 51 mm</b>				
32356	2175	■	Littmann® Master Card. - black - brass finish	
32360	2176	■	Littmann® Master Card. - black - smoke edition	
32473	2161	■	Littmann® Master Card. - black edition	

# 3M™ LITTMANN® CORE DIGITAL STETHOSCOPES

## 3M™ LITTMANN® CORE DIGITAL STETHOSCOPES

The new 3M™ Littmann® CORE digital stethoscope features outstanding acoustics, comfort and quality of a Littmann® Cardiology IV stethoscope, enhanced by powerful CORE digital attachment technology. It is intended for professional and clinical use on pediatric and adult patients.

### Eko software connection via Bluetooth

Software allows to capture (15, 30, 60 or 120 second recordings), visualize heart sound waveforms in real time, analyze and share recordings to monitor progression of a disease. Eko App is available for iOS and Android devices.

### Active noise cancellation

It reduces unwanted background sounds allowing to auscultate with greater confidence.

### Toggle between analog and amplified listening modes

Two tunable diaphragms (adult and pediatric) allow to listen both high and low frequency sounds by simply adjusting pressure on chestpiece.

### Up to 40x amplification

Based on comparison of analog versus electronically assisted amplified listening with maximum volume at peak frequency (125 Hz). Adjustable volume by clicking buttons on the CORE side.

- Tunable, dual-sided stainless steel chestpiece with open or closed bell



- rotating adult and pediatric chestpiece
  - soft-sealing ear tips conform to ears, providing an excellent acoustic seal and comfortable fit
  - fully charged battery lasts 8 hours in continuous transmission mode
  - 3 selectable filters: cardiac, pulmonary and wide
  - 7 sound amplification levels
  - heart murmur, tachycardia and bradycardia detection
- Supplied with USB cable, spare snap tight soft-sealing eartips, non-chill bell sleeve, multilingual user manual: GB, FR, IT, ES, PT, DE, NL, PL, HU, DK, SE, NO.

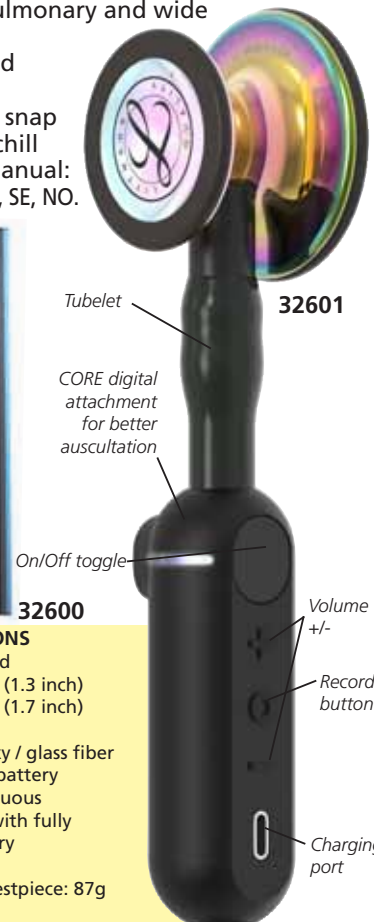

TECHNICAL SPECIFICATIONS	
Chestpiece:	two-sided head size: 3.3 cm (1.3 inch) 4.3 cm (1.7 inch)
Membrane:	floating material: epoxy / glass fiber
Battery:	rechargeable battery
Operating time:	8 hours continuous transmission with fully charged battery
Overall length:	69 cm
Weight:	net: 232g chestpiece: 87g
Automatic shutdown:	5 min.

GIMA code	3M code	3M™ LITTMANN® CORE DIGITAL STETHOSCOPE - length 69 cm		
		Tubing	Finish	
32600	8490	Littmann® Core Digital	black	black
32601	8572	Littmann® Core Digital	black	rainbow
32602	8863	Littmann® Core Digital	black	copper
32603	8869	Littmann® Core Digital	black	mirror
32594	8481	EKO Core digital attachment - spare*		

\*See page 286

# LINKTOP DIGITAL STETHOSCOPE - WITH BLUETOOTH 5.0

## • 32599 LINKTOP STETHOSCOPE - with Bluetooth 5.0

This electronic stethoscope enables recording of respiratory and heart sounds by doctors, medical personnel and ordinary people. It is intended for adult, pediatric and infant patients, for both home and professional use.

### Examination quality control

The system helps carry out the examination correctly: a step by step tutorial will guide you.

### Easy contact with a doctor

Enables remote consultation sharing data with your doctor via e-mail or Social applications.

### Noise control

It detects and automatically monitor excessive noise in the room, that might impact the results.

### Automatic start/stop

Records sounds automatically once the stethoscope is put to the body correctly. The device does not analyze the recorded sounds. It operates with built-in Lithium battery.

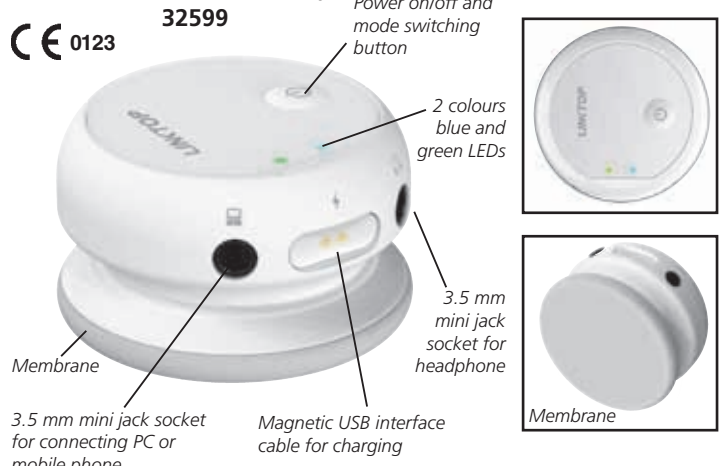

STANDARD ACCESSORIES	
Mini jack 3.5 mm headset	
Mini jack 3.5 mm - mini jack 3.5 mm cable	
Magnetic USB charging cable	
User manual: GB, FR, IT, ES, DE	

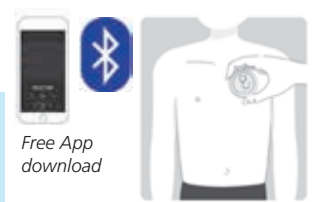

TECHNICAL SPECIFICATIONS	
Operating mode:	continuous
Battery:	Built-in lithium-ion battery (non-removable) - 200mAh Power: 3.3-4.2V Charging voltage/current: 5V DC / 500mA Charger: magnetic USB
Diaphragm:	Diameter: 43.8 mm Material: polyurethane-coated silicone, non-chill diaphragm cover Type: digital electronic filtering, ambient noise reduction
Sound:	Transmission: via Bluetooth, headphone and recording cable Frequency range: 20-3 KHz Amplification: up to 24 X 85% ambient noise reduction
Auscultation mode:	remotely via Homedoctor System or via 3.5 mm headset
Size - Weight:	Ø 45 x h 26.1 mm - 62 g
Protection class:	Ila type BF, IP22.
Norms:	EN 60601-1: 2006+A11: 2011+A1: 2013+A12: 2014, EN 60601-1-2: 2015

# GIMA 5 IN 1 MULTIFUNCTIONAL HEALTH MONITOR



**5 in 1**  
 Temperature  
 Blood pressure  
 SpO<sub>2</sub>  
 ECG  
 Respiration



Blood Pressure Measurement

Download Health monitor App via:



• **35192 GIMA 5 IN 1 MULTIFUNCTIONAL HEALTH MONITOR**  
 Gima Health Monitor 5 in 1 is a small and portable multifunctional device, intended for measurement of 5 vital signs: temperature, blood pressure, blood oxygen, ECG heart rate and respiration rate.

Gima Health Monitor works with wireless connection for data transmission to a mobile phone application, where measurements are recorded and stored.

The device has infrared and pressure sensors to collect information. Health monitor free App (GB, IT)  
 Supplied with magnetic detachable arm cuff, USB charging cable, multilingual manual (GB, FR, IT, ES, DE).

• **35193 CUFF 22-35 cm - spare**



Blood oxygen measurement

ECG recording

Body temperature measurement

## TECHNICAL SPECIFICATIONS

<b>Blood pressure Heart Rate</b>	
Measuring method:	oscillometric
Cuff size:	22-35 cm
Measuring range:	0-300 mmHg ±3 mmHg Heart rate: 40-180 bpm ±5% Systolic pressure: 60-230 mmHg Diastolic pressure: 40-130 mmHg
<b>ECG</b>	
Measurement mode:	Single lead
Input impedance:	≥100 KΩ; Input circuit current: <0.1 μA
Calibration voltage:	1 mV ±0.05 mV
Sensitivity tolerance:	< 10%
50Hz interference suppression filter:	> 20 dB
Maximum input range:	±4.5 mV
Polarization resistance voltage:	±300 mV
Amplitude variation:	< 10% Frequency response: 0.5-40 Hz

<b>Blood oxygen</b>	
Measuring method:	reflective
Method Measuring range:	90-99% ±2%
<b>Temperature</b>	
Measuring method (forehead):	infra-red
Measuring range:	28-42°C
Accuracy:	35-42°C ±0.3°C; <35°C ±0.4°C
<b>Device</b>	
Power voltage:	DC3.7V
Built-in battery:	rechargeable lithium-ion
Battery life:	500 measurements
Size - weight:	70x70x18.4 mm - 70g
Wireless communication:	Bluetooth 4.0
Working frequency:	2.4000-2.4835 GHz
Electric shock protection:	BF-style applied part



# GIMA OTOSCOPE WITH CAMERA

• **35195 GIMA OTOSCOPE WITH CAMERA - Android**  
 • **35196 GIMA OTOSCOPE WITH CAMERA - Android + iOS**  
 Portable, handheld optical magnifying device with short focal length camera, intended for the examination of the ear, external auditory canal and tympanum.

The high resolution camera can provide great images and videos, there are 6 LED lights on the top of the camera which light the path and increase the visual field.

It has rechargeable battery and different connecting cables, based on phone type.

By connecting the otoscope to the App, videos and still images can be captured, transmitted and visualized on the device.

It is suitable for adults and children over 3 years old.

• **35197 SILICONE SPECULA for 35195-6 single patient - box of 50**

	<b>TECHNICAL SPECIFICATIONS</b>
<b>Camera:</b>	Diameter: 3.9 mm Pixel: 1,000,000 pixels Resolution: 720 p Focal length: 1.5~2.0 cm Horizontal viewing angle: (FOV) 70° Frame rate: 15 fps
<b>Power supply:</b>	Lithium-ion battery (non-removable)
<b>Battery life:</b>	More than 500 charging cycles
<b>Charging voltage/current:</b>	5V DC 2A/1A/500 mA
<b>Dimensions - weight</b>	134.5x Ø 17.8 mm (5.3xØ 0.7 inch) - 24.5 g
<b>Classification:</b>	BF type application part
<b>Protection class:</b>	IP22

## COMPATIBILITY

Mobile phone and tablets: Android 6.0 or higher (35195-6)  
 Iphone: iOS 9.0 or higher (35196 only)



**35195**

- Cover: automatic on/off by opening and closing the cover
- CE
- Camera: for video shooting and photos taking.
- Reset hole: for resetting the device by inserting a thin rod to press the reset key
- 6 LED lights: lighting for camera imaging, non-removable
- Indicator light: two colour LED light, used to indicate operation, charging and low power status
- Magnetic USB interface: for connecting and charging cable, Android/ iOS device
- Internal ear visualization

**STANDARD ACCESSORIES**

- 1 Magnetic USB-C cable,
- 1 Magnetic iOS cable,
- 1 Micro USB adapter cable,
- 1 Magnetic USB charging cable,
- 1 Adaptor for tongue depressor
- Multilingual manual (GB, FR, IT, ES, DE).

## CHECKME™ LITE HEALTH MONITOR WITH BLUETOOTH

- **35185 CHECKME™ LITE HEALTH MONITOR with bluetooth**  
Innovative all-in-one device with multiple functionalities into one compact and portable unit. It allows to measure simultaneously ECG, heart rate, QRS duration, SpO<sub>2</sub>, pulse rate and pulse index. With colour touch screen, well organized user interface and audio instructions, is very intuitive and easy to use. Clinical approved accuracy.  
- supports both cable and cable-free measurement of ECG and SpO<sub>2</sub> (optional cable)  
- checks, captures and identifies abnormal ECG in 20 sec.  
- professional ECG algorithm provides heart rate, QRS duration, ST segment and rhythm analysis  
- check blood oxygenation with built-in SpO<sub>2</sub> sensor in 20 sec  
- high quality ECG waveform can be saved and replayed  
- professional PC data management software for review and generating reports (compatible with windows OS) MyBeats Hub App.
- **35190 EXTERNAL SpO<sub>2</sub> ADULT SENSOR - reusable - optional**

**DAILY CHECK  
JUST TAKES  
20 SECONDS**



**ECG + HR + SpO<sub>2</sub> +  
QRS + Pulse Rate + PI**

Manual: GB, IT, ES, DE, FR  
Audio instructions:  
GB, PL, DE, IT, FR, ES, HU  
PC software: GB



Size: 88x56x13 mm Weight: 64 g

**STANDARD ACCESSORIES**

- PC software: GB
- ECG cable
- ECG electrodes
- Neck strap
- Charging cable, micro D

## CHECKME™ PRO VITAL SIGNS MONITORS - WIRELESS WITH BLUETOOTH

- **35186 CHECKME™ PRO VITAL SIGNS MONITOR - with Bluetooth**
- **35187 CHECKME™ PRO VITAL SIGNS MONITOR WITH ECG HOLTER - with Bluetooth**  
All-in-one, compact, versatile and portable wireless vital signs monitors for checking your health anytime anywhere. Wide range of application scenarios, including: outpatient, emergency, surgeries, telemedicine. MyBeats Hub App.
- **35188 AIR BP BLOOD PRESSURE UNIT\* - optional**
- **35189 AIR BP BLOOD PRESSURE UNIT\* WITH DISPLAY - optional**  
Ultra-portable upper arm blood pressure device. See below.  
*\*Includes main unit, cuff and charge cable*
- **35190 EXTERNAL SpO<sub>2</sub> ADULT SENSOR - reusable - optional**

**CHECKME™ PRO FEATURES**

- ECG**
- supports both cable and cable-free operation
  - 500 Hz sampling rate and wide bandwidth
  - 30/60s waveform can be replayed
  - professional ECG algorithm to provide Heart Rate, QRS duration, ST segment, QT/QTc interval, and rhythm analysis **ECG holter (only 35187)**
  - easy to wear and use
  - continuously record ECG for 24 hours
  - check report and ECG waveform on APP or PC
  - the report includes heart rate, rhythm and HRV (heart rate variability)
  - holter report can be stored in Cloud, printed or saved as PDF



- SpO<sub>2</sub>**
- supports both cable and cable-free operation
  - measurement of oxygen saturation, pulse rate and pulse strength
- Sleep apnea screening**
- SpO<sub>2</sub> monitor for OSA (Obstructive Sleep Apnea)
  - records and tracks SpO<sub>2</sub> and Pulse Rate up to 10 hours
  - mobile APP to check SpO<sub>2</sub> change in details
- Blood Pressure via Bluetooth (needs code 35188 or 35189)**
- manage all vital signs data together - see below
- Temperature - Integrated infrared temperature sensor**
- quick measurement with high accuracy
  - safe and comfortable, no need to wake up child while sleeping

- Pedometer**
- accurately calculate steps, calories and amount of fat burned
  - built-in high accuracy 3D smart sensor
- APP - support iOS and Android**
- built-in Bluetooth, all data can be exported from device to phone/tablet
- PC browser**
- medical data management software
  - user data, user profile, readings and wave form can be exported from Checkme to the browser by USB



Size: 88x56x13 mm  
Weight: 80 g

**ECG + SpO<sub>2</sub> +  
BP (needs 35188-9)  
+ Sleep Apnea +  
Temp + Pedometer  
+ 24 hours ECG  
holter (only 35187)**

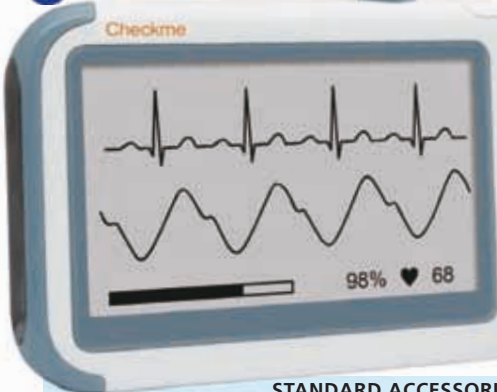

**STANDARD ACCESSORIES**

- ECG cable, SpO<sub>2</sub> sensor, ECG electrodes, charge cable, neck strip, user manual, protective cover, wrist band, Y adaptor and sport chest band (only 35187)

Manual: GB, ES, IT, DE, FR  
Audio instructions: GB, ES, IT, DE, FR, PL, RU, HU  
Pc software: GB  
App: GB, DE, FR, ES

## AIR BP ULTRA-PORTABLE SMART BLOOD PRESSURE MONITOR

- **35188 AIR BP BLOOD PRESSURE UNIT**
- **35189 AIR BP2 BLOOD PRESSURE UNIT WITH DISPLAY**  
Ultra-portable smart upper arm blood pressure device.  
- one battery charge for 1000 measurements  
- easy to use, robust and durable  
- professional measurement  
- readings:  
- systolic, Diastolic, Pulse Rate;  
- pulse Pressure, MAP (Mean Arterial Pressure)  
- irregular heartbeat  
- work with Smartphone  
- real-time Virtual Mercury Column in App during measurement  
- real-time Pulse Waveform

- multi-patient Management
  - unlimited recording
  - works with Checkme Pro 35186, 35187.
- Supplied with cuff, charge cable and multilingual manual (GB, FR, IT, ES, DE).



**TECHNICAL SPECIFICATIONS**

- |                             |  |
|-----------------------------|--|
| Cuff:                       | Upper arm circumference: 22-42cm             |
| Wireless:                   | Bluetooth 4.0 BLE                            |
| Charge input:               | Micro USB, DC 5V                             |
| Battery life:               | 1000 measurements, rechargeable              |
| Pressure measurement range: | 0-300 mmHg ±3 mmHg                           |
| Pulse rate:                 | 40 to 200 bpm ±2 bpm                         |
| Mobile App for iOS:         | iOS 9.0 or above, iPhone 4s/iPad 3 or above  |
| Mobile App for Android:     | Android 4.4 or above, with Bluetooth 4.0 BLE |
| Size - weight:              | 68x20 mm (main unit) - 30g (main unit)       |
| Clinical accuracy:          | meet IEC 80601-2-30                          |



35189

Smartphone not included

# PC-300 SPOT CHECK BLUETOOTH MONITOR

**Standard:**  
SpO<sub>2</sub>, PR, NIBP, TEMP

**Optional ECG, GLUCOMETER**

FDA 510 (K)  
CE 0476



Size:  
165x96x68 mm

Memory of  
6,000 NIBP measures



Bluetooth 2.0  
and 4.0 standard



## • 35162 PC-300 SPOT CHECK MONITOR

PC-300 handheld Spot-check monitor measures SpO<sub>2</sub>, Pulse Rate, NIBP and TEMP. Widely used in hospitals, clinics and family daily measurement. Equipped with Bluetooth and USB interface, allows to transfer data to PC, tablets and smartphone (Android and iOS).

- up to 6000 groups NIBP data storage, up to 100 different patients (each user can store 999 measurement records)
- quick ear probe TEMP measurement result in 5 seconds
- data transfer to PC/Smartphone by USB or Bluetooth
- optional NIBP pediatric cuff and SpO<sub>2</sub> pediatric probe
- optional ECG and Glucometer
- built-in rechargeable lithium battery
- communication protocols available on request



### STANDARD ACCESSORIES

- SpO<sub>2</sub> adult probe
- NIBP adult cuff
- Ear thermometer (probe covers not included)
- Lithium battery with charger
- Carrying bag
- User manual: GB, FR, IT, ES

### TECHNICAL SPECIFICATIONS

<b>SpO<sub>2</sub></b>	Measuring range:	0-100%
	Accuracy:	±3% (70-100%)
<b>Pulse Rate</b>	Measuring range:	30-240 bpm
	Accuracy:	±2% or ±2 bpm (whichever is greater)
	<i>*Root-mean-square value of deviation according to ISO 80601-2-61, ISO 9919</i>	
<b>NIBP</b>	Pressure range:	0-300 mmHg (0-39.9kpa)
	Accuracy:	±3 mmHg
	Measuring range:	Systolic pressure: 30-270 mmHg Diastolic pressure: 20-235 mmHg MAP: 10-220 mmHg
<b>TEMP</b>	Measuring range:	32-43.0°C
	Accuracy:	±0.2°C (36-39°C) - ±0.3°C (other)
	Measuring time:	<5 s
<b>ECG (Optional)</b>	Heart Rate measuring range:	30-240 bpm
	Heart Rate accuracy:	±2 bpm or ±2% whichever is greater
	Display scale:	5.0 mm/mV ±10%
	Common-mode rejection ratio (CMRR):	≥60 dB
<b>Blood Glucose (Optional)</b>	Measuring range:	20 to 600 mg/DL
	SEE other specification at page 1	
<b>Power Supply</b>	Battery:	3.7 V built-in Li-ion battery
	Operating voltage:	3.6-4.2 VDC
	Operating current:	≤800 mA
	Charger:	100 - 240 VAC, 50/60 Hz, 5 VDC or USB

GIMA code	PC-300 ACCESSORIES	
35164	SpO <sub>2</sub> pediatric probe - optional	
35165	SpO <sub>2</sub> adult probe - spare	35165
35166	NIBP pediatric cuff 10-19 cm - with extension cable - optional	
35167	NIBP adult cuff 22-30 cm - spare	35167
35168	NIBP adult large cuff 27-42 cm	
35169	NIBP adult extra large cuff 40-48 cm	
35170	Ear infrared thermometer	35170
35171	Ear probe cover - box of 500	
35172	Lithium battery - spare	
35173	Carrying case	
<b>PC-300 ACCESSORIES: glucose and ECG (optional)</b>		
24108	GIMA Glucose monitor* - GB, IT, SE, FI	24108, 24110-1, 24114
24110	GIMA Glucose monitor Kit* - IT, ES	
24111	GIMA Glucose monitor Kit* - GB, FR	
24114	GIMA Glucose monitor Kit* - Bluetooth - GB, IT	
24118	Glucose strips - box of 25	
24119	Glucose strips - box of 50	
24120	Glucose strips - box of 100	
35176	USB cable for On Call Plus II glucose monitor	
35177	USB cable for Gima glucose monitor (24108/10/11/14)	
35178	ECG module** needs 33248	
33248	ECG pin lead cable 3 leads	33248

See glucose monitor accessories at page 1 See electrodes at page 333-334  
\*Needs USB cable 35176 to connect to PC-300 \*\*ECG module can be used without 3 leads cable in palm mode

# ARMFIT+ BLOOD PRESSURE MONITOR WITH ECG



## • 35198 ARMFIT+ BLOOD PRESSURE MONITOR WITH ECG

Armfit+ is intended to be used for real time monitoring, measuring, displaying, reviewing and storing ECG and blood pressure variations, at home or healthcare facilities. ECG can be recorded without cable only. Built-in Bluetooth wireless connectivity allows to share measurement records to mobile phones and tablets. Supplied with one adult cuff, charging cable, quick guide and multilingual manual in GB, FR, IT, ES, DE.

### ECG RECORDING WITHOUT CABLE

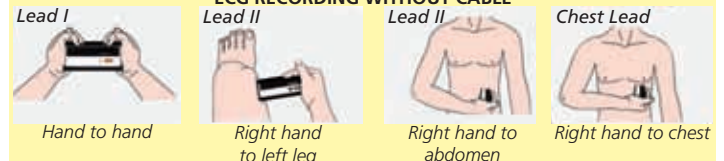

### TECHNICAL SPECIFICATIONS

<b>Blood Pressure Measurements</b>	<b>ECG Recording</b>	<b>Wireless:</b>	<b>Built-in Bluetooth 4.0</b>
Technology:	Lead type:	Charge input:	Micro USB, DC5V
Pressure measurement range:	Lead set:	Battery type:	Rechargeable lithium-polymer
Accuracy:	ECG measurement:	Battery run time:	500 measurements
Pulse rate range:	Heart rate range:	Charge time:	2 hours
Pulse rate accuracy:	ECG records:	<b>Classifications</b>	
Clinical accuracy:	<b>Device</b>	Protection:	Type BF
Blood pressure records:	Size - weight (main unit):	Dust & water resistance:	IP22
	Cuff size:	Norms:	EN 60601-1-2

# GIMA BLUETOOTH BLOOD PRESSURE MONITOR



32916 Size 131x73x29.4 mm



Irregular Heartbeat Detection



Bluetooth Version



Excessive Body Motion Detector



2x60 Groups of Memory



### COMPATIBILITY

For iOS devices: The operating system must be iOS 8 or more, such as iPhone 4S, iPhone 5/5C/5S, iPhone 6/6 Plus and so on.  
For Android devices: The operating system must be 4.3 or more

- **32916 GIMA BLUETOOTH BLOOD PRESSURE MONITOR** Bluetooth BPM with innovative tubeless technology and super slim design. It measures blood pressure and heart rate, irregular heartbeat detection and excessive body motion.
- Large LCD display 86x24 mm, blue mode display with backlight
- comfortable cuff for arm circumference 22x42 cm (nylon outside + polyester inside in contact with skin)
- date, time and low battery indication
- 2 groups of memory (2 users)

Multilingual box and manual: GB, FR, IT, ES.

### TECHNICAL SPECIFICATIONS

Measuring method: Oscillometric - continuous mode operation  
Measurement range: Rated cuff pressure 0~299 mmHg  
Measurement pressure: SYS: 60~230 mmHg, DIA: 40~130 mmHg  
Pulse: 40-199 bpm  
Mechanical buttons: User 1 - User 2 - Query - Power  
Power supply: 3.7V - 1000 mA built-in rechargeable li-polymer battery - battery life 2 years up to 300 times  
Charge power: AC Adaptor (included): Input 100-240V, 50-60Hz

## RI-CHAMPION® SMART PRO+

• **49950 RI-CHAMPION® SMART PRO+ BLOOD PRESSURE MONITOR - 1735 - adult cuff**

• **49951 RI-CHAMPION® SMART PRO+ BLOOD PRESSURE MONITOR WITH BLUETOOTH - 1735 BT - adult cuff**

A clinically validated blood pressure monitor, designed for fast and reliable readings. Advanced performance with irregular heartbeat detection and averaging capabilities: analysis of 3 successive blood pressure measurements.

- Optional Bluetooth® connectivity (only 49951)
- fast and quiet operation for home and professional use.
- 200 measurements on one set of 4 AA batteries
- large, easy to read backlit screen
- meets EN1060-4, NIBP clinical investigation
- **49955 ADULT SMALL CUFF 15-24 cm - 12632 - optional**
- **49956 ADULT CUFF 24-43 cm - 12633 - spare**
- **49957 AC ADAPTER - 12631 - optional**



Air tube length: 80 cm



49950



Bluetooth® Connectivity (only 49951)

### TECHNICAL SPECIFICATIONS

Heart Rate Range: 40-199 beats/minute  
Systolic Measurement Range: 60-255 mmHg  
Diastolic Measurement Range: 30-195 mmHg  
Pulse Rate Measurement Range: 40-199 beats / minute ±4% of reading  
Maximum Inflation Pressure: 280 mmHg ±3 mmHg or ±2% of reading  
Power Source/Supply: 4x 1.5 V AA alkaline batteries / DC + 6 V / 1 A  
Battery Life: 200 Readings  
Memory: maximum 400 memory records  
Size - weight: 141x121xh 72 mm - 350g\* \*without battery



## ADULT AND PEDIATRIC B.P. MONITOR WITH SpO<sub>2</sub> OPTION

Supplied with large cuff, USB cable, software and multilingual manual (GB, FR, IT, ES, PT)



32902



PC software for data review, result analysis, trend chart observation and report print

• **32902 LEO ELECTRONIC SPHYGMOMANOMETER - with software**

Electronic sphygmomanometer for fully automatic measurement of blood pressure provided with large, high definition colour LCD display.

- data storage (3 users) for up to 100 groups of data
- automatic one-touch operation
- alarm function with possibility to set alarm limits
- dual scales: kPa and mmHg
- automatic power off
- selection of five cuff sizes
- optional SpO<sub>2</sub>

• **80556 POWER ADAPTOR**

### TECHNICAL SPECIFICATIONS SpO<sub>2</sub>

SpO<sub>2</sub> range: 0%-100% (resolution 1%) ± 2% (70% - 100%)  
PR range: 30-250 bpm, (resolution 1 bpm) ± 2 bpm or ± 2% (select larger)

GIMA code	SpO <sub>2</sub> PROBES
32903	SpO <sub>2</sub> reusable adult probe with 1.5 m cable
35107	SpO <sub>2</sub> reusable neonatal probe*
35109	SpO <sub>2</sub> disposable neonatal** and adult** probe*
32917	Extension cable for 35107, 35109 to 32902

\*Need extension cable 32917 \*\*Neonatal below 3 kg and adult over 40 kg

GIMA code	CUFFS	Size	Suitable for
80551	Small	6-11 cm	Child small
80552	Small/medium	10-19 cm	Child
80553	Medium	18-26 cm	Adult
80554	Large	25-35 cm	Adult large
80555	X-Large	32-43 cm	Adult extra large

**TECHNICAL SPECIFICATIONS SPHYGMO**  
Measurement method: oscillometric  
Measurement range: 0-39.6 kPa (0-297 mmHg) Resolution: 3 mmHg  
Accuracy: static pressure: ±0.4 kPa (±3 mmHg)  
Inflation - Deflation: automatic inflation - automatic multistep deflation  
Display: 2.8" colour LCD screen, USB interface  
Power: four "AA" batteries or optional power adapter  
Safety: class II device type BF applied part  
Dimension - Weight: 130x110x80 mm - 300 g



# iHEALTH WIRELESS PERSONAL HEALTHCARE PRODUCTS

## iHEALTH MYVITALS APP - free

- track data, graphs and history
  - multi-patient App (sort measurements data per users)
  - free and secure data storage
  - share results with your healthcare professional
- To manage wireless:

- 1 iHEALTH PULSE OXIMETER - page 391
- 2 iHEALTH BODY ANALYSIS SCALE - page 94
- 3 iHEALTH B.P. MONITOR - ARM
- 4 iHEALTH B.P. MONITOR - WRIST

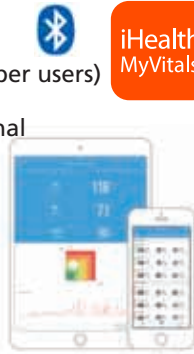

iHEALTH products to manage your personal health Bluetooth connectivity for iPad, iPhone, iPod and Android system, allow to easily measure and track personal data and share instantly with family or doctor. The powerful iHealth MyVitals App will also allow to manage all your health data with custom graphs, statistics, trends and tracks the relation among various parameters such as blood pressure, weight, calorie intake and activities. App compatible with all Apple and Android platforms. Includes a free iHealth Cloud service. iHealth MyVitals App available in: GB, FR, IT, ES, DE, NL, GR, HU, PT, RO, RU, TR, JP, KR, CN, AR. 2 years warranty.



## 3 iHEALTH TRACK CONNECTED ARM BLOOD PRESSURE MONITOR



Dual use: traditional use or use with smartphone

Universal cuff (22-42 cm)



For iOS and Android version 4.4 +  
See the list of compatible devices on [ihealthlabs.eu/support](http://ihealthlabs.eu/support)

- 23499 iHEALTH TRACK CONNECTED ARM B.P.M.
  - clinically validated blood pressure (ESH)
  - systolic, diastolic and heart rate (number of beats per minute)
  - evaluation of measurements as recommended by the WHO
  - detection of arrhythmia
  - colour changing display
  - easy to use and comfortable
  - 60 memories
  - one-Click: save all your measurements in MyVitals App account
- Multilingual box and manual: GB, FR, IT, ES, DE, GR, PT, NL.
- iHEALTH MyVitals App:**

- track data, graphs and history on the iHealth MyVitals App
- add measurement reminders, free and secure data storage
- share results with friends or healthcare professionals
- 23497 ADULT CUFF - 22-42 cm - spare
- 23498 OBESE CUFF - 42-48 cm

### TECHNICAL SPECIFICATIONS

Connectivity: Bluetooth 4.0	Power: 4x1.5V size AAA batteries
Size: 98x98x46 mm	Battery life: 250 measurements
Cuff circumference: 22-42 cm	Range: Sys: 60-260 mmHg,
Weight: 438 g (cuff + batteries included)	Dia: 40-199 mmHg
Measuring method: Oscillometric, with automatic inflation and deflation	Pulse rate range: 40-180 bts/min

## 3 iHEALTH ARM B.P. MONITORS



Smart and thin blood pressure monitor with direct visualization on its LED screen of the last blood pressure measurement



European Society Hypertension



23495

Easily saves all your measurements into the iHealth MyVitals App thanks to Bluetooth 4.0 synchronization

Weight: 232 g

- 23495 iHEALTH NEO BP5S ARM B.P. MONITOR - with display
  - medically validated blood pressure monitors
  - easy to read wide Backlit screen
  - measurement of blood pressure (systolic, diastolic) and of heart rate (number of beats per minute)
  - detection of arrhythmia
  - multiple users and unlimited memories
  - view historical readings and WHO classification
- Multilingual box and manual: GB, FR, IT, ES, DE, GR, PT, NL.

### TECHNICAL SPECIFICATIONS

Connectivity: Bluetooth 4.0
Dimensions: 135x55x12 mm
Screen dimensions: 30.4x27.8 mm
Cuff circumference: 22-42 cm
Measuring method: Oscillometric, with automatic inflation and deflation
Power: DC: 5 V, 1.0 A, 3.7 V, Li-ion battery
Range: Sys: 60-260 mmHg ±3 mmHg
Dia: 40-199 mmHg ±3 mmHg
Pulse: 40-180 bts/min



23500

## 4 iHEALTH WRIST B.P. MONITORS



European Society Hypertension



23501

23502

Motions Sensor Technology: does not allow to take BP in case BP monitor is not correctly positioned

- 23501 iHEALTH SENSE BP7 WRIST B.P. MONITOR
  - 23502 iHEALTH VIEW BP7s WRIST B.P. MONITOR - with display
  - medically validated blood pressure monitor
  - easy to read wide Backlit screen (only 23502)
  - measurement of blood pressure (systolic, diastolic) and of heart rate (number of beats per minute)
  - detection of arrhythmia
  - best wrist position sensor for optimum measurement
  - evaluation of measurements as recommended by the WHO\*
- Multilingual box and manual: GB, FR, IT, ES, DE, GR, PT, NL.

### TECHNICAL SPECIFICATIONS

Connectivity: Bluetooth 4.0	Weight: 120 g
Dimensions: 72x74x17.6 mm	
Screen dimensions: 44x26 mm	
Cuff circumference: 13.5-22 cm	
Measuring method: Oscillometric, with automatic inflation and deflation	
Power: DC: 5 V, 1.0 A, 1x3.7 V, Li-ion 400 mAh	
Range: Sys: 60-260 mmHg	
Dia: 40-199 mmHg	
Pulse: 40-180 bts/min	



23502

\*World Health Organization

## 24-HOUR ABPM, SpO<sub>2</sub> AND PULSE RATE AMBULATORY MONITOR

- 35110 GIMA ABPM + Pulse rate with software
  - 35112 GIMA ABPM + Pulse rate with software and Bluetooth
  - 35111 GIMA ABPM + Pulse rate + SpO<sub>2</sub> with software
- GIMA ABPM module measures the blood pressure using the oscillometric method with step deflation. Two modes of measurement: manual and automatic. Each mode displays the diastolic, systolic and mean blood pressure. In the MANUAL mode, only one measurement is conducted for each time. In AUTO mode, the measurement is cycled and can be set at intervals: 5/10/15/20/30/45/60/90 min. (35111), 15/30/60/120/240 min. (35110), 15/20/30/40/60/90/120/240 min (35112).
- compact and portable, easy to use
  - suitable for adult, pediatric and neonatal patient
  - large colour LCD display of ABPM, SpO<sub>2</sub> and pulse rate
  - adjustable audible and visual alarms
  - real-time ambulatory monitoring 24 hours storage and review of date
  - clinically proven accuracy
  - all data can be transferred to a PC through Windows-based software or to a smartphone through Bluetooth (35112 only).
  - 35113 CHILDREN CUFF - arm circumference 18-26 cm - spare
  - 35114 ADULT CUFF - arm circumference 25-35 cm
  - 35115 ADULT LARGE CUFF - arm circumference 33-47 cm
  - 35116 THIGH CUFF - thigh circumference 46-66 cm
  - 35117 EXTENSION TUBE FOR CUFFS (35113/4/5/6) - 1.5 m - spare
  - 35118 ADULT SpO<sub>2</sub> PROBE - reusable - spare
  - 35119 CARRYING BAG - spare

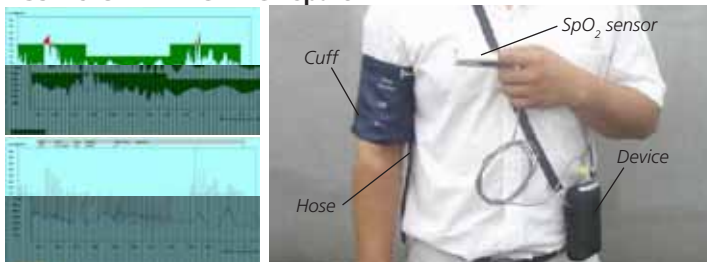

### STANDARD ACCESSORIES

- |  |   |
|--|---|
| Carrying bag   | Software (GB, FR, IT, DE, ES, PL, RO, SK, TR, RU) |
| 3 nylon cuffs (pediatric, adult, adult large) - latex free |   |
| SpO <sub>2</sub> probe (only code 35111)                   | Cuff connection tube 1.5 m                        |
| User manual: GB, IT, FR, ES, DE                            | Alkaline batteries                                |

\*Only for 35110, 35112

### TECHNICAL SPECIFICATIONS

<b>SpO<sub>2</sub> (35111 only)</b>	Alarm: systolic 40-270 mmHg
Measurement range: 0-100%	diastolic 20-235 mmHg
Resolution: 1%	Map 10-270 mmHg
Accuracy: 70-100% ±2%	(35111 only)
Alarm range: 0-100%	
<b>NIBP</b>	<b>Pulse rate</b>
Method: oscillometry	Range: 0-250 bpm (35111)
Mode: manual/automatic/continuous	40-240 bpm (35110, 35112)
Measurement range: 0-290 mmHg	Resolution: 1 bpm
(0 KPa - 38.67 KPa)	Accuracy: ±1 bpm
Automatic measurement interval:	Alarm range: 30-250 bpm
5, 10, 15, 30, 45, 60, 90, 120 min. (35111)	<b>Device</b>
15, 30, 60, 120, 240 min. (35110),	Display: colour LCD
15/20/30/40/60/90/120/240 min (35112)	Power: two "AA", 1.5V alkaline batteries
Resolution: 1 mmHg	Dimension: 128x69x36 mm
Overpressure protection: 290 mmHg	Weight: <350 g (including batteries)
	<b>Operating system</b>
	Windows XP/Seven, 8, 8.1, 10
	(at 32 & 64 bit)

## RIESTER RBP-100 BLOOD PRESSURE MONITOR

- 49960 RIESTER RBP-100 B.P. MONITOR - 1740 - table
  - 49961 RIESTER RBP-100 B.P. MONITOR - 1741 - trolley
- Clinical grade digital blood pressure monitor for fast and reliable readings. Clinically validated to international standards BHS, ESH, AAMI. Clinically validated for patients with special conditions: hypertension, diabetes, pregnancy, pre-eclampsia, arteriosclerosis, end-stage renal disease, obesity, elderly and children > 3 years of age. Two measurement modes: auscultatory (manual) and oscillometric (automated). Auscultatory mode with auto-deflate (3 mmHg/sec) provides consistent patient BP measurement and allows clinicians to verify automated readings without removing the cuff. Average mode (3x readings) allows for a more objective measurement for clinicians and helps mitigate the risk of elevated readings due to white coat hypertension. Interval settings in average mode 15, 30, 45, 60 sec. It measures BP and pulse range, systolic, diastolic, heart rate and MAP.

- easy to read 4" LCD screen
  - arrhythmia detection
  - large memory: 210 readings
  - easy to use one touch operation
  - display panel with WHO Blood Pressure Value Classification (colour coded)
- Supplied with 2.5 m air tube, 2 cuffs (M and L-XL), NiMH battery pack, AC/DC adapter (EU, US, UK, Austr.). Multilingual manual (GB, FR, IT, ES, DE, RU)

- 49964 RIESTER CHILDREN VELCRO CUFF 14-22 cm with connector - 162 - optional



### TECHNICAL SPECIFICATIONS

Measurement mode: oscillometric, auscultatory	Cuff pressure: 0-310 mmHg
Measurement rate: systolic: 60-255 mmHg	Power supply: AC/DC Adapter 7.5V/1.5A
diastolic: 30-200 mmHg	NiMH AA 4.8V 2400 mAh
pulse: 40-200 bpm	rechargeable battery pack
static: ±3 mmHg	1.000 measurements per full charge
Accuracy: pulse: ±5%	Battery: 170x135x41 mm - 510g (device only)
Latex free cuffs: M: 22-32cm, L-XL: 32-52cm	Size - weight: 170x135x41 mm - 510g (device only)
	Certificates: ISO EN13485, Medical Device Class IIa

# MICROLIFE AFIB BLOOD PRESSURE MONITOR - STROKE PREVENTION

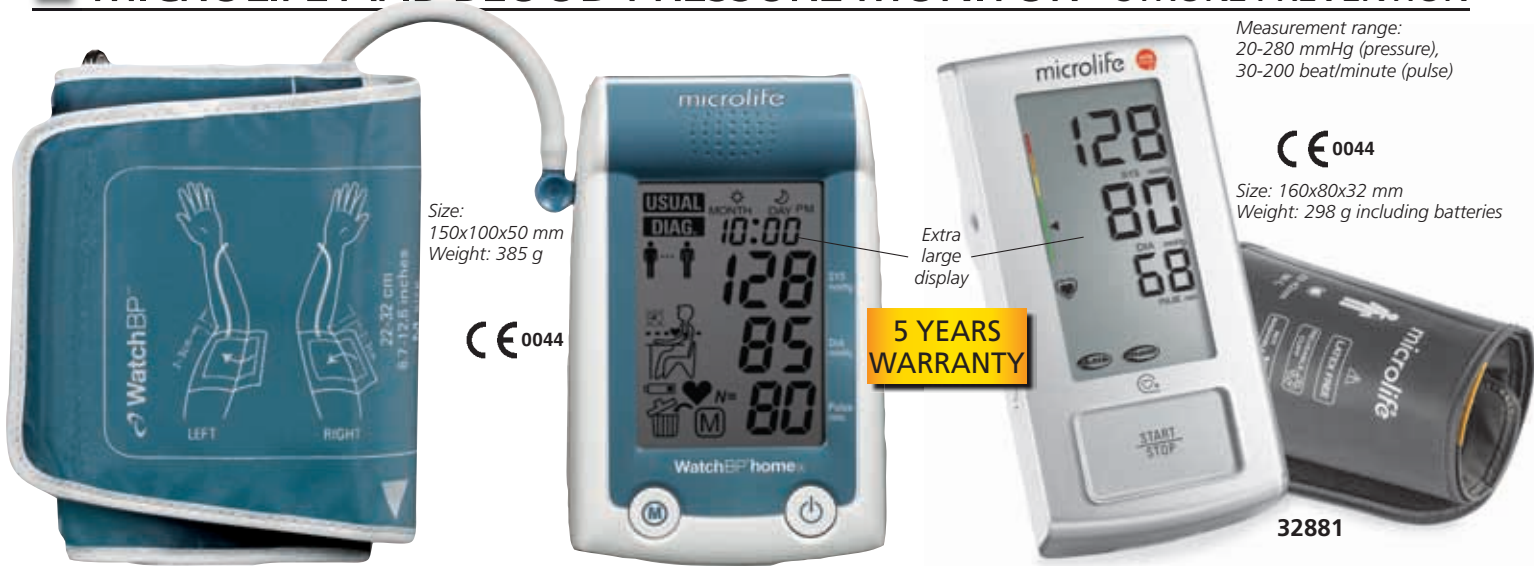

Size: 150x100x50 mm  
Weight: 385 g

CE 0044

Extra large display

5 YEARS WARRANTY

Measurement range:  
20-280 mmHg (pressure),  
30-200 beat/minute (pulse)

CE 0044

Size: 160x80x32 mm  
Weight: 298 g including batteries

32881

- **32868 MICROLIFE WatchBP Home A (Professional use) + SOFTWARE**
- detection of atrial fibrillation (specific heart arrhythmia)
- embedded ESH/AHA measurement guidelines lead to accurate home measurement data physician can trust in
- automated data tabulations displays averages for morning, evening and overall measurement
- clinically tested (BHS protocol)
- MAM technology (automatic analysis of 3 consecutive measurements)
- 250 Data memory in «USUAL» mode
- USB port and mains adapter port
- low battery indication
- 4x1.5 V AA batteries
- Supplied with carrying bag, USB cable, soft cuff 22-32 cm, software (GB) and manual (GB, IT, FR, DE). Other languages available from web (ES, DK, GR, FI, NL, NO, RU, SK, SE, UA).
- **32869 ADULT LARGE CUFF 32-42 cm**
- **32864 ADAPTER DC 6V, 600 mA**



microlife®

## DETECTION OF ATRIAL FIBRILLATION

### MICROLIFE AFIB technology

An innovative and patented technology for the early detection of Atrial fibrillation (AF) **More than 30,000 fatal strokes can be prevented within the European Union by using Microlife AFIB Technology in primary care** The new Microlife AFIB technology allows simultaneous blood pressure measurement and AF screening.

Microlife AFIB technology detects AF with high sensitivity (97-100%) and specificity (89%) as demonstrated in several clinical studies. Nice guidelines for "Diagnosis and assessment of hypertension" recommended to use AFIB screening for routine blood pressure measurement in primary care. AF screening by using a Microlife AFIB device is highly recommended in patients that have to monitor their blood pressure while at home.

- **32881 MICROLIFE AFIB ADVANCED EASY (Home use)**
- detection of atrial fibrillation (specific heart arrhythmia) with 1 measurement
- clinically tested according to the BHS - ISO - EHS protocols and for "special patients" such as Diabetics, Elderly, Obese, Hypotensive, Pregnant
- MAM technology (automatic analysis of 3 consecutive measurements)
- 1 Data memory
- traffic light indicator
- low battery indicator
- mains adapter port
- world's latest technologies
- Clinically reliable measurements with AFIB & MAM
- special deflation valve allows beat detection up to 30 b/min (for bradycardic patients)
- Supplied with carrying bag, preformed conical cuff 22-42 cm, 4 AAA batteries 1.5V and user manual (GB, FR, IT, DE).
- **32866 ADAPTER DC 6V, 600 mA**
- **32884 ADULT CUFF M-L 22-42 cm - spare**
- **32885 ADULT CUFF L-XL 32-52 cm**



# OMRON PROFESSIONAL B.P. MONITOR

- **32936 OMRON DIGITAL AUTOMATIC B.P. MONITOR HEM-907**
- Professional B.P. monitor designed for clinical use in professional settings.

MADE IN JAPAN

- gold standard accuracy
- validated according to international protocols:
- 1- Association for the Advancement of Medical Instrumentation (AAMI)
- 2- European Society of Hypertension
- International Protocol (ESH - IP)
- intellisense technology
- irregular pulse indicator
- 3 modes of operation: single mode, average mode, auscultation (manual mode).



Supplied with battery pack, adult cuff (22-32 cm), AC adapter.

- **32937 ADULT LARGE CUFF 32-42 cm**
- **32939 TROLLEY FOR OMRON HEM-907**

TECHNICAL SPECIFICATIONS	
Method:	Oscillometric
Measurement range:	pressure: 0-299 mmHg ± 3 mmHg or 2% pulse rate: 30-199 beats/min ± 5% of reading
Inflation:	automatic inflation with pumping
Deflation:	automatic deflation by electromagnetic control valve
Air release:	automatic rapid air release by electromagnetic control valve
Pressure detection:	electrostatic capacity semi-conductor pressure sensor
Power supply:	AC adapter (230 VAC, 50 Hz, 20 VA) Battery pack (4.8 VDC, 6W)
Electric shock protection method:	Class II B type
Dimension:	139x203x131 mm (5.1/2"x8"x5.1/6")
Weight:	approx. 910 g
Complies with:	EN 1060, EN60601-1-1 - 2007

32936  
+  
32939

CE 0197

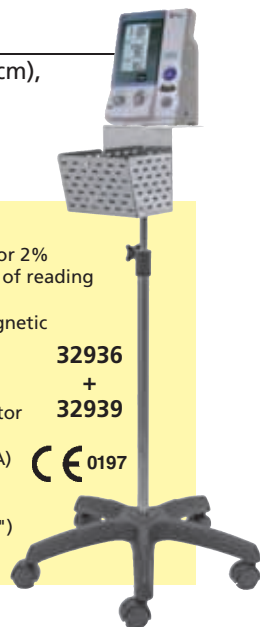

# OMRON BLOOD PRESSURE METERS - CLINICALLY VALIDATED



The Intellisense™ technology ensures that the right inflation pressure is automatically detected. It detects irregular pulses and automatically decides if the measurement result is reliable or needs to be repeated. Only accurate results are displayed.



CE 0197

49915

• 32949 OMRON M7 INTELLI IT - HEM-7322-T-E

• 49915 OMRON M7 INTELLI IT - HEM-7361T-EBK

With Intelli Wrap Cuff 22-42 cm.

The connection to OMRON App allows to monitor parameters, create personalized programs, download and share data. AFib (Atrial Fibrillation) detection function (only 49915).

FEATURES	M7	M6	M4	M3	M3	M2	RS7	RS4
	INTELLI IT	COMFORT	INTELLI IT	COMFORT	M3	M2	INTELLI IT	
Clinically validated*	X	X	X	X	X	X	X	X
Intellisense technology	X	X	X	X	X	X	X	X
Irregular heartbeats detector	X (AFib)	X (AFib)	X	X	X	X	X	X
Cuff wrap guide	X	X	X	X	X	X	X	X
Intelli Wrap Technology**	X	X	X	X			X	
Pre-formed cuff***: model size (cm)	Intelli wrap 22-42	Intelli wrap 22-42	Intelli wrap 22-42	Intelli wrap 22-42	Easy cuff 22-42	Cuff 22-32	Wrist 13.5-21.5	Wrist 13.5-21.5
Memory measurem. x user	100x2	100x2	60x2	60x2	60x2	30	100x2	60
Guest mode	X	X	X	X	X			
Body movement detection	X	X	X	X	X		X	X
Easy high blood pressure colour indicator****	X	X	X	X	X		X	X
Hypertension	X	X	X	X			X	X (morning)
Average last 3 measurements*****	X	X	X	X	X			
3 consecutive measurements in AFib mode	X	X						
Measurements comparison versus prior readings	X	X	X					
App/Bluetooth Connection	X		X				X	

\*To verify validations, please see [www.dablededucational.org](http://www.dablededucational.org)  
 \*\*360° accuracy: accurate measurements from any position around the upper arm  
 \*\*\*Pre-formed cuff, excluding M2, M3

\*\*\*\*Signal in case the values exceed the E.H.S. standards for domiciliary auto-measurements (85 systolic pressure and/or 135 diastolic pressure)  
 \*\*\*\*\*Average of 3 last measurements made within 10 min



49905

49906

49908

49910

• 49905 OMRON M3 HEM-7154-E  
With Easy cuff 22-42 cm.

• 49906 OMRON M3 COMFORT HEM-7155-E  
With Intelli Wrap Cuff 22-42 cm.

• 49908 OMRON M4 INTELLI IT HEM-7155T-EBK

With Intelli Wrap Cuff 22-42 cm. It monitors hypertension at home and automatically updates and transfers results to smartphones by Bluetooth on OMRON App.

• 49910 OMRON M6 COMFORT - HEM-7360-E

With Intelli Wrap Cuff 22-42 cm. It detects the possibility of Atrial fibrillation, enabling home monitoring. It also takes 3 consecutive readings at 30 second intervals, then displays the average to give more accurate indication of blood pressure.



49902

• 49902 OMRON M2 HEM-7143-E  
With cuff 22-32 cm.

It has unique Intellisense™ Technology and features Irregular Heartbeat Detection. One-touch design and large display.

**MULTILINGUAL BOX AND MANUAL**  
 Standard languages: GB, FR, IT, ES, DE, NL, RU, TR, Arabic  
 Other languages: available on Omron website



	TECHNICAL SPECIFICATIONS			
	49902 M2	49905 M3 49906 M3 COMFORT	49908 M4 INTELLI IT	49910 M6 COMFORT 49915 M7 INTELLI IT
Measuring method:	oscillometric			
Measuring range: Pressure:	0 mmHg to 299 mmHg ± 3 mmHg			
Pulse:	40 to 180 min ± 5% of display reading			
Memory (with date and time):	30	60x2 users	60x2 users	100x2 users
Inflation:	fuzzy logic controlled by electric pump			
Deflation:	automatic pressure release valve			
Rating:	DC 6V 4W	6VCC 4W		
Power source:	4 "AA" batteries 1.5 V			
Battery life (N° of measurements):	1000			
Protection against electric shock:	internally powered ME equipment (when using batteries)			
Weight (console+cuff) without batteries:	250+130 g	310+170 g*	340+163 g	460+163 g
Size:	103x129xh 80 mm	105x153xh 87 mm	105x152xh 85 mm	191x120xh 85 mm
Cuff materials:	nylon and polyester			
Measurable circumference (cm):	22-32 (arm)	22-42 (arm)	22-42 (arm)	22-42 (arm)

\*M3 Comfort weight 337+163 g

# OMRON EVOLV ALL IN ONE ARM BLOOD PRESSURE MONITOR

- **49900 OMRON EVOLV ALL IN ONE ARM BLOOD PRESSURE MONITOR**  
Easy to use, all in one upper arm blood pressure monitor takes accurate readings in any position around the upper arm and track progress via smartphone.
- All in one upper arm blood pressure monitor: no tubes, no wires, simply accurate
- **Intellisense Technology:** inflates the cuff to the ideal level
- **Intelli Wrap cuff:** for an easy and accurate reading
- **Clinically Validated:** proven reliability and accuracy under vigorous testing procedures by major health organisations.
- **Cuff Wrap guide:** indicates if the cuff is wrapped correctly, not too loose or too tight
- **OMRON connect App:** get connected, access anytime, see progress. Mobile application for iPhone / Android™.
- Supplied with battery set, storage case, manuals.
- Compatible with Alexa.
- Multilingual box and manual: GB, FR, IT, ES, DE, NL, RU, TR, Arabic.



**3 YEARS WARRANTY**



**OMRON**

49900



With standard cuffs, 1-in-3 people measure their blood pressure incorrectly. EVOLV's Intelli Wrap Cuff Technology ensures 360° accuracy in any position around your upper arm.



EVOLV can sync your readings to your smartphone to track results, monitor progress, and get a deeper understanding of your health. See smartphone compatibility list on [omronconnect.com/emealen\\_gb/](http://omronconnect.com/emealen_gb/)

### TECHNICAL SPECIFICATIONS

Cuff Type:	Intelli Wrap Cuff 22-42 cm
Memory:	100 Readings
Cuff Wrap Guide:	Yes
Irregular Heartbeat Detection:	Yes
Body Movement Detection:	Yes
Validation:	Clinical Validation, Pregnancy Validation
Intellisense Technology:	Yes
Stroke Prevention:	Yes
Size:	12x17.3x12.5 cm

# OMRON WRIST BLOOD PRESSURE MONITORS

32946



CE 0197

- **32946 OMRON RS4 HEM-6181-E - wrist**  
Led positioning sensor and cuff wrap guide indicate if the cuff is positioned correctly.
- Multilingual box and manual: GB, FR, IT, ES, DE, NL, RU, TR, Arabic.

49923



CE 0197

- **49923 OMRON RS7 INTELLI IT - HEM-6232-E - wrist**  
Intellisense technology makes measurement quick and comfortable. Advanced positioning sensor and cuff positioning guide for reliable measurements, which can be saved and tracked via Bluetooth through OMRON App.
- Multilingual box and manual: GB, FR, IT, ES, DE, NL, RU, TR, Arabic.



### TECHNICAL SPECIFICATIONS

	32946 RS4	49923 RS7
Measuring method:	oscillometric	
Measuring range:		
Pressure:	0 mmHg to 299 mmHg ± 3 mmHg	
Pulse:	40 to 180 min ± 5% of display reading	
Memory (with date and time):	60	100x2 users
Inflation:	automatic	
Deflation:	automatic	
Rating:	DC3 V 3.0W	
Power source:	2 "AAA" batteries 1.5 V	
Battery life (N° of measurements):	300	
Protection against electric shock:	internally powered ME equipment (when using batteries)	
Weight (console+cuff) without batteries:	86 g	91 g
Size (mm):	93x62xh 20	91x13xh 63
Cuff materials:	nylon and polyester	
Measurable circumference (cm):	13.5-21.5 (wrist)	

**OMRON**

# OMRON CUFFS AND ACCESSORIES



32933  
Standard cuff 22-32 cm



32938  
Easy adult cuff 22-42 cm



49920  
Intelli Wrap cuff 22-42 cm

GIMA code	OMRON code	ACCESSORIES	Size	Compatibility					
				M2	M3	M3 Comfort	M4 Intelli IT	M6 Comfort	M7 Intelli IT
32930	HEM-CS24-E	Small cuff	17-22 cm	•	•				
32933	HEM-CR24	Adult cuff	22-32 cm	•	•				
32938	HEM-RML31	Easy adult cuff	22-42 cm	•	•				
49920	HEM-FL31-E	Intelli adult wrap cuff	22-42 cm			•	•	•	•
32929		AC/DC adaptor - optional		•	•	•	•	•	•

Fits normal and large arms eliminating inaccurate readings associated with incorrect positioning. AFib indication function.

**OMRON**

## EASYCHECK DIGITAL B.P. MONITOR

### • 49880 EASYCHECK DIGITAL BLOOD PRESSURE MONITOR

LED screen electronic sphygmomanometer with simple interface to measure systolic, diastolic and mean blood pressure as well as pulse rate. NIBP records can be reviewed.

For family and clinic use and for routine test.

Features:

- one-key measurement, easy to use
- records and stores up to 199 groups of measurements
- LED colour screen with big font easy to read
- automatic power off when there is no operation
- high pressure prompt
- low battery and error indication
- switchable: mmHg and kPa

Supplied with adult cuff and 4 alkaline batteries AA.

Multilingual manual in: GB, FR, IT, ES, PT, DE, PL, RO, GR, SE, HR, Arabic

- 49881 CUFF - adult - 22-32 cm - spare
- 80555 CUFF - adult X-large - 32-43 cm - optional
- 80556 POWER ADAPTOR 100-240V, 50/60 Hz - optional



Size: 128x100xh 72 mm  
Weight: 281 g



49880

#### TECHNICAL SPECIFICATIONS

Measurement method:	Oscillometry
Measurement range:	0 kPa (0 mmHg) - 39.6 kPa(297 mmHg)
Resolution:	0.133 kPa(1 mmHg) ±0.4 kPa(±3 mmHg)
PR measurement range:	40 bpm - 240 bpm
Inflation:	automatic inflation by force pump
Deflation:	automatic multistep deflation
Display:	LED large colour screen
Power:	Four "AA" batteries or optional 5V power adapter
Safety:	Class II Type BF

## SMART AUTOMATIC DIGITAL B.P. MONITOR - ESH VALIDATION



European Society Hypertension



32921

Display 62x43 mm LCD

### • 32921 SMART AUTOMATIC B.P. MONITOR with adult cuff

Compact, fully logic, multiuser, B.P.M. with innovative features:

- smart inflation technology for automatic pumping to proper pressure
- WHO blood pressure indicator
- IHB Irregular Heartbeat Detection
- average value of latest 3 readings
- 2x60 memories, date and time
- displays systolic, diastolic and pulse rate separately
- multilingual manual and box: GB, FR, IT, DE, ES, PT, PL, GR, Arabic
- 32922 CUFF - adult - 22-30 cm (8-11") - black - spare
- 32923 CUFF - adult large - 30-42 cm (11-16") - grey
- 32920 CUFF - adult extra large - 42-48 cm (16-18.2") - grey

#### TECHNICAL SPECIFICATIONS

Measuring method:	oscillometric, automatic inflation and measurement
Measuring range:	cuff pressure: 0-300 mmHg ±3 mmHg
	pulse rate: 40-180 beats/min ±5% of reading
	systolic: 60-260 mmHg
	diastolic: 40-199 mmHg
Power supply:	4x "AA" batteries 1.5 V
Dimensions - Weight:	138x98x48 mm - 211 g (excluding batteries)
Arm cuff:	for arm circumferences 22-30 cm, 30-42 cm or 42-48 cm

## SMART AUTOMATIC DIGITAL WRIST B.P. MONITOR



European Society Hypertension



32918

Display 31.9x39.6 mm LCD

Multilingual manual and box: GB, FR, IT, DE, ES, PT, PL, GR, Arabic

### • 32918 SMART AUTOMATIC WRIST B.P. MONITOR

Compact, fully logic, B.P.M. with innovative features:

- smart inflation technology for automatic pumping to proper pressure
- WHO blood pressure indicator
- IHB Irregular Heartbeat Detection
- average value of latest 3 readings
- 2x60 memories, date and time
- displays systolic, diastolic and pulse rate separately

#### TECHNICAL SPECIFICATIONS

Measuring method:	oscillometric, automatic air inflation and measurement
Cuff pressure:	0-295 mmHg ±3 mmHg
Pulse rate range:	40-180 beats/min ±5% of reading
Range of measurement:	30-280 mmHg
Power supply:	2x "AAA" batteries 1.5 V
Dimensions - Weight:	84x64x28 mm - 110 g (excluding batteries)
Wrist cuff:	applicable for wrist circumferences 14-19.5 cm

## ANDON VALUE DIGITAL B.P. MONITOR

- 32901 ANDON B.P. MONITOR
- 32922 CUFF - adult - 22-30 cm - spare
- 32923 CUFF - adult large - 30-42 cm
- 32920 CUFF - adult extra large - 42-48 cm



TECHNICAL SPECIFICATIONS	
Measurement system	Oscillometric method
Measurement range	Pressure: 0-300 mmHg ±3 mmHg Pulse: 40-180 pulse/min ±5%
Power Source	4x1.5 V AAA batteries - not included
Dimensions - weight	107x80xh 52 mm - 170 g (ex. batteries)
LCD size	66x58.5 mm

- large easy to read LCD display, WHO blood pressure indicator
  - 4 groups x 30 times with time and date stamp
  - average of all saved measured blood pressure values for the last 7 days
  - arrhythmia detection (HB)
  - automatic switch-off.
- Multilingual box and manual:  
GB, FR, IT, ES, PT, DE



32901

Cuff circumference: 22-30 cm

# X-LIFE AUTOMATIC DIGITAL B.P. MONITORS - ESH VALIDATED

Size: 140x104x50 mm  
Weight: 247 g

LCD size 60x51 mm

Cuff size for arm  
circumferences  
23-33 cm



32924

Supplied with  
carrying bag



- 32924 X-LIFE B.P. MONITOR - arm
- 32926 X-LIFE B.P. MONITOR - wrist

Accurate and precise automatic digital blood pressure meters for smooth and fast measurements with innovative functions:

- IHB: irregular heartbeat detector
- WHO risk category indicator (classifies your measurements in 6 stages of risk, from optimal to severe hypertension)
- proven clinically to meet European Society of Hypertension ESH protocol
- easy to read, wide angle display
- 120 memories for 3 users: 3 zones of 40 memories each
- start/stop unique button, with blue backlight

Size: 74.5x74x30 mm  
Weight: 95 g

LCD size 34.5x42 mm

Cuff size for wrist  
circumferences  
13.5-19.5 cm



32926



European Society  
Hypertension



Liquid crystal  
display

- multilingual manual and box: GB, FR, IT, ES
- memory average: automatically average last 3 memories
- 32925 SPARE CUFF for 32924 - adult
- 32927 AC ADAPTOR for 32924

### TECHNICAL SPECIFICATIONS

Measuring method:	oscillometric	
Measuring range:	pressure:	0-300 mmHg
	pulse:	40-199 bpm
Accuracy:	pressure:	±3 mmHg
	pulse:	±5%
Power supply:	arm type:	4xAAA alkaline batteries
	wrist type:	2xAAA alkaline batteries
Battery life:	arm type:	300 measures
	wrist type:	250 measures

# JOLLY DIGITAL B.P. MONITOR



European Society  
Hypertension



32777

- 32777 JOLLY DIGITAL BLOOD PRESSURE MONITOR

Professional Blood Pressure monitor for medical use.

- large easy-to-read illuminated LCD display 86x74 mm
- WHO classification
- arrhythmia detection (IHB)
- 4-person memory zone - 30 memory space each
- average of all saved measured values and morning and evening blood pressure of the last 7 days
- time and date
- automatic switch-off

Multilingual manual and box:  
GB, FR, IT, ES, PT, DE, PL, GR.

- 32922 CUFF - adult - 22-30 cm (8-11") - black - spare
- 32923 CUFF - adult large - 30-42 cm (11-16") - grey
- 32920 CUFF - adult extra large - 42-48 cm (16-18.2") - grey



### TECHNICAL SPECIFICATIONS

Measurement system:	Oscillometric method	
Measurement range:	Pressure:	0~300 mmHg ±3 mmHg
	Pulse:	40~180 pulse/min. ±5%
Power source:	4x1.5 AAA batteries included	
Outside dimension:	150x95xh 65 mm	
Weight:	approx 235 g (without batteries)	

# DOMINO DIGITAL B.P. MONITOR

Automatic inflation  
deflation



32803



- 32803 DOMINO DIGITAL BLOOD PRESSURE MONITOR
  - 32804 DOMINO DIGITAL B.P.M. on trolley with basket
- Professional Blood Pressure monitor for hospital and medical use.

- extra large LCD display with innovative design
- date/time/ambient temperature (°C/°F) display
- IHB Irregular heartbeat detector
- WHO blood pressure classification indicator
- 120 memories (60 sets for 2 users)
- alarm clock reminding function

Multilingual manual and box:  
GB, FR, IT, ES, PT, DE, GR, Arabic

- 32802 AC ADAPTOR 230 V - 50 Hz
- 32809 ADULT CUFF - spare
- 32865 COILED TUBING EXTENSION 3 m (42/45 spirals)



### TECHNICAL SPECIFICATIONS

Measuring range:	Pressure -	40~260 mmHg
	Pulse -	40~160 beats/min.
Accuracy:	Pressure ±	3 mmHg
Power supply:	4x "AA" batteries or AC adaptor (option)	
	External dimension:	158x120xh 127 mm
Weight:	490 g	

32804



## ERKA VARIO: DESK, WALL AND TROLLEY

- 32671 VARIO - desk - adult cuff - 285.20.481
  - 32672 VARIO - wall - adult cuff - 288.20.481+295.00.003
  - 32673 VARIO - trolley Ø 50 cm - adult cuff - 288.20.481+995.00.003
- Superior quality product, for use in consulting rooms or hospital. The Vario model consists of a high precision manometer in a high quality ABS housing with an integrated fastening spigot for individual variable swivelling, a big cuff basket in white powder coated sheet steel, a bulb holder and spiral tubing with bulb and air release valve. This high quality chromium-plated valve makes sensitive adjustments easy. The 150 mm scale is equipped with a mirrored exterior ring and non-reflective manometer glass.
- 32898 PEDIATRIC "SUPERB" CUFF 2 TUBES - 20.5-28 cm\*
  - 32899 ADULT "SUPERB" CUFF 2 TUBES - 27-35 cm\* - spare
  - 32900 LARGE "SUPERB" CUFF 2 TUBES - 34-43 cm\*

\*Arm circumference

TECHNICAL SPECIFICATIONS		32671
Height with basket:	260 mm (32672-3)	
Width with basket:	180 mm (32672-3)	
Depth with basket:	120 mm (32672-3)	
Graduation:	0-300 mmHg ±3 mmHg	
Weight with basket:	1,350 g	
Height of trolley:	830-1,360 mm (adjustable)	
Tubing system Ø:	18-25 mm	
Swivel range:	up to 60 deg°	



## RIESTER BIG BEN®

- 32742 RIESTER BIG BEN® - rail (clamp code 32766 and rail not included) **MADE IN GERMANY**
  - 32743 RIESTER BIG BEN® - wall
  - 32746 RIESTER BIG BEN® - trolley Ø 54 cm - velcro adult cuff
  - 32740 RIESTER BIG BEN® - trolley Ø 54 cm - adult one piece cuff
  - 32748 RIESTER BIG BEN® - desk
- Aneroid sphygmomanometer, made of resistant plastic, with large dial (147 mm) and white pointer on black dial plate for easy-to-read measurements from 0 mmHg to 300 mmHg. Basket on back for cuff storage after use. Velcro-closure black cuff 2 tubes and long coil tubing. Latex free.
- 32766 RAIL CLAMP
- Universal clamp (for code 32742) for any rail.



## DAYTON DESK/WALL SPHYGMO

- 32745 DAYTON SPHYGMO - desk/wall model
- Provided with big dial (Ø 113 mm) for easy reading. Basket with handle easy to move and carry. Nylon cuff with D ring. Wall fixing. Size: 130x130x135 mm - Weight: 180g Measuring range: 0-300 mmHg ± 3 mmHg.
- 32850 ADULT CUFF - black - spare
- Available also 32839, 32841, 32843, 32847, 32849 see page 305



Large basket with handle for cuff

CE 0123

PVC bladder and bulb

LATEX FREE





## DALLAS SPHYGMO: WALL AND TROLLEY



• **32749 DALLAS SPHYGMOMANOMETER - wall model**  
 Provided with rear plastic basket for cuff storage.

• **32747 DALLAS SPHYGMOMANOMETER - trolley model**  
 Provided with rear plastic basket and stainless steel trolley adjustable in height, with 5 plastic castors Ø 5 cm. All DALLAS sphygmometers are provided with extra large dial plate (Ø 150 mm) for easy reading, black nylon calibrated cuff and latex quality inflation system and bladder. Scale 0-300 mmHg. Multilingual manual: GB, FR, IT, ES, PT, DE, GR. Multilingual box (32749 only): GB, FR, IT, ES, PT, DE, GR, Arabic.

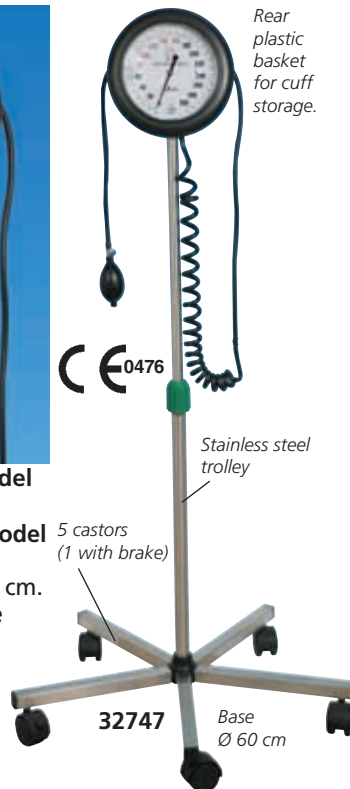

## DENVER SPHYGMO

### • 32744 DENVER SPHYGMOMANOMETER - trolley - adult cuff

Trolley sphygmomanometer, light but with high stability and 360° swivelling castors. Adjustable height (90 to 135 cm) with metal basket. Square-shaped-dial 145x145 mm. Nylon cuff, 2-tube adult TPU bladder, PVC bulb, dual use air-release valve with spring, spiral PVC tube (1.8 m). Multilingual manual: GB, FR, IT, ES, PT, DE, GR.

### CALIBRATED NYLON CUFFS

- 32839 CHILD CUFF - black
  - 32850 ADULT CUFF - black - spare
  - 32841 ADULT LARGE CUFF - black
- All cuffs with 2 tubes TPU bladder.



## LCD DISPLAY, MERCURY-FREE SPHYGMOMANOMETERS

### MERCURY FREE SPHYGMOMANOMETERS

A new technology of LCD display mercury-free sphygmomanometers alternative to the mercury column.

Precise results and support to global environment saving pollution. Manual inflation and air release. Two measuring methods: button AUSC (Auscultation), for use with a stethoscope, button OSCI (Oscillometric), to get the result automatically, without need of a stethoscope, just inflate the cuff not less than 180 mmHg. Suitable for pediatric use with auscultation method only (need 32825).

Supplied with adult cuff. Multilingual box and manual: GB, FR, IT, ES, PT, DE, GR, Arabic.

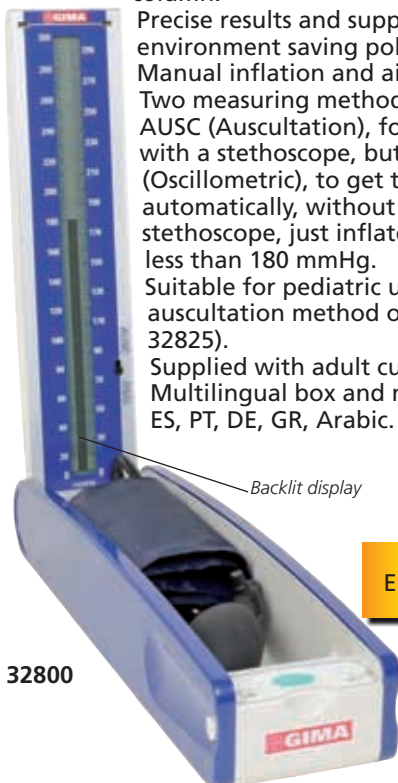

32800



32801

**GREEN AND ENVIRONMENTAL PROTECTION**

### AND PROFESSIONAL MERCURY FREE SPHYGMOMANOMETERS

Professional highly advanced digital blood pressure monitor alternative to the mercury column

- auscultatory blood pressure measurement
- digital readout for pulse rate
- cuff holder and grip for carrying
- durable and chemical resistant body
- full ABS housing lightweight body
- adjustable display column for easier analysis of results
- anti-glare display minimizes reflected light



32775



32776



- 32800 GREEN MERCURY FREE SPHYGMO - desk
- 32801 GREEN MERCURY FREE SPHYGMO - on trolley with basket
- 32825 PEDIATRIC CUFF 16-22 cm - optional
- 32827 ADULT CUFF 22-32 cm - spare
- 32828 LARGE ADULT CUFF 32-45 cm - optional

- 32775 UM-102A MERCURY FREE SPHYGMOMANOMETER - desk
- 32776 UM-102B MERCURY FREE SPHYGMOMANOMETER - trolley

### TECHNICAL SPECIFICATIONS

Size: 360x96x66 mm (32800) Power supply: battery  
 Measuring range: 20-280 mmHg Accuracy: pressure: ±3 mmHg

Size: 360x96x66 mm (32775)  
 Measuring range - pressure: 0-300 mmHg ±3 mmHg  
 - pulse: 40-180 beats/minute ±5% (32775-6)  
 Power supply: 2x1.5V AA alkaline batteries

## YTON ANEROID SPHYGMOMANOMETERS

### YTON ANEROID SPHYGMOMANOMETERS

Economic sphygmomanometers with nylon cuff with velcro closure, reliable manometer with clip to be fixed on the cuff. Scale 0-300 mmHg. Air release at closed tap max 4 mmHg/minute. Manual setting of deflation possible up to 2/3 mmHg/sec. From 260 mmHg to 15 mmHg max deflation time 10 sec. Scale graduated every 2 mmHg. Floating zero (the pointer has no stop point but swings freely), nylon velcro cuff, latex bulb with chromium plated valve. Chromium-plated air tap with air release regulation by screw valve. Supplied with a simulated-leather soft pouch with zip in a carton box. Available in 5 versions: standard, with one piece cuff, latex free, with incorporated stethoscopes or kit (sphygmomanometer+stethoscope). Multilingual box and manual: GB, FR, IT, ES, PT, DE, GR, Arabic.

GIMA code	YTON SPHYGMOMANOMETERS	
32720	YTON - black cuff	■
32692	YTON - one piece cuff	■
32704	YTON latex-free - blue cuff	■
32703	YTON - with incorporated - stethoscope - black cuff	■
32693	YTON KIT - sphygmomanometer + stethoscope	■
32701	YTON MANOMETER - spare	



**32703**  
Yton with incorporated Stethoscope



**32720**  
Yton sphygmomanometer



CE 0123

32692

ONE PIECE CUFF

LATEX FREE



CE 0123

32704

LATEX FREE



CE 0476

32703

INCORPORATED STETHOSCOPE



CE 0476

32693

LATEX FREE

KIT STETHOSCOPE + SPHYGMO

## KOBE PALM SPHYGMOMANOMETER

### 32690 KOBE PALM SPHYGMOMANOMETER

Economic, lightweight, palm type sphygmomanometer with reliable large dial manometer for easy reading. Scale 0-300 mmHg, graduated every 2 mmHg. Adult nylon cuff, PVC bladder, PVC inflation bulb with handle, release valve nicked in black. Supplied in vinyl carrying case with 10 languages user manual and box (GB, FR, IT, ES, PT, DE, GR, RO, HU, Arabic).

- 32845 ADULT CUFF - spare
- 32846 PEDIATRIC CUFF - optional

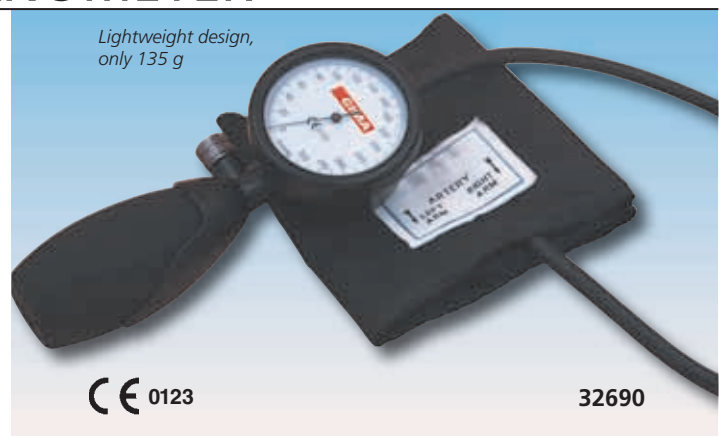

Lightweight design, only 135 g

CE 0123

32690

## SPHYGMOMANOMETERS WITH GAUGE ON THE CUFF

CE 0051

32724

CE 0051

CE 0476



- **32724 BERLIN SPHYGMO - velcro cuff**  
High quality sphygmomanometer with gauge mounted on cuff:  
- high reliable manometer with extra large dial Ø 65 mm  
- top quality and resistant linen cuff with simulated leather support and velcro closure  
- extra large PVC bulb, 9x5 cm, latex free German manometer

- **32723 NEW EXACTOPHON SPHYGMO - pull-on strap cuff**  
GIMA quality and reliability in a stylish and long-life sphygmomanometer. EXACTOPHON has a reliable manometer fixed on a simulated leather support, on a highly resistant linen pull-on straps cuff. Supplied in a nice carrying case and box.
- **32805 EXACTOPHON BLADDER - spare**

- **32719 GIMATONO - latex free**  
Economic sphygmo with chrome-plated manometer fixed on the cuff, provided with a rubber protective ring. Nylon cuff with simulated-leather support. Two tubes adult size latex free TPU bladder, with standard latex free PVC bulb. Supplied in nylon bag and cardboard box.

## SHOCK RESISTANT SPHYGMO MINOR 2 SPHYGMO - 2 TUBES

CE 0123

ISO 81060 STANDARD

3 YEARS WARRANTY



- **32702 SHOCK RESISTANT SPHYGMO - nylon-cuff**  
High quality, shock resistant sphygmomanometer matching the ISO 81060 standard.

**One piece design with damped system manometer**  
Creative design with a new structure that fixes all parts together closely to make it more steadier. The damped system absorbs impacts.

**Other features**

- large dial Ø 55 mm easy to read
- high precision air-release valve, provides precise rate adjustment and quick deflation
- adult nylon cuff with latex-free bladder
- soft bulb for fast inflation.

Multilingual box and manual: GB, FR, IT, ES, PT, DE.



- **32714 MINOR 2 SPHYGMO - 2 tubes - black nylon velcro cuff**
- **32713 MINOR 2 SPHYGMO - 2 tubes - green cotton hook cuff**  
High quality sphygmomanometer with traditional design and modern features.  
- high precision manometer, adjustable by turning a screwdriver, for perfect calibration any time  
- 2 tubes system for quick inflation  
- Available with washable coated fabric velcro cuff or cotton hook cuff



## SIRIO SPHYGMO AND 3 MULTICUFF KIT WITH BAG

CE 0476



32729

• **32729 SIRIO SPHYGMO - adult**  
 Classic sphygmomanometer with fabric cuff with velcro closure (green/grey colour). Reliable large dial manometer (60 mm) for easy readings, fixed on bulb. Scale 0-300 mmHg, graduated every 2 mmHg. Supplied in carrying case and box, with multilingual user manual: GB, FR, IT, ES.



• **32705 SIRIO PEDIATRIC KIT - sphygmo with 3 pediatric cuffs**  
 Sirio with 3 pediatric cuffs: minicuff (32812) 4 months - 3 years, minicuff (32813) 3-7 years, minicuff (32814) 7-10 years in a nylon bag.  
 • **27177 SIRIO MULTICUFF PEDIATRIC BAG - empty**



32705

• **32706 SIRIO KIT 3 - sphygmo with 3 one piece cuffs**  
 Sirio with 3 one piece cuffs: child (32910), adult (32911) and adult large (32912) in a nylon bag.  
 • **27178 SIRIO MULTICUFF BAG 3 - empty**



32706

• **32707 SIRIO KIT 5 - sphygmo with 5 cuffs**  
 Sirio with 5 cuffs: infant cuff (32886), child cuff (32888), adult cuff (32830), adult large cuff (32834) thigh cuff (32837) in a nylon bag.  
 • **27179 SIRIO MULTICUFF BAG 5 - empty**



32707

## LONDON: PROFESSIONAL SPHYGMO

CE 0476



32725

• **32725 LONDON SPHYGMO - adult - black cuff**   
 • **32726 LONDON SPHYGMO - adult - red cuff**   
 Professional, stylish, reliable, lightweight and latex free sphygmomanometer with ABS manometer, integral PVC bulb, high quality precision mechanism, velcro closure calibrated nylon cuff and one tube TPU bladder. Dial Ø 55 mm, with specially designed eye-catching colour printing and easy to read. Special outer ring protects the manometer from shocks and the glass from scratches. Supplied in a nice colour co-

CE 0476

Calibrated nylon cuff



32726

ordinated carrying bag with multilingual box and user manual: GB, FR, IT, ES, DE, PT, GR.



32726



## TOKYO AUTOMATIC

- **32736 TOKYO 2 SPHYGMO - adult - black cuff**  
Professional sphygmomanometer with large Ø 65 mm dial and **button type air release valve**. ABS light plastic case and extra shock-proof ring for long durability. 360° rotary handle (only 32735)  
Supplied with black nylon calibrated cuff (54x14.5 cm) with D-ring, black 1-tube PVC, latex free bladder and black, latex free PVC bulb in a nylon carrying bag and cardboard box.  
Multilingual box and manual: GB, FR, IT, ES, DE, PT, GR, Arabic.



## ROMA SPHYGMOMANOMETERS - 4 DIFFERENT MODELS

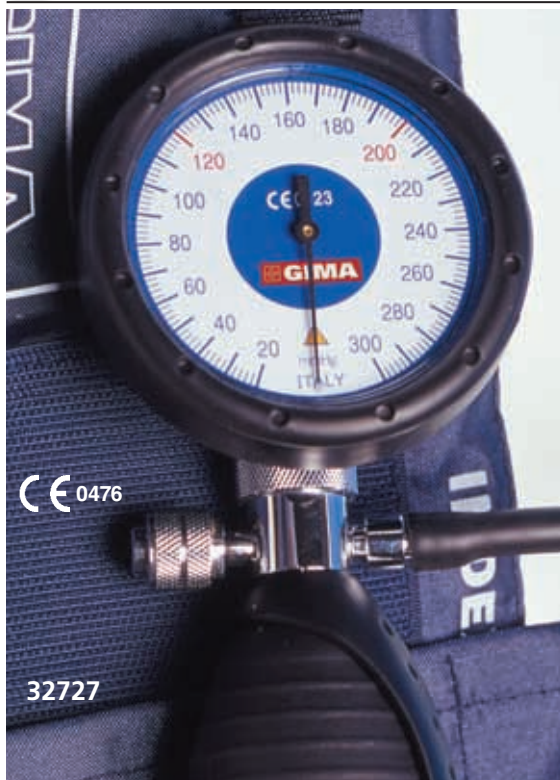

Classic, lightweight, reliable palm model aneroid sphygmo with certified manometer ABS housing, integral PVC bulb and air release valve for one-hand use, provided with handle, blue nylon, velcro closure, calibrated cuff and 1 tube TPU bladder. Large dial Ø 60 mm, with rubber protective ring. Supplied in a nice nylon carrying bag with external velcro pocket and cardboard box. Latex free.

- **32727 ROMA SPHYGMO - adult - 1 tube**
- **32734 ROMA SPHYGMO - adult - 2 tubes**
- **32709 ROMA SPHYGMO - pediatry - 1 tube**  
Same as 32727 but with pediatric cuff 35x11 cm
- **32856 PVC RIBBED BULB**
- **32857 PVC PROTECTIVE RING**



## ROMA MULTICUFFS KIT



- **32738 ROMA KIT - Sphygmo with 3 cuffs**  
Same as code 32727 but supplied with 3 cuffs: one pediatric (35x11 cm), one adult (53x14.5 cm) and one adult large (62x17.5 cm).  
Latex free.

## EMERGENCY MULTICUFF KIT

- **32771 EMERGENCY SPHYGMO KIT - 5 cuffs**  
Palm type sphygmomanometer with orange silicone shockproof ring and orange cup of air-release valve. PVC tube and 1 tube TPU bladder. Supplied in a plastic carrying case with 5 cuffs: XS infant (13-19 cm), S child (18.4-26.7 cm), M adult (25.4-40.6 cm), L adult large (33.3-51 cm), XL thigh (40.6-66 cm). Multilingual manual and box: GB, FR, IT, ES.



# NEWBORN TO OBESE CUFFS FOR ANEROID AND MERCURIAL SPHYGMO



Nylon cuff with velcro fastening, EPDM syntetic rubber bladder, latex free

MINI CUFFS grey/green - nylon					
1 tube	2 tubes	Model		Size cm	
32810	32820	Premature		16xh 5	
32811	32821	Up to 3 months		23xh 5	
32812	32822	4 months to 3 years		29xh 7	
32813	32823	3-7 years		33xh 9	
32814	32824	7-10 years		40xh 11	
32816	32826	32810-14, 32820-24		Set 5 pieces	



Calibrated nylon cuffs with TPU bladder and PVC tube

CALIBRATED CUFFS - latex free - nylon					
1 tube	2 tubes	Colour	Model	Size cm	Arm circumference
-	32839	Black	Pediatric	35x11	19 to 26 cm
32846	32847	Blue	Pediatric	35x11	19 to 26 cm
32842	32843	Blue	Adult	49x15	26 to 40 cm
32844	-	Red	Adult	49x15	26 to 40 cm
32845	32850	Black	Adult	49x15	26 to 40 cm
32848	32849	Blue	Adult large	62x17.5	34 to 51 cm
-	32841	Black	Adult large	62x17.5	34 to 51 cm



CUFFS grey/black - nylon - TPU bladder - velcro fastening					
1 tube	2 tubes	Model	Arm circumference	Size cm	
32886	32887	Infant	13 to 19 cm	7.5x26	
32888	32889	Child	18.4 to 26 cm	11x34	
32830	32832	Adult	25 to 40 cm	52x15	
32834	32835	Adult large	35 to 50 cm	61x17.5	
32837	32838	Thigh	41 to 66 cm	82x21	

ADULT CUFFS grey/green - cotton - TPU bladder - velcro fastening					
1 tube	2 tubes	Model	Arm circumference	Size cm	
32829	-	Adult		53x14.5	

One tube cuff for Ranger, Sirio, London, Boston, Roma 1T, Tokyo, Ri-san, Precisa, Minimus.  
Two tubes cuff for Minor, Diplomat, Yton line, Roma 2T, Dallas, Big Ben, Empire, Dayton.



Bladderless nylon cuffs  
- reusable above 10,000 times  
- disinfestable with alcohol/ethanol  
- soft surface for a pleasurable feeling on the skin  
- washable up to 60°C  
- ideal to prevent cross-contaminations  
- tested according to ISO 105 E01

BLADDERLESS ONE PIECE CUFF - latex free					
1 tube	2 tubes	Model	Size	Arm circumference	
32910	32913	Children	10x34 cm	19 to 27 cm	
32911	32914	Adult	14.5x54 cm	26 to 41 cm	
32912	32915	Adult large	16x63 cm	34.3 to 51 cm	
32819	32890	Thigh	20x83 cm	40.6 to 66.5 cm	

# SPHYGMOMANOMETERS SPARE PARTS AND ACCESSORIES



GIMA code	SPHYGMOMANOMETERS SPARE PARTS	Minimum order
32865	Coiled tubing - black (42-46 spirals) - 39.5 cm	1
32808	Nylon velcro cuff (no bladder) 54 x15 cm*	1
32874	1 tube Bladder	1
32875	2 tubes Bladder	1
32870	Male-Female metal connector	box 10
32871	Screw Type metal connector	box 10
32872	Bayonet Type metal connector	box 10
32873	Plastic connector	box 100

\*Can be used with 32874 or 32875

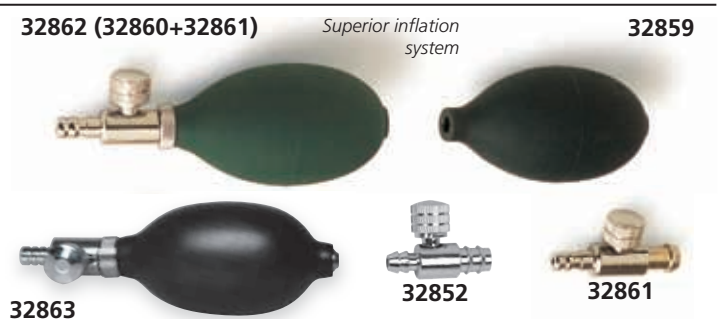

GIMA code	SPHYGMOMANOMETERS SPARE PARTS	Minimum order
32854	Yota PVC bulb - black - latex free	1
32851	Yota PVC bulb - green	1
32855	Yota latex bulb - black	1
32860	Superior PVC bulb - green - latex free*	1
32859	Superior PVC bulb - black*	1
32852	Yota chrome-plated air release valve	1
32861	Superior chrome plated air valve	1
32853	Yota inflation system	1
32862	Superior inflation system - latex free*	1
32863	Deluxe inflation system	1

\*Made in Germany

## RIESTER ORIGINAL CUFFS - LATEX FREE

### RIESTER VELCRO CUFFS WITH BLADDER 1 OR 2 TUBES

Child, adult, thigh cuffs made of high quality materials.

GIMA code	RIESTER code	RIESTER CUFFS 1 TUBE	Colour	Size cm	Circum. cm	Compatibility
49811	129	Child velcro cuff	light blue	34.5x10	15 - 22	All Riester single tube manual aneroid sphygmomanometers*
49812	107	Adult velcro cuff	black	54.5x14.5	24 - 32	
49813	122	Adult large velcro cuff	black	70x15	32 - 42	
49814	125	Thigh velcro cuff	black	70x22	42 - 50	
RIESTER CUFFS 2 TUBES						
49821	130	Child velcro cuff	light blue	35.5x10	15 - 22	All Riester twin tube sphygmomanometers including BigBen
49822	108	Adult velcro cuff	black	54.5x14.5	24 - 32	
49823	123	Adult large velcro cuff	black	70x15	32 - 42	
49824	126	Thigh velcro cuff	black	70x22	42 - 50	

\*Metal valve (included in Minimus II, E-Mega, Babyphon cuff) not included with spare cuff, can use valve from old cuff

### RIESTER ONE PIECE CUFFS 1 OR 2 TUBES

Ideal to prevent cross contaminations. Soft surface for more comfort. Latex free. Washable at 60°C and disinfectable in liquid, reusable up to 10,000 times. ISO 105 E01 tested.

GIMA code	RIESTER code	ONE PIECE RIESTER CUFFS 1 TUBE - length 50 cm	Colour	Size cm	Circum. cm	Compatibility
49816	154	Child one-piece cuff	dark green	35.5x10	15 - 22	Same as cuffs 1 tube
49817	150	Adult one-piece cuff	dark green	54.5x14.5	24 - 32	
49818	152	Adult large one-piece cuff	dark green	63x16	32 - 42	
ONE PIECE RIESTER CUFFS 2 TUBES - length 50 cm						
49827	151	Adult one-piece cuff	dark green	54.5x14.5	24 - 32	Same as cuffs 2 tubes
49828	153	Adult large one-piece cuff	dark green	63x16	32 - 42	



## HEINE ORIGINAL CUFFS - LATEX FREE

### HEINE ORIGINAL CUFFS 1 TUBE

High quality single tube cuffs with velcro fastener. Perfectly balanced for comfort and ease of use. Compatible with all Heine sphygmomanometers. Water resistant, washable material. Latex free.

GIMA code	HEINE code	HEINE CUFFS 1 TUBE	Colour	Size cm	Circum. cm	Compatibility
49801	M-000-09-702	Child - 2	grey	10x34	13-20	All Heine 1 tube
49802	M-000-09-704	Adult small - 3	grey	14x53	20-29	
49803	M-000-09-619	Adult - 4	grey	14x58	29-41	
49804	M-000-09-706	Adult large - 5	grey	17x70	35-47	



## ERKA ORIGINAL GREEN CUFFS SUPERB RAPID - LATEX FREE

### ERKA GREEN CUFFS SUPERB RAPID 1, 2 OR TWIN TUBES

Superb cuffs are easy to disinfect and clean, equipped with a waterproof surface. Cuffs are comfortable and consist of a cover and a removable inflation bladder. Super soft adhesive and fleece strap on the cuff. Made of durable patented German PU material. Optimal in blood pressure measurement because of pressure distribution and the highly precise values. PVC, DEHP and latex free. Available in different sizes with 1, 2 or twin tubes.

GIMA code	ERKA code	ERKA GREEN CUFFS SUPERB RAPID 1 TUBE	Colour	Size cm	Circum. cm	Compatibility
32895	025-28493	Infant	grey	21.5x6.6	10-15	Switch and Kobold
32896	025-27493	Baby	grey	30.3x9.1	14-21.5	
32891	025-26493	Child	grey	40x11.6	20.5-28	
32892	025-20493	Adult	grey	47x14.3	27-35	
32893	025-24493	Adult large	grey	56x17.5	34-43	
32894	025-29493	Thigh	grey	75x21.5	42-54	
ERKA GREEN CUFFS SUPERB RAPID 2 TUBES						
32898	025-26481	Child	green	40x11.6	20.5-28	Vario
32899	025-20481	Adult	green	47x14.3	27-35	
32900	025-24481	Adult large	green	56x17.5	34-43	
ERKA GREEN CUFFS SUPERB RAPID TWIN TUBE						
32877	025-26482	Child	green	40x11.6	20.5-28	Perfect Aneroid and Profi
32878	025-20482	Adult	green	47x14.3	27-35	
32879	025-24482	Adult large	green	56x17.5	34-43	



## PRESS<sup>SAN</sup> HYGIENIC PROTECTION OF SPHYGMOMANOMETER

### • 32858 PRESS<sup>SAN</sup> HYGIENIC PROTECTION OF SPHYGMO - box of 10

A practical hygienic accessory for the sphygmomanometer to protect patient's skin whilst measuring the blood pressure. Made of a white non-woven fabric.

Ensures patient's comfort and hygiene.

Can fit any kind of sphygmomanometer or pressure holter.



32858

## RIESTER SANAPHON®



MADE IN GERMANY

Sturdy and light aluminium casing, corrosion protected

32686

Spoon-shaped handle made of stainless-steel

- **32686 SANAPHON® SPHYGMO with integrated stethoscope**
- A classic palm-style sphygmomanometer for precise self-measurement including stethoscope. Sanaphon® guarantees exact measurement values even for patients with heart rhythm disturbances. Maximum error tolerance  $\pm 3$  mmHg. Supplied in zipper bag.

## RIESTER E-MEGA®



Riester

High-polished manometer surface, easy to disinfect

Large dial  $\varnothing$  63 mm

Supplied in zipper bag.

CE 0124

32687

Shock protecting polycarbonate case



MADE IN GERMANY

32751, 32752

- **32687 E-MEGA® SPHYGMO - white - adult**
  - **32751 E-MEGA® SPHYGMO - black - adult**
  - **32752 E-MEGA® SPHYGMO - black - paediatric**
- Disinfectable, washable and latex free one-piece cuff.
- fast inflation of the cuff due to ergonomic spoon design
  - lifelong precision due to almost non-aging precision movement, with specially tempered copper-beryllium diaphragm for pressure-loading capacity up to 600 mmHg
  - maximum error tolerance  $\pm 3$  mmHg
  - comfort - air release valve, wearfree, with fine adjustment

## RIESTER EXACTA®

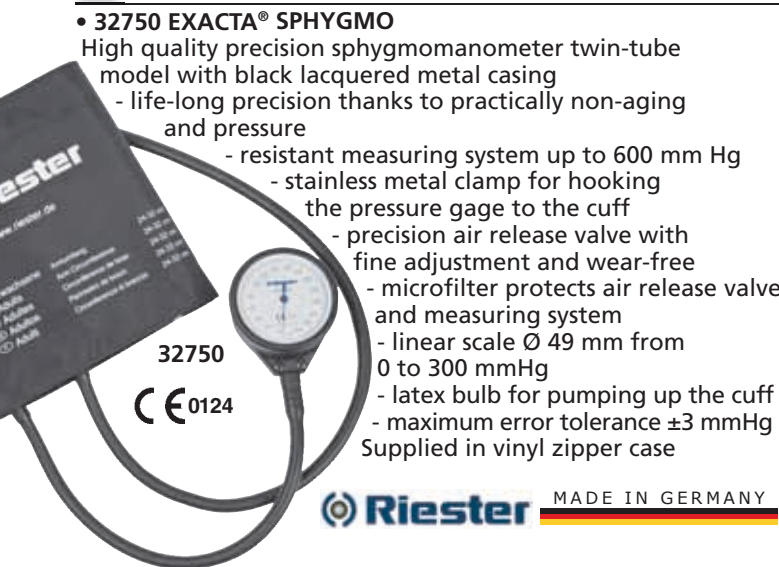

- **32750 EXACTA® SPHYGMO**

High quality precision sphygmomanometer twin-tube model with black lacquered metal casing

- life-long precision thanks to practically non-aging and pressure
- resistant measuring system up to 600 mm Hg
- stainless metal clamp for hooking the pressure gage to the cuff
- precision air release valve with fine adjustment and wear-free
- microfilter protects air release valve and measuring system
- linear scale  $\varnothing$  49 mm from 0 to 300 mmHg
- latex bulb for pumping up the cuff
- maximum error tolerance  $\pm 3$  mmHg

Supplied in vinyl zipper case

Riester MADE IN GERMANY

Riester MADE IN GERMANY

## RIESTER SPHYGMOTENSIOPHONE®



- **32760 SPHYGMOTENSIOPHONE - 1380**

Extreme precise two-tube sphygmomanometer with refined functionality. High quality cotton adult cuff finished in artificial leather is provided with a metal clip through which to pull the cuff. Supplied in zippered nylon bag.

- precision air release valve with fine adjustment and wear-free
- microfilter protects air release valve and measuring system
- tempered copper-beryllium diaphragm almost non-aging
- diaphragm pressure-loading capacity up to 600g mmHg
- maximum error tolerance of  $\pm 3$  mmHg
- easy to read scale  $\varnothing$  49 mm from 0 to 300 mmHg

32760

## BABYPHON® RIESTER PEDIATRIC SPHYGMO

- **32710 BABYPHON® PEDIATRIC SPHYGMO with 3 cuffs**
- Palm pediatric sphygmomanometer with 3 cuffs
- fast inflation of the cuff due to ergonomic spoon-shaped stainless steel handle
  - easy reading metal manometer with aluminium scale  $\varnothing$  49 mm (1.929 inch)
  - lifelong precision due to almost non-aging precision movement with specially tempered copper-beryllium diaphragm for pressure-loading capacity up to 600 mmHg
  - linear scale up to 300 mmHg,  $\pm 3$  mmHg
  - bear imprint on the cuffs
- Supplied with 3 pediatric cuffs (child, infant and new-born in a padded nylon zipper case).
- Newborn: size 15.5x5 cm - circumference 5-8 cm  
 Infant: size 23x7.5 cm - circumference 8-13 cm  
 Baby: size 35.5x10 cm - circumference 13-17 cm

Riester MADE IN GERMANY





# RIESTER PRECISA® N ANEROID SPHYGMOMANOMETERS



32755

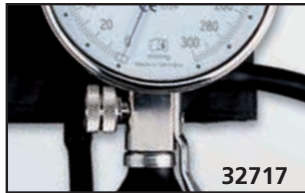

32717



32756



Easily readable scale Ø 64, from 0 to 300 mmHg, ±3 mmHg

Precision air release valve with fine adjustment and wear-free

Latex free

32755

32717

CE 0124

Riester



MADE IN GERMANY



Linear aluminium scale Ø 63 mm

32757

SHOCK PROOF

3 YEARS WARRANTY ON CALIBRATION

- 32755 PRECISA® N - plastic/metal - 1 tube
  - 32717 PRECISA® N - aluminium - 1 tube
  - 32756 PRECISA® N - aluminium - 2 tubes
- High quality, reliable sphygmomanometers with precision that lasts a lifetime.
- microfilter protects air release valve and measuring system
  - specially tempered copper-beryllium diaphragm, with precision movement and almost non-aging

- diaphragm pressure-loading capacity up to 600 mm Hg
- metal valve base
- ergonomic spoon-shaped grip made of stainless steel
- linear, tilted aluminum (32717, 32756) or plastic/metal (32755) scale, from 0 to 300 mm Hg (easily legible)
- Supplied with calibrated nylon cuff with velcro in synthetic leather bag.

- 32757 PRECISA® N SHOCK PROOF SPHYGMO
- Shock-resistant aneroid sphygmomanometer with same features as Precisa® N.
- Shock-resistant from a height of 1 m, according to DIN EN 81060-1:2012-08, to prevent impact or falls on the floor from compromising measurement accuracy.

# RIESTER RI-SAN®, MINIMUS® II AND R1 SHOCK PROOF® ANEROID SPHYGMO

Riester



Easily readable scale Ø 64, from 0 to 300 mmHg, ±3 mmHg

Precision air release valve with fine adjustment and wear-free

32715

CE 0124

Suitable for right or left handed users

- 32715 RI-SAN® SPHYGMO - light blue - latex free
- 32718 RI-SAN® SPHYGMO - green
- 32721 RI-SAN® SPHYGMO - slate grey

- High quality palm-style sphygmomanometer with ergonomic design.
- Air release valve conveniently regulated by finger-tip control.
- calibrated nylon cuff with velcro
  - latex-free bulb for pumping up the cuff
  - tube connection at the top of pressure gauge for unhindered blood pressure measurement
  - microfilter protects air release valve and measuring system
  - specially tempered copper-beryllium diaphragm almost non-aging
  - the precision movement guarantees reliable measurement
  - diaphragm can be pressurized up to 600 mmHg without decalibrating the sphygmo.
  - 32730 GREY BULB FOR RI-SAN - spare



32711



BHS VALIDATION

CE 0124

MADE IN GERMANY

- 32711 MINIMUS® II SPHYGMO
- Minimus® II is a reliable, durable and elegant palm model aneroid chrome-plated manometer with integral latex-free bulb and air release valve for one hand use, provided with a stainless steel handle, Luer Lock connection, calibrated black nylon velcro closure cuff and 1 tube bladder.
- Precision air release valve with fine adjustment and wear-free.
- Supplied in a nice synthetic leather bag.

CE 0124



Non-resistant opening of air release valve ensures precise and comfortable operation

5 YEARS WARRANTY ON CALIBRATION

SHOCK PROOF

32716

Fast, ergonomic inflation due to optimized bulb design with integrated spoon

Weight: 173 g

Riester

- 32716 R1 SHOCK PROOF SPHYGMO
- Exact precision that lasts a lifetime.
- shock-proof up to a falling height of 120 cm
  - scale: Ø 52 mm black with red fluorescent pointer
  - valve base and air duct with metal precision valve
  - two-component ABS casing
  - metal threaded tube connection at the top of the casing for fast cuff exchange and ergonomic operation
  - maximum error tolerance of ±3 mmHg
  - supplied in zipper bag
  - latex free

## KOBOLD SPHYGMOMANOMETER BY ERKA

- 32691 BLACK KOBOLD with gray cuff - 223.20493
  - 32695 GREY KOBOLD SET with 3 ped. "Superb" cuffs - 227.71.393
  - 32696 GREY KOBOLD SET with 6 "Superb" cuffs - 227.71.195
- Elegant and compact, single tube sphygmomanometer for frequent use in clinic and consulting room. Precision manometer, anodised aluminium Ø 48 mm. Sensitive adjustable air reduction valve, high quality chrome finish. Scale: 300 mmHg, 2 mm scale division. New technology with air intake via the manometer capsule in the specially tempered copper-beryllium membrane. Codes 32693, 32695, 32696 are latex free.

### ERKA "SUPERB" GREEN CUFFS

All ERKA Green cuff products are PVC, demp and latex-free, every one is individually tested prior to delivery and guaranteed for 50,000 inflation cycles. They are equipped with clearly marked size and positioning features for the most accurate possible measurements. The soft, easy to disinfect, biocompatible materials ensure maximum patient comfort. Conform to ANSI/AAMI SP10 standard

- 32891 PEDIATRIC "SUPERB" CUFF 1 TUBE 20.5 - 28 cm - grey
- 32892 ADULT "SUPERB" CUFF 1 TUBE 27-35 cm - grey - spare



32691

**ERKA.**

MADE IN GERMANY



32696 CE 0124

Includes 6 cuffs for below indicated circumferences of upper arm

Thigh 42-54 cm    Adult large 34-43 cm    Adult 27-35 cm    Child 20.5-28 cm    Baby 13-20 cm    Infant 10-15 cm



CE 0124

Child 20.5-28 cm    Baby 14-21.5 cm    Infant 10-15 cm

32695

## PERFECT ANEROID



Erka Superb Green cuff. Latex, PVC and DEHP free

32688

**ERKA.**

MADE IN GERMANY

- 32688 ERKA PERFECT - 201.204.82 dial Ø 48 mm - 2 tubes green
- Sphygmomanometer with screw valve for sensitive adjustments, velcro cuff and case.
- manometer housing brass chromed plated
  - membrane-protection 2-tube technology
  - measuring range 0-300 mmHg ±1%
  - 3 year warranty.
  - 32877 PEDIATRIC "SUPERB" CUFF TWIN TUBE 20.5 - 28 cm - grey
  - 32878 ADULT "SUPERB" CUFF TWIN TUBE 27-35 cm - grey - spare

## ERKA SWITCH



32698

**ERKA.**

MADE IN GERMANY

- 32698 ERKA SWITCH 2.0 CONFORT - dial Ø 56 mm - 1 tube grey - 293.204.93
- It offers outstanding ergonomics and simple adaptation for left and right-handle users. It is manufactured from shock-resistant polycarbonate and has passed the shock test according to AAMI SP9. The sight glass is chemically stable and unbreakable. The brass valve screw works smoothly and is adjustable to exact settings. MR compatibility. Measuring range 0-300 mmHg ±1%. Supplied with pouch. 4 year warranty hand held, 2 year manometer.
- 32891 PEDIATRIC "SUPERB" CUFF 1 TUBE 20.5 - 28 cm - grey
  - 32892 ADULT "SUPERB" CUFF 1 TUBE 27-35 cm - grey - spare

## ERKA SWITCH SIMPLEX



32697

**ERKA.**

MADE IN GERMANY

- 32697 ERKA SWITCH SIMPLEX - dial Ø 56 mm - twin tubes grey - 294.408.94
- It is manufactured from shock-resistant polycarbonate and has passed the shock test according to AAMI SP9. The sight glass is chemically stable and unbreakable. The brass valve screw works smoothly and is adjustable to exact settings. Measuring range 0-300 mmHg ±1%. Black velcro cuff. Supplied with pouch. Magnetic Resonance (MR) compatibility. 2 year warranty.

# BOSTON SPHYGMO G5® AND G7® HEINE SPHYGMO



• 32731 BOSTON SPHYGMO - adult - black cuff

Strong durable and elegant palm model aneroid metal zinc-alloy manometer with integral PVC bulb and air release valve for one hand use, provided with a special left and right hand adjustable handle, nylon velcro closure calibrated cuff and 1 tube TPU bladder. Easy to read: large dial Ø 60 mm. Unique push button air release valve offers precise mini-deflation. Special PVC patented ribber bulb. Latex free. Supplied with a nice nylon carrying bag. Multilingual box and manual: GB, FR, IT, ES, PT, DE, GR, Arab.



10 YEARS WARRANTY



MADE IN GERMANY

5 YEARS WARRANTY

The inflator spoon can be set for left and right-handed users.

- 32737 GAMMA "G5®" HEINE SPHYGMO - plastic manometer - M-000.09.230
  - 32741 GAMMA "G5®" HEINE SPHYGMO - plastic manometer
- Same as 32737, but supplied without carrying bag.
- 32739 GAMMA "G7®" HEINE SPHYGMO - aluminium manometer - M-000.09.232

With the new latex free G5® and G7® Heine, GIMA offers an aneroid sphygmomanometer of the highest quality of design and function with unequalled value for money. A modern, functional design combined with exceptional precision of measurement and durability make Heine G5® and G7® ideal for long-term use in clinic and practice environments.

- latex-free
  - exceptionally-strong housing construction with triple-mounted, **shockproof** movement.
  - **impact-resistant housing** crafted in special, shock-absorbing materials incorporate the latest advances in injection-moulding technology.
  - a **microfilter** protects the valve and movement.
  - **oversized inflator** speeds up cuff inflation.
- 5 years warranty (G5), 10 years warranty (G7).



G5® and G7® (excluding 32741) are supplied with high quality HEINE carrying bag.

# WELCH ALLYN® DURA SHOCK™ DS55 SPHYGMOMANOMETER

10 years calibration warranty



Laser engraved dial

Shock resistant body



- 32700 DURA SHOCK DS55 SILVER LINE - DS-5501-189
- Welch Allyn's DS55 sphygmomanometer incorporating shock-resistant DuraShock technology offers practical benefits compared to traditional aneroid sphygmomanometers. This is especially beneficial in busy medical environments where equipment needs to be as robust as possible. With DuraShock Technology, Welch Allyn B.P. gauges:
- remain in calibration longer than traditional aneroid B.P. gauges, providing you with more accurate readings.
  - do not need to be replaced as often as traditional aneroid B.P. gauges, giving you a lower lifetime cost.
  - have the only gauge capable of passing AAMI's shock-resistant specification of surviving a 76 cm drop onto a hard surface and remaining in calibration.



### How DuraShock technology works

In traditional aneroid sphygmomanometer design, several delicate gears and springs convert and amplify vertical movement of the pinion to rotational movement to turn the pointer. The DuraShock gear-free design uses a single helix spring to directly convert the vertical movement of the pinion to rotation of the pointer without the use of a multi-step gear arrangement. By creating a gear-free design, the Welch Allyn Durashock has fewer moving parts providing a gauge which is shock resistant and lighter than traditional gauges. Until now, a dropped sphygmomanometer required recalibration or replacement. The DuraShock can fall 76 cm onto a hard surface and still remain accurate. It is the only gauge capable of meeting the AAMI Shock Resistant specification.

## MT 10 - HANDHELD IMPEDANCE TYMPANOMETER

- 33665 MT10 - HANDHELD TYMPANOMETER
  - 33666 MT10 - HANDHELD TYMPANOMETER WITH IPSI-REFLEX
- Professional handheld tympanometer for setting fast and reliable testing in an easy and cost effective way.

### Objective analysis

Fast and easy to operate and provides objective measures that cannot be obtained by otoscopy alone.

### Easy and fast tympanograms

Results can be obtained with little efforts and with no response required from the patient. This is especially beneficial when dealing with difficult-to-test patients or small children.

### Clinical application

Suitable for diagnostic use as tympanometer and (33666 only) reflex responses are all recorded with great detail. You can detect otitis media (a major cause of temporary or permanent hearing impairment in children), a perforated eardrum, cholesteatomas and certain neurological disorders. You can also check tympanostomy tubes and follow up on post medical treatments.

### Ipsilateral Acoustic Reflex (33666 only)

Four different reflex tests at 500, 1,000, 2,000, 4,000 Hz may be performed per ear using either fixed or automatic intensity selection. Actual reflex characteristics are displayed on the screen.

### 30 patients in memory

Can hold test results of up to 30 patients, allowing to screen a large group of patients and print out the data at a later time.

**PC-integration** with optional infrared USB interface and software. Full data-transfer to PC



33669



### Interacoustics

Supplied with handle, set of 139 disposable ear-tips (mixed sizes) 4x1.5 V battery and manual in GB, DE, FR, IT, ES, SE, GR, PT, DK, FI, CZ, PL, LT, EE, HU, NL, NO, IS, RO, MK.  
Internal software: GB, FR, DE.

- -400 to +200 daPa
- ipsi-reflex (33666 only)
- 30 patient memory
- PC integration



Ergonomic to hold. Included handle make it stable and lightweight as it can rest on your arm during the measurement.

Size: 19x8x4 cm excluding probe (length with probe 22.5 cm)  
Weight 285 g without battery

- 33667 INTERFACE USB ADAPTER AND SOFTWARE BY IRDA PORT
- 33669 SANIBEL MPTII PORTABLE THERMAL PRINTER
- 33670 THERMAL PAPER ROLLS - box of 3

### TECHNICAL SPECIFICATIONS

<b>Tympanometry</b>	
Analysis performed:	Peak compliance; peak pressure, gradient; equivalent ear canal volume
Probe tone:	226 Hz
Pressure levels:	+200 daPa to -400 daPa
Ear volume measurement range:	0.2 ml to 5 ml
Sweep speed:	Typically 200-300 daPa/sec; depending on ear & cavity volume
Pressure limits (safety shut off):	+600 to -800 daPa
<b>Reflex measurements (33666 only)</b>	
Measurement mode:	ipsilateral
Reflex tone levels:	500 Hz, 1 kHz, 2 kHz, 4 kHz
Four reflex levels:	100 dB with 5 dB or 10 dB steps; 95 dB, 90 dB or 85 dB with 5 dB steps
Reflex analysis:	Reflex pass/refer at each level tested; Maximum amplitude of each reflex (seen on printed report and PC report); Pressure at which reflex was performed

<b>Data management</b>	
Data storage:	30 records. Any recording can be stored once the tympanogram is viewed
Data held:	Patient Initials, Tympanogram and Reflex graphs and analysis for Left and/or Right Ear, Time and Date of recording, which ears were tested, whether or not the record has been printed and sent to a PC, parameters printed and/or sent to a PC, parameters used for analysis
<b>Other data</b>	
Internal backup:	>30 days without main batteries fitted
Battery Lifetime:	Approx. 400 tests (Alkaline AA batteries)
Supported printer:	Martel MCP8830 or Sanibel MPTII
Interface:	Infra-red, IrDA hardware, 9600 baud
Information printed:	Space for patient and clinician's details, Tympanogram analysis parameters, Tympanogram, Reflex analysis parameters, Reflex graph, S. N. of device, Last and Next Due Calibration dates
Safety standards:	IEC 60601-1. EMC: IEC 60601-1-2
Impedance standard:	IEE 60645-5, Type 2 Tympanometer

## PA5 PEDIATRIC PORTABLE AUDIOMETER



- 33601 PA5 AUDIOMETER
- 33602 TDH39 AUDIOMETRIC HEAD PHONE

Paediatric portable audiometer with air conduction, free-field and visual stimulation capabilities. By means of a headphone it can be also used as a regular screening audiometer for adults. PA5 helps doctors in evaluating the auditory behaviour in neonates and infants till 24 months by means of specific tests:

### Auropalpebral Reflex (APR) test

APR test is a startle reflex of the eyelid elicited by relatively strong sounds that can be performed on neonates from the day of birth. It is not based on co-operation with the newborn child.

### Conditioned Orientation Response (COR) test

Based on the "Orientation Reflex", a natural reflex movement elicited by sound or visual stimulation. If the visual stimulation elicits a reflex which is conditioned by a tone, the child will look towards the visual stimulation as soon as the tone is heard. If the conditioning is effective the child will look in the direction of the sound source even before the visual stimulation is presented.

### Visual Reinforcement Audiometry (VRA) test

VRA test is an extension and modification of COR, where the

cooperation with the child is less important. Not only the sound localisation orientation reflex are accepted but also four other reactions: reflex reactions (body and face), search reactions, orientation reactions and spontaneous reactions.

### Reflex audiometry and maturation of auditory response tests

Different stimuli are presented in terms of intensity, frequency, duration, direction of sound in order to elicit proper reactions like waking-up, crying, astonishment, direct sound localization.



Supplied with GB manual and quick guide (GB, US, DE, FR, SE, IT, PT, DK, FI, ES, GR, CZ, PL, NL, NO, EE, HU, SL).

33601

### TECHNICAL SPECIFICATIONS

Frequencies:	500, 1,000, 2,000, 3,000, 4,000 Hz
Stimuli:	Warble tone, NB and WN
Intensities:	Distance 50 cm: 20/30-80dB HL in 10dB steps, for Warble Tone and WN 10/20-70dB for NB increases intensity by 10 dB
Dimensions - weight:	Distance 16 cm: LxWxH: 25x7x5 cm - 360 g
Power supply:	3AA batteries (included)

## BOEL STYLE PEDIATRIC AUDIOLOGY TEST



- 33599 GIMA AUDIOTEST - pediatric audiology test for early detection of childhood deafness

The Boel test is a unique screening tool that tests the hearing abilities and child's response to a sound stimulus, even at an early age (between 6 to 10 months). GIMA audiotest is based on the BOEL test both for the ergonomics (designed to be held in the palm of the hand not visible to the child) and the standard sound of the bells. The two sound stimuli emitted by the audiometer reproduce a dull

low-frequency tone located at about 125-150 Hz and an acute high-frequency tone located at about 5.0-5.1 kHz in exactly the same way as the bells of the Boel test (amplitude 86dBa; 96dBa). Testing the child's response to these highly significant thresholds. Easy to use, with only two buttons for the selection of two frequencies, lightweight and battery-powered.



Class I medical device according to 93/42/EEC. MADE IN ITALY

33599

# TIMPANI HANDHELD TYMPANOMETER/SCREENING AUDIOMETER

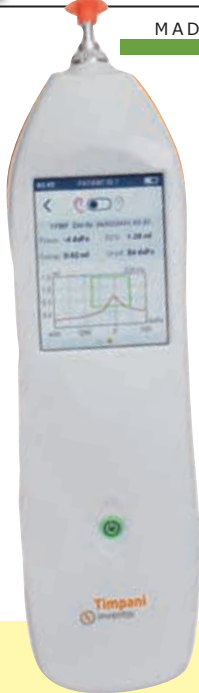

MADE IN ITALY



Timpani can be supplied with its docking station, ideal to place the device, to recharge the battery faster and to transfer data to the PC at the same time.

53560 + 53566



Timpani is supplied with Inventis Maestro software, USB connection cable, medical grade power supply, assorted eartips, GB, IT manuals in a carrying case.

53560

### TECHNICAL SPECIFICATIONS

- **53560 TIMPANI HANDHELD TYMPANOMETER**  
Timpani is a lightweight, compact and powerful device, designed to conduct middle ear screening tests simply, swiftly and accurately. The basic version of Timpani allows to perform automatic tympanometry exam using 226 Hz probe tone. Optional licenses allow acoustic reflexes test and screening pure tone audiometry. The device features a wide colour display with touch-screen interface.
- **53563 REFLEX LICENSE - PLUS**  
To conduct ipsilateral acoustic reflex test at 0.5, 1, 2 and 4 kHz.
- **53564 SCREENING PURE TONE AUDIOMETRY (PTA) LICENSE WITH PRE-CALIBRATED HEADSET**  
To conduct pure tone air conduction audiometry.
- **53565 PATIENT RESPONSE BUTTON FOR PTA**
- **53566 DOCKING STATION FOR TIMPANI**
- **53567 BLUETOOTH THERMAL PRINTER**
- **33250 THERMAL PAPER ROLL 57 mm - box of 5**

LANGUAGES	GB	FR	IT	RU	ES	PL	PT	JP	CH	KR	DE	TR
Firmware	X	X	X		X	X						
Maestro software	X	X	X	X	X	X	X	X	X	X	X	X
Manual*	X		X		X							

\*GB and IT included with product, ES for download from [www.gimaitaly.com](http://www.gimaitaly.com)

### Measurement system

Probe tone: 226 Hz at 85 dB SPL  
 Comp. range: 0.2 to 8.0 ml at 226 Hz, 0.9 to 16.0 mmho at 1000 Hz  
 Pressure range: from +200 to -400 daPa  
**Tympanometry**  
 Type of test: automatic tympanometry  
 Start: automatic  
 Scan rate: 400 daPa/sec  
**Acoustic reflex (only with 53563)**  
 Stimulation: ipsilateral at 226 Hz  
 Available tests: autothreshold, fixed intensity  
 Stimuli: 0.5, 1, 2 and 4 kHz (with reflex lic. Plus)  
 Maximum int.: 100 dB HL (ipsi)  
 Stim. Duration: 1 sec

### Audiometry (only with 53564)

Intensity - Freq. range: -10 to 100 dB HL - 125-8000 Hz  
 Input - output: pure tone - AC  
**Device specifications**  
 Memory: 50 patients  
 Display type: color graphical with touch screen  
 Display size: 2.8" / 43.2x57.6 mm  
 Resolution: 240x320 pixels  
 Power supply: Lithium-Ion rechargeable battery  
 Battery life: >4 hours of continuous use  
 PC interface: USB (driverless)  
 Software: Inventis Maestro (compatible with Noah)  
 Size - weight: 65 x 44 x 240 mm (2.6 x 1.8 x 9.5 inches) - 340 g / 12 oz  
 Standards: Imped.: EN 60645-5/ANSI S3.39, Type 2/3  
 PTA: EN 60645-1/ANSI S3.6, Type 4/4  
 Safety: EN 60601-1 - EMC: EN 60601-1-2 Class IIA (93/42/EEC)

# MAICO MA1 SUPER-LIGHTWEIGHT HEARING SCREENER

• **33600 MAICO MA1 HEARING SCREENER WITH HEADSET**  
 Hearing screener with super-lightweight design, small enough to fit in the palm of the hand. Ideal for fast screening purposes. The device is capable of delivering a pure tone signal to one ear at a time. The stimulus range is 15 to 50 dB HL in level steps of 5 dB. Test frequencies range from 500 to 4000 Hz. Automatic ON/OFF function. It is supplied with headset DD45, cradle and 2AA batteries. Multilingual manual: GB, FR, IT.



Test signal:	pure tone (continuous)	Hearing level range:	15dB HL to 50 dB HL	Power supply:	2AA batteries (included)
Test frequencies:	500, 1000, 2000, 4000 Hz	Accuracy - distortion:	± 4 dB - less than 3%	Standards:	IEC 60601-1:2012 Type B, IEC60601-1-2:2014
Level steps:	5 dB	Size - weight:	6.4x15.3xh 2.3 cm - 115 g	Classification:	Class IIa (EU 2017/745) Medical Device

# SINGLE USE TYMPANOMETER EARTIPS - FOR MOST BRANDS

SANIBEL™ ear tips were designed for use with acoustic immittance instruments and otoacoustic emission system. Made of a soft and sticky biocompatible material, these ear tips greatly improve the ease of obtaining and keeping a good seal, allowing the tester to quickly move on to other tasks. Available in different sizes, with different shapes (mushroom and flanged ear tips for infants). The complete range makes it possible to accommodate all ear canal shapes and sizes. All Sanibel™ ear tips are latex free.

**Sanibel™**



**VERIFIED COMPATIBILITY FOR SANIBEL™ ADI**

Amplivox®	Otowave™ with clear (Type 1) probe
Interacoustics®	AT235™ & AT235h™ with clear probe tip adapter AA222™ & AA220™ with clear probe tip adapter Eclipse™ and MT10™ with clear probe tip, Titan™
Maico®	MI24™, MI26™, MI34™, MI44™ with clear probe tip adapter easyTimp™ - Otowave™ - Ero-scan plus™ - easyScreen™
MEDRx®	Otowave™
Grason-Stadler®:	Corti™

GIMA code	SANIBEL™ ADI FLANGED INFANT EAR TIPS	Minimum order
53515	Ear tip 3-5 mm - red	bag of 100 pcs
53516	Ear tip 4-7 mm - blue	bag of 100 pcs
53517	Ear tip 5-8 mm - yellow	bag of 100 pcs
GIMA code	SANIBEL™ ADI MUSHROOM EAR TIPS	Minimum order
53520	Ear tip 7 mm - blue	bag of 100 pcs
53521	Ear tip 8 mm - yellow	bag of 100 pcs
53522	Ear tip 9 mm - green	bag of 100 pcs
53523	Ear tip 10 mm - red	bag of 100 pcs
53524	Ear tip 11 mm - blue	bag of 100 pcs
53525	Ear tip 12 mm - yellow	bag of 100 pcs
53526	Ear tip 13 mm - green	bag of 100 pcs
53527	Ear tip 14 mm - red	bag of 100 pcs

## SCREENING AUDIOMETER

### • 53549 MAICO MA27 SCREENING AUDIOMETER

Air conduction audiometer for basic screening with rigid and lightweight case. It has 11 frequencies, built-in carrying handle and compartment to store headphones and accessories. Tough, accurate and reliable with large fingertip control knobs for easy frequency and hearing levels adjustments.

Selectable display languages: GB, FR; IT, ES, DE.

Supplied with AC headset DD45, audiogram pad and power supply.

Multilingual manual: GB, FR, IT, ES, DE, PL, RU.

### • 53555 PELTOR INSULATION HEADBAND\*

### • 53556 AUDIOGRAM CARDS - box of 50

#### TECHNICAL SPECIFICATIONS

Display: 38.1x76.2 mm, monochrome  
 Level steps: 5 or 1 dB  
 Hearing level range: -10 dB HL to 100 dB HL  
 Test signal: pure tone and warble tone (pulsed and continuous)  
 Test frequencies: 125, 250, 500, 750, 1000, 1500, 2000, 3000, 4000, 6000, 8000 Hz  
 Size - Weight: 25.5x37xh 15 cm - 2.4 kg  
 Power supply: 100-240VAC ± 10 %, 50/60 Hz, 0.6 A  
 Standards: IEC 60601-1:2012, AAMI ES60601-1:2005+A2+A1, CAN/CSA-C22.2 No. 60601-1:14 Type B, IEC 60601-1-2:2014, IEC 60645-1:2017 Type 4, ANSI/ASA S3.6-2018 Type 4

Classification: Class IIa (EU 2017/745), Medical Device

\*Should be used with headset transducers supplied with device



## DIAGNOSTIC AUDIOMETER

2 lines of 24 characters backlit display

### 53551

Weight: 735 g  
 Dimension: 270x175x68 mm  
 Operating power: 100-240 V, 50-60 Hz

### • 53551 AMPLIVOX 240 DIAGNOSTIC AUDIOMETER - air, bone, masking

Cost-effective diagnostic audiometer with USB connectivity, ideal for desktop and mobile use.

- threshold retention function
- single, pulsed or warble tone preset
- 11 test frequencies: 125 to 8,000 Hz (AC), 250 to 8,000 Hz (BC)
- -10 to 120 dBHL range (AC), -10 to 70 dBHL (BC), 90 dBHL max (250 to 4,000 Hz) insert masking output
- automatic AC test functionality

Supplied with audiometric headset, bone conductor headset, patient response switch, audiogram cards (box of 50), main power adaptor, carrying case and manual GB, IT, ES. On request FR, SE, RU, PT.

- 53555 PELTOR INSULATION HEADBAND\*
- 53556 AUDIOGRAM CARDS - box of 50
- 53557 INSERT FOR MASKING

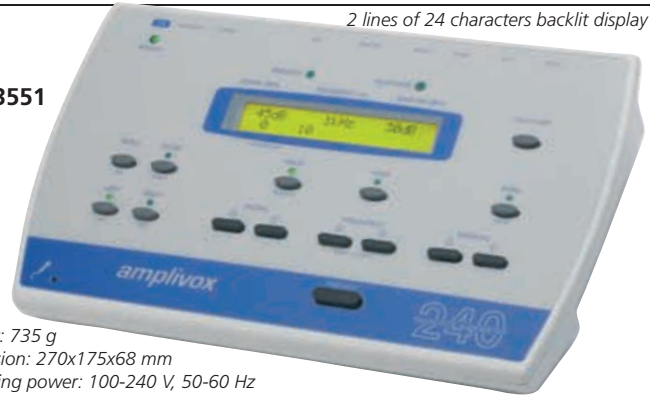

## SCREENING DIAGNOSTIC AND CLINICAL 2 CHANNEL AUDIOMETERS

### • 33623 SIBELSOUND 400-A SCREENING AUDIOMETER - air conduction

### • 33624 SIBELSOUND 400-AOM DIAGNOSTIC AUDIOMETER - air + bone + masking

### • 33626 SIBELSOUND 400-SUPRA CLINICAL AUDIOMETER - air + bone + mask + supraliminal tests + W50 software + Intercom kit

Two-channel digital audiometers based on DSP processing. Designed for quick and easy audiometric exploration of hearing thresholds and screening tests, such as suprathreshold pure tone tests (FOWLER-ABLB, TONE DECAY, WEBER, LUSCHER, ...).

- Air conduction (TDH 39): 125 - 8,000 Hz or HF: 8,000 - 20,000 Hz with optional HDA 200

- Levels: AC (-10 to 120 dB HL) / BC (-10 to 70 dB HL) / speech (-10 to 100 dB HL) free field (-10 to 80 dB HL)

- Masking levels (manual or synchronized): NBN AC (-10 to 100 dB HL) NBN BC (-10 to 70 dB HL) white & speech (-10 to 100 dB SPL)

- Tone: continuous, pulse, antenate, amplitude modulation.

- Level increases: 5 (A-AOM), 1 or 5 (SUPRA)

- Frequency precision: ±1% / level precision ±2% db SPL

- Automatic calculation of hearing loss and diagnosis (COUNCIL, IMSS MEXICO, ELI, SAL, KLOCKHOFF, MOH, OTHERS ...)

#### Communication system:

- Print directly to a USB printer or connect to W50 Software.

- Direct USB connection to PC to W50 audiometry software for viewing, storage, transmission, analysis and introduction of audiometric tests. It also allows to input data performed by other audiometers and show automatic diagnosis (council IMSS,...). Compatible Windows 7, 8.1 and 10 (32/64 bits).

### • 33621 INSULATION DEVICE for air conduction phone

### • 33629 AUDIOMETRY SOFTWARE W50

Dimension: 390x260x105 mm  
 Weight: 2.4 kg without accessories  
 Power: 100-240 V, 50/60 Hz

LCD alphanumeric backlight  
 2 lines of 16 characters



Programme personalization according to users need

User manual GB, IT (available on request FR, ES)

#### FREQUENCIES AND LEVELS

Standard frequency	125	250	500	750	1,000	1,500	2,000	3,000	4,000	6,000	8,000	Hz
Musical frequency	131	262	523	-	1,047	-	2,093	-	4,186	-	8,372	Hz
Air conduction (THD 39)	80	100	120	120	120	120	120	120	120	110	110	dB HL
Bone conduction (B 71)	-	50	60	60	70	70	70	70	70	55	-	dB HL
Free field	-	70	80	80	80	80	80	80	80	80	-	dB HL
<b>MASKING NOISE</b>												
Narrow bandwidth AC	60	80	100	100	100	100	100	100	100	100	90	dB HL
Narrow bandwidth BC	-	50	60	60	70	70	70	70	70	-	-	dB HL
White AC	-	-	-	-	100	100	100	100	100	-	-	dB SPL
Speech	-	-	-	-	100	100	100	100	100	-	-	dB SPL
<b>LOGO-AUDIOMETRY</b>												
Air conduction	100											dB SPL
Free field	80 dB at 1m from the patient											dB SPL
<b>Minimum levels</b>												
All options	-10	-10	-10	-10	-10	-10	-10	-10	-10	-10	-10	dB HL

#### SIBELSOUND 400 FEATURES

	A	AOM	SUPRA
Audiometry type	4 screening	3diagnostic	2 clinical
Air conduction TDH 39	•	•	•
Bone conduction B71	•	•	•
Masking by white narrow band & speech noise	•	•	•
Sisi test	•	•	•
Supraliminal tests	•	•	•
Speechaudiometry	•	•	•
Intercom kit (headphone + microphone)	•	•	•
Musical frequencies	•	•	•
Intercom data base	150 tests	1,000 tests	1,000 tests
USB connectivity	•	•	•
W50 audiometry software	optional	optional	•

## PC CONTROLLED PORTABLE AUDIOMETERS

### PICCOLO PORTABLE AUDIOMETERS

Piccolo is a basic diagnostic audiometer offering air, bone and speech audiometry functions.

Piccolo can be controlled from a computer running Windows. Lightweight, compact design, powerful, user-friendly software and Noah connectivity combine to make Piccolo the ideal choice for professionals on the move.

- two different models available:

**Basic** (AC only) for Pc use

**Plus** (AC/BC) for Pc use

- computer control through the Maestro software.

Compatible for Windows 7, 8, 10

- small and light weight

- power supply through the USB connection, when controlled by computer.

Software language:

GB, FR, IT, ES, DE, PL, PT, RU.

CD manual and quick guide

GB, FR, IT, ES, DE, PL, PT, NL.



MADE IN ITALY

#### TECHNICAL SPECIFICATIONS

	Piccolo Basic	Piccolo Plus
Type of device:	Pc control	Pc control
Class EN 60645-1, ANSI S3.6:	4-screening	3-diagnostic
Output:	AC	AC, BC
Masking:	NBN	NBN
Warble tone:	Yes	Yes
Pulsed tone:	0.5 Hz, 1 Hz, 2 Hz	0.5 Hz, 1 Hz, 2 Hz
Frequency range:	125 - 8,000 Hz	125 - 8,000 Hz
Maximum output intensities:	AC: -10 to 120 dB HL	AC: -10 to 120 dB HL BC: -10 to 80 dB HL
Attenuator step:	5 dB	5 dB
Automatic audiometry:	HW auto threshold	HW auto threshold
Speech audiometry:	No	No
Speech inputs:	-	-
Talk over:	External microphone	External microphone
Connection to PC:	USB [driverless]	USB [driverless]
Controlling software:	Maestro module	
Controlling app:	-	Maestro (App Store)
Dimensions:	16x16x3cm (16.3x6.3x1.2 in)	
Weight:	300 g (10.6 oz)	300 g (10.6 oz)
Operating voltage:	100-240 V, 50/60 Hz	100-240 V, 50/60 Hz

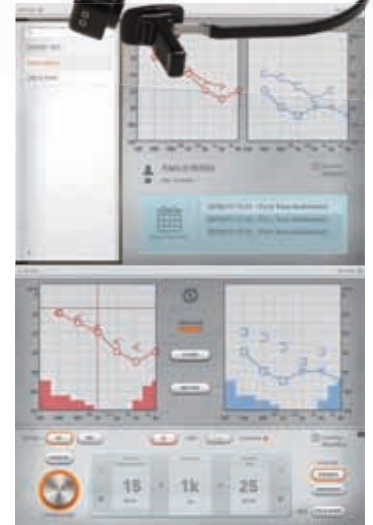

GIMA code	SCREENING AND DIAGNOSTIC AUDIOMETERS	Management
33613	Piccolo Basic screening audiometer - air + mask	PC
33615	Piccolo Plus diagnostic audiometer - air + bone + mask	PC

#### STANDARD ACCESSORIES

- TDH-39 supra-aural headphones
- B71 bone vibrator (33615 only)
- Patient response switch
- Clip-on microphone for operator
- to-patient communication
- Inventis Daisy Patient Record Manager, with Daisy Maestro module
- Noah Maestro module
- USB connection cable
- Medical grande power supply
- User Manual

## BELL PLUS DIAGNOSTIC AUDIOMETER

### • 33635 BELL PLUS DIAGNOSTIC AUDIOMETER - air + bone + mask + software DAISY - MAESTRO

Bell is a basic diagnostic audiometer performing fast and accurate air and bone conduction threshold examinations. Simple operation, fast and reliable automatic examination mode, user-friendly interface and easy portability make Bell the ideal instrument for private clinics, multi-specialist clinics and occupational medicine application.

- pure tone audiometry in AC and BC
- hughson-Westlake auto threshold test
- colour graphic display
- internal memory for 100 patients
- cost effective solution

MADE IN ITALY



Manual:

GB, FR, IT, ES, DE, PT.

33635

- supplied with air conduction phone and vibrator for bone conduction.

#### Maestro Software interface

The Maestro module is the software interface of Bell Plus audiometer. When it is connected to PC via USB you can see real time progress of the exam on the display and then download the data. It also allows full control of the audiometer from computer.

#### STANDARD ACCESSORIES

- TDH-39 supra-aural headphones
- B71 bone vibrator
- Patient response switch
- Plastic cover sheet
- Medical grade power supply
- User Manual

#### TECHNICAL SPECIFICATIONS

Type of device	Hybrid audiometer
Class (EN 60645-1, ANSI S3.6)	3 diagnostic
Output	AC, BC
Masking	NBN, WN
Insert masking earphone	Yes
Warble tone	Yes
Pulsed tone	0.5 Hz, 1 Hz, 2 Hz
Frequency range	125 - 8,000 Hz
Maximum output intensities	AC: -10 to 120 dB HL BC: -10 to 80 dB HL
Attenuator step	5 dB
Automatic audiometry	HW auto threshold
Talk over	Internal or external microphone
Display type	Colour graphic
Display size resolution	4.3", 480x272
Internal memory	100 patients
Operating voltage	100-240 V, 50/60 Hz
Dimensions - weight	32x32x9 cm (12.6x12.6x3.5 in) - 1.8 kg (4.0 lbs)
Compatibility:	Windows 7, 8, 10

# AUDIOMETRIC BOOTHS - CONFORM TO EU 2017/745 - Class I



- **33648 NEW PRO 25 - 96x96x197 cm**
  - **33650 PRO 25 - 96x96x197 cm**
- Portable, lightweight, sound proof booth, easy to install in few minutes. Interior finishing made of acoustic pyramid foam in anthracite grey (33650) or made of sound-absorbing polyurethane, coated with acoustic lining washable and sanitizable (33648). External finishing made of highly resistant, fire proof washable panel. Module for cable connection included.
- **33651 TABLE - 79x50 cm**

- **33649 PRO 28F - 96x96x197 cm**
- New compact booth with an outstanding level of soundproofing and excellent acoustic thanks to innovative materials. Internal finishing made of fire proof, washable, sanitizable and very resistant fabric. Internal ventilation system. External finishing made of highly resistant, fireproof, washable panel. Module for cable connection included.
- **33651 TABLE 79x50 cm**

- **33654 PRO 30 - 107x107x244\*\* cm**
  - **33653 PRO 30 - 132x132x244\*\* cm**
  - **33655 PRO 30 - 211x107x244\*\* cm**
  - **33656 PRO 30 - 211x211x244\*\* cm**
  - **33657 PRO 30 - size on request**
- available any size from 1x1 to 3x3 Interior finishing made of auto extinguishing acoustic pyramid foam in anthracite grey. Range with different sizes, with high noise reduction and ventilation system. External finishing made of highly resistant, fireproof, washable panel and aluminium frame. Module for cable connection included. Sanitizing air-exchanging system on request.
- **33651 TABLE 79x50 cm**
  - **33652 RAMPS**
- for wheelchair access

MADE IN ITALY

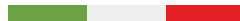

		ACOUSTIC INSULATION							
Hertz		125	250	500	1000	2000	4000	8000	
PRO 25 NEW	dB	19.1	18.7	30.8	31.5	27.9	35.2	43.3	
PRO 25	dB	18.0	16.0	26.7	30.8	28.8	30.9	39.0	
PRO 28	dB	21.7	25.6	32.6	36.2	34.0	41.1	43.0	
PRO 30	dB	23.4	24.1	27.8	34.5	31.3	36.4	37.7	

- STANDARD ACCESSORIES**
- module for silent audiometer cable connection
  - internal illumination
  - ventilation system (PRO 28, PRO 30 only)
  - ISPM-15 wooden box for transport
  - manual: GB, IT

	TECHNICAL SPECIFICATIONS							
	33648	33650	33649	33654	33653	33655	33656	
External size (cm):	96x96x197	96x96x197	96x96x197	107x107x 244**	132x132x 244**	211x107x 244**	211x211x 244**	
Internal size (cm):	85x85x180	81x81x180	81x81x173.5	92x92x201	117x117x201	196x92x201	196x196x201	
Door size cm:	55x168	55x168	55x168	75x200	75x200	75x200	75x200	
Door opening:	Left/Right	Left/Right	Left/Right	Right*		Right*		
Windows size cm:	52x52	52x52	52x52	56x88				
Window material:	2 - crystal insulating safety glass							
Wall thickness cm:	5.5	7.5	7.5	7.5	7.5	7.5	7.5	
Weight (kg):	198	198	233	285	355	435	645	
Ventilation:	no	no	yes	yes	yes	yes	yes	
Tested noise reduction dB at 1,000 Hz:	31.5	30.8	36.2	34.5		34.5		
Internal illumination power V-Hz:	230 - 50/60		86-265 - 50/60		86-265 - 50/60			
Norms:	Class I Medical Devices European Directive EU 2017/745							
	*Left opening available on request				**Height includes air ventilation system (27 cm)			

# UNIVERSAL NOSE MASKS AND FACE MASKS FOR CPAP - SINGLE PATIENT

## NOSE MASKS AND FACE MASKS FOR CPAP

Airtight, light and soft masks adjust automatically according to different face shapes. Honeycomb vents designed to be gentle and quiet. Quick-release connector helps separate the tubing from the mask easily. Headgear is made of soft and skin-friendly fabric to ensure maximum comfort. Masks are suitable for Yuwell, Resmed, Philips, Fisher & Paykel and most of CPAP machines in the market. Therapy pressure range: 4-30 cm H<sub>2</sub>O. Tube connection: 22 mm

GIMA code	BREATHING NOSE MASKS
53710	Breathing nose mask - small
53705	Breathing nose mask - medium
53712	Breathing nose mask - large
BREATHING FACE MASKS	
53713	Breathing face mask - small
53714	Breathing face mask - medium
53715	Breathing face mask - large

Breathing nose masks

Breathing face masks





## SLEEP APNEA SCREEN METER

**• 33676 SLEEP APNEA SCREEN METER**

Suitable for people who have obstructive sleep apnea-hypopnea syndrome (OSAHS), chronic obstructive pulmonary diseases (COPD), asthma, vascular disease or people over 60 years old. For hospital and home use.

- wrist-design, small and light
- multi-function device, to know physiological information
- displays SpO<sub>2</sub>, PR, pulse sound, bar graph
- display of pulse and nasal airflow waveform
- alarm for low-power, finger-out and over-limit
- real-time clock
- 20 hours continuous recording
- multi-care record
- PC analysis software

**• 33677 RUBBER ADULT SpO<sub>2</sub> PROBE for day**

up to S.N. 19040200005

**• 33675 RUBBER ADULT SpO<sub>2</sub> PROBE for day**

since S.N. 19040300001

**• 33678 NON-WOVEN SpO<sub>2</sub> PROBE for night - bag of 2**

up to S.N. 19040200005

**• 33671 NON-WOVEN SpO<sub>2</sub> PROBE for night - bag of 2**

since S.N. 19040300001

**• 34172 NASAL OXYGEN CANNULA**

**STANDARD ACCESSORIES**

- Adult, Neonatal disposable SpO<sub>2</sub> probe
- Adapter
- Adult SpO<sub>2</sub> probe
- USB cable
- Software
- Nose-oxygen tube
- Manual (GB, FR, IT, ES)



33676



Adjustable screen brightness

33676



**TECHNICAL SPECIFICATIONS**

Nasal airflow measure range:	0-40 rpm ±2 rpm
SpO <sub>2</sub> measuring range:	0-100 % ±2 % (70-100 %), resolution 1%
Pulse Rate measuring range:	30-250 bpm ±2 bpm or ±2% (select the larger)
Resistance to surrounding light:	The difference between the value measured in the condition of man-made light and indoor natural light and that of darkroom is less than ±1 %
Display:	1.8" colour LCD
Power consumption:	≤100 mA
Power supply:	3.7 V rechargeable lithium battery
Battery working hour:	continuously work for more than 20 hours
Safety Type:	Internally powered, Type BF applied part
Dimension of device:	69x50x17.3 mm
Weight:	100 g (lithium battery included)

## BREATHCARE PAP DEVICES: CPAP AND AUTO CPAP



53700

**• 53700 BREATHCARE PAP DEVICE - CPAP**

**• 53701 BREATHCARE PAP DEVICE - CPAP/AUTO CPAP**

The breathcare PAP devices take care of patients every night. PAP (Positive Airway Pressure) device works as an air compressor, it constantly blows pressurized air to patient's airway, to prevent airway collapse.

The PAP devices contain CPAP and Auto CPAP (53701 only).

**CPAP:** Continuous Positive Airway Pressure device

**Auto CPAP:** Automatic Continuous Positive Airway Pressure device

**Immediately improve sleep quality**

No trauma, safe and comfortable

**User friendly with little discomfort**

**Quiet, noise ≤ 28 dB**

Ultra quiet thanks to 4 methods for reducing noise level.

**Stable 20,000 hours life time.**

**Comfortable** based on years of clinical data it effectively reduces the average treatment pressure and provides a comfortable therapy experience.

**Connection with oxygen concentrator** to supply oxygen with



Separable body



Medical humidifier for 1 day line



**FOR SLEEP APNEA**



53701

**yuwell**

mask which can help ease symptoms of hypercapnia.

Internal software: GB, IT. Supplied with carrying bag, 2 filters, air hose, heated humidifier, breathing nose mask, SD card (only 53701), power adapter, power cable and manual (GB, IT)

**• 53704 AIR SOFT TUBE - spare**

**• 53706 AIR COTTON FILTER - box of 10 - spare**

Advised replacement every 2-3 months

**• 53707 CONNECTOR to oxygen concentrator**

Breathing nose mask, see page 315.

**TECHNICAL SPECIFICATIONS**

Treatment mode:	CPAP, Auto CPAP (53701 only)
Pressure range:	4-20 cm H <sub>2</sub> O ±0.5 cm H <sub>2</sub> O
Time-lapse boosting:	0-45 min
Alarm protection:	face mask fell alarm
Operating power:	100-240 V, 50-60 Hz DC 24 V
Automatic altimetric compensation:	3500m
USM air circuit system:	ultra silence air circuit system
PCM:	noise removal technology
3A self adapting frequency adjustment technique	
Size - weight:	27x13.5xh 10 cm - 1.5 kg



3.5 inches LCD screen



Portable bag

## DISPOSABLE AND RE-USABLE TURBINES FOR MIR SPIROMETERS

### • 33507 DISPOSABLE TURBINE WITH INTEGRATED MOUTHPIECE - box of 60

Single patient use. Low cost and high accuracy. Individually packed to guarantee maximum hygiene. Easy to replace, no calibration needed.

Compatible with GIMA codes: 33509, 33511-14, 33518-22, 33527-29, 33530, 33532, 33534.

### • 33526 RE-USABLE TURBINE - bayonet

Easy to replace, no calibration needed. Compatible with GIMA codes: 33510-14, 33518, 33520-22, 33528-32, 33534.



33526

33507

## MOUTHPIECES FOR MOST SPIROMETER BRANDS

Paper mouthpieces (disposable) and plastic mouthpieces (re-usable) for most brands of spirometers and peak flow. Paper mouthpieces are packed in individual transparent pouch.



MADE IN EUROPE

33432

### GIMA PAPER MOUTHPIECES

GIMA code	Sizes - cm Ø int x ext x h	Suitable for	Compatibility		Minimum order
			GIMA codes	Other brands	
33410	2.8x3x6.5	adult	33431, 33433, 33471-2, 33510, 33512-14, 33518-22, 33528-32, 33534	Micromedical Vitalograph, Mir	box of 500
33897				Ferraris (Koko legend) Cardiette	dispenser of 100
33411	2.0x2.2x6	paediatric		Micromedical Vitalograph, Mir	box of 250
33412	Plastic adapter		33411	Mir	-
33506	2.6x2.8x6.5	adult	33484-7	Sibel, BTL	box of 100
33890	2.5x2.7x7	adult	-	Fukuda Sangjo, Thor	dispenser of 100
33892	2.8x3.05x7	adult	-	Cosmed (Pony model)	dispenser of 100
33898	2.8x3.05x7	adult	-	Cosmed (Pony model)	box of 500
33895	3.03x3.3	adult	-	Sensormedics, Microcard	box of 500
33899	2.42x2.6	adult	-	Sorin Lifewatch, Fukuda Denshi	box of 500

### GIMA PLASTIC MOUTHPIECES

GIMA code	Size - cm Ø int x ext	Suitable for	Compatibility	Minimum order	
33432**	1.7x2.1x5 2.7x3x5	adult/ped	33431, 33433	Ferraris	-
33691		adult	33682-4, 6, 8	Thor	box of 10

\*Gimaspir A/B need adapter 33495

\*\*Made in USA

## SPIROMETRY PAPERS

### • 33492 MIR SPIROLAB PAPER - roll 112mm x 25m

Suitable also for SIBEL DATOSPIR 120 B, C, D, DATOSPIR Touch and GIMASPIR 120 models B, C, D.

### • 33891 COSMED PONY PAPER - roll 57 mm x 11 m - box of 25 rolls

Compatible also with Fukuda Spirosift.

### • 33250 THERMAL PAPER - roll 58 mm

Suitable for SIBEL DATOSPIR 120 A and GIMASPIR 120-A.

## BACTERIAL FILTER

### • 33525 BACTERIAL FILTER - box of 50 for MIR, Medisoft spirometers

### • 33557 SPIROGUARD BACTERIAL FILTER - box of 50

#### Compatibility of Spiroguard

Erich Jaeger GmbH	Masterlab and Masterscreen
Ferraris Medical - P.K. Morgan	Autolink-Benchmark Transflo and USA Transfer System
Sensormedics	2200 - 2400 - 2450
Vitalograph	Wedge-Bellow-Alpha and Escort Spirometers

## BACTERIAL FILTER - MOUTHPIECE FOR MOST SPIROMETER BRANDS



CE 0476

### BACTERIAL FILTER - MOUTHPIECE

Disposable anatomical filter with integrated mouthpiece to prevent bacterial and viral contamination. Easy to use, direct connection to spirometer on one side, to patient on the other side. Suitable for most of spirometers and devices. Class II A. Individually packed in transparent bag.

MADE IN ITALY

### BACTERIAL FILTERS - MOUTHPIECES - box of 100

GIMA code	Size - cm Ø int x ext	Compatibility with	
		GIMA codes	Other brands
33884	2.75x3	33341, 33433, 33471-2, 33509-14, 33518-22, 33528-32, 33534	Micromedical, Vitalograph, Mir, Ferraris (koko legend), Cardiette (Pneumos 300)
33885	2.7x3.05	-	Cosmed
33886	2.95x3.3	-	Customed, Jaeger
33887	3.05x3.4	-	Sensormedics, Thor, Morgan, Chest, Microgard
33888	3.4x3.6	-	Medical Graphics
33889	2.5x2.7	-	Fukuda Sangjo
33902	2.22x2.8	-	BTL, Sibel

## DISPOSABLE NOSE CLIPS FOR SPIROMETRY TESTS

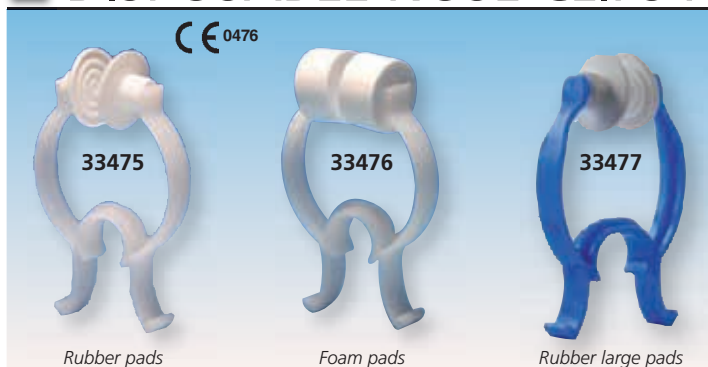

CE 0476

33475

33476

33477

Rubber pads

Foam pads

Rubber large pads

### • 33475 NOSE CLIPS - rubber - 70x40 mm - bag of 100

### • 33476 NOSE CLIPS - foam - 70x40 mm - bag of 100

### • 33477 NOSE CLIPS - rubber large - 70x45 mm - bag of 100

Gima rubber or foam-padded disposable nose clips help prevent patients from inhaling or exhaling through the nose during spirometry. The tension in the nose clip body keeps it firmly in place while the rubber or foam pads are designed for the best patient comfort. Made of thermoplastic, latex free. Rubber nose clip is available in 2 sizes: standard or large.



33476

MADE IN ITALY

# SP-10 POCKET SPIROMETER LUNG EXERCISE DEVICE

## • 33442 RESPIROGRAM

The respiratory-exerciser Respirogram exercises the respiration through inspiration. It helps the patient to recover the normal respiration after a chest or abdominal surgery. Composed of: 1 base, 3 small balls different in dimension and colours, 1 transparent central part divided into 3 rooms, 1 tube and mouthpiece. Packed in single box.

MADE IN ITALY

Base and small balls made of non-toxic polypropylene. Central part made of copolymer non-toxic. Tube and mouthpiece made of polyethylene.

Multilingual box and instructions: GB, FR, IT, ES, PT, DE, GR, Arabic.



CE 0123  
AVAILABLE WITH BLUETOOTH

33536

- 33536 SP-10 POCKET SPIROMETER
  - 33535 SP-10 POCKET SPIROMETER WITH BLUETOOTH
- Pocket, portable spirometer with large TFT screen to clearly display both numbers and flow charts. Synchronously measure FVC, PEF, FEV1, FEV1%, FEF25, FEF2575, FEF75. Support diagnosis evidence by volume and flow rate chart display. Built-in predicted values. Free PHMS App to save data. Built-in lithium rechargeable battery and battery power display. Supplied with USB cable for PC connection, battery charger and software to calculate data and analyse trend.

• 33410 ADULT MOUTHPIECES - Ø 3 cm ext. - box of 500 pcs

STANDARD ACCESSORIES	
Internal lithium battery	
USB cable	
PC software (english language)	
User manual: GB, FR, IT, ES.	

**TECHNICAL SPECIFICATIONS**

Max volume: 10 l  
 Volume accuracy: ±3% or 50 ml whichever is greater  
 Flow range: 1 l/sec - 16 l/sec  
 Flow accuracy: ±10% or 0.3 l/sec whichever is greater  
 Parameters: FVC, FEV1, PEF, FEV1%, FEF25, FEF2575, FEF75  
 CE 92/42 - EMC group I class B - protection type BF

CE

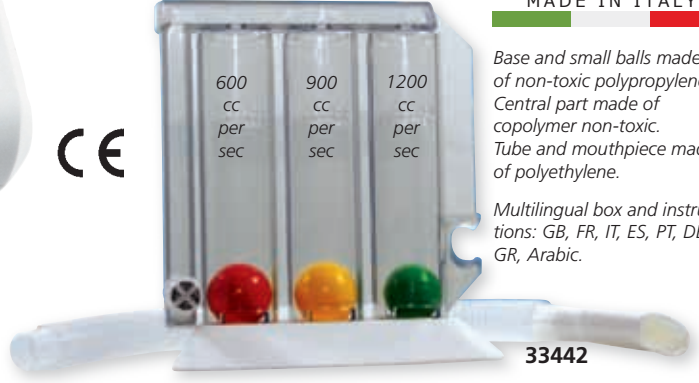

33442

- 33436 TRI-BALL® - respiratory exerciser - box of 12
- Tri-Ball® helps the patient to recover the normal respiration after a chest or abdominal surgery. Easy to handle, light and break-resistant design. Germ-proof mouthpiece holder. It includes a particle filter. Label identification to write patient name and room. Single patient. User manual in GB, FR, DE, IT, ES.

MADE IN SPAIN



33436

CE

## PEAK FLOW METERS

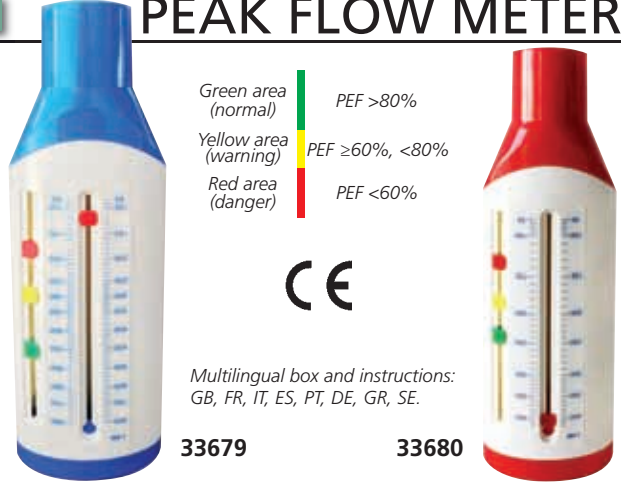

Green area (normal) PEF >80%  
 Yellow area (warning) PEF ≥60%, <80%  
 Red area (danger) PEF <60%

CE

Multilingual box and instructions: GB, FR, IT, ES, PT, DE, GR, SE.

33679

33680

- 33679 PEAK FLOW METER - 60-800 l/min - adult
  - 33680 PEAK FLOW METER - 50-400 l/min - pediatric
- Regular use of a Peak flow meter can help keep tabs on your asthma by detecting airway narrowing even before you feel any symptoms, giving you time to adjust your medication before your symptoms get worse. Single patient, suitable for adults (33679) and children (33680) as young as 5.
- measure day-to-day changes in your breathing
  - track the control of your asthma over time
  - show how well your treatment is working
  - recognize signs of a flare-up before symptoms appear
  - know what steps to take when you have signs of an asthma flare-up
  - decide when to call your doctor or get emergency care.

## SPACER FOR AEROSOL

Large mask recommended for patients 5 years +      Medium mask for a secure seal      Small mask anatomically shaped for a secure seal



CE

33672

33673

33674

- 33672 SPACER FOR AEROSOL 175 ml - adult (5 years +)
  - 33673 SPACER FOR AEROSOL 175 ml - child (1-5 years)
  - 33674 SPACER FOR AEROSOL 175 ml - baby (0-18 months)
- Anti-static simple and portable aerosol chamber suitable for people with respiratory diseases. It can manage asthma, allowing patients to inhale medicines in a more effectively way. Using a spacer enables to breathe in the mist directly into the lungs and not wasting in the back of the mouth. It helps providing relief from asthma symptoms. It shouldn't be used by people with severe asthma or breathing difficulties. Flow signal whistle to alert patients to breathe slowly included. Chamber size: 52x131 mm. Single patient use only, not sterile. Multilingual box and instructions: GB, FR, IT, ES, PT, DE, GR, SE.

## SPIROBANK II SMART - PORTABLE SPIROMETER WITH SPO<sub>2</sub> OPTION

- **33512 SPIROBANK II SMART + WINSPIROPRO SOFTWARE**  
Spirometer with 10.000 tests memory capacity, monochromatic LCD display, 6 keys membrane keypad. Battery power supply (3,7 V-1100 mA lithium) with an autonomy of approx. 50 hours of continuous use, rechargeable with USB port.  
- cable (USB 2.0) or wireless (Bluetooth 4.0)\* connection  
- internal temperature sensor for automatic BTPS conversion  
- high resolution graphic display  
- automatic record of a whole spirometry session including best test  
- USB cable, carrying case, CD manual (GB, FR, IT, ES, DE, PT) re-usable turbine and software included. Selectable internal software (GB, FR, IT, ES, DE, PT)
- **33514 SPIROBANK II SMART + WINSPIROPRO SOFTWARE + OXYMETER**  
Same as above with more than 300 hours of oximetric test records (SpO<sub>2</sub> % and pulse frequency tests).  
Measured parameters: min, max and average SpO<sub>2</sub> %, min, max and average pulse frequency, SpO<sub>2</sub> total events, test duration, bradycardia events (<40 BPM), tachycardia events (>120 BPM), T90% (time passed with SpO<sub>2</sub> ≤89%), T89% (time passed with SpO<sub>2</sub> ≤ 88%)
- **33525 ANTIBACTERIAL FILTER** - box of 50 disposable
- **33507 DISPOSABLE TURBINE with mouthpiece** - box of 60
- **33526 REUSABLE TURBINE**
- **33410 MOUTHPIECES int. Ø 2.8 x ext. Ø 3, h 6.5 cm**

**WinspiroPRO software functions:**  
(GB, FR, IT, DE, ES, PT, PL, SE, NL, LV, CZ, TR, RU, CN, JP)  
- on-line PC connection with icon interface  
- real time Flow/Volume and Volume/time curves  
- bronchial challenge with FEV1 dose-response  
- paediatric incentive animations  
- integration with EPR systems  
- Lung Age Estimation  
- data and graphs export also via e-mail



PC system requirements:  
XP, Seven, Vista, 8, 10

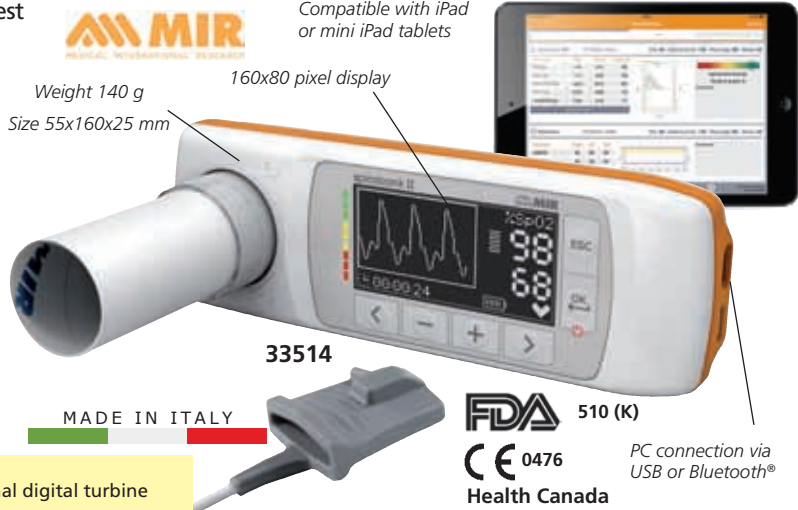

Weight 140 g  
Size 55x160x25 mm  
160x80 pixel display  
Compatible with iPad or mini iPad tablets

### TECHNICAL SPECIFICATIONS - SPIROMETRY

Measured parameters FVC, FEV1, FEV1/FVC%, DTPEF, FEV 0.5, FEV0.5/FVC%, FEV0.75, FEV0.75/FVC%, FEV2, FEV2/FVC%, FEV3, FEV3/FVC%, FEV6, FEV1/FEV6%, PEF, FEF25%, FEF50%, FEF75%, FEF25-75%, FEF75-85%, FET, Vext, Lung Age, EVOL, FIVC, FIV1, PIF, FIV1/FIVC%, FIF25%, FIF50%, FIF75%, R50, PIF, IRV, VC, IVC, IC, ERV, FEV1/VC%, VT, VE, Rf, ti, te, ti/t-tot, VT/ti, MVV	Flow sensor bi-directional digital turbine Flow range ±16L/s Volume accuracy ±3% or 50 mL Flow accuracy ±5% or 200 mL/s Dynamic resistance <0.5 cm H <sub>2</sub> O/L/s Available tests: FVC, VC, IVC, MVV, PRE - POST Connectivity USB 2.0, Bluetooth® 4.0 Power supply Lithium-Ion 3.7V, 1100 mAh
--	--

### TECHNICAL SPECIFICATIONS - OXYMETRY (33514 only)

Measurement method: red and infrared absorption  
SpO<sub>2</sub> range: 0-99% ±2 % between 70-99% SpO<sub>2</sub>  
Pulse rate range: 18-300 BPM ±2 BPM or 2%  
Signal quality indicator: 0-8 segments on display  
Memory capacity: up to 300 hours oximetry

## SPIROBANK II BASIC



Size: 160x55x25 mm  
only 140 g including battery

- **33510 SPIROBANK II BASIC + WINSPIROPRO software**  
Complete and rapid pocket spirometer for the General Practitioner to carry out spirometry testing anywhere.  
**No calibration required, use disposable turbine FlowMIR with integrated mouthpiece (33507) or reusable turbine (33526).**  
- measures the most important spirometric parameters including: FVC, VC, IVC, IC, ERV, FEV1, FEV1%, PEF, FEF 25-75, FET, EVOL, TEST POST BD  
- **traffic lights** for immediate test interpretation  
- memory up to **10,000 tests**  
- rechargeable **long life battery** (40 hours continuous operation)  
- real time tests via **USB**  
- selectable display language and CD manual (GB, IT, ES, FR, DE, PT)  
Supplied with Winspiro PRO software, USB cable, 1 disposable turbine in a carrying bag.
- **33507 FLOWMIR DISPOSABLE TURBINE with integrated mouthpiece** - box of 60 - spare
- **33526 REUSABLE TURBINE - optional**
- **33410 MOUTHPIECES int. Ø 2.8 x ext. Ø 3, h 6.5 cm**

### TECHNICAL SPECIFICATION

Power supply: 3.7 V, 110 mA lithium battery , USB rechargeable	Display: LCD monochrome 160x80 pixel
Keypad: 6-key membrane keyboard	Flow accuracy: ± 5% or 200 ml/s whichever is greater
Flow range: +16 l/s	Volume accuracy: ± 3% or 50 ml whichever is greater
Max volume: 10 l	Volume accuracy: ± 3% or 50 ml whichever is greater
Data transmission: USB 2.0	

## SMART ONE PEAK FLOW-FEV1

- **33681 SMART ONE® - Peak Flow and FEV1** Manual in GB, FR, IT, ES, DE, PT, PL, RU, TR, CN
  - **33684 SMART ONE® OXI - Peak Flow and FEV1**
- Ideal for monitoring respiratory illnesses and in self management of Asthma, COPD, lung transplant care, cystic fibrosis and for use in clinical trials.
- 33681 Peak flow and FEV1 on your smartphone**  
Simple handheld wireless device connected via Bluetooth to iOS and Android smartphones and tablets.  
**App with an exclusive incentive for adult and children** based on exhaled flow and volume that gives accurate and helpful results.  
**Graphic trend of Peak Flow and FEV1**  
Measurements with option to flag any test session. Test results history with Peak Flow, traffic light health indicator, symptoms scoring and notes. Low battery consumption.  
**New turbine flowmeter with plastic mouthpiece**  
For personal use, easy to remove for cleaning.
- **33896 REUSABLE MOUTHPIECE** - plastic - box of 10
- **33897 DISPOSABLE MOUTHPIECE** - paper - box of 100



Graphic trends of Peak Flow and FEV1 which can be shared by email

### TECHNICAL SPECIFICATION

<b>General</b>	2 batteries AAA 1.5 V included
Power supply:	1,000 tests
Autonomy:	Low energy Bluetooth® 4.0
Connectivity:	49x109x21 mm - 61 g (batteries included)
Size - weight:	Ø 30 mm (1.18 inch)
Mouthpieces:	
<b>Spirometry</b>	
Flow sensor:	bi-directional digital turbine
Flow range:	±16 L/s
Volume accuracy:	±3% or 50 ml
Measured parameters:	FEV1, PEF
Memory capacity:	the application on the smartphone memorizes data
App iOS - Android:	GB, FR, IT, ES, PT, DE, NL, CZ, PL, RU, TR, DK, GR, FI, HR, NO, SE JP

Internal software and CD manual: GB, FR, IT, ES, DE, PT (only manual)

**SPIROMETER + OXIMETER + 3D ACCELEROMETER IN ONE UNIT**

# SPIRODOC® - SPIROMETER AND OXIMETER

- 33532 SPIRODOC SPIROMETER + SOFTWARE WINSPIRO PRO - bluetooth
- 33533 SPIRODOC OXIMETER + SOFTWARE WINSPIRO PRO
- 33534 SPIRODOC SPIROMETER + OXIMETER + SOFTWARE - bluetooth

One touch laboratory for respiratory analysis suitable for professional and personal use, supplied with reusable turbine.

**Complete spirometer ATS/ERS compliant**

Specialist-level analysis, screening and Home-care monitoring. Various operation modes: "advanced" parameters for the specialist, "reduced" set of parameters for screening as well as a "simplified" version for Home-care operation. FVC, VC, IVC, MVV, PRE-POST.

Precise spirometry interpretation including post bronchodilator. All tests are automatically memorized. Automatic BTPS conversion. Memory capacity: 10.000 tests. Wide selection of predicted values. Possibility to enter patient name.

**Intelligent pulse oximeter with on-screen results**

Simple, clear SpO<sub>2</sub> and Pulse Rate measurements with plethysmographic curve. During the single six-minute walk test (6 MWT), Spirodoc® estimates the level of oxygen therapy required by the patient. Spirodoc® carries out sleep desaturation studies and memorizes events as well as body position.

**3D Accelerometer with motion analysis**

Spirodoc® is the first 3D Oximeter® incorporating a triaxial motion sensor to correlate the saturation level (%SpO<sub>2</sub>) with physical activity (walk counter, movement analysis and VMU).

**Home-care symptoms diary**

Fast on-screen symptoms entry. Touch screen with settable questions and automatic answer recording for homecare patient use (eDiary).

**High performance PC software for spirometry and oximetry**

All tests memorized are automatically downloaded into WinspiroPRO and a patient data card is created with a preview of the spirometry curve. WinspiroPRO can easily be connected to a database, EPR, hospital or occupational health system. This software also gives trend graphs of any parameter. All stored



33534

**EASY TOUCH-SCREEN DISPLAY**

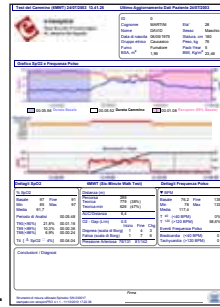

Three phase report of 6 minutes walk test: baseline, walk, recovery

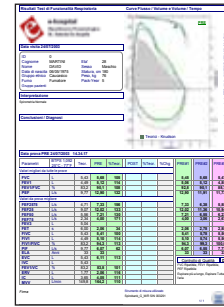

Spirometry report  
**MADE IN ITALY**

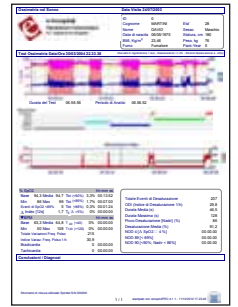

Nocturnal oximetry report with desaturation analysis

tests and curves of every patient can be reviewed on a single page and the results, including oximetry tests, can be compared. Multilingual software: GB, FR, IT, ES, DE, PT, PL, NL SE, CZ, LV, TR, RU, CN, JP.

**TECHNICAL SPECIFICATIONS**

**Central unit**

Display: LCD backlit touch screen display 128x64 pixels  
Power supply: Lithium ion 3.7 V, 1100 mA rechargeable battery with 50 hours measurement back up  
Accelerometer: Triaxial ±2 g, 400 Hz sampling  
Dimension and weight: central unit 101x48x16 mm, 99 g removable turbine head: 46x47x24 mm, 17 g  
**Spirometry**  
Flow sensor: Bi-directional digital turbine  
Flow range: ±16 L/s  
Volume accuracy: ±3% or 50 mL, whichever is greater  
Flow accuracy: ±5% or 200 mL, whichever is greater  
Dynamic resistance at 12 L/s: <0.5 cm H<sub>2</sub>O/L/s

Temperature sensor: semiconductor (0-45°C)

**Spirometer measured parameters**

FVC, FEV1, FEV1/FVC%, FEV3, FEV3/FVC%, FEV6, FEV1/FEV6%, PEF, FEF25%, FEF50%, FEF75%, FEF25%-75%, FET, Estimated Lung Age, Extr. Vol., FIVC, FIV1, FIV1/FIVC%, PIF, VC, IVC, IC, ERV, FEV1/VC%, VT, VE, Rf, ti, te, ti/t-tot, VT/ti, MW measured, MW calculated  
**Oximetry**  
SpO<sub>2</sub> range: 0 -100%, ±2% (50-100% SpO<sub>2</sub>)  
Pulse rate range: 20-254 BPM, ±2 BPM or 2%

**Pulseoximeter measured parameters**

SpO<sub>2</sub> [Baseline, Min, Max, Mean], Pulse rate [Baseline,

Min, Max, Mean], T90% [SpO<sub>2</sub><90%], T89% [SpO<sub>2</sub><89%], T88% [SpO<sub>2</sub><88%], T5% [ΔSpO<sub>2</sub>>5%], Δindex [12s], SpO<sub>2</sub> events, Pulse rate events [Bradycardia, Tachycardia], Step counter, Movement [VMU], Recording time, Analysis time  
**Sleep analysis**  
Body position, SpO<sub>2</sub> events, Desaturation index (ODI), Desaturation [Mean Value, Mean duration, Longest duration, Nadir Peak], ΔSpO<sub>2</sub> [Min duration, Max Drop], Total Pulse Variations, Pulse Rate Index, NOD89% [SpO<sub>2</sub><89%; >5min], NOD4% [SpO<sub>2</sub> Basale-4%; >5min], NOD90% [SpO<sub>2</sub><90%; Nadir<86%; >5min]

# MINISPIR® LIGHT

• 33527 MINISPIR with Winspiro Light  
Minispir Light measures 10 essential parameters for a diagnostic spirometry: FEV6, FVC, FEV1, FEV1%, PEF, FEF25/75%, FIVC, Lung Age, VC, IVC PRE-POST BD. Pediatric incentives. Flow/Volume loop and Volume/Time curve. Spirometry test interpretation. Temperature sensor for BTPS conversion. Minispir Light meets the requirements of integrated healthcare platforms and tablet applications. For use with FlowMir disposable turbine only (33507).  
**Winspiro Light** is an easy and intuitive software, for complete diagnosis included in Minispir Light.

**FOR ESSENTIAL RESPIRATORY TESTING**

MADE IN ITALY

# AND MINISPIR®-USB

• 33528 MINISPIR with Winspiro PRO  
• 33529 MINISPIR+OXYMETER with Winspiro PRO  
Real time Flow/Volume loop and Volume/time curve with PRE/POST comparison. Advanced spirometry test interpretation. Pediatric incentive animations. Lung Age. Bronchial provocation test including new Mannitol protocol with FEV1 response curve. Temperature sensor for BTPS conversion. Supplied with reusable turbine.

**32 measured parameters:** FVC, FEV1, FEV1%, FEV3, FEV3%, FEV6, FEV1/FEV6%, PEF, FEF25%, FEF50%, FEF75%, FEF25-75%, FET, Vext, Lung Age, FIVC, FIV1, FIV1%, PIF, VC, IVC, IC, ERV, FEV1/VC%, VT, VE, Rf, ti, te, ti/t-tot, VT/ti, MVV.

**FOR COMPLETE RESPIRATORY ANALYSIS**

CD manual GB, FR, IT, ES, DE, PT.

**Winspiro PRO** is a unique spirometry and oximetry software, which comes standard with Minispir. All patient records are shown on simple, single-screen patient cards with dynamic management of all data and graphs.

MADE IN ITALY

**PC SYSTEM REQUIREMENTS FOR WINSPIRO LIGHT/PRO**  
Microsoft Windows: XP, Vista 32/64 bit, Seven 32/64 bit, 8  
Screen resolution: 1024x768 Hard disk: 128 MB (better 256 MB)  
USB socket  
Multilingual: GB, FR, IT, ES, PT, DE, PL, SE, NL, CZ, LV, TR, RU, CN, JP

**TECHNICAL SPECIFICATIONS MINISPIR/MINISPIR LIGHT**

Temperature sensor: semiconductor (0-45°C)  
Flow sensor: bi-directional digital turbine  
Flow range: ± 16 L/s  
Volume accuracy: ± 3% or 50 mL  
Flow accuracy: ± 5% or 200 mL/s  
Dynamic resistance at 12 L/s: <0.5 cm H<sub>2</sub>O/L/s  
Communication port: USB  
Power Supply: line powered from USB port  
Dimension: 50x142x26 mm  
Weight: 65 g

**TECHNICAL SPECIFICATIONS MINISPIR SpO<sub>2</sub>**

SpO<sub>2</sub> range: 0-99%  
SpO<sub>2</sub> accuracy: ± 2% tra 70-99% SpO<sub>2</sub>  
Pulse Rate range: 30-300 BPM  
Pulse Rate accuracy: ± 2 BPM or 2%  
**Measured parameters**  
SpO<sub>2</sub> [Baseline, Min, Max, Mean], Pulse Rate [Baseline, Min, Max, Mean], T90 [SpO<sub>2</sub><90%], T89 [SpO<sub>2</sub><89%], T88 [SpO<sub>2</sub><88%], T5 [ΔSpO<sub>2</sub>>5%], Δ Index [12s], SpO<sub>2</sub> Events, Pulse Rate Events [Bradycardia, Tachycardia]

**GIMA code SPARE PARTS AND ACCESSORIES**

- 33507** Flowmir disposable turbine with integrated mouthpiece - box of 60
- 33526** Reusable turbine (only for 33528-9)
- 33410** Adult mouthpieces Ø ext 3 cm - box of 500 pieces for 33526 - spare

# SPIROLAB SPIROMETER: 7" TOUCHSCREEN AND SpO<sub>2</sub> OPTION



MADE IN ITALY

CE 0476  
 FDA 510 (K)  
 Health Canada



Dimensions: 220x210x51 mm  
 (8,66x8,26x2")  
 Weight: 1450 g (3,1lb)  
 (battery pack included)

- 7" TOUCHSCREEN DISPLAY
- PEDIATRIC INCENTIVE SYSTEM
- DATABASE FOR 10,000 TESTS
- USB 2.0, BLUETOOTH 2.1



Miniflowmeter for reusable and disposable turbine (Ø 30 mm)

33519

- 33519 SPIROLAB® SPIROMETER WITH 7" TOUCHSCREEN
  - 33520 SPIROLAB® SPIROMETER WITH 7" TOUCHSCREEN AND SpO<sub>2</sub>
- Fast, simple, durable diagnostic spirometer with Miniflowmeter.

**Features**

- FVC, VC, MVV, PRE/POST Bronchodilator comparison with a wide range of selectable parameters
- long life rechargeable battery
- colour Touchscreen 7" display
- direct connection to external USB Printer PostScript
- 10,000 Spirometry tests or 500 hours of oximetry recording
- wireless Real Time test on PC via Bluetooth®
- fast and silent built-in B/W printer with customizable printout format

- selectable internal software languages: GB, FR, IT, ES, DE, PT

**Oximetry option**

Available adult and pediatric reusable finger probe.

**Fast and user friendly**

Each function can be activated by a simple touch.

**FlowMIR® disposable turbine**

- complies with ATS/ERS standard
- Totally disposable (mouthpiece, turbine) guarantees 100% hygiene, no cross contamination.
- No calibration required.

**Suitable for children**

Patented pediatric incentive directly on the screen.

No need of adaptor.



Each turbine is factory calibrated with a computerized system and is individually packed in a clean room

33507

- 33530 SPIROLAB® 7" + MINISPIR® SPIROMETERS
- 33531 SPIROLAB® 7" WITH SpO<sub>2</sub> + MINISPIR® SPIROMETERS

Same as Spirolab® but combined with Minispir® instead of Miniflowmeter. It allows speed of test execution. Minispir® is portable and can be used alone connected to PC for home visits.



See Minispir specifications at page 320

33530

**COST EFFECTIVE\***

\*Save over 10% on combined purchase Spirolab® + Minispir®

**WinspiroPRO®**

High performances PC software for spirometry and oximetry with free update.

Multilingual software: GB, FR, IT, ES, DE, PT, PL, NL, LV, SE, CZ, RU, TR, JP, CN.



Summary of all tests carried out Printout: spirometry report

**STANDARD ACCESSORIES**

- Battery charger
- 1 roll thermal paper
- Reusable turbine
- Nose clip
- Carrying case
- Software WinspiroPRO®
- USB port and cable
- SpO<sub>2</sub> adult sensor (33520, 33531 only)
- CD manual: GB, FR, IT, ES, DE, PT
- Minispir pouch (only 33530-1)



GIMA code	MIR code	ACCESSORIES AND SPARES	Minimum order
33695	919024	SpO <sub>2</sub> probe - adult - spare	
33696	939006 + 919200	SpO <sub>2</sub> probe - paediatric	
33697	910595	Miniflowmeter with cable - spare	
33410	-	Adult mouthpiece - Ø 30 mm ext	box of 500
33492	-	Thermal paper - 112 mm x 25 m	-
33525	-	Antibacterial filter - disposable	box of 50
33507	910004	Disposable turbine with integrated mouthpiece	box of 60

**TECHNICAL SPECIFICATIONS - OXIMETRY (33520, 33531 only)**

- SpO<sub>2</sub> range: 0-99%
- SpO<sub>2</sub> accuracy: ± 2% between 70-99% SpO<sub>2</sub>
- Pulse Rate range: 18-300 BPM
- Pulse Rate accuracy: ± 2 BPM or 2% whichever is greater
- Memory capacity: up to 500 hours oximetry

**OXIMETRY PARAMETERS (33520, 33531 only)**

%SpO<sub>2</sub> and Pulse Rate (Min, Max, Average), Test duration, Total SpO<sub>2</sub> Events, T90% (SpO<sub>2</sub> time ≤89%), T89% (SpO<sub>2</sub> time ≤88%), T40 (Bradycardia duration with Pulse Rate <40 BPM), T120 (Tachycardia duration with Pulse Rate >120 BPM)

**TECHNICAL SPECIFICATIONS - SPIROMETRY**

- Power supply: Rechargeable battery, approx. 10 hours autonomy
- Battery charger: 100-240 V, 50-60 Hz, 400-200 mA
- Temperature sensor: semiconductor (0-45°C)
- Flow sensor: bi-directional digital turbine
- Flow range: ±16L/s ±5% or 200mL/s
- Volume accuracy: ±3% or 50mL
- Dynamic resistance: <0.5 cm H<sub>2</sub>O/L/s
- Connectivity: USB 2.0, Bluetooth® 2.1
- Display: 7" colour touch screen LCD, 800x480 resolution
- Mouthpieces: Ø 30 mm (1.18 inch)
- Electrical protection: Class II
- Norms: Electrical safety standard EN 60601-1  
Electromagnetic compatibility EN 60601-1-2

**SPIROMETRY PARAMETERS**

FVC, FEV1, FEV1/FVC, FEV1/VC, PEF, FEF25, FEF50, FEF75, FEF75-85, Lung Age, Extrapolated Volume, FET, Time to PEF, FEV0.5, FEV0.5/FVC, FEV0.75, FEV0.75/FVC, FEV2, FEV2/FVC, FEV3, FEV3/FVC, FEV6, FEV1/FEV6, FEV1/PEF, FEV1/FEV0.5, FIVC, FIV1, FIV1/FIVC, PIF, FIF25, FIF50, FIF75, FEF50/FIF50, VC, IVC, IC, ERV, IRV, Rf, VE, VT, tl, tE, VT/tl, tE/tTOT, MVV (measured), MVV (calculated).

**WINSPIROPRO® REQUIREMENTS**

Windows 2000, XP, Vista (32/64 bit), 7 (32/64 bit), 8 and 8.1 (32/64 bit), 10 (32/64 bit). RAM 512 MB

## HOLTER ECG SYSTEM - 24 HOURS MONITORING

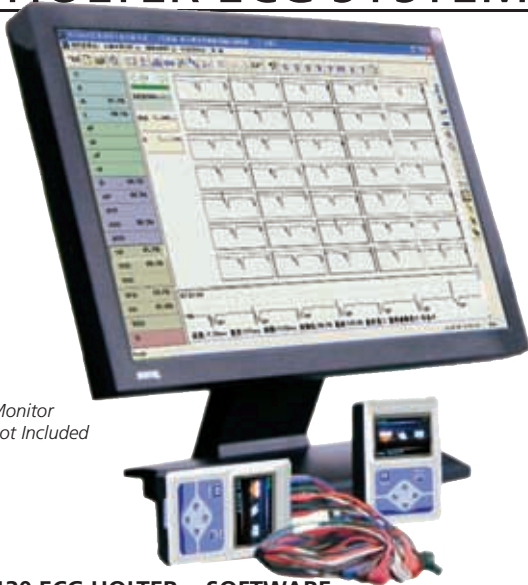

Monitor not Included

35130

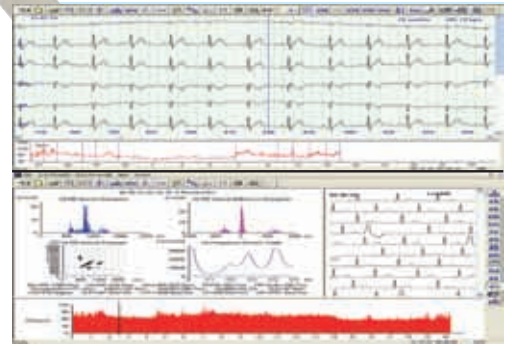

**Recorder:**

- 12 channel Synchronized ECG Acquisition
- small ECG recorder with OLED colour screen to display real time ECG waveform and review storage data.
- capacity up to 2G
- selectable sampling rate, 200, 500, 1,000 sampling/sec
- sampling accuracy: 12 bit
- built-in FLASH storage media, to prevent the flash card from damage due to repeated insertion and pull out
- USB interface
- operating system: Win 98, 2000, XP, 7, 8, 10

**35131 ECG CABLE - spare**

**TECHNICAL SPECIFICATIONS**

Scale voltage:	1mV±5%	Least measure signal:	50µV p-p
Standard sensitivity:	10mm/mV ±5%	Interference between channels:	scan track deflection (result from interference between channels) <0.5mm
Noise level:	≤30µV	Product safety type:	type B (internally powered)
CMRR:	≥60dB	Size:	111 x 60 x 25 mm
Frequency response:	10Hz as benchmark, 0.5Hz-55Hz; -3dB	Net weight:	105 g (without battery)
Time constant:	>3.2s		
Scan speed:	25mm/s ±5%		
Enduring polarization voltage:	±300mV		

**35130 ECG HOLTER + SOFTWARE**

ECG Holter system includes ECG recorder and software connectable to a computer system or laser printer. The recorder has built-in flash storage media to increase memory capacity. The sampling rate of 1,000 sampling/sec has improved the quality of waveform. Accuracy of the system is ensured by AHA and MIT data.

**Features:**

- windows software interface (GB, IT, PL, PT, RU)
  - quick and accurate analyzing system
  - special editing system of R point
  - perfect analysis function of ST segment
  - analysis function of T wave of all channels and T wave trend graph
  - review of ECG trend graph
  - analysis system of HR variability, providing regular SDNN, SDANN, RMSSD, LF, HF, time domain and frequency domain
  - QT analysis
  - acquire pacing ECG directly without separate channel;
- Functions of VCG, VLP, TVCG, HRT, TWA

35130



**STANDARD ACCESSORIES**

- 1 Holter recorder
- 1 CD with software (GB, IT, PL, PT, RU)
- 10 leads patient cable
- 10 disposable ECG sensor
- 1 pouch for hanging recorder
- 1 USB cable for data downloads
- Instruction Manual (GB, IT)

## CONTEC 8000 WIRELESS ECG WORKSTATION - 12 CHANNELS

**33316 CONTEC 8000 WIRELESS ECG WORKSTATION**

Compact and portable device with an advanced ECG analysis algorithm which ensures reliable detection of arrhythmia. High sampling frequency (1000Hz) ensures correct waveform, high resolution display and printout. It includes wireless transmission of data to a PC in order to analyse, manage and save patients' reports. It acquires multiple functions including: 12-lead ECG collection, frequency cardiogram, high frequency ECG, QT internal dispersion analysis, Heart rate variability analysis, Pacing ECG analysis, Myocardium ischemia analysis, Heart rate turbulence analysis, Vectorcardiogram, Timed Vectorcardiogram and Ventricular late potential analysis. Built-in rechargeable lithium battery, continuous working for more than 7 h.

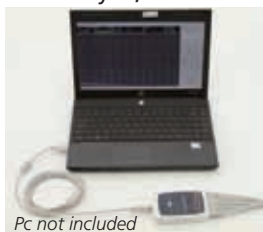

PC not included



33316



CE 0123

**33317 ECG CABLE - spare**

**TECHNICAL SPECIFICATIONS**

Lead:	standard 12-lead		
Input mode:	floating and defibrillation protection		
CMRR:	> 60dB, >100dB (add filter)		
Time constant:	≥ 3.2s		
Patient leak current:	< 10 µA		
Calibration voltage:	1mV		
Sampling:	frequency: up to 1000Hz	Accuracy:	up to 24-bit
Input circuit current:	≤ 50nA	Input impedance:	≥ 50MΩ
Noise level:	≤ 15µVp-p		
Frequency response:	0.05-150 Hz (-3 ~ + 0.4dB)	Polarizing voltage:	± 500mV
Polarizing voltage:	± 500mV		
Printing format:	A4, B5		
Report format:	BMP, PNG, PDF, JPG		
Operating system:	Windows 2000 / XP / Vista / 7 / 10 / 11		

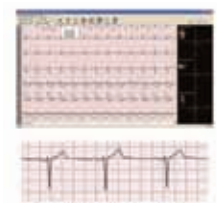

**STANDARD ACCESSORIES**

- 1 ECG lead cable
- 2 Extension cables (to electrode)
- 1 CD software
- 1 ECG workstation installation user manual: GB, IT
- 6 Chest electrodes
- 4 Limb electrode clamp
- 2 Lead cable clamps

Size: 100x45x15 mm  
Weight: about 60g



## PM10 PALM ECG WITH SOFTWARE AND BLUETOOTH

• **33246 PM10 PALM ECG - with software and Bluetooth**  
PM10 is a homecare device to check ECG parameters. It can be used as a reference for patient to take further medical treatment and for doctor to diagnose. It can help to early prevent from cardiovascular diseases and reduce risks. Intelligent design, remote health management through mobile application; it can automatically start measurement, store ECG, upload data, download health results. Suitable for patients with chronic diseases, especially coronary heart disease, diabetes, hypertension, myocarditis, obesity, chest pain, palpitations and dyspnea.



### 4 MEASUREMENT MODES



Features:  
- 1.77" colour TFT-LCD  
- quick ECG test with a simple touch. User friendly  
- accurate conclusion can be obtained immediately after measuring  
- continuously record for up to 500 cases with built-in rechargeable lithium battery in full charge  
- Bluetooth data transmission to free PHMS App  
- ECG data can be saved to cloud Platform permanently, easy to check and analyze  
- historical data can be printed at any time, easy to diagnose  
Supplied with a carrying bag, a multilingual manual (GB, FR, IT, ES, DE, PT) and a CD software to visualize data on PC

## CARDIO-B SINGLE CHANNEL PALM ECG



Multilingual manual and box (GB, FR, IT, ES).

**4 measurement modes: palm, leg, chest or lead wire traditional measurement.** Main features:

- small, portable and easy to use
  - 30 second ECG waveform and measurement results
  - 1200 ECG waveform can be saved
  - 10 hours ECG continuous measurement data storage
  - analysis and report of 17 types of ECG waveform
  - USB 2.0 interface with optional data cable and ECG software
  - traditional measurement with optional ECG cable
- CARDIO B with Bluetooth module for wireless data transmission.** Allows to download data on your smartphone or tablet, compatible with Android.
- **33249 ECG VIEWER SOFTWARE + US B 2.0 CABLE** for 33261 since SN: XXS02JL01044 - Jan 2014
  - **33248 ECG 3 PIN LEAD CABLE - 3 LEADS - optional** for 33261 since SN: XXS02HL01709 - 2012 and for 33259
  - **33264 OLD ECG BANANA LEAD CABLE - 3 LEADS - optional**

### TECHNICAL SPECIFICATIONS

ECG bandwidth:	1 Hz - 40 Hz
Heart rate measuring range:	30 - 240 bpm ± 2 bpm
LCD back light display:	240x160 dot matrix
Display size:	57.6x40 mm
Power:	2xAAA batteries
Dimensions - Weight:	125x70x21.5 mm - 106 g

• **33261 CARDIO-B PALM ECG - COLOUR DISPLAY**  
• **33259 CARDIO-B BLUETOOTH PALM ECG+VIEWER SOFTWARE**  
Designed for general practitioners or for domestic users who suffer from cardiovascular diseases such as hypertension, coronary disorders, giving the possibility of a daily ECG test. Records can be saved and used for clinical applications.

## CARDIO-C 3 CHANNEL POCKET ECG

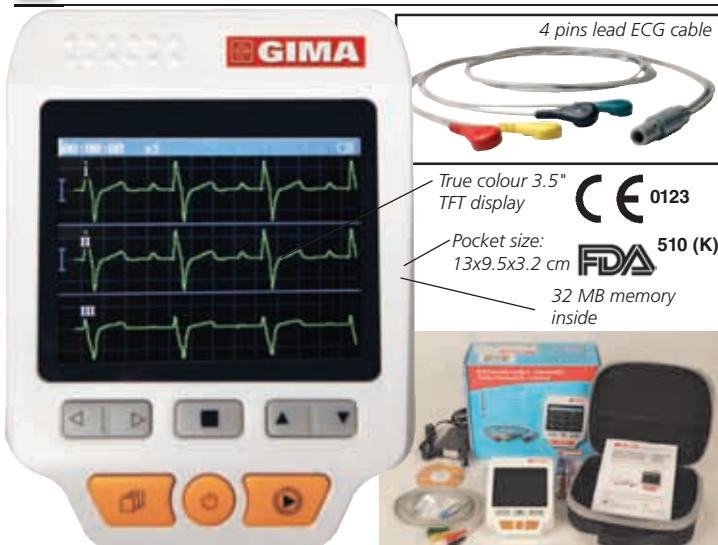

4 pins lead ECG cable

True colour 3.5" TFT display

Pocket size: 13x9.5x3.2 cm

32 MB memory inside

• **33245 CARDIO-C POCKET ECG 3 channel**

- small size, light-weight and easy to carry
  - one-key measurement
  - clear ECG waveform and interpretation of results on colour dot-matrix TFT 3.5" screen
  - up to 19 types of measurement results
  - high capacity built-in memory: 24 hours records storage and review for single channel waveform and 8 hours record storage and review for 3-channel waveforms
  - quick measurement: **by built-in metal electrodes**, on palm, chest or leg or **by external lead wires** (needs optional limb and chest electrodes)
  - data management to review or delete data records locally or to upload to PC
- Supplied with ECG viewer software, USB cable, power transformer, ECG 4 pins lead wire, 25 disposable electrodes, manual (GB, FR, IT, ES, DE, PT).
- **33364 SET OF 4 LIMB CLAMP ELECTRODES (4 COLOURS) - adult**
  - **33327 DISPOSABLE TNT ELECTRODES Ø 55 mm**

### TECHNICAL SPECIFICATIONS

Heart rate measuring range:	30 bpm ~ 240 bpm
Heart rate measuring accuracy:	± 2 bpm or ±2% whichever is greater
ECG bandwidth:	0.5 Hz ~ 40 Hz
Display scale:	5.0 mm/mV ±10%
Common-mode rejection ratio (CMRR):	≥ 60 dB
Waveform sweeping speed:	20 mm/s ±10%
Input impedance:	≥ 5 MΩ
Power:	4 AA alkaline batteries
Supply voltage range:	4.4 ~ 6 VDC
Max average working current:	≤ 160 mA
Auto power-off:	can be adjustable between 1-5 mins
Low battery indication:	4.4 VDC ±0.2 VDC

### Methods of ECG measurements: direct or with lead wires

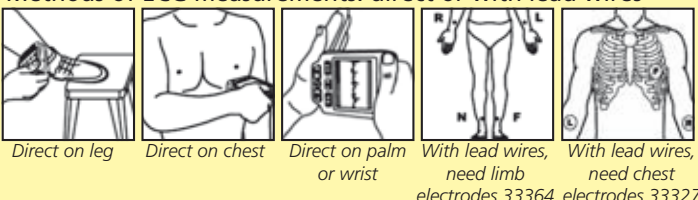



## D-HEART 8-12 CHANNEL PORTABLE ECG FOR SMARTPHONE OR TABLET

### • 33247 D-HEART 8-12 CHANNEL ECG

D-Heart is an 8 or 12 leads smartphone/tablet ECG that enables the acquisition of high quality 12 second ECGs in any place and condition.

- designed for patients, no medical background needed and health professionals
  - as clinically reliable as a hospital electrocardiograph
  - certified system to get a perfect ECG
  - easy to share with your cardiologist
  - telecardiology service available 24 hours / 7 days with subscription
- Supplied with lanyard, 60 disposable electrodes, electrode cables, soft case with incorporated wireless charger and multilingual user manual (GB, FR, IT, ES, PT, DE, GR, RU, TR, JP, CN, TH, Arabic).



#### Four easy steps

- 1- Connect the device with bluetooth
- 2- Place D-Heart on your chest
- 3- The App will guide you to make the ECG
- 4- Get immediate feedback from a cardiologist

Free D-Heart App required (GB, FR, IT, ES, PT, DE, GR)



See Apple and Android compatibility on [www.gimaitaly.com](http://www.gimaitaly.com)

#### TECHNICAL SPECIFICATIONS

Channels/leads:	8 for patient use, 12 for health professional use
A/D resolution:	12 bit
Measurement range:	> ±5 mV
Frequency response:	0.05 Hz ~ 150 Hz (-3 db)
Recording velocity:	25 mm/s (std) / 50 mm/s
Acquisition length:	from 12 s to 60 s (8 channels) 12 s (12 channels)
Filters:	AC 50/60 Hz (digital) Muscular 25/40 Hz (digital)
Recording frequency:	Acquisition 640 Hz / ch Transmission 640 at 4 intervals on average (160 Hz / ch)



## CARDIOPOCKET ECG - 3 CHANNELS

### • 33232 CARDIOPOCKET ECG 3 CHANNELS - with software

12-lead ECG printing ECG waveform with thermal printing system, measuring and diagnosing ECG waveform parameters automatically.

- full-automatic analysis function: auto-analysis and auto diagnosis for routine ECG parameters. It provides measurement results and auto diagnosis conclusion for HR, P-R interval, P Duration, QRS Duration, Q-T interval, Q-tc, P Axis, QRS Axis, T Axis, R(V5), S(V1), R(V5)+ S(V1)
- 2.83" colour LCD screen (resolution 320x240) that operates both with touch screen and keys
- high resolution thermal array output system 8 dots/mm (vertical)
- built-in rechargeable lithium detachable battery can continuously work for 4 hours, print up to 90 minutes and 150 ECG
- store up to 100 cases in a SD card
- high-accurate digital filter eliminates baseline drift and distortion to ECG waveform
- ECG-Sync software to form a ECG workstation

- 32963 THERMAL PAPER 50 mm x 20 m - box of 20 rolls
- 33233 RECHARGEABLE Li-Ion BATTERY

### • 33328 10 LEADS ECG CABLE - spare



#### TECHNICAL SPECIFICATIONS

Power:	AC: 100-240 V, 50/60 Hz - DC 12V rechargeable lithium battery 2,000 mAh
Noise level:	≤15 µVp-p CMRR: >60 dB, > 100 dB (add filter)
EMG filter:	25/35 Hz Time constant: ≥3.2 s
Frequency response:	0.05-150 Hz (-3 dB - 0.4 dB)
Patient leakage current:	<10 µA
Recording paper:	50 mm x 20 m, high speed thermal paper
Paper speed:	6.25, 12.5, 25, 50 mm/s ±5%
Safety standard:	IEC class I, type CF defibrillation-proof applied part
Input mode:	floating and defibrillation protection
Input circuit current:	≤0.1 µA Input impedance: ≥50 M Ω

#### STANDARD ACCESSORIES

- Patient cable
- 1 roll of paper
- 1 rechargeable lithium battery
- 4 limb electrodes
- 6 chest limb electrodes
- 1 adapter 12 V
- 1 user manual (GB, IT, FR, ES)
- 1 CD software (GB, FR, IT, ES, DE, TR) and cable for connection to PC



## DuoEK™ HANDHELD AND WEARABLE ECG MONITOR

### • 33239 DuoEK™ HANDHELD & WEARABLE ECG MONITOR

Handheld and wearable ECG monitor for instant ECG analysis anytime, anywhere. Compact and easy to carry, it can be worn on the belt for continuous real-time monitoring up to 15 minutes while working or walking.

4 measurement leads: lead I, lead II, chest leads. It can help to early detect potential problems as arrhythmia, heart pause, atrial fibrillation (Afib), tachycardia and bradycardia, premature atrial contractions (PACs).

Free ViHealth App on iOS and Android

Automatically upload data and share PDF report.

Supplied with charger, chest belt and multilingual manual: GB, FR, IT, ES, DE. Medical Device Class IIA

#### TECHNICAL SPECIFICATIONS

ECG length:	30 seconds to 15 minutes
Heart rate range:	30 to 250 bpm
Battery:	rechargeable lithium polymer battery
Battery working time:	> 500 checks
Charging time:	2-3 hours
Connection:	micro-USB connector
Wireless:	Bluetooth 4.0 BLE
Built-in memory:	up to 15 minutes
App storage:	unlimited
Size - weight:	91.4x33x7.6 cm - 18 g

#### 4 MEASUREMENT MODES

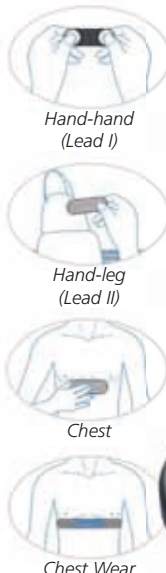

Phone not included



33239



# DIGITAL SINGLE, 3 OR 3/6 CHANNEL ECG

- **33220 SINGLE CHANNEL ECG 100G**
  - large LCD display waveform and data
  - high-resolution thermal printing array system
  - frequency response is as high as 150 Hz
  - capable of printing continuously on channel trace and annotations including lead mark and parameter such as sensitivity, paper speed and filter operation status
  - high resolution digital filter inhibits baseline drift without affecting ECG waveform
  - floating input circuit meets IEC safety standard
  - rechargeable battery supporting more than 50 patient examinations
  - internal software: GB, FR, IT, ES, DE, TR
  - manual: GB, FR, IT, ES
- **33225 RECHARGEABLE BATTERY - spare**
- **32968 PAPER ROLL 50 mm x 20 m - box of 20**
- **33328 ECG CABLE - 10 leads - spare**



**CONTEC™**

33220

USB connection allows real-time transmission to PC, remote data analysis and diagnosis, management and printing through the PC

- **33221 3 CHANNEL ECG 300G - monitor up to 12 channels**
  - 3.5" TFT colour LCD screen
  - 12 leads simultaneous display
  - thermal printing system
  - AC and DC power supply
  - high capacity built-in lithium rechargeable battery
  - battery power supports up to 150 ECG continuous records
  - built-in Database
  - built-in memory can store more than 1000 cases
  - digital signal processor for filter
  - auto-measurement, auto-analysis, auto-interpretations
  - ECG-Sync software, USB connection to PC
  - internal software: GB, FR, IT, ES, DE, TR, PL, PT, SI, BG, YU, RU, KZ, CN
  - PC software ECG Synchronous: GB, FR, IT, ES, PL, SI, TR, RO
  - manual: GB, FR, IT, ES.
- **33226 RECHARGEABLE BATTERY - spare**
- **32969 PAPER ROLL 80 mm x 20 m - box of 10**
- **33328 ECG CABLE - 10 leads - spare**



33221

USB connection allows real-time transmission to PC, remote data analysis and diagnosis, management and printing through the PC

- **33222 6 CHANNEL ECG 600G - monitor up to 12 channels**
  - 7" TFT, colour LCD touch screen
  - 12 leads simultaneous display
  - digital isolation technology and signal processing solution, digital filter
  - patient management, name, age and id, detail analysis report
  - built-in lithium rechargeable battery
  - thermal printing system provides more than 10 printing modes
  - can print 90 minutes and print out 150 ECG continually
  - ECG-Sync software, USB connection to PC and built-in memory can store more than 1000 cases
  - auto-measurement, auto-analysis and auto-interpretation
  - internal software: GB, FR, IT, ES, DE, TR, PL, PT, SI, RU, KZ, CN
  - PC software ECG Synchronous: GB, FR, IT, ES, PL, SI, TR, RO
  - manual: GB, FR, IT, ES.
- **33226 RECHARGEABLE BATTERY - spare**
- **32970 PAPER ROLL 110 mm x 20 m - box of 10**
- **33328 ECG CABLE - 10 leads - spare**



33222

**TECHNICAL SPECIFICATIONS**

		ECG 100G	ECG 300G	ECG 600G
ECG instrument Input	Safety Type	Class I, type CF applied part, which has defibrillation-proof applied part		
	Lead	Standard 12 leads		
	Input way	Floating and defibrillation protection		
	Patient leak current	<10µA		
	Sampling rate	800 Hz	1,000 Hz	1,000 Hz
	A/D conversion	12bit		
	Frequency response	0.05Hz~150Hz (-3dB, + 0.4dB)		
	Time constant	≥ 3.2s		
	CMRR	>60dB, >100dB(Add filter)		
	Enduring polarization voltage	±500mV		
Dispose Wave Data	Noise level	<15µVp-p		
	EMG interference filter	35Hz (-3dB)	25Hz/35Hz (-3dB)	
Waveform output	AC filter	50Hz/60Hz (-20dB)		
	Recording way	Thermal printing system	Thermal printing system (32spots/mm)	
	Recording paper	50mm(W)×20m(L)	80mm(W)×20m(L)	110mm(W)×20m(L)
	Sensitivity	5, 10, 20mm/mV	2.5, 5, 10, 20, 40 mm/mV	
	Paper speed	Auto-record: auto leads changing	Auto-record: 25mm/s, 50mm/s	
Power supply	AC	110-220V, 50/60 Hz		
	DC - Lithium battery	7.4V, 2000 mAh	7.4V, 3500 mAh	
Fuse		2 pcs φ5x20mm AC time lag; T250mA/250V(Power Supply:220V)		
Form	Size	315 x 215 x 77 mm		
	Net Weight	1.5 kg	1.6 kg	1.7 kg



**STANDARD ACCESSORIES**

- ECG cable - 1 set
- Limb electrode clamp - 1 set
- chest electrodes - 1 set
- Ground wire
- Power connection
- Paper roll
- USB connection and PC software (only 33221 and 33222)

- **33228 CARRYING BAG 39x29x14 cm**



# EDAN SINGLE OR THREE CHANNEL ECG

33330



33333

Single and three channel with 12 channel display



INTERPRETATION

COLOUR DISPLAY

### EDAN PORTABLE ECG - 1 and 3 channel

- foldable LCD screen, vivid waveform display
- built-in high resolution thermal printer
- built-in rechargeable Li-ion battery, AC/DC supply
- complete digital filter, avoid baseline drift, AC, EMG interfere
- automatic baseline adjustment
- auto/manual operation selectable
- lead-off detection and alarm

### SE-3 Three channel colour ECG also features

- interpretation tested by CSE/AHA/MIT database
- 12 Lead simultaneous acquisition
- automatic ECG parameters measurement and analysis
- auto, manual, rhythm off work mode
- support barcode scanner to simplify patient information input
- LAN/RS232/USB connection to PC
- 12 leads grid printing on normal A4 paper by external printer

### ECG Viewer Software: PC based ECG data management software

- compatible with Windows XP, WIN 7, Vista (32 bit, 64 bit)
- multi format reports - XML/SCP/DICOM/PDF/JPG/BMP/TIFF/PNG
- support bi-directional communication with ECG device

GIMA code	EDAN ECG AND ACCESSORIES
33330	Edan SE-1 Single Channel ECG
33333	Edan SE-3 colour Three Channel ECG - interpretative
33336	ECG-Viewer Software (GB, FR, IT, DE, PL, RU, ES, TU) for 33333
32963	Thermal paper - roll 50mm x 25m for 33330 and 33305
32964	Thermal paper - roll 80mm x 25m for 33332/3 and 33306
33328	ECG cable - spare
33318	Rechargeable Lithium battery 2500 mAh - spare
27139	Transport bag - see page 79

### TECHNICAL SPECIFICATIONS

	33330	33333
Lead:	One lead	Standard 12 leads
Acquisition mode:	One lead	12 leads simultaneously
Sensitivity:	2.5, 5, 10, 20 mm/mV	2.5, 5, 10, 20 mm/mV
Input impedance:	> 50 MΩ (10 Hz)	> 50 MΩ (10 Hz)
Filter:	EMG Filter 35 Hz (-3 dB) AC/DFT Filter 50 Hz/60Hz (-20 dB)	EMG Filter 25/35/45 Hz off DFT Filter 0.05/0.15/0.25/0.32/0.5/0.67 Hz Low pass filter 150/100/75 Hz AC Filter on/off
Recording mode:	Auto/Manual	Auto/Manual/Rhythm/USB/PT
Rhythm lead:	Any lead selectable	Any lead selectable
Safety standard:	IEC I/CF	IEC I/CF
Power supply:	AC: 100-115 V, 220-240 V, 50/60 Hz	AC: 100-115 V, 220-240 V, 50/60 Hz
	Rechargeable Li-ion battery: voltage 14.8 V	Rechargeable Li-ion battery: voltage 14.8 V
	More than 6.5 hours continuous operation with battery supply	More than 6.5 hours continuous operation with battery supply
Data storage:	-	500 ECG's
Thermal paper:	50 mm x 30 m	rolled 80 mm x 20 m folded 80x70 mm x 200 pages
Paper speed:	25 mm/s, 50 mm/s (± 3%)	5mm/s, 6.25 mms 10 mm/s, 12.5 mm/s, 25 mm/s, 50 mm/s (± 3%)
Dimension:	300x260x75 mm	300x260x75 mm
Weight:	2.3 kg (with battery)	2.5 kg (without battery)
Display:	192x64 pixel LCD	320x240 pixels LCD (colour screen)
Selectable display language:	GB, IT, FR, ES, PL, RU, TR, UA	GB, IT, FR, ES, RU, PL, CZ, RO, DE, TR, HR, UA
Interface:	RS 232	Ethernet, RS232, USB
Barcode scanner support:	-	yes
Report formats:	-	PDF, Dicom, SCP, XML

### STANDARD ACCESSORIES

Patient cable	1 roll of paper	4 limb electrodes
1 bottle of gel	Rechargeable battery	6 chest limb electrodes
Manual: GB, IT. On request: FR, ES, PT, TR (SE-1 and SE-3), DE, RU (SE-3 only)		

# MINDRAY BENEHEART R3 ELECTROCARDIOGRAPH

### • 33301 MINDRAY BENEHEART R3 ELECTROCARDIOGRAPH 3 channels

Lightweight portable cardiograph for resting ECG diagnosis.

### Reliable analysis - Glasgow algorithm

Utilizes the University of Glasgow ECG analysis algorithm, one of the world-leading resting ECG interpretations.

### Great Portability - only 1.2 kg

Weighs only 1.2 kg with battery, easy to carry.

### 5" clear colour display

Offers the highest resolution in industry, enabling clinicians to observe real-time waveforms accurately.

### Convenient operations

ECG recording is automatically unfolded on the writing pad at the top of the unit for notes or signature.

### Unique recorder - Z-folded or rolling paper

Compatible with both rolling paper and Z-fold paper.

Easily switchable without dismantling the pressure lever.

### • 33014 ROLL THERMAL PAPER - 80 mm x 20 m - box of 10

### • 33016 Z-FOLD THERMAL PAPER - 80x70 mm x 200 sheet - box of 25

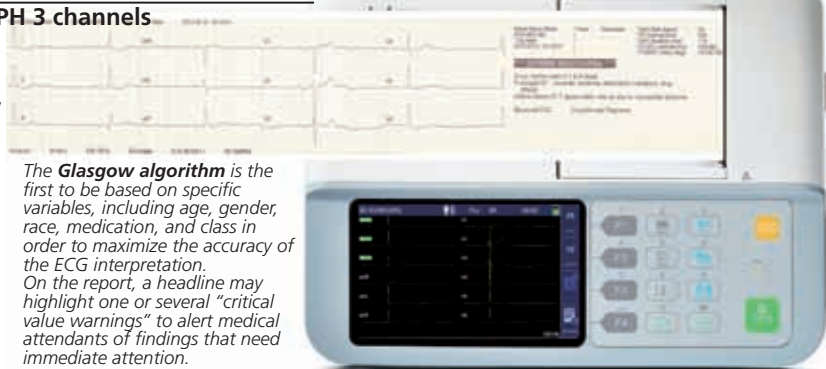

The **Glasgow algorithm** is the first to be based on specific variables, including age, gender, race, medication, and class in order to maximize the accuracy of the ECG interpretation. On the report, a headline may highlight one or several "critical value warnings" to alert medical attendants of findings that need immediate attention.

### STANDARD ACCESSORIES

Cable with banana plugs, IEC	1 roll paper
Limb clamp set of 4	Rechargeable battery
Chest bulb set of 6	User manual in: GB, FR, DE, HU, IT, PL, ES, TR
Glasgow algorithm (available in 13 languages as internal software)	

TECHNICAL SPECIFICATIONS		mindray
Power	AC power: 100 to 240 VAC ± 10% 60 VA Battery-type: rechargeable Lithium ion battery 11.1 V typical, 2,500 mAh - capacity: 6 hours of continuous operation without recording or 500 ECGs in 2.5 x 4 format at 25 mm/s and 10 mm/mV - charge time: 3.5 hours with power off	Thermal printer: Dot array/Width 80 mm/speed 5, 12.5, 25, 50 mm/s
Processing	ECG analysis: 500 samples/second (sps) Digital: 1,000 samples/second/channel Pacer detection: 16,000 samples/second/channel Acquisition mode: Pre-acquisition or post-acquisition provide 10 seconds of instantaneous ECG acquisition	Software Resting ECG mode: Records and prints 12-lead resting ECG with 10-second duration Patient information: Patient ID, secondary ID, age, date of birth, gender, race, medication class and V3 electrode placement Internal storage: 800 ECGs in internal memory ECG Storage format: PDF and Mindray storage format internal software: GB, FR, IT, ES, DE, PL, PT, TR, RU, HU, RO, CZ, CN Report formats Size/Weight: Thermal printer/PDF/A4/letter 250x194xh 56 mm/1.2 kg including battery
ECG amplifier:	DC-coupled	
Input impedance:	50 MD at 10 Hz, defib protected	
Patient leakage:	< 10 µA	
Heart rate meter:	30 to 300 BPM ± 10% or ± 5 BPM, whichever is greater	
Sensitivity/gain:	5, 10, 20 mm/mV, Auto	
Colour display	TFT LCD with LED graphics backlit 800x400	
Resolution:	800x400	
Display data:	Patient ID, gender, age, heart rate, clock, battery power indicator, waveforms, lead labels, speed, gain, filter settings, warning messages, information messages, network status and USB	

# MULTI CHANNEL ECG WITH INTERPRETATION ON PAPER

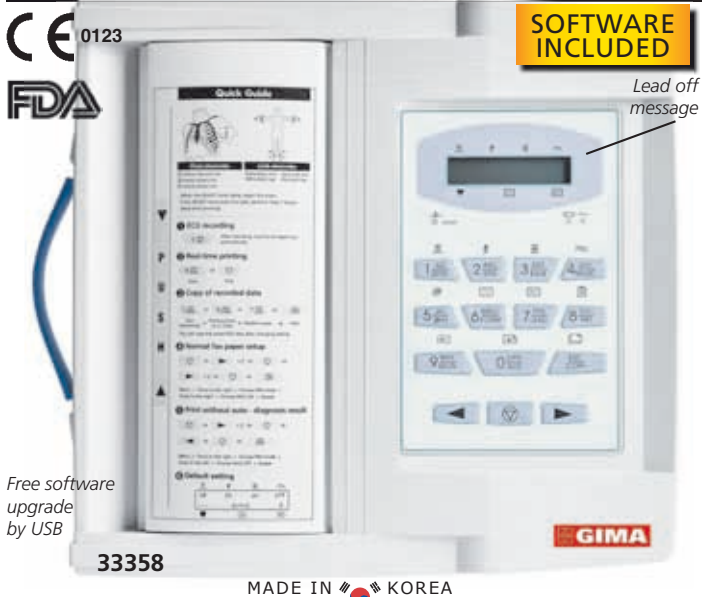

Free software upgrade by USB

33358

MADE IN KOREA

- **33358 NEW CARDIOGIMA 12 ECG - 3-6-12 channel**  
Cost effective 12 channel resting ECG recorder without performance compromise. The simultaneous record of 12 channels has a high diagnostic value - all the 12 channels are shown at the same time.
- one touch operation for analyzing, storing and printing result
- 12 leads simultaneous 10-second resting ECG
- over 130 kinds of interpretation results based on Minnesota code Internal software+print in GB, FR, IT, ES, DE, RU, TR, PL, PT, RO, KR.
- wide paper printing (A4 size thermal paper, fax paper is OK)
- combined output of all relevant curves, patient data, date, time and instrument settings
- **PC Connections**  
Connection to PC with LAN to submit recorded ECG signal to other specialist for evaluation (only a modem is needed)
- **ECG filing system**  
A fully configured PC-based software enables to record, print, change the settings of ECG's and save them in JPEG, PDF, XML format, which ensure compatibility with most EMR package.
- **rechargeable battery (optional)** with 6 hour capacity

TECHNICAL SPECIFICATIONS	
ECG Leads:	3-6-12 channel illustration of ECG signals in continuous recording or 10 sec. recording with interpretation.
Size - weight:	200x300x97.5 mm - approx 3 kg
Recording channel:	3, 6, 12 channel and 1 channel (60 sec.)
Sensitivity:	5, 10, 20, auto (I-aVF: 10, W1-V6: 5) mm/mV
Printing speed:	12,5; 25; 50 mm/s
Filters:	AC (50/60 Hz, -20 dB or better), Muscle (25-35 Hz, -3 dB or better) Base line drift (off 0.05, 0.1, 0.2 Hz - 3 dB or better) Low pass filter (off, 40 Hz, 100 Hz, 150 Hz)
Sampling rate:	analysis 500 samples/sec, digital 8,000 samples/sec
Display:	2x16 character LCD display
LCD display:	Sensitivity, speed filter status, HR, Printing form, rhythm lead
LED indicator:	Signal quality, power source, battery
Keyboard:	Membrane keyboard, alphanumeric and symbol available
Patient data:	ID, name, age, sex, height, weight
Basic measurement:	Heart rate, PR, QRS, QT/QTc, P-R-T axis
Recorder:	Thermal print head, thermal paper roll Report papers: A4: 215X297 mm (8.5"x11.7") Letter: 215x280 mm (8.5"x11")
Resolution:	vertical: 8 dots/mm, horizontal: 16 dots/mm
Electrical:	Internal noise: 20 µV (p-p) max input impedance: >50MΩ Input voltage range: ± 5 mV CMRR: greater than 105 dB DC offset voltage: ≥ ± 400mV Patient leakage current: < 10µA Frequency response 0,05-150 Hz within -3 dB Isolated, defibrillation and ESU protected
Power supply:	AC or rechargeable lithium-ion 11.1 V 2600 mA battery (optional) Power requirement: 100-240 Vac, 50/60 Hz, 1.0-0.5 A Power consumption: 60 W max
Battery capacity:	6 hour of normal use (approx. 200 automatic ECG printouts)
Communication:	LAN
Safety:	Class I, Type CF
Conformity:	CE, FDA, KFDA, CFDA, NCC

STANDARD ACCESSORIES	
1 PC software	6 Chest electrodes, suction for adult
1 LAN cable	1 Operation manual (GB/IT)
1 Patient cable - 10 leads	
4 ECG clip-on electrodes	
1 Power cable	
1 ECG gel tube (250 ml)	
1 Recording paper roll	

CARDIOGIMA 12 ACCESSORIES		
<b>29536</b>	Rechargeable lithium battery for 33358 - optional	33358 + 29519
<b>29534</b>	Rechargeable battery for old 33354/33355	
<b>32950</b>	Thermal paper A4 - for 33354-5-7-8 - box of 5	
<b>33328</b>	ECG cable for 33354-5-7-8	
<b>29519</b>	Trolley for 33354-5-7-8	

# DIGITAL 12 CHANNEL COLOUR ECG

Supplied with standard USB configuration



33224

- **33224 12 CHANNEL ECG 1200G**
- 8" TFT display, 800x600 dots high resolution colour LED backlight
- simultaneous 12 leads acquisition and display
- digital signal technique, AC filter, baseline filter, EMG filter
- auto-analysis and auto-interpretation
- Multi-mode display and printing, such as 12, 6+1 (rhythm), 6, rhythm 12, rhythm 10, rhythm 8, rhythm 6. Manual, Freeze etc
- 0.5 built-in lithium rechargeable battery
- 2 USB and LAN Socket for uploading data to PC
- built-in flash memory. Stores more than 1,000 files
- Multilingual internal software: GB, FR, IT, ES, PT, PL, SI, TR, RU, KZ, CN.
- **33227 RECHARGEABLE BATTERY - spare**
- **32967 PAPER ROLL 210 mm x 30 m**
- **33328 ECG CABLE - 10 leads - spare**



USB and LAN socket

TECHNICAL SPECIFICATIONS	
Input way	Floating and defibrillation protection
Lead	Standard 12 leads
Patient leak current	< 10 µA
Input impedance	≥ 50 MΩ
Frequency response	0.05 - 150 Hz (-3 - + 0,4 dB)
Time constant	≥ 3,2 s
CMRR	>60 dB, > 100 dB (adding filter)
EMG interference filter	25/35 Hz (-3 dB)
Thermal paper	210 mm x 30 m high-speed
Paper speed	Auto and rhythm record: 25, 50 mm/s, ±5% Manual record: 5, 6,25, 10, 12,5, 25, 50 mm/s, ±5%
Sensitivity selections	2,5, 5, 10, 20, 40 mm/mV, ±5%. Standard sensitivity is 10 mm/mV ±0.2 mm/mV.
Auto record	Record setup according to auto record format and mode, automatically changing leads, measuring and analyzing.
Rhythm record	Record setup according to rhythm record format and mode, automatically measuring and analyzing.
Manual record	Record setup according to manual record format, manually changing leads.
Measurement parameters	HR, P-R interval, P Duration, QRS Duration, T Duration, Q-T interval, Q-Tc, P Axis, QRS Axis, T Axis, R(V5), S(V1), R(V5)+S(V1)
Product safety type	Class I CF defibrillation and pacing protection
Size	334x320x85 mm
Power	AC: 100-240 V, 50/60 Hz DC: 14.8 V, 3700mAh rechargeable lithium battery

STANDARD ACCESSORIES	
1 ECG cable	1 ground wire
1 set limb electrode clamp	1 paper roll
1 set chest electrodes	Power connection
USB connection	
Rechargeable battery	
Software (same languages as internal software)	
Manual: GB, IT	

## NEO ECG - TABLET ECG

54230



- 54230 NEO ECG S120 - ECG TABLET
  - 54231 NEO ECG T180 - ECG TABLET with printer
- Light and portable ECG tablets for acquisition and displaying of 9/12 lead waveform, as well as heart rate detection. 7" (54230) or 10.1" (54231) high resolution colour touch screen, easy to operate. It can store, preview, review, edit and upload patient data through wireless transmission of ECG data via WiFi and mobile networks. Patient data can be exported to USB flash disk via USB connector.
- Glasgow algorithm
  - 4 sampling modes: pre-sampling, real-time sampling, periodic sampling, and trigger sampling
  - automatic pacing detection and marking
  - auto RR analysis, HRV, medicine test, ECG event mode
  - files in multiple formats: Carewell ECG, PDF, BMP, HL7, DICOM, SCP
  - freezing of ECG waveform on the screen
  - virtual keyboard and barcode scanning to insert patient information

ECG leads:	9,12 synchronous acquisition
A/D resolution:	24 bits
Heart rate range:	30 bpm-300bpm ± 1
Sensitivity:	auto, 2.5, 5, 10, 20, 40 mm/mV, less than ± 5% error
Printing speed:	5, 6.25, 10, 12.5, 25, 50 mm/s, less than ± 3% error
Sampling rate:	32000 samples/sec
Filters:	AC (50-60 Hz, off), EMG (25-35-45 Hz off) ADS (0.01-0.05-0.32-0.67 Hz) Low pass filter (75-100-150-300 Hz off)
Frequency response:	0.01-350 Hz (+ 0.4-3.0 db)
Minimum detectable signal:	20 µVp-p

### TECHNICAL SPECIFICATIONS

Electrical:	Internal noise: ≤ 12.5 µV
	Input impedance: ≥ 100 MΩ (10 Hz)
	Input circuit current: ≤ 10 nA
	Calibration voltage: 1mV ± 2 %
	Depolarization voltage: ± 900 mV, ± 5 %
	Commode mode rejection: ≥ 140 dB (AC filter on) ≥ 120 dB (AC filter off)
Amplitude quantisation:	0.95 µV/LSB
Recovery time after discharge:	< 10 s
Display:	7" (54230) or 10.1" (54231) colour touch screen
Size - weight:	19.7x11.2x 2.6 cm - 0.8 kg (54230) 27.4x28.8x 11.1 cm - 2.5 kg (54231)



54231

WITH PRINTER

- built-in thermal printer (54231 only)
- external DC power supply and built-in rechargeable battery
- recorder charging port (54231 only)
- multilingual selectable software: GB, FR, IT, ES, PT, DE, GR, PL.

GIMA code	ACCESSORIES
54233	Rechargeable battery 5000 mAh for 54230, 54231 - spare
33328	ECG cable - spare
32950	Thermal paper 20mx216mm for 54231 - spare

### STANDARD ACCESSORIES

- 1 ECG cable (IEC, Ø 4 mm, banana connector)
- 6 pcs adult precordial suction electrodes (Ø 4 mm)
- 4 pcs adult limb clamp electrodes
- 1 thermal roll paper - 20mx216 mm (54231 only)
- 1 rechargeable lithium battery
- 1 power adapter
- Multilingual manual: GB, IT, on request FR, ES, PT, DE, GR, PL.

## 12 CHANNEL ECG WITH PC SOFTWARE

- 33219 12 CHANNEL ECG - 1212G - with software
- It can collect 12-lead ECG signal simultaneously and print ECG waveform with built-in thermal printing system. It features in recording and displaying ECG waveform in auto/manual mode; measuring, analyzing and diagnosing ECG waveform parameters automatically.
- 1280x800 dots, 10.1" high resolution colour LCD display
  - display of 3/6/12-lead ECG to observe abnormal heart rhythm
  - powered by AC/DC or built-in rechargeable lithium battery
  - up to 10-hour standby and continuous print over 3-hours
  - record up to 1,000 ECG waveforms
  - auto-measurement and auto-interpretation of routine ECG provide measurement results and auto-diagnosis conclusion
  - auto-diagnosis conclusion for HR, PR Interval, P Duration, QRS Duration, T Duration, QT/QTc Interval, P/QRS/T Axis, R(V5), S(V1), R(V5)+S(V1) amplitude
  - built-in large memory can store at least 4000 medical records,
  - functions of LAN, USB cable transmission. Automatically upload cases, download reports and print them
  - historical medical records can be exported to other electronic file formats (dat, pdf, xml, bmp, jpeg, png etc.)
- CD software in GB, FR, IT, ES, PL, RO, SI, TR.
- 33218 RECHARGEABLE BATTERY - spare
  - 32967 PAPER ROLL 210 mm x 30 m - spare
  - 33328 ECG CABLE - 10 leads - spare

33219

Size:  
34x32xh 8.6 cm  
Weight: 5 kg

CONTEC™

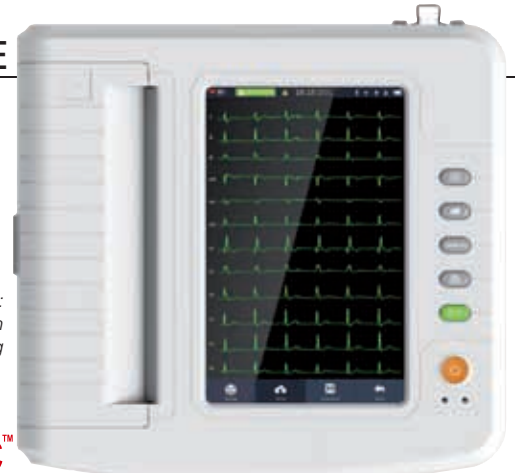

STANDARD ACCESSORIES		
1 lead cable	1 Power cord	User manual (GB, IT)
1 set limb electrodes	Thermal paper 210 mm x 20 m	1 Ground wire
1 set chest electrodes	Rechargeable battery	CD software

### TECHNICAL SPECIFICATIONS

Input way:	Floating and defibrillation protection	
Lead:	standard 12 leads	
Patient leakage current:	<10µA	Time constant: ≥3.2s
Input impedance:	≥2.5 MΩ	CMRR: >105 dB
Paper speed:	12.5 mm/s, 25 mm/s, 50 mm/s, ±5%	
Sensitivity selection:	5, 10, 20 mm/mV, accuracy is ±2%; standard sensitivity: 10 mm/mV ±0.2 mm/mV	
Auto record:	record setup according to auto record format and mode, automatically change leads, automatically measure and analyze	
Rhythm record:	record setup according to rhythm record format and mode, automatically measure and analyze	
Manual record:	record according to manual record format	
Product safety type:	Class I type CF defibrillation-proof function applied part	
Power supply:	rechargeable lithium battery, 14.8 V 5200 mAh	
Frequency:	100-240 V, 50/60 Hz, ≤150 VA	

# CARDIOLINE COLOUR TOUCH SCREEN 12 LEAD ECG

PORTABLE

MADE IN ITALY

A4 FULL FORMAT

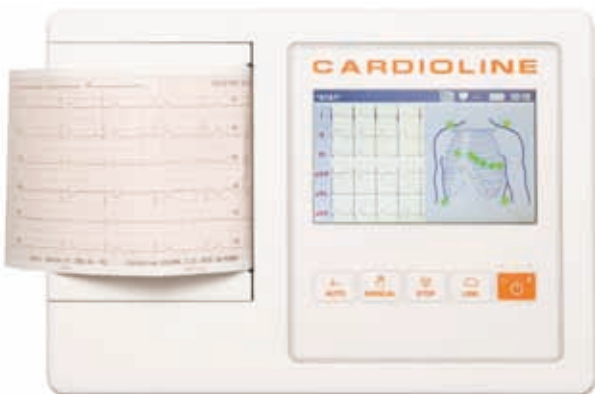

54200-1-2

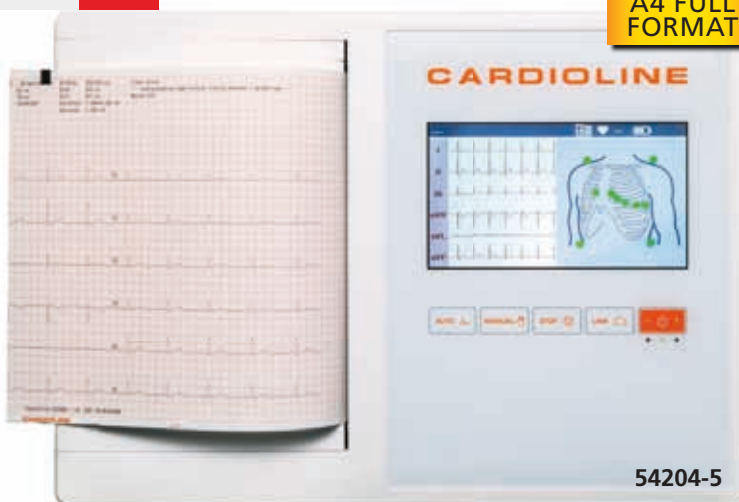

54204-5

- 54200 CARDIOLINE ECG 100L BASIC - 5" screen
- 54201 CARDIOLINE ECG 100L GLASGOW - 5" screen
- 54202 CARDIOLINE ECG 100L FULL (Glasgow + EasyApp) - 5" screen
- 54204 CARDIOLINE ECG 200L GLASGOW - 7" screen
- 54205 CARDIOLINE ECG 200L FULL (Glasgow + EasyApp) - 7" screen

The Cardioline ECG have been designed to provide simple and fast 12 lead resting ECG acquisition for the private practice. Particular attention has been dedicated to device usability using a brilliant 5" (54200-2) or 7" (54204-5) colour touch screen display, as well as dedicated keys for fast operation. User is guided through ECG acquisition step by step, from electrode placement, to quality checking, acquisition, printing and storage. Automatic, manual, Stat or rhythm ECGs can alternatively be acquired at the simple touch of a key. The new Rhythm ECG function allows for rhythm analysis of 3 minutes of ECG, including HR trending and Variability. ECG files can be stored on the device or exported, through USB connection to a PC or a memory stick.

### Support most printing formats

Standard or Cabrera 3, 3+1, 3+3, 6, 12 (12 only 54204-5) channels in automatic mode and 3, 6 or 12 printout channels in continuous mode, as well as printout of the rhythm strip.

### Multilingual switchable internal software in 16 languages

GB, FR, IT, ES, PT, DE, RO, RU, CZ, HR, BR, HU, NL, TR, RS, PL.

### STANDARD ACCESSORIES

Patient cable	2 rolls of paper (for 54200-2)
Battery	1 pack of 180 sheets (for 54204-5)
Power cable	Adaptor for snap connector 4 mm (box of 10)
Glasgow interpretation (54201-5)	Disposable tab electrodes (box of 100)
CD Manual (GB, FR, IT, ES, PT, DE, NL, CZ, HR, HU, PL, RO, RU)	

### TECHNICAL SPECIFICATIONS

<b>ECG acquisition</b>	
ECG channels:	12-lead (I, II, III, aVR-L-F, V1-6)
Patient cable:	Standard 15D, 10-wires
CMRR:	>100 dB
Input impedance:	100 MΩ
Sampling rate of the input stage:	32000 samples/second/channel
ECG resolution:	5µV/LSB; 500 s/s
Dynamic range:	± 325 mV
Bandwidth:	Performance equivalent to 0,05-150 Hz
Pacemaker detection:	Hardware detection coupled with convolution digital filtering
Filters:	Linear phase digital diagnostic high-pass filter (acc. to 60601-2-25 2nd ed.) 50/60 Hz AC interference adaptive digital filter Digital low pass filters at 25/40 Hz, for display and printing only
Defibrillation protection:	AAMI/IEC standards
Front-end performance:	ANSI/AAMI IEC 60601-2-25:2011
Acquisition mode:	Automatic (12-leads), Manual (3/6-leads only 54200-2), Manual (3/6/12-leads only 54204-5) Stat (12-leads), Rhythm (1/3-leads)
Configuration:	Standard or Cabrera
Lead fail detection:	Independent on all leads
Heart rate meter:	30-300 bpm
ECG measurements:	All leads, average, corrected; HR; Average RR; PR interval, QRS duration QT interval and QTc interval, with Hodges, Bazett and Fridericia's formula max R[V5] or [V6] and S[V1] Sokolow-Lyon index; P, R, T axis

### Glasgow algorithm for pediatric and adult interpretation (only 54201 - 54205)

The algorithm can diagnose any abnormality, usually recognizable through ECG: myocardial infarction, including AMI, ventricular hypertrophy, ST-T and common rhythm anomalies. Furthermore, the program detects conduction and QT interval prolongation malfunctions.

### ECG EasyApp to manage patient ECGs (included with 54202, 54205, optional for 54200-1, 54204)

Through this App, ECG acquisitions can be received in SCP format on PC (via USB) and printed. Patient data and automatic interpretations, provided by ECG, can be modified, including test results. The operator can also customize rhythm strips layout with specific commands (speed, gain, filter etc.).

### ECG EasyApp

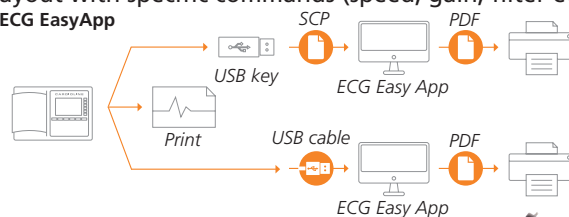

54212 + 54200

GIMA code	CARDIOLINE ACCESSORIES
54210	Cardioline ECG cable 12 leads - spare
54211	Battery for 54200-5 - spare
54212	Carrying bag ready for use for 54200-2
33052	Thermal paper 100 mm x 20 m (100 L) - box of 5
33055	Thermal paper 210x295 mm (200 L) - box of 180 sheets

<b>ECG interpretation:</b>	Glasgow Analysis Program for Adult, Pediatric, STEMI (only 54201-2-4-5)
<b>ECG storage:</b>	50 ECG
<b>Export format:</b>	SCP-PDF
<b>PC-ECG "Easy App":</b>	ECG Management application for PC (only 54202, 54205)
<b>Display</b>	
Type:	5" (54200-2) or 7" (54204-5) TFT backlit colour LCD with capacitive touch panel
Resolution:	800x480
Data:	3/6/12-leads real time
<b>Printer</b>	
Thermal printer head:	108 mm (54200-2) or 216 mm (54204-5)
Resolution:	8 dots/mm
<b>Physical characteristics</b>	
Device size/weight:	270x190x60 mm (54200-2) - 1.48 Kg 413x295x80 mm (54204-5) - 4.17 Kg
<b>Power</b>	
Power supply:	100-240V, 50/60 Hz
Degree of protection power supply:	IP20
Battery type:	NiMH
Battery duration:	more than 500 ECGs, more than 6 hours
Battery charging time:	4 hours to 85% full capacity
<b>Regulatory and safety</b>	
MDD 93/42/CEE Class IIa	
IEC 60601-1-2 (electromagnetic compatibility):	Group 1 - Class B
IEC 60601-1 (electrical safety)	
Protection against electric shock:	IP (internal power ME), Class I (on external AC/DC)
Protection against water:	IXP 0

# NEW CARDIO 7: 12 CHANNEL RESTING ECG WITH TOUCH SCREEN

**SOFTWARE BM5 PLUS**  
for data storage on PC



Long term ECG recording and automatic arrhythmia detection

Touch screen operation full alphanumeric keyboard support

USB function

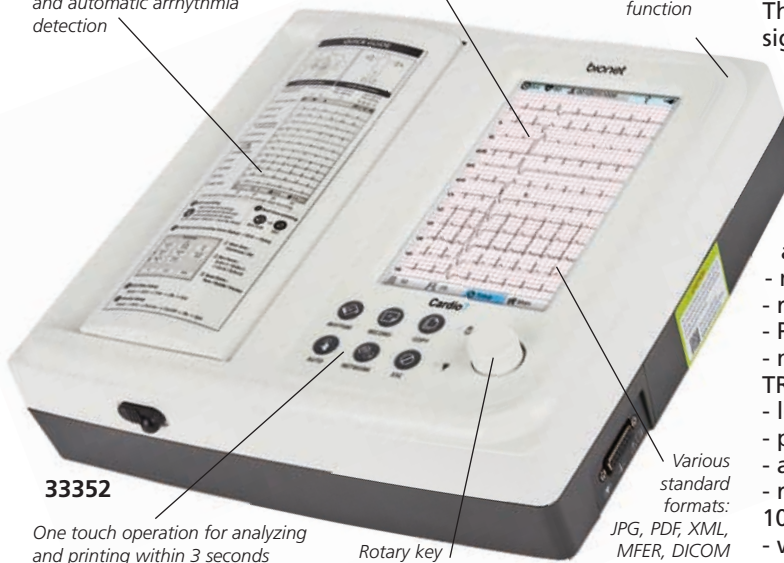

## • 33352 NEW ECG CARDIO 7: 12 CHANNEL ECG WITH TOUCH SCREEN

The new Cardio 7 is an electrocardiogram (ECG) device capable of measuring and recording 12 channels of cardiac signals in adult and pediatric patients.

The device enables operators to record and print cardiac signals, review them using various viewing modes, perform automatic detection of cardiac conditions.

It is also possible to manage the digital files by transferring the stored data to a networked PC. This equipment is protected against the effects of cardiac defibrillator discharge.

- over 120 kinds of interpretation results based on advanced Minnesota code, HRV (Hearth Rate Variability analysis)
- memory for up to 200 patients
- real-time preview monitor
- PC compatible through LAN or USB flash drive
- multilingual selectable software (GB, FR, IT, ES, DE, PT, PL, RO, TR, RU, KR)
- lead fault message
- pace maker detection
- automatic arrhythmia detection
- record rhythm from 1 channel for an extended time (1, 5 and 10 minutes) then print it on A4 or letter size printing paper
- wide and clear colour 7" TFT LCD (800x480)
- touch screen for easy operation
- full disclosure function

- 32950 THERMAL PAPER A4 - box of 5 rolls
- 29534 RECHARGEABLE Ni-MH 12 V BATTERY for old model 33357 (up to S.N. T7xxxxxxx) - optional
- 29536 RECHARGEABLE Li-Ion BATTERY for 33357 (since S.N. T8xxxxxxx) and 33352 - spare
- 29519 TROLLEY
- 33328 ECG CABLE

**33352**  
One touch operation for analyzing and printing within 3 seconds

Rotary key access to all menus

Various standard formats: JPG, PDF, XML, MFER, DICOM

### STANDARD ACCESSORIES

- Patient cable - 10 leads
- LAN cable
- 1 bottle of ECG gel (70 g)
- 1 power cord
- manual (GB, IT)
- 1 paper roll
- 4 limb electrodes
- 6 chest limb electrodes
- BM5 Plus (GB, IT)
- Rechargeable Li-ion battery



### TECHNICAL SPECIFICATIONS

ECG leads:	10 lead, 12 channel simultaneous ECG and acquisition	length:	A4 297 mm (11.7") letter 279 mm (11")
Dimension:	300x200xh 97.5 mm, approx. 3.5 kg	A4 report paper:	210x300 mm (8.5"x11")
Recording channel:	3 channels + 1 rhythm, 3 channels + 3 rhythm, 6 channels + 1 rhythm, 12 channels, 6 channels + st map 1 channel	Vertical:	8 dot/mm (0.125 mm pitch)
Gain:	2.5, 5, 10, 20, auto (I-aVF: 10, V1-V6: 5) mm/mV	Internal noise:	20 µV (p-p) max
Printing speed:	5, 12.5, 25, 50, 100 mm/s	Input impedance:	≥50 MΩ
Sampling rate:	Analysis - 500 s Digital - 8,000 s	Input voltage range:	≥ ±5 mV
Filters:	AC (50/60 Hz, -20 dB or better) Muscle (25-35 Hz, -3dB or better) Base line drift (0.05, 0.1, 0.2 Hz, -3 dB or better) Low pass filter: off, 40 Hz, 100 Hz, 150 Hz	Common mode rejection:	> 105 dB
Display:	7" color TFT LCD display (800x480), 12 channels preview ID, HR, gain, speed, power status	DC offset voltage:	≥ ±400 mV
Monitor display:	ID, date, sensitivity, speed, filter, form, rhythm lead	Patient leakage current:	< 10 µA
User interface:	Touch screen (alphanumeric and symbol available), Keyboard, rotary push-knob (pop-up menu)	Frequency response:	0.05~200 Hz in 3 dB
Patient data:	ID, name, age, sex, height, weight, smoke, race, department, room number, study...etc.	Isolated defibrillation and ESU protected	
Basic measurement:	Heart rate (30~300 bpm, ± 3 bpm), PR/RR int., QRS dur., QT/QTc int., P-R-T axis, SV1/RV5/R+5 amp.	Signal quality control:	Lead fault detection, signal saturation detection Pacemaker pulse detection
Recorder:	Thermal print head, roll paper width: A4/Letter 215 mm (8.5")	ECG data storage:	storage for 200 ECGs, built-in memory
		Power:	input: 100-240 V, 1.5-0.75 A, 50-60 Hz output: 15 V, 4.2 A
		Battery (Li-ion):	Replaceable and rechargeable, lithium ion, 10.8V, 3250mA 6 hours of normal use or print 200 ECG pages (12 channel format at 25 mm/s and 10 mm/mV) Battery complete charge in 3 hours with power off
		Communication:	PC connection with LAN, WiFi (option), USB flash drive, USB barcode scanner (option)
		Safety conformity:	Class I, Type CF, CE, CSA, FDA, KFDA, CFDA, CCC

## ECG CABLE COMPATIBLE WITH MOST ECG BRANDS

### • 33328 ECG cable - 10 leads

Long lasting, individually tested cable compatible with the following ECG machines:

**BIONET:** Cardiocare, Cardiotouch, Cardio 7  
**CARDIOLINE:** E1, E1R, E3, Delta 300, Delta 360, C3.

### **CARDIETTE (Elettronica Trentina):**

Autoruler 12/1, Autoruler 12/3, Excel 103, Excel 106, Astron Comp 1, Astron Comp 3, Astron Comp 6, Start 100 P, Start 100 H, Start 200, Start 200HV, AR600, AR 600 ADV, AR1200, AR1200ADV.

**CARDIORAPID CAMINA:** K111, K112, K33, K36, K300 M, K300 P, K600 P, K600 D, K130 B, K 130 D.

**CONTEC:** 100G, 300G, 600G, 1,200G

**EDAN:** Smart SE-1, SE-3

**ESAOTE:** P80, P8000

**GIMA:** CARDIOGIMA 1M, 3M, 6M, 12, 12M

**HP:** Pagewriter 1513, 154B/C, 1514D, 1515A/B, 1517A.

**KONTRON EKG P80**

**MACQUAIRE CT100, CT200.**

**M4 MEDICAL:** M traces

**NIHON - KOHDEN** Cardiofax 651, 6581, 8110.

**PROGETTI all models:** EPG junior, EPG view, EPG6 view, EPG6 view plus

**SCHILLER AT/1, AT/2, AT/3, AT/4, AT/5, AT/6,**

**AT/10, CS6, CS12, CS100, CV6, P80.**



# GIMA ECG THERMAL PAPERS FOR DIFFERENT ECG BRANDS

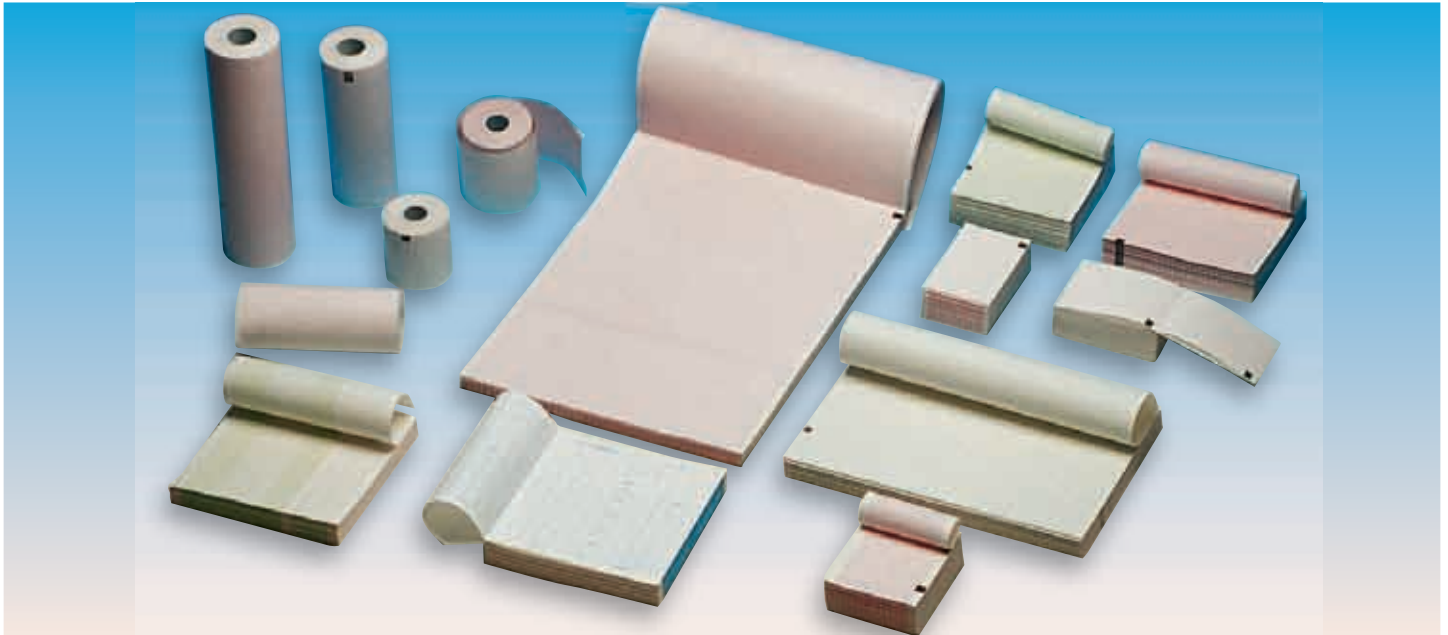

GIMA code	ECG MANUFACTURER AND MODEL	Type	Width mm	Length m	Sheet	Marker	Grid*	Min. order	GIMA code	ECG MANUFACTURER AND MODEL	Type	Width mm	Length m	Sheet	Marker	Grid*	Min. order
32951	ASPEL Ascard A4, B56, Mr. Blue, Mr. Silver 3 Topaz, grey, v.07.204, orange, red, v.07.303	roll	112	25	-	no	or/red	10	32969	300G, 300GA, 300GT	roll	80	20	-	no	or/red	10
32996	Ascard B5 eco, Mr. Green, mint	roll	58	25	-	no	or/red	20	32970	600G	roll	110	20	-	no	or/red	10
32952	Ascard, Mr. Gold, Gold/3	roll	210	25	-	no	or/red	5	32967	1200, 1201, 1212G	roll	210	30	-	no	or/red	5
32968	101G	roll	50	20	-	no	or/red	20	<b>DIMED</b>								
32989	300G, 3010	roll	63	30	-	no	or/red	20	32963	LTD400	roll	50	25	-	no	or/red	20
32969	iE3, iE300	roll	80	20	-	no	or/red	10	32996	LTD410, Heartscreen 60G	roll	58	25	-	no	or/red	20
33002	3030, 6010	roll	112	27	-	no	or/red	10	32964	LTD405S, LTD405W, LTD415 Heartscr. 80G	roll	80	25	-	no	or/red	10
32992	1200	roll	210	30	-	no	or/red	5	32951	LTD418, Heartscreen 112	roll	112	25	-	no	or/red	10
32962	1210, 1215	pack	210	140	215	yes	or/red	10	32965	LTD440, LTD445/S	pack	110	140	143	yes	or/red	20
33004	iE12A, iE-15, iE-20	pack	210	150	200	yes	or/red	10	32960	LTD450, LTD455/S, LTD455/W	roll	210	30	-	no	or/red	5
33005	ECG-1260	pack	210	140	140		orange	10	32966	LTD450, LTD455/S, LTD455/W	pack	210	295	150	yes	or/red	1
33007	iE6, ECG 3030, ECG 6010	pack	112	140	142		orange	20	<b>EDAN</b>								
32969	BLT, 1203A, E 30	roll	80	20	-	no	or/red	10	32963	SE-1	roll	50	25	-	no	or/red	20
32992	BLT-1212		210	30			orange	5	32964	SE-3	roll	80	25	-	no	or/red	10
32966	E70, E80	pack	210	295	150	yes	or/red	1	32965	SE-601	pack	110	140	143	yes	or/red	20
32950	Cardiocare/Cardiotouch	roll	215	25	-	no	or/red	5	32966	SE-6, 12, 1200 EXP	pack	210	295	150	yes	or/red	1
33046	BIOSET-HORMAN Bioset 3500	roll	110	30	-		orange	10	32960	SE-6, 12, 1200 EXP	roll	210	30	-	no	or/red	5
32969	3800	roll	80	20	-	no	or/red	10	32962	SE/1201	pack	210	140	215	yes	or/red	10
32951	BTL 08/MT, 08/MD, 08/MD3	roll	112	25	-		orange	10	<b>ELETTRONICA TRENITINA/CARDIETTE/CARDIOLINE</b>								
32996	BTL 08/MT, 08/MD, 08/MD3	roll	58	25	-	no	or/red	20	32971	Autoruler 12/1, comp. 1x12	roll	50	30	-	yes	blue	20
32953	08 MT, MD	roll	112	23	-	no	or/red	10	32972	Start 100	roll	130	27	-	yes	blue	10
32952	BTL 08/LC, 08/LT	roll	210	25	-	no	or/red	5	32973	AR 600, AR 600 Adv	roll	60	15	-	yes	blue	25
32954	Atria 3100/6100, quest	pack	210	300	200	yes	or/red	1	32977	AR 600 Adv, AR 600	pack	60	75	250	yes	blue	25
32955	ELAN 100	pack	112	100	300	yes	or/red	25	32974	AR 1200	roll	120	18	-	yes	blue	10
32956	Delta 1 plus	pack	60	100	300	yes	or/red	25	32978	AR 1200 (View/Adv)	pack	120	100	300	yes	blue	10
32957	Delta 1 plus	roll	60	30	-	no	or/red	20	32975	Daedalus, AR2100	roll	210	20	-	yes	blue	5
32958	Delta 3 plus	pack	112	100	300	yes	or/red	25	32976	Daedalus, Start 200, AR2100	roll	210	150	200	yes	blue	8
32960	Delta 60 plus, ECG 200L	roll	210	30	-	no	or/red	5	<b>ESAOTE BIOMEDICA</b>								
32961	Elan 2100, Delta 612	pack	210	280	200	yes	or/red	1	32980	P 80 base	roll	90	28	-	no	or/red	10
33053	ECG 100+, ECG 100S	pack	100	150	200	yes	or/red	10	32981	P 80 base	pack	90	70	400	yes	or/red	25
33052	ECG 100/L	roll	100	20	-		orange	10	32982	P 80 Power, P 80 SIX	pack	210	280	215	yes	or/red	1
33054	AR2100 (VIEW/ADV) - 66010042	pack	210	140	200	yes	or/red	8	32983	P8000 base	pack	80	70	300	yes	or/red	20
33055	ECG 200+	pack	210	295	180	yes	or/red	1	32984	P8000 Power	pack	210	280	200	yes	or/red	1
32963	ECG-1101B, 1101C, 1101G	roll	50	25	-	no	or/red	20	32985	Archimed 4240, Archiwin	pack	210	300	200	yes	or/red	1
33025	ECG-1103B, 1103G, 1103L	roll	63	30	-	no	or/red	20	32987	My Cardiopad base	pack	114	90	200	yes	or/red	20
33058	ECG-1103GW, 1103LW	roll	80	30	-	no	or/red	10	33040	Esaote my Cardiopad 2157036	pack	210	140	180	yes	or/red	5
33059	ECG-1106G, 1106L	roll	112	25	-	no	or/red	10	<b>FUKUDA ME - FUKUDA DENSHI</b>								
32950	ECG-1112L, 112M, T/12	roll	215	25	-	no	or/red	5	32988	501A, FX121, FCP-500, OP18TE	roll	50	30	-	no	or/red	20
32963	CM100	roll	50	25	-		orange	20	32989	FCP15, FCP11, OP110TE, OP119TE	roll	63	30	-	no	or/red	20
32969	CM300, H3	roll	80	20	-	no	or/red	10	32994	FCP2101, 2155, FX 2111, CASE10, FCP 7101, FX 7102	roll	145	30	-	no	or/red	10
32965	CM600	roll	110	20	-	no	or/red	20	32990	OP/358TE, FCP/131, FX3010, FX3101, FX-8822	roll	50	75	400	yes	or/red	20
32992	CM 1200 A/B	roll	210	30	-	no	or/red	5	32991	OP 111 TE, OP 115 TE, FX102	pack	63	75	400	yes	or/red	25
32966	CM 1200 A/B	pack	210	295	150	yes	or/red	1	32992	OP 112 TE, FX2111, FX7101, FX7102, FCP 2201 G	roll	210	30	-	no	or/red	5
32963	CM580 Cardiopoket	roll	50	25	-		orange	20	32965	OP222TE, FX7202	pack	110	140	143	yes	or/red	20
32968	90A, 100G	roll	50	20	-	no	or/red	20	<b>GIMA</b>								
									32996	Cardiogima 1M, 3M	roll	58	25	-	no	or/red	20
									32953	Cardiogima 6M, colour	roll	112	23	-	no	or/red	10
									32950	Cardiogima 12, 12M	roll	215	25	-	no	or/red	5
									<b>HEWLETT PACKARD</b>								
									32999	Page Writer 100/200, M1709A, M2483A	pack	210	300	200	hole	or/red	1
									32988	40453 A, 43120	roll	50	30	-	no	or/red	20

\*or/red: grid could be orange or red colour



# GIMA ECG THERMAL PAPERS FOR DIFFERENT ECG BRANDS

GIMA code	ECG MANUFACTURER AND MODEL	Type	Width mm	Length m	Sheet	Marker	Grid*	Min. order	GIMA code	ECG MANUFACTURER AND MODEL	Type	Width mm	Length m	Sheet	Marker	Grid*	Min. order
32996	INNOMED HearthMirror IKO 3, HearthScreen 60 IKO, 60 G	roll	58	25	-	no	or/red	20	33025	CARDIOFAX 8110, 9620, 1150K	roll	63	30	-	no	or/red	20
32964	HeartScreen IKO 80G-L, 80C-L	roll	80	25	-	no	or/red	10	33026	Cardio-fax GEM/1250/1950, ECG-9010/9020/9022	pack	210	140	215	yes	white	10
32953	HeartScreen 112 C-D	roll	112	23	-	no	or/red	10	32962	Cardio-fax GEM/1250/1950, ECG-9010/9020/9022	pack	210	140	215	yes	or/red	10
33004	HeartScreen 210	pack	210	150	200	-	orange	10	33027	GEM 9010, 9020, 9022, 1250, 1950	pack	110	140	143	yes	white	20
33059	ECG-1106G - ECG-1106L KENZ - SUZUKEN	roll	112	25	-	-	orange	10	33028	1500, 1550, 9110, 9130, 9132, 9320, 2250 PHILIPS	pack	210	295	170	yes	white	1
33002	Cardico 302/601	roll	112	27	-	no	or/red	10	32998	Page Writer TC/10	roll	110	25	-	no	or/red	10
33003	Cardico 302/601	pack	112	90	200	yes	or/red	20	32999	Page Writer TC/50 - TC/70	pack	210	300	200	hole	or/red	1
33058	Cardico 306	roll	80	30	-	-	orange	10	32997	Touch, TRIM I / II / III, Page Writer TC/20, TC/30 PROGETTI	pack	210	300	100	hole	or/red	1
32960	Kenz-Cardico 1210, 1211	roll	210	30	-	no	or/red	5	32953	EPG 612	roll	112	23	-	no	or/red	10
33025	ECG 305	roll	63	30	-	-	orange	20	32960	EPG 12 view	roll	210	30	-	-	orange	5
32988	103, R50-30R, TEC 8300 LUMED	roll	50	30	-	no	or/red	20	32964	EPG Project	roll	80	25	-	-	orange	10
33058	EUROECG 3view MARQUETTE - HELLIGE - GE	roll	80	30	-	-	orange	10	32996	EPG Basik-pocket	roll	58	25	-	no	or/red	20
33010	MAC PC	roll	108	23	-	no	or/red	10	33037	AT 1, AT 4	pack	90	90	390	yes	green	25
33011	Case 10-12-15, MAC 3000-5000	pack	215	280	300	hole	or/red	1	32982	AT 2, CS 200	pack	210	280	215	yes	or/red	1
32966	Cardiosmart, MAC 1200/1600	pack	210	295	150	yes	or/red	1	33038	AT 10	pack	210	140	250	yes	green	10
33012	MAC 400, MAC 600	pack	80	90	280	yes	or/red	25	32983	AT 101	pack	80	70	300	yes	or/red	20
33013	MAC 800	pack	110	140	200	yes	or/red	25	32984	AT 102	pack	210	280	200	yes	or/red	1
33058	MEDIANA YM-303	roll	80	30	-	-	orange	10	33039	AT110, AT 10 Plus, AT 2 Plus	pack	210	140	150	yes	green	5
29528	MEDICAL ECONET SMART - 3		152	25	-	-	green	10	32987	Cardiopad, MS 2010	pack	114	90	200	yes	green	20
32950	Cardio M - Cardio M Plus	roll	215	25	-	-	orange	5	33040	MS-2015	pack	210	140	180	yes	or/red	5
29522	SMART - 1	roll	215	23	-	-	green	5	33041	Cardioart FT/1	pack	114	150	64	yes	orange	20
33058	MEDIGATE MeCA 303i	roll	80	30	-	-	orange	10	33042	Cardioart AT/1	pack	80	70	300	yes	orange	20
33014	MINDRAY Beneheart R3	roll	80	20	-	no	or/red	10	33043	Cardioart AT/102-G2	pack	210	280	100	yes	orange	1
33016	Beneheart R3	pack	80	70	200	yes	or/red	25	32990	Cardiostat 1	pack	50	75	400	yes	or/red	20
32966	Beneheart R12 MORTARA	pack	210	295	150	yes	or/red	1	32991	Cardiostat 11	pack	63	75	400	yes	or/red	25
33017	Eli 50	pack	50	70	200	yes	or/red	25	32988	Cardipia 200 / 201N	roll	50	30	-	-	orange	20
33010	Eli 100	roll	108	23	-	no	or/red	10	32989	Cardipia 200, 203N	roll	63	30	-	no	or/red	20
33019	Eli 210, 250, 280, 350, 380	pack	210	300	250	yes	or/red	1	33046	Cardipia 400, 406RS	roll	110	30	-	no	or/red	25
33020	Eli 150	pack	108	140	200	yes	or/red	25	33047	Cardipia 800, 812RS	roll	215	30	-	no	or/red	5
33021	Eli 230	roll	210	20	-	no	or/red	5	33647	R-Series, X-Series	roll	80	25	-	-	white	10
32988	NIHON KOHDEN ECG-6651 - Def. Series TEC 7100 / 7200/ 7300	roll	50	30	-	-	orange	20	32964	X-Series	roll	80	25	-	-	orange	10
32994	Cardiofax 5403 - ECG-8240		145	30	-	-	orange	10	ZONCARE 32962	iMac 120 / iMac 1500 / iMac 1800	pack	210	140	215	-	orange	10
									32964	ZQ-1203G / iMac 300 / iMac 30	roll	80	25	-	-	orange	10

# 3M™ RED DOT™ ELECTRODES

GIMA code	3M code	3M™ RED DOT™ ELECTRODES	Minimum order
<b>Gel electrodes - short term diagnostics</b>			
33378	2330	3M™ Red Dot™ - 3.2 x 2.2 cm	bag of 100
<b>Foam monitoring electrodes</b>			
33293	2570	3M™ Red Dot™ - 4 x 3.5 cm	bag of 50
<b>Non woven monitoring electrodes</b>			
33299	2248-50	3M™ Red Dot™ - Pediatric - Ø 4.5 cm	box of 50
33297	2239	3M™ Red Dot™ - Ø 6 cm	box of 1,000*

\*20 bags of 50 pieces



**33378**  
3M 2330 resting ECG electrode with adhesive gel



**33293**  
3M 2570 electrode with foam tape and sticky gel - radiolucent. 5-days wearing time



**33299**  
3M 2248-50 pediatric monitoring electrode with micropore tape backing



**33297**  
3M 2239 monitoring electrode with micropore tape backing 3-days wearing time

# ECG GEL AND SPRAY

- 33266 ECG GEL - 250 ml - box of 40 tubes
  - 33267 ECG GEL - 5 l - box of 2 bags\*\*
  - 33268 ECG SPRAY GEL - 250 ml - box of 20 tubes
- Suitable for non pre-gelled electrodes, ECG latches and pendant switches in any ECG and exertional applications. Allows ECG waves clear transfer to equipment. It is hypoallergenic, does not irritate skin, does not contain oil and oily substances, does not contain formaldehyde and salt, has no toxic effects and is odourless.
- 33283 PUMP FOR BAG 5 l

\*\*Includes 1 empty bottle 250 ml and 1 nozzle for easy refill





# FIAB ECG UNIVERSAL ELECTRODES

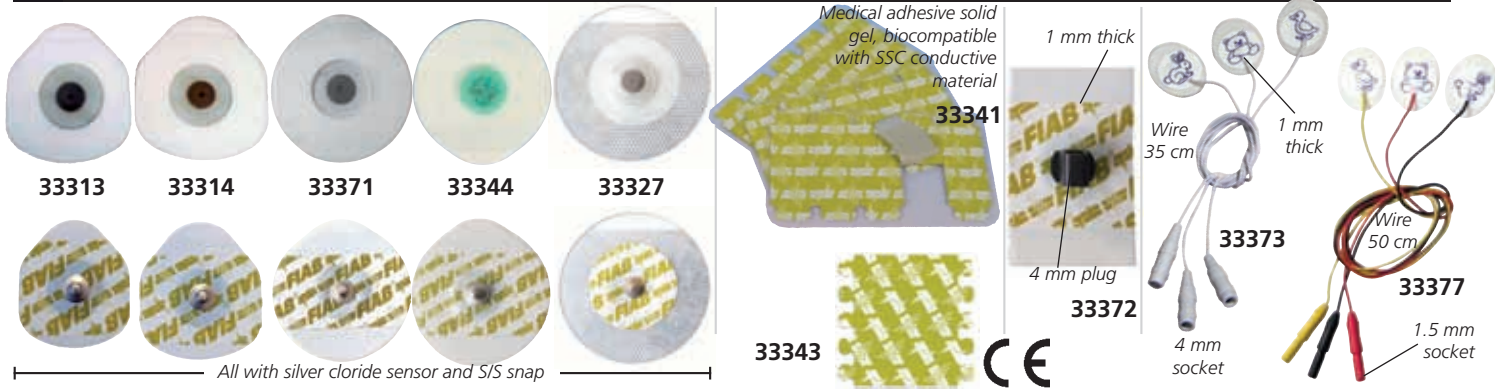

GIMA code	FIAB code	Material	Size	Gel	Shape	Connection	Patient	Application	Minimum order
33313	F9089P-100	Foam	Ø 32x36 mm	Solid	Oval	Snap	Pediatric	rest, stress, ECG holter	box of 2,000 (20 bags of 100)
33314	F9089-100	Foam	Ø 36x40 mm	Solid	Oval	Snap	Adult	rest, stress, ECG holter	box of 2,000 (20 bags of 100)
33370	F9060P	PE-Foam	Ø 40 mm	Solid	Round	Snap	Pediatric	rest, long term, stress, ECG holter	bag of 50
33371	F9060	PE-Foam	Ø 48x50 mm	Solid	Oval	Snap	Adult	rest, long term, stress, ECG holter	bag of 50
33344	F9067	PE-Foam	Ø 48x50 mm	Liquid	Oval	Snap	Adult	rest, stress and ECG holter	box of 1,200 (24 bags of 50)
33326	F2080P	Nonwoven	Ø 40 mm	Solid	Round	Snap	Pediatric	rest, long term, stress, ECG holter	box of 1,200 (24 bags of 50)
33327	F2080	Nonwoven	Ø 55 mm	Solid	Round	Snap	Adult	rest, long term, stress, ECG holter	box of 1,200 (24 bags of 50)
33341	F3001ECG	Gelled	34x23 mm	Solid	TAB	Alligator	Adult	rest ECG	bag of 100
33346	F3001ECG	Gelled	34x23 mm	Solid	TAB	Alligator	Adult	rest ECG	box of 5,000 (50 bags of 100)
33343	F3001NECG	Gelled	34x13 mm	Solid	TAB	Alligator	Pediatric, neonatal	rest ECG	box of 520 (13 bags of 40)
33372	F9047/4FL	PE-Foam	28x44 mm	Liquid	Rectang.	Plug 4 mm	Adult	rest ECG	box of 1,000 (20 bags of 50)
33373	F9053N	Foam	Ø 23x30 mm	Solid	Oval	4 mm socket	Pediatric, neonatal	monitoring ECG recording	box of 150 (5 bags of 30)
33377	F9058N	Foam	Ø 23x30 mm	Solid	Oval	1.5 mm socket	Pediatric, neonatal	long monitoring ECG recording	box of 150 (50 bags of 3)

# ADAPTORS FOR ECG ELECTRODES

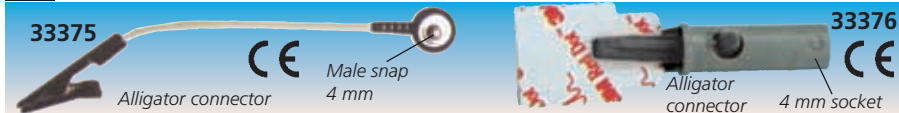

GIMA code	UNIVERSAL ADAPTERS FOR ECG ELECTRODES	Minimum order
33367	Set of 10 adaptors (6 white, 1 yellow, 1 green, 1 red, 1 black) for ECG electrodes with 4 mm snap - codes 33313, 33314, 33327, 33344, 33370, 33371	set of 10 pcs
33375	Alligator adaptor with wire - total length: 16,5 cm	10 pcs
33376	Alligator adaptor	10 pcs
33342	Multifunction adaptor - can fit both snap electrodes and TAB electrodes - size 14x54x17 mm	10 pcs
33374	Grabber adaptor - fit snap electrodes - size 22.5x33 mm	10 pcs

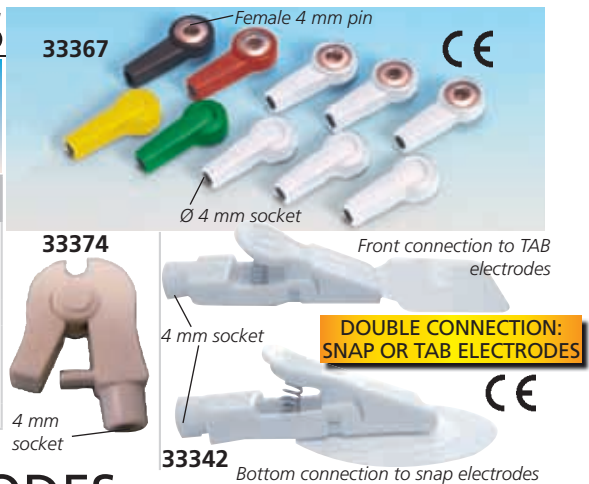

# LIMB CLAMP AND CHEST ELECTRODES

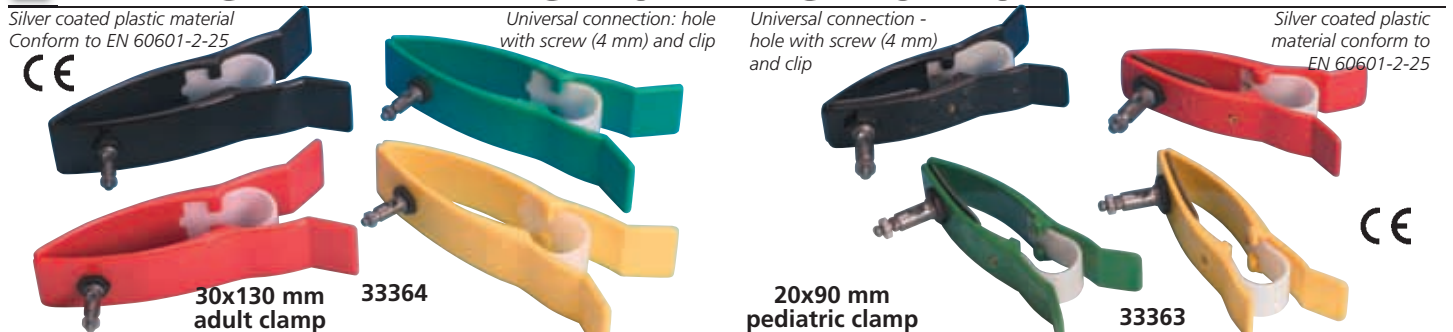

GIMA code	UNIVERSAL REUSABLE ECG ELECTRODES LATEX FREE - NICKEL FREE	Minimum order
33363	Set of 4 limb clamp electrodes (4 colours) pediatric	1 set
33364	Set of 4 limb clamp electrodes (4 colours) adult	1 set
33368	Set of 6 chest electrodes Ø 15 mm - silver coated	1 set
33365	Set of 6 chest electrodes Ø 24 mm - silver coated	1 set
33369	Set of 6 chest electrodes Ø 30 mm - silver coated	1 set
33323	Set of 6 chest electr. Ultra Ø 24 mm - silver coated	1 set
33324	Set of 6 chest electr. Ultra Ø 30 mm - silver coated	1 set

# AMBU BLUESENSOR ECG ELECTRODES

4 mm	Tab or snap	GIMA code	AMBU code	Description	Application	Gel type	Backing material	Size (mm)	Shape	Shelf life* (month)	Radiolucent	Connector type	Minimum order	Packaging
		<b>33200</b> <b>33201</b>	SU-00-A/60 SU-00-C/100	BlueSensor SU	Resting	Wet	Polymer	49x33	Teardrop	24	No	4 mm TAB	box of 1,200 box of 1,200	20 pouches of 60 12 pouches of 100
		<b>33203</b>	L-00-S/25	BlueSensor L	Long-term	Wet	Microporous	68.2x55	Round w/offset	24	No	Snap	box of 500	20 pouches of 25
		<b>33204</b> <b>33205</b> <b>33206</b>	VL-00-S/25 VL-00-S/25 VL-00-A/25	BlueSensor VL	Long-term	Wet	Microporous	72x68	Round w/offset	24	No	Snap Snap 4mm	box of 25 box of 500 box of 500	1 pouch of 25 20 pouches of 25 20 pouches of 25
		<b>33208</b> <b>33209</b>	R-00-A/25 R-00-S/25	BlueSensor R	Stress test	Wet	Foam	57x48	Round w/offset	24	No	4mm Snap	box of 500 box of 500	20 pouches of 25 20 pouches of 25
		<b>33211</b> <b>33212</b>	M-00-A/50 M-00-S/50	BlueSensor M	Short-term	Wet	Polymer	40.8x34	Round w/offset	15	No	4mm Snap	box of 1,000 box of 1,000	20 pouches of 50 20 pouches of 50

\*Shelf life means maximum life from production date. Average Gima shelf life is 50 to 90% of maximum life

### AMBU® BlueSensor

BlueSensor is the world's most time and cost efficient range of electrodes that delivers unmatched readings, user convenience and patient comfort. BlueSensor ensures that you don't get your workflow disrupted by false alarms or have to waste time resolving problems with electrode adhesion.

### Exact monitoring - clear picture

BlueSensor electrodes give a fast and reliable trace without the need for skin preparation, maximizing comfort for the patient. We know that fast, exact monitoring that ensures a clear picture of the patients' heartbeat is essential to accurate diagnoses.



- AMBU® BLUESENSOR SU**  
 - highly conductive wet gel  
 - superior quick adhesion  
 - unique offset connector  
 - fitting or tab  
 - occlusive backing material  
 - high quality Ag/AgCl sensor

- AMBU® BLUESENSOR L**  
 - highly conductive wet gel  
 - combination of instant and long-term adhesives  
 - breathable microporous material  
 - unique offset connector  
 - high quality Ag/AgCl sensor

- AMBU® BLUESENSOR VL**  
 - highly conductive wet gel  
 - combination of instant and long-term adhesives  
 - breathable microporous material  
 - unique offset connector  
 - high quality Ag/AgCl sensor

- AMBU® BLUESENSOR R**  
 - highly conductive wet gel  
 - superior adhesion  
 - comfortable foam backing  
 - large measuring area  
 - unique offset connector  
 - high quality Ag/AgCl sensor

- AMBU® BLUESENSOR M**  
 - highly conductive wet gel  
 - superior adhesion  
 - occlusive backing material  
 - unique offset connector  
 - high quality Ag/AgCl sensor

# AMBU WHITESENSOR ECG ELECTRODES

	GIMA code	AMBU code	Description	Application	Gel type	Backing material	Size (mm)	Shape	Shelf life* (month)	Radiolucent	Connector type	Minimum order	Packaging
	<b>53900</b>	4540	WhiteSensor 4540	Resting	Wet	Foam	32x44	Rectangular	24	Yes	4 mm	box of 300	5 pouches of 60
	<b>53902</b>	4200	WhiteSensor 4200	Short-term	Solid	Foam	28x44	Rectangular	30	No	Snap	box of 1200	12 pouches of 100
	<b>53904</b>	WS-00-S/50	WhiteSensor WS-00-S/50	Short-term	Solid	Foam	36x40	Teardrop	30	No	Snap	box of 600	12 pouches of 50
	<b>53906</b>	0315M	WhiteSensor 0315M	Short-term	Solid	Polymer	35x21	Tab	24	Yes	Tab	box of 500	10 pouches of 100
	<b>53910</b>	4500M-H	WhiteSensor 4500M-H	Stress-test Short-term	Wet	Foam	50x48	Round	24	No	Snap	box of 300	5 pouches of 60
	<b>53912</b>	4500M	WhiteSensor 4500M	Stress-test Short-term	Wet	Foam	50x48	Round	24	Yes	Snap	box of 300	10 pouches of 30

### AMBU® WhiteSensor

WhiteSensor electrodes combine versatility with quality and functionality. The wide range of sizes, shapes, gel types and backing materials makes it easy to choose the optimal device for every situation. Carefully selected features to match each

individual situation, covering all patient needs in monitoring. Flexible and reliable materials and adhesives, able to follow skin movements without lifting off, allow both patient comfort and signal quality.

- AMBU® WHITESENSOR 4540**  
 Highly conductive wet gel system which guarantees a fast and accurate trace during 12-lead ECG procedures. Thanks to the strong high-tack adhesive foam, time wasted due to electrode drop-off will be reduced. The radiolucent 4 mm slot connector allows the patient to undergo X-ray and scanner procedures.  
 5 pieces per card.

- AMBU® WHITESENSOR 4200**  
 Conductive solid gel to ensure a good signal quality during short-term ECG monitoring applications. Thanks to the flexible foam backing material, the electrode ensures ease of use and comfort during application.

- AMBU® WHITESENSOR WS-00-S/50**  
 Highly conductive solid gel with strong adhesion to ensure a good signal quality during short-term ECG monitoring applications. Thanks to the flexible foam backing material, the electrode ensures ease of use and comfort during application.

- AMBU® WHITESENSOR 4500M-H, 4500M**  
 It features a wet gel with good adhesion to ensure a good signal quality during short-term ECG monitoring applications. Thanks to the flexible foam backing material, the electrode ensures ease of use and comfort during application.



- AMBU® WHITESENSOR 0315M**  
 Small size tab electrode with solid gel for 12-lead ECG. The fish tail tab design prevents electrode lift-offs even if the adapter kinks.  
 10 pieces per card.

# ECG PATIENT CABLES - COMPATIBLE WITH MOST BRANDS



## ECG PATIENT CABLES 10 LEADS

Compatible patient cables for electrocardiography and exercise stress tests.

In order to ensure the patient's safety under any circumstance, we have supplied all our cables with an independent defibrillation protection.

Quality is ensured by the design, the manufacturing process and the final tests performed through computerised workstations. Standard cable length 2.2 m (from connector to yoke), chest leads 0.76 m, limb leads 1.2 m.

Few cables with 3.5 m length to improve usability in exercise stress tests.

Multilingual instructions: GB, FR, IT, ES, PT, DE, GR, RO.



CONNECTORS TO ECG					LEADS		CONNECT.	BRAND	COMPATIBLE MODEL
1	2	3	4	5	BANANA	SNAP			
Leads		Snap	Cable length*	Connect.	BRAND	COMPATIBLE MODEL			
Banana	Snap								
2.2 m	2.2 m	3.5 m							
54000	54001	54022		1	ASPEL	All models with Dsub connector 15 pins and screws			
54002	54003	-		2	BIOCARE	ECG101, 101G, 300, 300G, 6010, 8080, 3030, 9801, 9803, 9803G, 1200, 3000, 3010, 3030, 6010, 1210, 1216, 1230 (12 channels), 9803, iE101, iE300.			
54002	54003	-		2	BIOLIGHT	BLT-1203, E12A, E12, E65, E70, E80			
54000	54001	54022		1	BIONET	Cardiocare 2000, Cardiotouch 3000, Cardio 7, Cardio 7_S, Cardiocare 3000_S			
54000	54001	54022		1	BTL	BTL-08 L, M, S series, CardioPoint-ECG C300 and C600, CardioPoint-ERGO C300 and C600			
54004	54005	54020		1	CAMINA-EUROCAMINA	Cardiorapid and CardioSwift series			
54004	54005	54020		1	CARDIETTE-ELETTRONICA TRENTINA	AR600, 600adv, 600view; AR1200, 1200adv, 1200view; AR2100, 2100adv, 2100view. Start 100P, 100H, 200, 200HV. Daedalus View, View HES, View Ergo. DOC 101,103; micro, microruler and microtel series; Autoruler series; Excel series: Daedalus 346.			
54006	54007	-		3	CARDIOLINE	Delta 1, 3, 30, 30D, 60, 60D, 1plus, 3plus, 3/6plus. Elan, Elan1100. Delta 60plus, ElanStress			
54004	54005	54020		1		ECG100 and ECG200 series. All models AR600, 1200, 2100; E1, E1R, E3			
54002	54003	-		2	CAREWELL	ECG-1101B/G, -1103B/G/W/L/LW, PCECG-50 and all models with Dsub connector 15 pins (except -1106L, -1112L/M, T10, T12)			
54004	54005	54020		1	COLSON - DUPONT	Cardi-3, E1, E3 Cardiopraticque, Daedalus 346. All models of the series: AR, Cardipocket, Cardio, Excel, Autoruler, Microruler. All models with Dsub connector 15 pins			
54002	54003	-		2	COMEN	H3, H12, CM100, 300, 600, 1200, 1200A, 1200B and all models with Dsub connector 15 pins			
54002	54003	-		2	EDAN	SE-1, -3, -3W5, -100, -300, -6, -600, -12, -12 express, -1200, -1200 express, -1010 (not wireless). SE-601A-B-C, -1201, ST-1212, SE-12 express			
54011	54012	54021		1	ESAOTE	P80, P80six, P80power, P8000, P8000power, P8000 tele, MyCardiopad, MyCardiopad XL, AT-10 plus, AT-102 plus, Cardiovit M2015 ecc			
54004	54005	54020		1	FARUM	All models with Dsub connector 15 pins			
54002	54003	-		2	FAZZINI	All models with Dsub connector 15 pins			
54008	54009	-		4	FUKUDA DENSHI	Autocardiner & Cardimax. FCP11, FCP2101A, FCP2155, FCP2201A, FCP4101A, FX101, MCP302, FX2111, FCP2155, FCP7101, FX3010. FX328UY, FX4010, FX7101, FX7102, FX7202, FX7302, FX7402, FX7542, FX8222, FX8322, FX8328, FX328U			
54010	-	-		5	GE MARQUETTE	MAC 400, 500, 600, 800, 1000, 1100, 1200, 1600, 2000, 3500			
54000	54001	54022		2	GIMA	Cardiopocket, Smart SE-1, -3, -6, -12 Express, Gimaplay 1, Cardiogima 1M, 3M, 6M, 12, 12M, Colour ECG, PC-ECG 33320, 33321; Acquisition box series MGY. All models with Dsub connector 15 pins			
54000	54001	54022		1	INNOMED	Heart Mirror & Heart Screen series. Cardio PC/E.			
54002	54003	-		2	INTERMED	ECG-1101B/G, -1103B/G/W/L/LW, PCECG-50, all models with Dsub connector 15 pins (except 1106L, -1112L/M, T10, T12)			
54000	54001	54022		1	M4MEDICAL	M-trace PC, EX, 5.7", mini			
54000	54001	54022		1	MACQUAIRE	CT-100, -200, -200i, -200CV			
54000	54001	54022		1	MEDICAL ECONET	Cardio-M, Cardio-M plus, Cardio-MPC, Cardio E3			
54004	54005	54020		1	MEGOS	3/12b, 3/12i; Comp1x12, Comp3x12, Comp6x12, Comp3, Comp12, Comp60 and models with Dsub connector 15 pins			
54002	54003	-		2	MINDRAY	DECG-Q3A, BeneHeart R3, BeneHeart R12.			
54000	54001	54022		2	MORETTI DIMED	Pc-ecg Seiva and all models with Dsub connector 15 pins			
54002	54003	-		2	NIHON KOHDEN	Cardiofax C, Cardiofax M, Cardiofax Q, Cardiofax S, Cardiofax V. ECG-1150, ECG-1250, ECG-1250A, ECG-1250K, ECG-1350, ECG-1350A, ECG-135DK, ECG-2150, ECG-2250, ECG-2350, ECG-9010, ECG-9020, ECG-9022, ECG-9110, ECG-9110K, ECG-9130, ECG-9130K, ECG-9132, ECG-9620, ECG-9620L, PEA-1110, ECG-651.			
54000	54001	54022		1	PROGETTI	MyECG, PG ECG and all models with Dsub connector 15 pins			
54011	54012	54021		1	SCHILLER	AT-1, 1G2, -2, -2plus, -2light, -4, -101, -104, -110, -5, -6, -10, -10+, -10plus, -102, -102G2, -60, -100, -104PC. CS-6, -6/12, -12, -100, series -200 MS-2007, -2010, -2015			
54002	54003	-		2	SINOHERO	SE101, SE505, SE508, SE600, SE1200, SE1200 Light and models with Dsub connector 15 pins			
54002	54003	-		2	SONOSCAPE	All models with Dsub connector 15 pins			
54002	54003	-		2	SONOSTAR	SE-1, -1A, -3, -3B, -3C, -6, -6A, 12A, -12B, -12P, Ebox-1 and models with Dsub connector 15 pins			
54000	54001	54022		1	SPACELABS	CardioDirect C012 US8, CD12-S USB; Cardiotrack 12, Cardiocollect, Voyager V6, V12.			
54002	54003	-		2		CardioExpress SL3, SL6, SL12.			
54000	54001	54022		1	SPENGLER	Cardiomate 3, Cardiomate 6, Cardiomate 12			
54004	54005	54020		1	ST ELECTROMEDICINA	531, 531i, 563, 563i. ar600adv, ar600view, ar1200adv, ar1200view			
54002	54003	-		2	ZONCARE	ZQ-1201, -1201G, -1203, -1203G, -1203S, -1206, -1212, IMAC730, IMAC 300			

\*Length from connector to yoke

## SONY MEDICAL PRINTERS

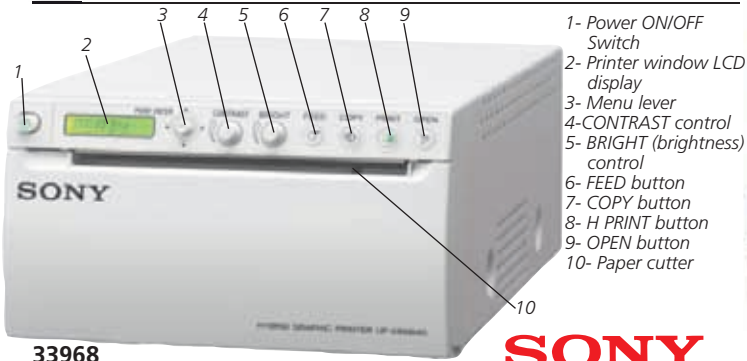

- 1- Power ON/OFF Switch
- 2- Printer window LCD display
- 3- Menu lever
- 4- CONTRAST control
- 5- BRIGHT (brightness) control
- 6- FEED button
- 7- COPY button
- 8- H PRINT button
- 9- OPEN button
- 10- Paper cutter

33968

• 33968 SONY HYBRID GRAPHIC PRINTER UP-X898 MD - black/white

Produces A6 size printings in about 2 seconds, with superb print quality with 325 dpi and grey level of 256 steps. Can take both analogue video and digital signal inputs. 110-240 V AC, 50/60 Hz. Space saving design: 154x240xh 88 mm, for flexible integration into medical carts. Multilingual manual: GB, FR, IT, PT.



## SONY ORIGINAL PAPER



SONY VIDEOPRINTER PAPERS

- 72726 SONY PAPER - UPP-110 HD - box of 10 rolls High density printing paper - 110 mm x 20 m
- 72727 SONY PAPER - UPP-110 HG - box of 10 rolls High glossy printing paper - 110 mm x 18 m
- 72728 SONY PAPER UPP-110S - box of 10 rolls
- 72729 SONY PAPER UPP-110HA - box of 10 rolls
- 72735 SONY COLOUR PAPER UPC-21L (4 ink rolls + 200 supports 144x100 mm)



33993

• 33993 SONY COLOUR PRINTER UP-25 MD

High quality analogue A6 Dye. Sublimation Printer for use in medical applications. An ideal technology for making high quality, accurate photographic prints. See [www.gimaitaly.com](http://www.gimaitaly.com)

## MITSUBISHI ORIGINAL PAPER



- 72740 MITSUBISHI PAPER K65HM-CE - box of 4 High density, high contrast thermal paper, approximately 215 prints per roll.

## COMPATIBLE PAPERS FOR SONY AND MITSUBISHI PRINTERS

ULTRASOUND COMPATIBLE PAPER FOR VIDEOPRINTERS

Top quality thermal print media perfectly fitting Sony and Mitsubishi thermal printers.

**Long lasting image durability for high storage durability**

- high humidity and heat resistance for long storage
- strong resistance to water, finger prints and ultrasound gel drops.

**Precise, high resolution image reproduction**

- first class colour intensity for highest black colour density
- outstanding, bright, sharp and detailed medical image

**High glossy, brilliant, photorealistic reproduction**

**Trouble-free printing and long-term use of printer**

- easy tearing along the cross direction
- minimum curling for flat photo media and easy filing
- built-in anti-electrostatic layer preventing thermal head damage.



GIMA code	Compatibility		Paper grade	Size mm x m	Minimum order
	SONY	MITSUBISHI			
72745	UPP-110HG	K91HG/KP91HG	high glossy	110x18	box of 5
72746	UPP-84HG	-		84x12.5	box of 10
72747	UPP-110HD	K65HM/KP65HM	high density	110x20	box of 5
72748	-			110x20	box of 5
72749	UPP-210HD	-	standard	210x25	box of 5
72750	UPP110S	-		110x20	box of 5
72751	-	K61S/KP61S/KP61B	high density	110x20	box of 5
72752	UPP-84S	-		84x13.5	box of 10
72753	ULSTAR-110HD	-	matt	110x20	box of 5

## GIMA ULTRASOUND GEL



BLUE

TRANSPARENT

33276

33288

33272

33286+33283

33277

33289

33273

33287

GIMA code	ULTRASOUND GEL	Minimum order
33269	Sterile ultrasound gel - sachet - 20ml - transp	box of 48
33271	Ultrasound gel - sachet - 20ml - transparent	box of 200
33270	Ultrasound gel - tube 60 ml - transparent	box of 12
33272	Ultrasound gel - tube 250 ml - blue	box of 40
33273	Ultrasound gel - tube 250 ml - transparent	box of 40
33288	Ultrasound gel - bottle 1 l - blue	box of 18
33289	Ultrasound gel - bottle 1 l - transparent	box of 18
33276	Ultrasound gel - tank 5 l - blue	box of 2*
33277	Ultrasound gel - tank 5 l - transparent	box of 2*
33286	Ultrasound gel - bag 5 l - blue	box of 2**
33287	Ultrasound gel - bag 5 l - transparent	box of 2**
33283	Pump for tank 5 l and bag 5 l	

\*Includes 2 empty bottles 250 ml \*\*Includes 1 empty bottle 250 ml and 1 nozzle

### GIMA ULTRASOUND GEL

Hypoallergenic, water soluble gel suitable for ultrasonography, doppler and defibrillator applications. It ensures the ultrasound waves come to the equipment display in a clear and uninterrupted way. Salt, formaldehyde, fragrance free.



33270

33271

33269

## GEL CLEANER

- 33281 GEL PROBE CLEANER 250 ml 33281

It removes the gel left over the probe, makes the image clearer and extends the probe life. Thanks to the active agents contained, it prevents the bacteria to pass from patient to patient, and it ensures hygiene. Alcohol-free.



## COSMETIC GEL

- 33252 33252



33253



33256



## TECARTHERAPY CREAM

- 33251 TECARTHERAPY CREAM 1 l 33251

It allows to reduce the contact impedance between the probe and the skin. The high conductivity ensures the best results both in the capacitive phase and in the resistive phase of the treatment. Preservatives and dyes used are non-toxic. Latex free.



## EEG PASTE

- 33262 EEG PASTE - 400 g 33262

Used with EEG electrodes in EEG application for brain mapping. Thanks to the active substances in its content, it allows the electrode to cling to the strand of hair easily and provides conductivity. It is hypoallergenic, does not irritate skin, soluble in water and can be cleaned easily. Does not contain oil and oily substances. It has no toxic effects and odour.



### KONIX COSMETIC LASER & CAVITATION GEL

Laser & Cavitation gel reduces the pain that patients experience during depilation and makes the device last longer by cooling the device head and window. Thanks to the vacuum technology, its active substances and its high viscosity preserve probe from damages. It is not affected by the body salt during the use, ensures an easy application.

**Technical properties:** it is hypoallergenic, does not irritate skin, is water soluble and easily cleanable. Oily substances, formaldehyde and salt free. No toxic effects and odourless.

GIMA code	COSMETIC LASER & CAVITATION GEL	Minimum order
33253	Cosmetic gel - tube 250 ml	box of 40
33252	Cosmetic gel - bottle 1 l	box of 18
33256	Cosmetic gel - bag 5 l	box of 2**
33283	Pump for bag 5 l	

\*\*Includes 1 empty bottle 250 ml and 1 nozzle for easy refill

# POCKET DOPPLER WITH INTERCHANGEABLE OR FIXED PROBES



TECHNICAL SPECIFICATIONS	
<b>Ultrasound</b>	<b>Power supply</b>
Frequency: 2, 5 or 8 MHz continuous wave	Battery 9V Alkaline (not included)
Transducer: 2 crystal narrow beam	Expected battery life: >9 hours
Output power: <15mW/cm <sup>2</sup> SATA	<b>Output</b>
Audio Response: 300Hz - 4 KHz	Headset: Audio output to optional headset (not included)
<b>Unit Controls</b>	Material: ABS / Noryl
Keys: 1 Key (for unit on/off)	Size - weight: 150 mm by 75 mm - 299 g
Controls: rotary volume	Classification: Class I Type B - IEC 60601-1
Indicators: Yellow battery low LED	

## GIMA POCKET DOPPLERS

Small, lightweight, high sensitivity pocket Doppler. Its probes are ideal for use by a General Practitioner, vascular specialist for routine vascular examination in ER for vessel location, or by specialists in diabetes, urology and gynaecology.

Vascular flow signals and FHR are easily located using the transducer while internal signal processing minimizes noise artefacts.

The flow signal is also available to the user via the built-in loudspeaker with output level controlled by rotary volume control.

2 years warranty.

Supplied in a nice bag with probe, cable, gel tube and 7 languages user manual: GB, FR, DE, IT, ES, GR, PT.



GIMA code	GIMA POCKET DOPPLERS
33120	DOPPLER V2005 with 5 MHz fixed vascular probe
33121	DOPPLER V2008 with 8 MHz fixed vascular probe
33123	DOPPLER V2000 (without probe)
33126	2 MHz interchangeable probe - foetal for V2000
33127	5 MHz interchangeable probe - vascular for V2000
33128	8 MHz interchangeable probe - vascular for V2000
29511	ON/OFF membrane switch spare for 33120/3

# SONOTRAX DOPPLERS

Large backlight LCD display (29493 only)

Up to 4 hours continuous use

CE 0123

FDA

**SUPPORT 2MHz, 3MHz, 4MHz, 8 MHz WATERPROOF PROBES**

29490 29491

Interchangeable, water proof probes

29946 Probe not included

29493

TECHNICAL SPECIFICATIONS	
Size:	32x85x138 mm
Weight:	290 g (including battery)
Heart rate range:	50-210 bpm
Resolution:	1 bpm
Accuracy:	± 3 bpm
LCD display:	45x25 mm (only code 29491-93)
Auto average and manual mode	
Recording length:	480 s / 240 s
Auto power-off to save power	
Manual:	GB, IT - on request: DE, ES, FR, PT.

GIMA code	DOPPLERS AND INTERCHANGEABLE PROBES - LATEX FREE
29490	SONOTRAX LITE DOPPLER - without probe - with bag
29491	SONOTRAX BASIC DOPPLER - with display - without probe - with carrying bag
29493	SONOTRAX PRO II DOPPLER with backlit display built-in audio recorder and rechargeable batteries with battery charger - without probe - with carrying bag
29496	2MHz waterproof probe - gynaecology
29497	3MHz waterproof probe - gynaecology
29498	4MHz waterproof probe - vascular
29499	8MHz waterproof probe - vascular
29500	Rechargeable Ni-Mh battery for 29493 - spare

# GIMASONIC COLOUR DOPPLER

## COLOUR SCREEN POCKET DOPPLER - without probe

- built-in speaker
  - TFT-LCD, real-time display of FHR
  - three working modes: real-time FHR, average FHR and manual calculation
  - display of FHR, bar graph and heartbeat waveform, red alarm for abnormal FHR
  - low power consumption, continuously work for more than 8 hours with two "AA" batteries
  - indication for probe-off and low battery
  - range of probes for foetal or vascular use: 2, 3, 8 MHz probe
- Suitable for use after the 12<sup>th</sup> week of pregnancy
- Multilingual box and manual: GB, FR, IT, ES, PT, DE.

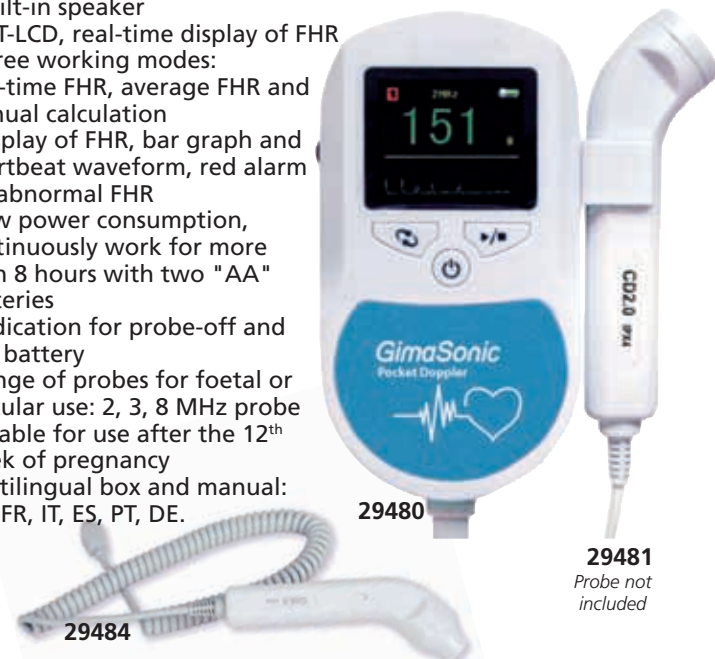

TECHNICAL SPECIFICATIONS	
Ultrasound working frequency:	2 MHz ± 10%
Fetal heart rate:	range: 50-240 bpm
	resolution: 1 bpm
	accuracy: ± 2 bpm
Alarm:	high limit: 160 bpm
	low limit: 120 bpm
Ultrasound intensity:	< 5 mm/cm <sup>2</sup>
Auto power off after 1 minute no signal	
Size - weight:	135x92x29 mm - 245 g
Power supply:	2 AA Batteries LR6 - 1.5 V DC

GIMA code	GIMASONIC COLOUR SCREEN DOPPLER
29480	GIMASONIC Colour screen doppler - without probe
29481	2 MHz waterproof* probe - gynaecology
29482	3 MHz waterproof* probe - gynaecology
29484	8 MHz waterproof* probe - vascular

\*Waterproof level IPX4, only splash proof, not immersion proof.

# MINDRAY DP-10 AND DP-20 DIGITAL ULTRASOUND SYSTEM

## DP-10 slim and smart

Good image quality, easy to use and lightweight to take it anywhere. It combines fashionable design, diagnostic confidence and economy.

## DP-20 exceeds your expectations

Smart portable B/W ultrasound system with advanced features

### Display modes and imaging processing:

Broadband, multi-frequency imaging: B, B/B, 4B, B/M, M

### Imaging processing:

- multi-frequency probes for 2D imaging modes
- iClear: speckle reduction image
- THI (Tissue Harmonic Imaging) with convex probe 33976 only
- TSI (Tissue Specific Imaging)
- zoom function: spot zoom, pan zoom
- ExFOV (Extended field of view)

Extended view of the anatomical structure on all convex and linear probes allow to discover better diagnostic information.

- iTouch (Auto image optimization)
- colour map

### User interface

- alphanumeric QWERTY keyboard with backlight
- trackball: speed presettable
- 8-segment TGC
- user defined blank keys: shortcut for easy access to menus

### iStation™ intelligent workflow

- intelligent patient data management system
- integrated search engine for patient data
- detailed patient information review
- intelligent data backup/restore
- patient data/image sending, data deleting (USB, DVD, DICOM)
- exam managing: activate exam

### Storage/review mode:

- image archive on hard disk and USB mobile storage medium, temporary saving in cine memory, directly transfer report to PC
- 2 USB ports
- multiple image formats: BMP, JPG, DCM, FRM, AVI, DCM, CIN
- iVision: demo player
- Cine review: auto, manual (auto review segment can be set), supports linked cine review for 2D, M images
- Cine memory capacity (max.)
- clip length presettable: 1-60 s

B mode: 11959 frames M mode: 110.0 s

Supplied with GB, IT manual and CD manual (GB, FR, IT, ES, PT, DE, RU, BR).

GIMA code	DIGITAL ULTRASONIC DIAGNOSTIC IMAGING SYSTEM
33989	MINDRAY DP-10 B/W system with 1-probe connector, 12.1" high resolution LED monitor, 2 USB port, 1 VGA OUT port, 1 video OUT, 1 S-Video OUT, software, without probe
33991	MINDRAY DP-20 portable B/W system with 1-probe connector, 12.1" high resolution LED monitor, 2 USB port, THI, iStation™, software package, without probe
<b>PW DOPPLER - optional for old models</b>	
33969	PW (Pulse Wave) doppler for 33970, 33971 (usable with probes 33976, 33977 only)

ACCESSORIES	
33875	Needle guided brackets for Linear probe (33977, 33983)
33876	Needle guided brackets for Micro-Convex probe (33979, 33984)
33974	Lithium-ion rechargeable battery for DP-20
33985	Carrying bag for DP-10, DP-20, DP-30
33986	UMT-110 mobile trolley for DP-10, DP-20, DP-30
33968	SONY HYBRID GRAPHIC PRINTER X898 MD

PROBES DP-10 - DP-20		FREQUENCY (MHz)		● Main application										
GIMA code	Mindray code	Scanning method	Main freq.	Probe band width	ABDOMINAL	OB / GYN	UROLOGY	SMALL PARTS	CARDIOLOGY	MSK	VASCULAR	PEDIATRIC	ORTHOPEDIC	INTRAOPERATIVE
33976	35C50EB	Convex	3.5	2.0 - 5.0	●	●	●							
33977	75L38EB	Linear	7.5	5.0 - 10.0						●	●	●	●	
33978	65C15EA	Micro-convex	6.5	5.0 - 8.5										
33979	65EC10EB	Micro-convex	6.5	5.0 - 8.5										
33980	35C20EA	Micro-convex	3.5	2.0 - 5.0	●	●	●							
33983	75L53EA	Linear	7.5	5.0 - 10.0	●					●	●	●	●	

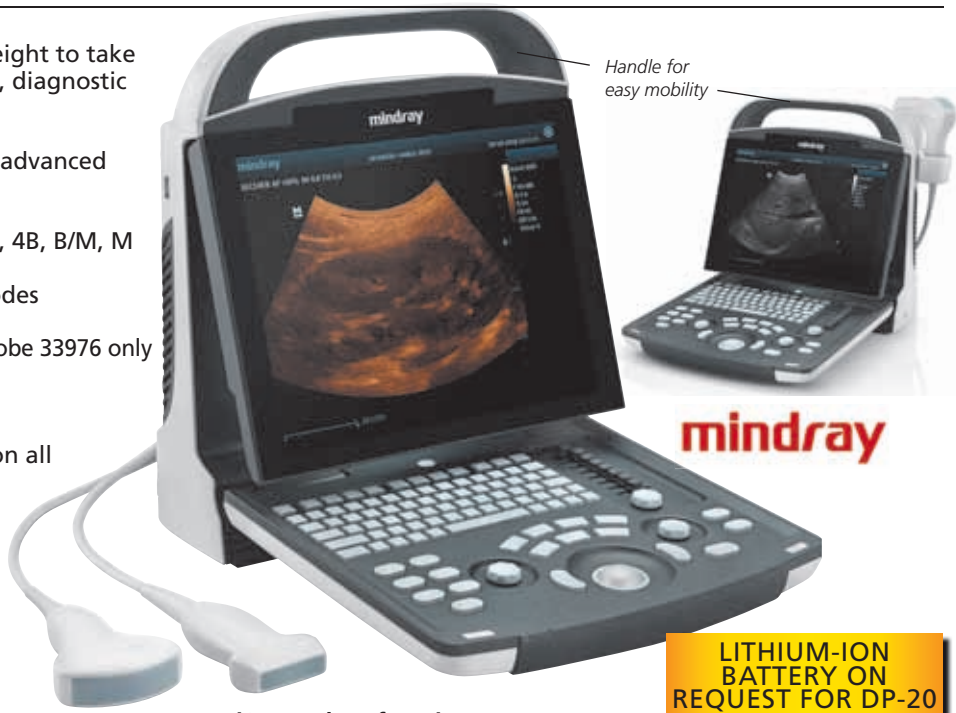

**LITHIUM-ION BATTERY ON REQUEST FOR DP-20**

### iScanHelper function

Dedicated inbuilt tutorial function to enhance ultrasound experience.

- wide selection of application specific exam planes
- anatomical illustrations
- scanning reference pictures
- standard ultrasound images
- tips on scanning and diagnosing

### Standard PW doppler imaging usable with all probes

It allows to access blood flow in different clinical conditions. With PW, doctors will be able to:

- differentiate non echoarea and blood vessels
- distinguish arteries and veins
- evaluate blood flow velocity for more comprehensive diagnosis
- check the health of a fetus by blood flow evaluation of the umbilical cord

### System configured with DICOM modules

It allows to perform storage, print, Worklist, storage commitment, retrieve applications when it is connected to the relevant DICOM servers.

### Features

Parameter adjustment: Gain, Sample volume size, Scale, Steer, Dynamic range, Wall filter, etc.

Measurement: Trace, HR, Velocity, PS/ED, PI, RI, etc.

TECHNICAL SPECIFICATIONS	
Dimension:	16x29xh 35.4 cm (6.3"x11.4"xh 13.9")
Weight:	5.1 kg
Display:	12.1" LED, high-resolution 1024x768
Display language:	DP-10, DP-20: GB, FR, DE, IT, ES, PT, RU, CZ, PL
Power:	AC100-240 V, 50-60 Hz
	Rechargeable lithium-ion battery (DP-20 only) - on request
	Size: 40 x 24 x h 42 cm





# MINDRAY DP-50 EXPERT ULTRASOUND DIAGNOSTIC SYSTEM



33992



33992 + 33988

Supplied with GB, IT manual and CD manual  
GB, IT, FR, DE, RU, ES, PT, BR.

- 33992 MINDRAY DP-50 EXPERT PORTABLE ULTRASOUND with 15" high resolution LCD monitor, 2 probe connectors, 500GB hard disk, 4 USB ports, multiple software package, without probes.
- Imaging mode:** B, B/B, 4B, B/M, M
- Image processing technology:**
  - Phase Shift Harmonic Imaging
  - Tissue Harmonic Imaging
  - iBeam™ Spatial Compound Imaging
  - iClear™ Adaptive Speckle Suppression Imaging
  - iTouch™ Auto Optimization
  - Trapezoid imaging
  - iZoom™ Automatically expand the image to full screen
  - Slant scanning for linear probes (2D Steer)
- Wideband multifrequency probes:** continuously adjustable 2-14 MHz
- Intelligent Workflow/Storage/Review:**
  - iStation™ Intelligent patient data management system
  - 320 GB integrated hard disk for storage
  - 4 USB ports
  - Cine memory capacity (Max.) B mode: 10566 frames
  - M mode: 66.3 s
- PW (Pulse Wave) and DICOM included**

TECHNICAL SPECIFICATIONS	
Display:	15" LCD
Display language:	GB, FR, IT, ES, PT, RU, PL, CZ, TR, FI, DK, NO, SE, DE
Power:	AC 100-240 V - 50/60 Hz rechargeable lithium-ion battery - on request
Size and weight:	DP-50 Expert 14.7x36.1x35.8 cm - 7.5 kg

# MINDRAY Z50 COLOUR DIAGNOSTIC ULTRASOUND SYSTEM

- 33881 MINDRAY Z50 COLOUR PORTABLE ULTRASOUND with 15" high resolution LCD monitor, 2 probe connectors, 500GB hard disk, 4 USB ports, multiple software package, without probes.

A colour doppler system that offers a rare combination of high performance and low cost. Superior image quality, affordability, versatility and mobility in a unique portable Doppler system.

**Versatility**

- scanning modes: B, Colour, PW, Power, M, FreeXros M
- image display modes: B, 2B, 4B, B/C, B/M, B/PW, Triplex PW
- applications: ABD/OB/GYN/CAR/SML/URO/VAS/ORTH/EM/NERVE
- transducer variety: Convex, Linear, Micro-convex, Endocavity
- extended scanning angle with ExFov function
- high frequency linear probe for superficial scanning

**Productivity**

- iTouch: quick image optimization with one-click
- iZoom: instant full screen zoom with one-click
- iStation: patient database review and analysis platform
- iStorage: direct data transfer to PC
- Clipboard: easy play, preview and sharing of cineloop
- Multiple image formats: BMP, JPG, DCM, AVI, DCM, CIN

**Mobility**

- compact and streamlined design weighing 8.1kg
- 15" LCD monitor with 60 degree tilt function

- dual universal transducer connectors
  - two level backlit keyboard for varying requirements
  - can be packed in a convenient hand-carried bag for easy transportation
  - 1.5 h uninterrupted scanning with rechargeable battery
- Supplied with CD manual:  
GB, FR, IT, ES, PT, DE, RU, BR.

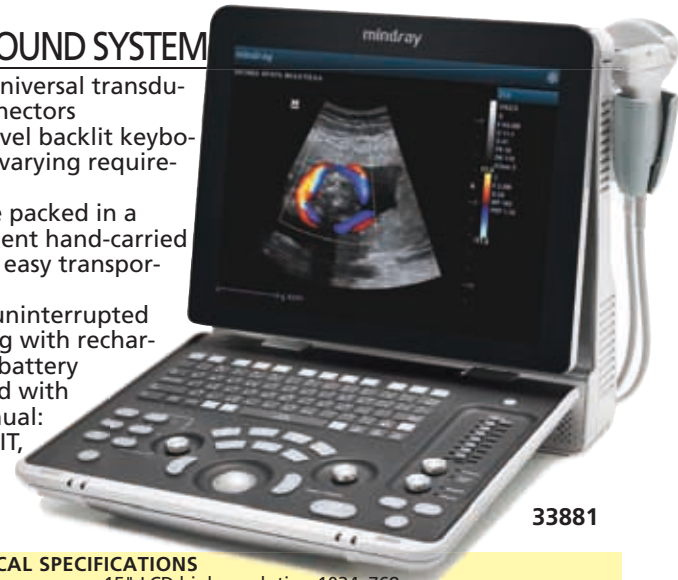

33881

TECHNICAL SPECIFICATIONS	
Display:	15" LCD high resolution 1024x768
Software display + keyboard input:	GB, FR, IT, ES, PT, RU, PL, CZ, DE
Keyboard input:	TR, FI, DK, NO, SE
Power:	AC 100-240 V - 50/60 Hz rechargeable lithium-ion battery - on request
Size and weight:	19x41.5x37.8 cm (7.5"x16.3"xh 14.9"); 8.1 kg without battery

# PROBES AND ACCESSORIES FOR DP-50, DP-50 EXPERT, Z5, Z50

GIMA code		ACCESSORIES for DP-50, DP-50 Expert, Z5, Z50	
33875	Needle guided brackets for Linear probe (33983)		
33876	Needle guided brackets for Micro-Convex probe (33984)		
33975	Lithium-ion rechargeable battery for DP-50, DP-50 Expert, Z5, Z50		
33987	Carrying bag for DP-50, DP-50 Expert, Z5, Z50		
33988	UMT-150 mobile trolley for DP-50, Z5		
33962	UMT-150 mobile trolley for DP-50 Expert, Z50		
33968	SONY PRINTER UP-X898 MD FOR DP-50, DP-50 Expert		
33993	SONY COLOUR PRINTER UP-25 MD FOR Z5, Z50		
33969	PW (Pulse Wave) doppler for DP-50 - optional		

PROBES DP-50, DP-50 expert, Z5, Z50			FREQUENCY (MHz)		● Main application									
GIMA code	Mindray code	Scanning method	Main freq.	Probe band width	ABDOMINAL	OB/GYN	UROLOGY	SMALL PARTS	CARDIOLOGY	MSK	VASCULAR	PEDIATRIC	PROSTATE	ORTHOPEDIC
33982	35C50EA	Convex	3.5	2.0 - 5.0	•	•	•	•	•	•	•	•	•	•
33983**	75L53EA	Linear	7.5	5.0 - 10.0	•	•	•	•	•	•	•	•	•	•
33978*	65C15EA	Micro-convex	6.5	5.0 - 8.5	•	•	•	•	•	•	•	•	•	•
33984*	65EC10EA	Micro-convex	6.5	5.0 - 8.5	•	•	•	•	•	•	•	•	•	•
33990*	10L24EA	Linear array	10.0	8.0 - 14	•	•	•	•	•	•	•	•	•	•
34004	75L38EA	Linear	7.5	5.0 - 10.0	•	•	•	•	•	•	•	•	•	•

\*Not for DP-50PT \*\*Not compatible for Z5, Z50



Trolley size:  
44,5x53,5x  
h 81 or 87 cm



Height selectable  
(2 levels) when  
installing

33988

# CHISON ECO2, ECO3EXP. DIGITAL ULTRASOUND SYSTEMS



**ECO2**  
33862

**ECO3EXP.**  
33864



**ECO2 Powerful and affordable B/W system**  
**ECO3EXP. Premium Black&White Model with Doppler,**  
 - ultra-compact and ultra-light weight, easy to carry  
 - latest LED screen technology, super bright images allow to easily view scan even outdoor  
 - ergonomic monitor design, 30 degree rotation, adjustable  
 - ultra-long battery life up to 2.5 hours, for outdoor scanning  
 - one-key to enlarge image to full screen, easy to view from distance  
 - streamlined workflow, easy to operate, 6-one-key to finish the cycle of diagnosis.

**Display modes and imaging processing**  
 B, B/B, 4B, M, B/M, PW multi-frequency imaging.  
**Imaging processing**  
 - compound Imaging - trapezoidal  
 - i-image intelligent image optimization - automatic PW trace  
 - THI (Tissue Harmonic Imaging) - Chroma  
 - SRA (Speckle Reduction Algorithm) - AIO (Automatic Image Optimization)  
 - full digital beam-former  
 - full screen display

**User interface**  
 - fold-up control panel and alphanumeric keyboard  
 - back-lit keyboard for good visibility in dark room  
 - indicator lights identify activated keys  
 - 8 TGC slides for easy adjustment  
 - short cut knob for quick adjustment (hot key user- defined)  
 - neat and clear keyboard layout, doctor can remember easily  
 - interactive back-lighting - user defined preset

**Streamlined workflow, one key to:**  
 - select desired application with automatic preset  
 - optimize the image automatically (AIO) - make report  
 - save still image and CINE loop - measure  
 - print to PC printer\* (laser or inkjet) or video printer  
 \*See list of compatible printers on our websites

**EASYVIEW™ Archive system**  
 - image archive on hard disk and USB mobile storage  
 - multiple image formats: BMP, JPG, DCM, CIN, AVI  
 - cine review: auto, manual (auto review segment can be set) for 2D, M, PW images  
 - cine memory capacity (256 frames/10s)  
 - 3 USB ports

**Norms**  
 IEC 60601-1, IEC 60601-1-1 Electrical medical equipment,  
 IEC 60601-1-2 Electromagnetic compatibility,  
 IEC 60601-1-4 Programmable medical systems,  
 IEC 60601-2-37

GIMA code	<b>DIGITAL ULTRASOUND B&amp;W DIAGNOSTIC IMAGING SYSTEM</b>
33862	CHISON ECO2 with 1 probe connector without probe
33864	CHISON ECO3EXP. with 2 probe connectors without probe

	ECO2	ECO3EXP.	ECO5/6
<b>STANDARD PACKAGE</b>			
12" high resolution LED monitor - B&W	•	•	
12" high resolution LED monitor - colour			•
8G memory card	•	•	•
Hot Key	•	•	•
PC printer connection	•	•	•
3 USB port, 1 ethernet port	•	•	•
1 video out port, 1 VGA out port, 1 footswitch port	•	•	•
Full screen display	•	•	•
2.5 hours rechargeable lithium-ion battery	optional	•	•
Power adaptor	•	•	•
Standard software package	•	•	•
Easy View image archive system	•	•	•
THI	•	•	•
PW (doppler function to detect blood flow speed)	•	•	•

<b>TECHNICAL SPECIFICATIONS</b>	
Dimension and weight:	33.5x15.5xh 35 cm (13.2"x6.1"xh 13.8"); 6 kg
Display:	12" LED, high resolution 1024x768
Power:	AC 100-240 V - 50/60 Hz
	rechargeable lithium-ion battery (ECO2 optional, ECO3EXP. standard)

<b>LANGUAGE - switchable by user</b>											
	GB	IT	FR	ES	PT	DE	PL	CZ	TR	CN	RU
Software	•	•	•	•	•	•	•	•	•	•	•
User manual	•	•									

## PROBES AND ACCESSORIES FOR CHISON ECO SERIES



PROBES ECO1 - 2 - 3 - 5 - 6				FREQUENCY(MHz)								Main application		
GIMA code	CHISON code	Scanning method	Main freq.	Probe band width	ABDOMINAL	OB&GYN	UROLOGY	SMALL PARTS	BASIC CARDIOL	CARDIOLOGY	MSK	VASCULAR	PEDIATRIC	ORTHOPAED.
33998	C3-A	Convex	3.5	2.5 - 5.0	•	•	•							
33999	L7M-A	Linear***	7.5	5.3 - 10.0				•			•	•	•	•
33871	L7S-A	Linear****	9.0	5.3 - 11.0				•			•	•	•	•
33872	V6-A	Micro-convex	6.0	4.5 - 8.0		•	•							
33997	MC6-A	Micro-convex	6.0	4.5 - 8.0	•									•
33873*	R7-A	Trans-rectal	7.5	5.0 - 10.0				•						
33874	MC3-A	Micro-convex	3.0	2.5 - 5.0	•			•	•					
33859**	P3-A	Phased Array	3.0	2.5 - 4.5						•				

\*For ECO3EXP., ECO5 and ECO6 only \*\*For ECO6 only  
 \*\*\*With 40 mm footprint, general linear probe  
 \*\*\*\*With 30 mm footprint for superficial tissue exams with higher resolution

GIMA code	<b>ECO SERIES ACCESSORIES</b>
33869	Rechargeable lithium-ion battery BT-2500 (2.5 hours)
33867	ECO trolley TR-9000
33868	Carrying bag
33866	Needle guided brackets - specify for which probe (for 33998-9 only)



<b>PRINTERS</b>	
33968	SONY UP-X898 MD B&W printer (for ECO1, ECO2 and ECO3EXP.)
33993	SONY UP25MD colour printer (for ECO5, ECO6)



# CHISON ECO5 AND ECO6 COLOUR DIGITAL ULTRASOUND SYSTEMS



- 33865 CHISON ECO5 Colour Doppler 12" high resolution LED monitor, 8G high speed memory, 3 USB ports, 2 probe connectors, EASYVIEW™ archive system, without probe
- 33858 CHISON ECO6 Colour Doppler 12" high resolution LED monitor, 8G high speed memory, 3 USB ports, 2 probe connectors, EASYVIEW™ archive system, without probe, with optional cardiac package, Super Needle, Auto IMT.

**Imaging modes:**  
 B, B/B, 4B, B/M, M, CFM, PW (ECO 5 and ECO6)  
 PD, DPD, B/BC, Triplex (only ECO6)

**Imaging processing:**

- MCI (Multiple Compound Imaging)
- i-image intelligent image optimization
- THI (Tissue Harmonic Imaging)
- SRA (Speckle Reduction Algorithm)
- full digital beam-former
- AIO (Automatic Image Optimization)
- trapezoidal
- Chroma
- full screen display mode
- automatic PW trace

**Other specifications as ECO3EXP.**



ECO5  
33865

## ECO6 EXCLUSIVE FEATURES

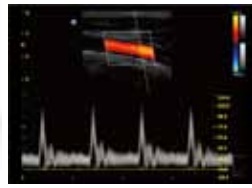

**Triplex - standard**  
 Triplex combines B, colour, with PW to help the user make diagnosis more convenient and accurate, improving efficiency.



ECO6  
33858

**Auto IMT Function - optional (code 33861)**  
 Automatically traces the intima and measures its thickness faster, more easily and more accurately.

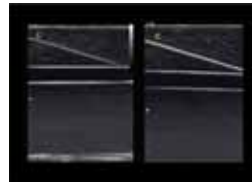

**Super Needle - optional (code 33860)**  
 With Super Needle, clinicians can see needle inside tissue more clearly during medical procedures. Needle angle up to ±30°.

**Continuous Wave (CW) Doppler - optional (code 33859)**  
 Detect blood flow with high velocity and help doctors diagnose with more clinical information.

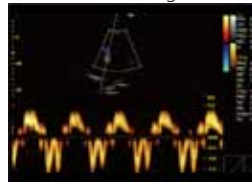

**Tissue Doppler Imaging (TDI) - optional (code 33859)**  
 New echocardiography technique that directly measures myocardial velocity. Systolic TD measurements assess left and right ventricular myocardial contractile function. Diastolic TD values reflect myocardial relaxation.

- 33859 CARDIAC PACKAGE: PROBE + CW + TDI - optional
  - 33860 SUPER NEEDLE - optional
  - 33861 AUTO IMT - optional
- ACCESSORIES AND PROBE** see page 341

	LANGUAGE - switchable by user										
	GB	IT	FR	ES	PT	DE	PL	CZ	TR	CN	RU
Software	•	•	•	•	•	•	•	•	•	•	•
User manual	•	•									•

TECHNICAL SPECIFICATIONS	
Size - weight:	33.5x15.5xh 35 cm (13.2"x6.1"xh 13.8") - 6.5 kg
Display:	12" LED, high-resolution colour 1024x768
Power:	AC 100-240 V, 50-60 Hz; Rechargeable Li-ion battery 14.8 V 4400 mAh

# CHISON QBit5 ECOCOLOURDOPPLER

- 33877 QBit5 ECOCOLOURDOPPLER - 15" flat high resolution LED monitor. Supplied with 2 probe connectors and 1 parking probe connector, trolley, keyboard, large image storage: 32 GB HardDisk, 6 USB ports, VGA format, without probes.
- Affordable and reliable colour doppler with advanced technologies: compound imaging, quad beam former imaging, Q-image, Q-flow, X-contrast providing superb images. The Streamlined workflow and ergonomic outlook design improve work efficiency.

**Imaging modes:**

- Power Doppler / Directional PD
- PW mode
- duplex, triplex
- chroma B/M/PW/CW
- trapezoidal on linear probe

**Imaging processing technology:**

- Speckle Reduction Algorithm (SRA)
- direct print to PC or video printer

**Imaging modes:**

- B/B/C
- CFM
- B/BC
- full screen
- B, 2B, 4B, B/M, M

*Four chambers view, B/BC mode*

GIMA code for QBit5	PROBES	FREQUENCY (MHz)		PROBE MODEL	Main application							
		Main freq.	Probe band width QBit5		ABDOMINAL	OB/GYN	UROLOGY	SMALL PARTS	CARDIOLOGY	TCD	PEDIATRICS	VESSELS
33953	CONVEX	3.5	2-6.8		•	•	•					
33878	LINEAR	7.5	4-15					•				•
33956	MICRO-CONVEX (TRANSVAGINAL)	6.0	4-12			•						
33964	MICRO CONVEX (BASIC CARDIAC)	3.0	2-6.8						•		•	
33879	CARDIAC (PHASED ARRAY)	2.5	1.5-5.3							•	•	
33958	PEDIATRIC	5.0	4-10.7									•

- Automatic Image Optimizaton (AIO)
  - Fusion Harmonic Imaging (FHI)
- Special radiology function:**  
 2D steer and super needle (optional)
- Phased array probe and package**  
 Phased array probe functions include CW, TDI, ECG, Colour M and complete calculation packages including PISA/Dp/Dt
- 33993 SONY UP - 25 MD COLOUR PRINTER A6 for i3, i8, QBit5
  - 33968 SONY UP-X898 B/W PRINTER for i3, i8, QBit5



CE 0197 FDA  
 15" LED monitor: rotatable -90° +90° foldable 0-90°

Size: 747x517x1283 mm  
 Net weight: 50 kg

33877

Two probe connectors

Hepatic vein, C mode

# SONOEYE: 4 DIGITAL COLOUR DOPPLER PALM ULTRASOUND SYSTEMS

SonoEye hand-held ultrasounds help healthcare professionals to provide high quality patient care in any location. SonoEye works exclusively connected to smartphones or pads.

Adaptable design, similar to a pad or mobile phone, increases its portability.

- light: half weight of a phone, less volume
- multiple devices: connection with smartphones or pads
- waterproof: IPX7, free cleaning and sterilization
- use anywhere: multiple fast solution
- thumb-play: one touch to start and finish the operation, easy to use.

SonoEye is intended for diagnostic ultrasound imaging in B (2D), B/M, CFM (Colour Flow Mapping), Combined (B+CFM), PW (Pulsed Wave) and Fusion Harmonic Imaging modes.

Available in 4 different models: **SonoEye P2 Linear Array** indicated for Small Organ, Musculoskeletal (MSK), Nerve, Lung, EM, Vascular.

**SonoEye P3 Phased Array** indicated for Abdominal, Cardiac, Lung, EM.

**SonoEye P5 Convex** indicated for Abdominal, OB/GYN, Urology, Lung, FAST, EM.

**SonoEye P6 Micro Convex** indicated for Abdominal, Cardiac, Urology, pediatric, OB/GYN and small parts.



Cable length 3m

93/42/EEC  
EN 60601-1  
Type BF  
continuous operation



Programmable buttons for customized functions: gain, depth, focus, freeze, save, .....

33916

**SONOEYE IS SUITABLE FOR HUMAN OR VET**

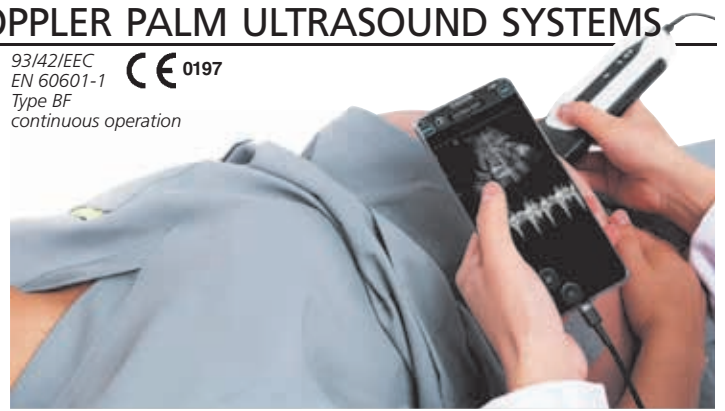

## IMAGING MODES



Basilar vein, C Mode

Cardiac, B Mode

Carotid, PW Mode



IV, B Mode

IVC, B Mode

Ulnar Nerve, B Mode

## SONOEYE PALM ULTRASOUND SYSTEM

GIMA code	Scanning Method	Frequency (MHz)		VASCULAR	MSK	NERVE	LUNG	ABDOMINAL OB/GYN	UROLOGY	SMALL PARTS	EM**	CARDIAC	FAST***
		Main freq.	Frequency range										
33914	P2 Linear	7.5	7-12	●	●	●	●				●	●	
33915	P3 Phased Array	3.0	2.5-4					●	●			●	●
33916	P5 Convex	3.5	3-5					●	●	●	●	●	●
33917	P6 Micro-Convex	6.5	4.0-8.0 FHI 6.0-10.0					●	●	●	●	●	●

## TABLET FOR SONOEYE

33918 Tablet for SonoEye

\*\*EM: Emergency medicine \*\*\* FAST: Focused assessment with sonography for trauma



Sonoeye carrying case



Light Half weight of a phone, highly integrated design, less volume.

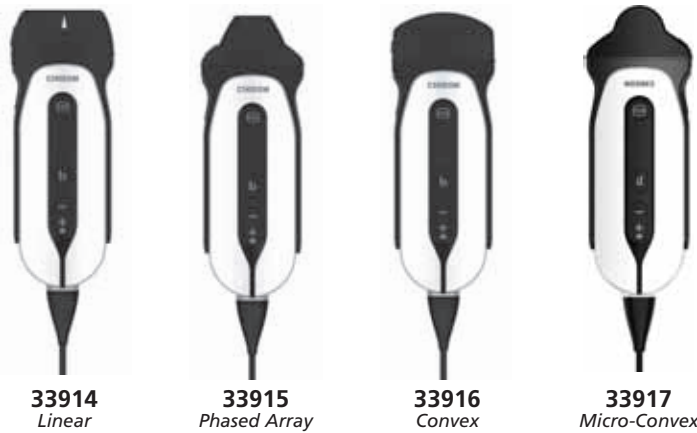

**App**  
SonoEye works with SonoEye App for Human or Vet, free to download on [www.chisonsonoeye.com](http://www.chisonsonoeye.com)  
**Human and Vet use**  
All SonoEye probes can be used on human or animals based on selected App.  
Supplied with carrying case and manual (GB, IT).

**CHISON**  
Value Beyond Imaging

Model	COMPATIBILITY			
Smart Phone:	RedmiNote 8Pro, HUAWEI P30 Pro, HUAWEI iV30			
Smart Pad:	HUAWEI Matepad Pro, Samsung Galaxy Tab A (SM-T510), TECLAST T30, Samsung GALAXY TAB S6, HONOR ViewPad V6, Canon SELPHY CP1300			

Model	33914	33915	33916	33917
Probe Type:	Linear	Phased Array	Convex	Micro-Convex
Central frequency:	7.5 MHz	3.0 MHz	3.5 MHz	6.5MHz
Frequency Range:	7.0-12.0 MHz	2.5-4.0 MHz	3.0-5.0 MHz	4.0-10.0 MHz
Scanning Depth:	1.0-14.8 cm	4.9-22.7 cm	3.8-37.3 cm	4.4-20.2 cm
Footprint*:	40 mm (43.5x9 mm)	18x12.5 mm	R50 (56.98x12.5 mm)	51.17x11 mm
FOV:	NA	90 degree	59 degree	93 degree
Doppler:	Support Mode: B+C, B/M, C mode, PW mode			
Image Optimal:	AIO (All others such as compound, i-IMAGE etc set by AIO)			
Dimensions mm:	64x170x24	64x173x24	64x172x24	64x174x24
Weight without cable:	130 g	124 g	143 g	138 g

\*Contact area of the probe to patient



Waterproof Hand-held ultrasound gives you the power to sterilize and clean freely.

# VIATOM WIRELESS HANDHELD ULTRASOUND SCANNERS



33931

**LINEAR**



33932

**LINEAR + CONVEX**



33934

**LINEAR + CONVEX + CARDIAC**

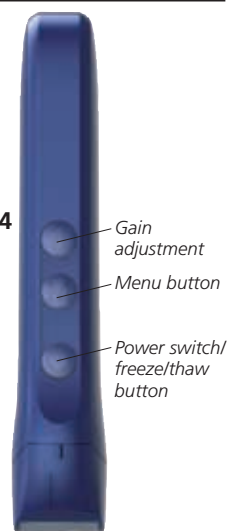

## WIRELESS HANDHELD ULTRASOUND SCANNERS

Easy to use wireless handheld ultrasound scanners. Medical staff can manage and share ultrasound scan results with patients through ultrasound software anytime, anywhere. Doctors can save cases and print reports with one click. High speed frames per second to get any small detail in maximum clarity for a quick diagnostic imaging.

- wireless connectivity, compatible with tablets and smartphones (iOS, Android)
- built-in and replaceable battery
- wireless charging support
- advanced digital imaging technology for clear images
- cost-effective and easy to carry
- suitable for hospital, emergency, clinic, outdoor
- intelligent terminal platform, powerful expansion functions on application, storage

### Dual head ultrasound scanner (33932)

Interchangeable linear and convex heads by simply flipping around the device.

### 3 in 1 ultrasound scanner (33934)

Linear + Convex + Phased Array (Cardiac) Probe, it can realize transition from shallow to deep scan without switching. Ultra-wide frequency coverage and scanning depth are suitable for whole body examination. Ultra-clear image and ultra-long standby  $\geq 12$ h with 4200 mAh. 3.7V super-large lithium battery. Built-in independent Wi-Fi module, which can realize delay-free image transmission without the external network, reduce data transmission delay and improve image clarity. Scanning parameters can be adjusted via a simple and intuitive

multi-touch interface: adjust depth, gain, power and color. All models have manual GB, IT.

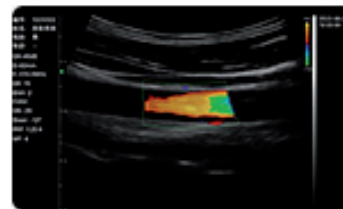

Carotid artery



Kidney

## VIATOM ULTRASOUND SYSTEM

GIMA code	Scanning Method	Frequency range (MHz)	VASCULAR	MSK	PEDIATRICS	BREAST	THYROID	CAROTID	SMALL ORGANS	LUNG	ABDOMEN	CARDIAC	GYNECOLOGY	OBSTETRICS	UROLOGY	KIDNEY	ARTERIES
33931	Linear	7.5-10	●	●	●	●	●	●	●								
33932	Linear	7.5-10	●	●	●	●	●	●	●								
	Convex	3.5-5								●	●	●	●	●	●	●	●
33934	Linear	7.5-10	●	●	●	●	●	●	●								
	Convex	3.5-5								●	●	●	●	●	●	●	●
	Cardiac	2.5-5	●									●					●

## STANDARD ACCESSORIES

	33931	33932	33934
Probe stand	●	●	
Wireless charging support	●	●	
USB cable			●
Charger adaptor			●
Carrying case			●

## MAIN USE OF ULTRASOUND PROBES

- Linear probe:** Suitable for the examination of superficial organs such as breast, thyroid, lymph nodes, etc. and blood vessels such as a carotid artery, upper extremity artery, lower extremity artery and other small organs, musculoskeletal examination.
- Convex probe:** Suitable for abdominal and pelvic organ scanning, FAST scanning, pleural effusion scanning and lung ultrasound scanning.
- Cardiac probe:** Suitable for cardiac ultrasonography of the heart, thoracic arteries and of intracranial blood vessels.



## TECHNICAL SPECIFICATIONS

Model	33931	33932	33934
Probe type:	Linear	Linear / Convex	Linear / Convex / Cardiac
Frequency range:	7.5-10 MHz	7.5-10 MHz / 3.5-5 MHz	7.5-10 MHz / 3.5-5 MHz / 2.5-5 MHz
Scanning depth:	20/40/60/100 mm	20/40/60/100 mm / 90/160/220/305 mm	20-80 mm / 90-305 mm / 90-160 mm
Head width:	40 mm	40 mm / 45 mm	60 mm
Doppler:	B, BM	B, B/M, B+colour, B+PDI, B+PW	B/BM/Colour/PDI/PW
Battery life:	3-5 hours	$\geq 2.5$ hours	3 hours
Charging time:		2 hours	3 hours
Size:		15.6x6x2 cm	15.7x7x3 cm
Weight:	230 g	260 g	220-250 g
Image Measure:	Length, Area, Angle, Heart Rate, Obstetrics		Distance, Area, Circumference, Angle, Heart Rate, Time, Velocity, S/D, Depth-1
Format:	JPG, AVI, DICOM		JPG, PNG, AVI, MP4, DICOM
Frame rate:	18 frames/second		31 frames/second
Image adjust.:	BGain, TGC, DYN, Focus, Depth, Harmonic, Denoise		

# GIMA 900 PRO AND PLUS VITAL SIGNS MONITORS

- 35124 GIMA 900 PRO VITAL SIGNS MONITOR
- 35132 GIMA 900 PLUS VITAL SIGNS MONITOR

"Vital Signs" is a line of small multi-parameter patient monitors, which can monitor the vital physiological parameters: non-invasive blood pressure (NIBP), pulse oxygen saturation (SpO<sub>2</sub>), electrocardiogram (ECG) and temperature (TEMP).

- 3.5" LCD display for remote review (GIMA-900 Pro), and 7" high resolution touch screen (GIMA-900 Plus)
- history data records reviewed in waveform, list and trend graph
- USB connection for data output and software upgrade

GIMA code	ACCESSORIES AND SPARES	
35133	Printer*- optional	<i>*Installation done by Gima if ordered with monitor. Need service if ordered later.</i>
35141	Paper 5.1 cm x 12 m	- box of 5
35129	Lithium re-chargeable battery	- spare for 35124, 35132
35135	Reusable adult SpO <sub>2</sub> probe	- spare
35136	Reusable pediatric SpO <sub>2</sub> probe	
35137	5 leads ECG cable	- spare
35127	Trolley - adjustable 73 to 113 cm	
35128	Rail clamp	
For 900 Pro	For 900 Plus	NIBP CUFF
35140	35050	NIBP cuff - 10-19 cm - pediatric
35142	35051	NIBP cuff - 18-26 cm - pediatric XL
35139	35052	NIBP cuff - 21-35 cm - adult
35143	35053	NIBP cuff - 27-42 cm - adult XL

- STANDARD ACCESSORIES**
- Adult SpO<sub>2</sub> probe
  - NIBP adult cuff
  - Temperature probe - skin type
  - ECG cable + 10 ECG electrode
  - Lithium rechargeable battery
  - Power supply cable
  - Dust protective mantle
  - Manual (GB, FR, IT, ES)



**TECHNICAL SPECIFICATIONS**

<b>NIBP</b>	Measuring method: Oscillometric	Measuring accuracy: ±2 bpm or ±2%, whichever is greater	
	Measurement mode: Manual, Auto, STAT		
	Measurement range:		
Press(unit)	Adult	Pediatric	Neonate
SYS mmHg	40-275	40-200	40-135
MAP mmHg	20-230	20-165	20-110
DIA mmHg	10-210	10-150	10-95
<b>SpO<sub>2</sub></b>	Measuring range: 35%~100%		
	Measuring accuracy: 3% for range from 70 to 100%		
	Low perfusion performance: as low as 0.4%		
<b>Pulse Rate</b>	Measuring range: 30~240 bpm		
		<b>ECG</b>	HR display range: 15~350 bpm
			HR display accuracy: ±1% or ±2 bpm, whichever is greater
			HR alarm delay time: ≤10s
			Sensitivity selection: x1/4, x1/2, x1, x2
			Sweeping speed: 25 mm/s
		<b>Temperature</b>	Measuring range: 21-50°C
			Measuring accuracy: ±0.2°C for range 25-45°C
		<b>Other Technical Specifications</b>	Power supply: 100~240 VAC, 50/60 Hz
			Battery: 11.1 V / 4,400 mAh (Li-ion Battery)
			Size: 168x172xh 242 mm

# PC-3000 MULTI-PARAMETER PATIENT MONITOR



- 35134 PC 3000 MULTI-PARAMETER PATIENT MONITOR
- 7" high resolution colour TFT display, 5-channel waveform display
- standard parameters: ECG, RESP, SpO<sub>2</sub>, NIBP, TEMP, PR; Arrhythmia analysis and ST segment analysis
- up to 12,000 groups parameter data & 60-hour ECG waveform storage and recall
- 1,000-hour graphic and tabular trends for all parameters
- 7-channel ECG simultaneous waveforms display
- protection against interference from defibrillator, electrosurgical knife
- adult / pediatric measurement modes
- visual and audible alarms;
- carrying handle with bed-hooks
- Internal software: GB, IT, FR, ES, PT, PL, CZ, TR, CN.

**STANDARD ACCESSORIES**

1 ECG cable	1 NIBP cuff	10 Disposable electrodes
1 Adult SpO <sub>2</sub> probe	1 Li-ion battery*	1 Body surface temperature transducer
1 AC power Adapter	1 Power cable	User manual: IT, GB, FR

\*About 3 hours continuous working when battery is fully charged

GIMA code	ACCESSORIES - SPARES
35135	Adult SpO <sub>2</sub> probe - spare
35136	Pediatric SpO <sub>2</sub> probe
35137	5 leads ECG cable - spare
35138	Li-ion battery - spare
35140	NIBP cuff 10-19 cm - pediatric
35142	NIBP cuff 18-26 cm - pediatric XL
35139	NIBP cuff 21-35 cm - adult - spare
35143	NIBP cuff 27-42 cm - adult XL
35144	Carrying bag
35160	AC power adapter + cable - spare
35163	Carrying handle - spare

**TECHNICAL SPECIFICATIONS**

<b>NIBP Monitoring</b>	Measuring method: Automatic measurement by oscillating method	
	Initial cuff inflation pressure: Adult mode: <180mmHg	Infant mode: <120mmHg
	Overpressure protection limit: Adult mode: 300mmHg	Infant mode: 240 mmHg
	<b>Measuring range</b>	
Systolic pressure:	Adult: 40-225 mmHg	Infant: 40-200 mmHg
Diastolic pressure:	Adult: 20-215 mmHg	Infant: 20-165 mmHg
Mean arterial pressure:	Adult: 10-195 mmHg	Infant: 10-150 mmHg
Measurement accuracy:	Systolic ±10%	Diastolic ±10% MAP ±10%
Measurement mode:	Manual, Auto, STAT	
Automatic measuring:	1-240min	
<b>TEMP Monitoring</b>	Measuring range, accuracy: 21.0 - 50.0 °C, ±0.2°C	
<b>SpO<sub>2</sub> &amp; Pulse Rate Monitoring</b>	Transducer: dual-wave length LED	
	SpO <sub>2</sub> measuring range: 0 - 100 %	
	Accuracy: 70%-100% ±3%	
	Low perfusion capability: 0.4 - 5 %	
PR measuring range:	0 - 250 bpm ±2 bpm	
<b>ECG Monitoring</b>	Heart rate measurement: ±0.4 mVp - ±5 mVp	
	Heart rate display range: 15 - 350 bpm ±1% or ±2 bpm whichever is greater	
	Heart rate alarm delay time: ≤10s	
	Sensitivity selection: Auto, x1/4, x1/2, x1, x2, x4	tolerance: ≤5%
	Sweeping speed: 12.5 mm/s, 25 mm/s, 50 mm/s	tolerance: ≤10%
	Common-mode rejection ratio: ≥89 dB	
	Frequency response mode: Monitoring: 0.5 - 40 Hz	Diagnostic: 0.05 - 75 Hz
<b>RESP Monitoring</b>	Monitoring range, accuracy: 0 - 120 rpm, ±5% or 2 rpm, whichever is greater	
	RESP alarm range: 0 - 100 bpm ±10%	
<b>Other Technical Specifications</b>	Power supply: 100 - 240 Vac, 50/60 Hz - 60 VA	
	Networking port: serial/Net port	
<b>Norms</b>	IEC 60601-1 Class I, type BF, IPX2	



Wide option of screen views available

# UP 7000 MULTI-PARAMETER PATIENT MONITOR

ECG+RESP+SpO<sub>2</sub>+  
2 TEMP+PR+NIBP  
optional EtCO<sub>2</sub>

Size:  
29x31.5x15 cm  
Weight:  
3.9 kg

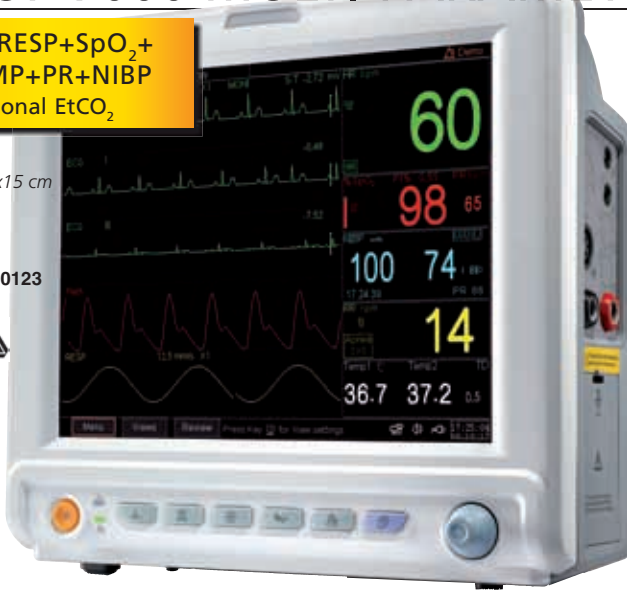

- **35145 MULTI-PARAMETER PATIENT MONITOR**  
ECG, RESP, SpO<sub>2</sub>, 2 TEMP, PR, NIBP with printer
- 12.1" high resolution colour TFT display with LED backlight
- 3 channel ECG amplification
- arrhythmia analysis and ST segment analysis
- up to 2,000 groups parameter data & 24-hour ECG waveform storage and recall
- 2,000-hour graphic and tabular trends for all parameters
- 9 trace ECG waveforms simultaneous display
- protection against interference from defibrillator
- adult/pediatric/neonate measurement modes
- visual and audible alarms
- built-in rechargeable lithium battery
- built-in thermal printer
- multilingual internal software: GB, FR, IT, ES, PT, PL, TR, RU, CN

GIMA code	ACCESSORIES AND SPARES
33796	Respironics LoFlo EtCO <sub>2</sub> Sidestream sensor
33797	Respironics Capnostat EtCO <sub>2</sub> Mainstream sensor
35135	Adult SpO <sub>2</sub> probe - spare
35136	Pediatric SpO <sub>2</sub> probe - optional
35137	ECG cable - spare
35140	NIBP cuff - arm circumf. 10-19 cm - pediatric
35142	NIBP cuff - arm circumf. 18-26 cm - pediatric XL
35139	NIBP cuff - arm circumf. 21-35 cm - adult
35143	NIBP cuff - arm circumf. 27-42 cm - adult XL
35141	Paper 5.1 cm x 12 m - box of 5
35148	Trolley - adjustable 73 to 113 cm
35129	Lithium rechargeable battery - since S.N. J3300PG00766



STANDARD ACCESSORIES		
- Adult SpO <sub>2</sub> probe	- Re-chargeable battery	- Disposable electrode
- NIBP adult cuff	- Printer	- Dust-protective mantle
- Temperature probe - skin	- Power supply cable	- Manual (GB, IT)
- ECG cable 5 leads (RA - LA - LL - PL - C)		

TECHNICAL SPECIFICATIONS			
<b>NIBP Monitoring - Oscillometric</b>			
Measuring range:	Systolic pressure:	Diastolic pressure:	Mean arterial pressure:
adult:	40~275mmHg	10~210mmHg	20~230mmHg
pediatric:	40~200mmHg	10~150mmHg	20~165mmHg
neonatal:	40~135mmHg	10~95mmHg	20~110mmHg

<b>TEMP Monitoring</b>	
Measuring range:	21.0°C~50.0°C ±0.2°C
Response time:	≤ 150 sec
<b>SpO<sub>2</sub> &amp; Pulse Rate Monitoring</b>	
Input dynamic range:	0%~100%
PR measuring range:	0bpm~250bpm
<b>ECG Monitoring</b>	
Input dynamic range:	±0.5mVp~±5mVp
HR measuring range:	15bpm~350bpm
<b>RESP Monitoring</b>	
Measuring method:	Thoracic impedance
Monitoring range:	0rpm~120rpm, ±5% or ±2rpm whichever is greater
<b>Other Technical Specifications</b>	
Power supply:	100~240Vac, 50/60Hz
Power consumption:	<80 VA
Alarming mode:	Audible-visual alarm
Networking port:	Ethernet port

# NEW CMS 8000 CONTEC PATIENT MONITOR

ECG+RESP+SpO<sub>2</sub>+  
NIBP+2 TEMP+PR  
optional EtCO<sub>2</sub>

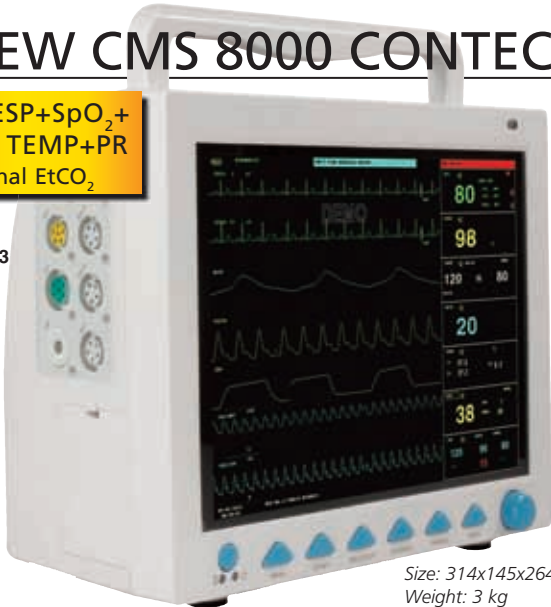

Size: 314x145x264 mm  
Weight: 3 kg

- **35152 NEW CMS 8000 PATIENT MONITOR**  
ECG, RESP, SpO<sub>2</sub>, PR, NIBP, DUAL CHANNEL TEMP
- 12.1" TFT colour LCD display
- multilingual interface (GB, IT, FR, DE, ES, PT, NL, PL, CZ, TR, RO, RU)
- adult/pediatric/neonate measurement modes
- 8 channel waveform synchronous display
- 7 lead ECG waveform on one screen
- anti-motion, anti-ambient light interference digital SpO<sub>2</sub> technology
- AC/DC rechargeable lithium battery
- manual/AUTO/continuous NIBP measurement mode
- standard/OXY- graph/Trend-graph/big characters and view bed interfaces

For new	For old	ACCESSORIES AND SPARES
35152	35151	
33796	33796	Respironics LoFlo EtCO <sub>2</sub> Sidestream sensor
33797	33797	Respironics Capnostat EtCO <sub>2</sub> Mainstream sensor
35153	35149	Adult SpO <sub>2</sub> probe - 3 m cable - spare
35107	35107	Neonate SpO <sub>2</sub> probe <3 kg - reusable
35104	35108	SpO <sub>2</sub> extension cable
35113	35113	Pediatric NIBP cuff 18-26 cm
35146	35114	Adult NIBP cuff 25-35 cm - spare
35147	35115	Adult large NIBP cuff 33-47 cm
35116	35116	Thigh NIBP cuff 46-66 cm
35181	35154	Rectal temp probe - optional
35182	35155	Skin temp probe - spare
35183	35156	ECG cable - spare
35157	35157	Printer - optional*
35158	35158	Trolley
35161	35159	Rechargeable lithium battery - spare
32968	32968	Printer paper roll 50 mm x 20 m



\*Installation done by Gima if ordered with monitor. Need service if ordered later.

STANDARD ACCESSORIES		
- Adult SpO <sub>2</sub> probe	- Rechargeable lithium battery	
- NIBP adult cuff and extension tube	- ECG cable	- manual: GB, IT
- Temperature probe - skin	- power supply cable	- ECG electrodes

TECHNICAL SPECIFICATIONS	
<b>ECG</b>	Measurement period in CONT mode: 5 min
5-lead, dual channel, 3-lead, single channel	Measurement alarm: 10-270 mmHg
Scan speed: 12.5 mm/s, 50 mm/s	<b>SpO<sub>2</sub></b>
ST segment monitoring	Measurement and alarm range: 0-100%
Measurement and alarm range: -2.0 mV ±2.0 mV	Measurement accuracy: 70-100% ±2%
<b>RESP</b>	<b>PR</b>
Method: R-F (RA-LL) impedance	Measurement and alarm range: 25-250 bpm
Measurement and alarm range: 0-150 rpm	<b>TEMP</b>
Apnea alarm: 10-40 sec	Channel: dual channel
<b>NIBP - Oscillometric method</b>	Measurement and alarm range: 0-50 °C
Mode: manual/AUTO/continuous	Power supply: 100-240 V - 50/60 Hz
Measurement interval in AUTO mode:	Safety classification: Classe I type CF
1/2/3/4/5/10/15/30/60/90/120/240/480/960 min	Defibrillation-proof applied part

# K12 AND K15 PATIENT MONITORS FOR INTENSIVE CARE

- 35306 K12 MULTIPARAMETER MONITOR 12"
- 35307 K12 TOUCHSCREEN MULTIPARAMETER MONITOR 12"
- 35309 K15 TOUCHSCREEN MULTIPARAMETER MONITOR 15"
- 35310 K15 TOUCHSCREEN 2 IBP+ EtCO<sub>2</sub> MULTIPARAMETER MONITOR 15"

Multi-functional patient monitors for monitoring the vital physiological signs of adult, pediatric and neonate patients. Real-time recording and displaying of parameters, such as ECG, heart rate (HR), non-invasive blood pressure (NIBP), oxygen saturation (SpO<sub>2</sub>), respiration (RESP) and temperature (TEMP) allow comprehensive analysis of patient's physiological conditions.

- ergonomic design with intuitive user interface
- USB socket for data transfer and software upgrade
- 9 traces on-screen waveforms
- Windows style display view, easy to operate
- visual and audible alarm for physiological and technical alarms
- large capacity storage
- suitable for use with original Nellcor sensors
- protection against defibrillator discharge, resistance against the interference from electro-surgical unit; Cardiac pacemaker pulse detection and inhibition.

Internal software: GB, DE, FR, PT, ES, IT, PL, TR, RU.  
PC software only GB. Compatible with Windows XP, 7, 8, 10.

GIMA code	ACCESSORIES FOR K12, K15
35133	Printer** - optional
35141	Paper 5.1 cm x 12 m - box of 5
35311	NIBP cuff - 6x11 cm neonate - optional
35312	NIBP cuff - 10x19 cm pediatric - optional
35313	NIBP cuff - 21x35 cm adult - spare
35314	SpO <sub>2</sub> rubber probe*** D type - adult - opt. - need ext. cable
35315	Reusable SpO <sub>2</sub> probe*** D type - neonate - opt. - need ext. cable
35316	Reusable SpO <sub>2</sub> probe*** D type - pediatric - opt. - need ext. cable
35317	Reusable SpO <sub>2</sub> probe*** D type - adult - spare - need ext. cable
	***Nellcor compatible
35318	Extension cable for SpO <sub>2</sub> probes - spare
	See disposable Nellcor compatible SpO <sub>2</sub> sensors - page 351
	Respironic Mainstream (33797) and Sidestream (33796) CO <sub>2</sub> sensors - page 350
35319	Rechargeable lithium battery - spare
35320	ECG cable - spare
35148	Trolley - optional
35321	IBP**** single use monitoring kit for 35310 - spare

\*\*\*\*Invasive Blood Pressure (IBP) is a direct measurement of the patient's arterial or venous blood pressure. Catheter is inserted directly into a vein, artery or other pressure access areas and connected to a pressure transducer for measuring systolic, diastolic and mean blood pressures. The monitor can display data and a waveform for each pressure channel.

TECHNICAL SPECIFICATIONS	
<b>ECG</b>	
Input dynamic range:	±(0.5-5 mVp)
Differential input impedance:	≥10 MΩ
Bandwidth:	0.05-150 Hz (Diagnostic) 0.5-40 Hz (Monitoring) 1-20 Hz (Operation)
<b>CMRR:</b>	≥90 dB (Diagnostic) ≥105 dB (Monitoring & Operation)
Sensitivity selection:	x1/4, x1/2, x1, x2, x4 and Auto
Sweeping speed:	6.25 mm/s, 12.5 mm/s, 25 mm/s, 50 mm/s
HR measuring range:	15-350 bpm ±1% or ±2 bpm, whichever is greater
Pacemaker pulse detection and rejection function	
<b>RESP</b>	
Measuring range:	0-120 rpm ±5% or ±2 rpm, whichever is greater
<b>TEMP</b>	
Measuring range:	21.0-50.0 °C ±0.2 °C from 25-45 °C
<b>NIBP</b>	
Technique:	Oscillometric method
Typical measurement time:	<30 seconds (adult cuff)
NIBP measuring range:	SYS: 40-275 mmHg (Adult) 40-200 mmHg (Pediatric) 40-135 mmHg (Neonate)
NIBP measuring range:	DIA: 10-210 mmHg (Adult) 10-150 mmHg (Pediatric) 10-95 mmHg (Neonate)
NIBP measuring range:	MAP: 20-230 mmHg (Adult) 20-165 mmHg (Pediatric) 20-110 mmHg (Neonate)
NIBP measuring accuracy:	Mean difference: ±5 mmHg Standard deviation: 8 mmHg Manual, Auto, STAT, Multi-cycle mode 1-480 min
NIBP measurement mode:	
Auto measuring intervals:	
SpO <sub>2</sub> Technique:	Dual-wavelength optical method
Measuring range:	0%-100% ±2% for SpO <sub>2</sub> , range 70-100%
PR measuring range:	30-250bpm ±2bpm or ±2%, whichever is greater
Low perfusion performance:	As low as 0.3%.
EtCO <sub>2</sub> (only for 35310, needs 33796 or 33797)	
Technique:	Infrared optical method
Sampling mode:	Sidestream or Mainstream
Measuring range:	0-150 mmHg
Measuring accuracy:	0-40 mmHg ±2 mmHg; 41-70 mmHg ±5%; 71-100 mmHg ±8%; 101-150 mmHg ±10%; 50 ml/min ±10 ml/min (Sidestream)
Flow rate:	
IBP - 35310 only	
Technique:	Strain gauge transducer
Input sensitivity:	5 μV/V/mmHg
Measuring range:	-50-300 mmHg ±2% or ±4 mmHg, whichever is greater
Measuring positions:	ART, RAP, PA, LAP, CVP, ICP, AUXP1, AUXP2
Calibration:	zero calibrating
<b>Other Specifications</b>	
Power supply:	AC 100-240 V, 50/60 Hz, 60 VA
Built-in lithium battery:	11.1V/4400 mAh
Display:	12 or 15 inch TFT display
Alarming method:	3 levels audible-visible alarm
Networking:	Ethernet
Safety standard:	IEC 60601-1

15" display with LED backlight 9 waveform on screen

ECG + SpO<sub>2</sub> + NIBP + RESP + 2-TEMP  
2 IBP\* + EtCO<sub>2</sub>\* configuration

\*Only for 35310

360° degree visible indicator with 3 level alarm

Lithium battery up to 2.5 hours continuous monitoring

Optional printer, code 35133

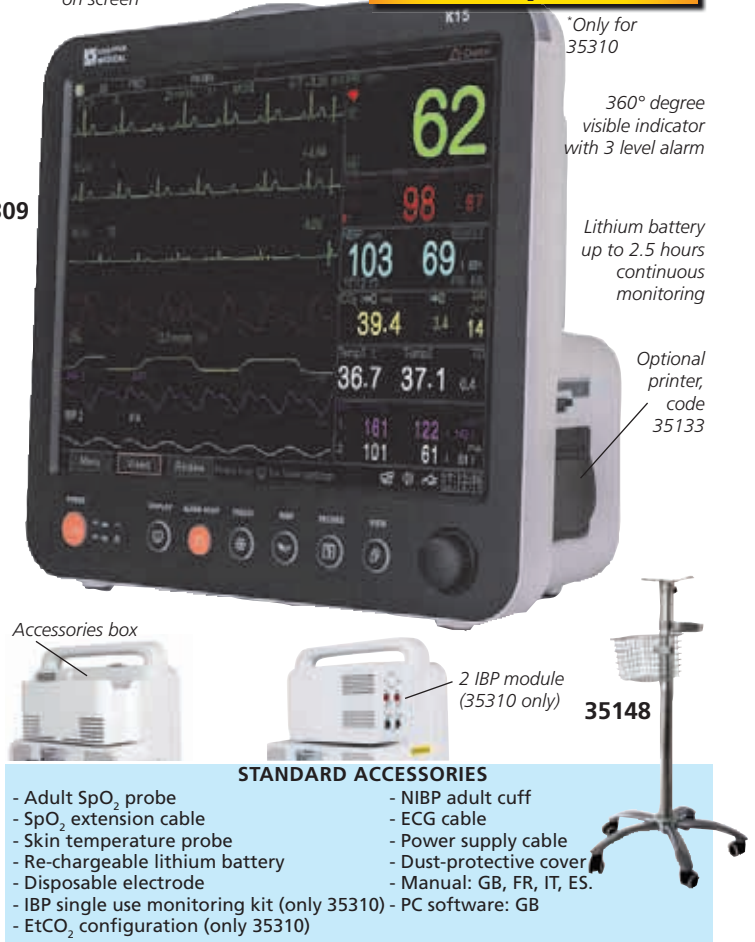

Accessories box

2 IBP module (35310 only)

35148

### STANDARD ACCESSORIES

- Adult SpO<sub>2</sub> probe
- SpO<sub>2</sub> extension cable
- Skin temperature probe
- Re-chargeable lithium battery
- Disposable electrode
- IBP single use monitoring kit (only 35310)
- EtCO<sub>2</sub> configuration (only 35310)
- NIBP adult cuff
- ECG cable
- Power supply cable
- Dust-protective cover
- Manual: GB, FR, IT, ES.
- PC software: GB

# PATIENT CENTRAL STATION UP TO 64 MONITORS FOR UP7000\*, K12, K15

- 35323 CENTRAL STATION SOFTWARE  
Software collects all data of each bedside monitor and displays them in a collective way. It stores, monitors and analyses the trend data of ECG and other parameters. It can manage up to 64 bed monitors. It includes Soft-key, CD Software, 2 meters networking cable.
- 33745 CENTRAL STATION SYSTEM PC+MONITOR

- 33746 LAN CABLE - 3 m
- 33767 LAN CABLE - 30 m  
One cable for any monitor to be connected. Customized cable length on request. Manual in: GB, IT.  
\*Since S.N. J3300PG00766

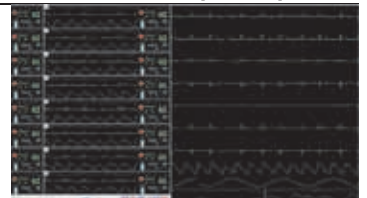



# RIESTER RVS-100 VITAL SIGNS MONITOR



Intuitive user interface with highly responsive touch screen



"Early Warning Scores" view mode



Programmable with EWS: NEWS, MEWS and 5 customisable profiles.



33801

## MULTIPARAMETER MONITORS

- 33800 RVS-100 NIBP + SpO<sub>2</sub> + PRINTER
- 33801 RVS-100 NIBP + SpO<sub>2</sub> + PRED. TEMP + PRINTER

The Riester RVS-100 is an easy to use vital signs monitor with touchscreen display, offering pulse oximetry, blood pressure. Temperature measurements (only 33801). Meeting your healthcare system's needs, offering spot check, triage, and continuous monitoring modes for all neonatal to adult patients.

### Key Features

- 3 measurement modes (Monitor, Spot-check, Triage)
- high-sensitivity 8" TFT colour touch screen with self-explanatory user interface and integrated help-function
- displays SYS, DIA, MAP, Pulse, Temp, Plethysmogram
- EWS, NEWS and MEWS for early detection to improve patient outcomes
- clinical grade NIBP including averaging mode (2-5 readings) and neonate mode
- Bluetooth connectivity to Riester 'tymPRO' and 'sensoPRO' thermometers
- Riester Oximax SpO<sub>2</sub> including neonate mode
- predictive oral Thermometer (Filac 3000), only 33801
- connectivity with the EMR - using the HL7 standard
- LAN Connectivity as standard

- programmable alarms (audible, visible) with 3 priority levels
- supports nurse call RJ11 port
- internal memory for 5,000 measurements
- internal software language: GB, FR, IT, ES, PT, DE, DK, PL, CH
- lithium-ion battery with 11 hours run time (Automatic mode, 15 min intervals)

33801 + 33810

Basket (270x200x225 mm) for cuffs, sensors, cables storage



GIMA code	RIESTER code	ACCESSORIES FOR RVS-100
33805	13301	Riester SpO <sub>2</sub> sensor - children - optional
33806	13302	Riester SpO <sub>2</sub> sensor - adult - spare
33813	129.006	Riester pediatric velcro cuff 35.5 x 10 cm - optional
33810	13317	Trolley with basket
33811	13321	Printer paper roll 4.9 cm x 30 m - box of 20

### STANDARD ACCESSORIES

SpO <sub>2</sub> adult sensor	2 cuffs (adult and adult large with connectors)
SpO <sub>2</sub> extension cable	Lithium battery and charger
Oral temperature probe (only 33801)	Manual (GB, IT. On request FR, DE, ES, PT, PL)
Probe covers (only 33801)	
NIBP extension tube	

### TECHNICAL SPECIFICATIONS

#### Clinical-grade NIBP (non-invasive blood pressure)

Measuring method:	automatic oscillometric		
Measurement range:	SYS	DIA	MAP
	Adult 30-270 mmHg	10-220 mmHg	20-235 mmHg
	Pediatric 30-235 mmHg	10-220 mmHg	20-225 mmHg
	Neonate 30-135 mmHg	10-110 mmHg	20-125 mmHg
Cuff pressure range:	0-280 mmHg, resolution 1 mmHg		
Pressure accuracy:	Static ±3 mmHg Clinic ±5 mmHg, standard deviation ≤ 8 mmHg		
Pulse rate range:	40-240 bpm, accuracy 1 bpm		
Initial inflation pressure:	Adult	Pediatric	Neonate
	160 mmHg	130 mmHg	75 mmHg
	Double overpressure protection (hardware and software)		
	297 ± 3 mmHg	252 ± 3 mmHg	147 ± 3 mmHg
Alarm range:	SYS, DIA, MAP 0 - 300 mmHg		

#### Riester SpO<sub>2</sub>

Measurement range:	0-100 %, resolution 1%
Accuracy:	±2% (70 to 100%) - ±3% (40 to 69%) Unspecified (0 % to 39 %)
Alarm range:	0-100 %
Average time:	4 sec, 8 sec, 16 sec

#### Pulse rate

Measurement range:	20-250 bpm, resolution 1 bpm
Accuracy:	±1 % or ± 1 bpm whichever is greater

#### Predictive thermometer (only 33801)

Oral (Quick Mode)	non-fever temps: 3 - 5 seconds
-------------------	--------------------------------

Oral (Standard Mode):	fever temps: 8 - 10 seconds
Measurement accuracy:	6-10 seconds 35.5 - 42°C ± 0.1°C (± 0.2°F)
Monitor Alarm:	Visible LEDs (Red, Yellow, Cyan) Audible Speaker Audible alarm, QRS tone Supports Pitch Tone and multi-level volume Alarm tones meet the requirement of IEC 60601-1-8 Pressure: 45 to 85 dB test distance 1 meter from the tone
Ports:	1 AC power inlet 1 standard RJ45 interfaces.100 BASE-TX, IEEE 802.3 4 USB ports 1 Equipotential grounding point 1 RJ11 connector for nurse call DC out port 15V/1.2 A
Power Supply:	100 - 240 V AC, 50/60 Hz
Battery:	Lithium-Ion, rechargeable battery, 10.8 V DC, 6,600 mAh, Charging time to a 100%: 6 hours Operating time approx. 11 hours (new and fully charged battery with connected SpO <sub>2</sub> , Temp and NIBP on AUTO mode (15 minutes interval)) Low battery indicator and charging battery indicator
Monitor dimensions:	303x110x h 230 mm (11.93x9.05x4.33 inches)
Weight:	3600 g, (7.94 lb) including temp module, printer

# BM3 PRO MULTIPARAMETER MONITOR WITH TOUCH SCREEN

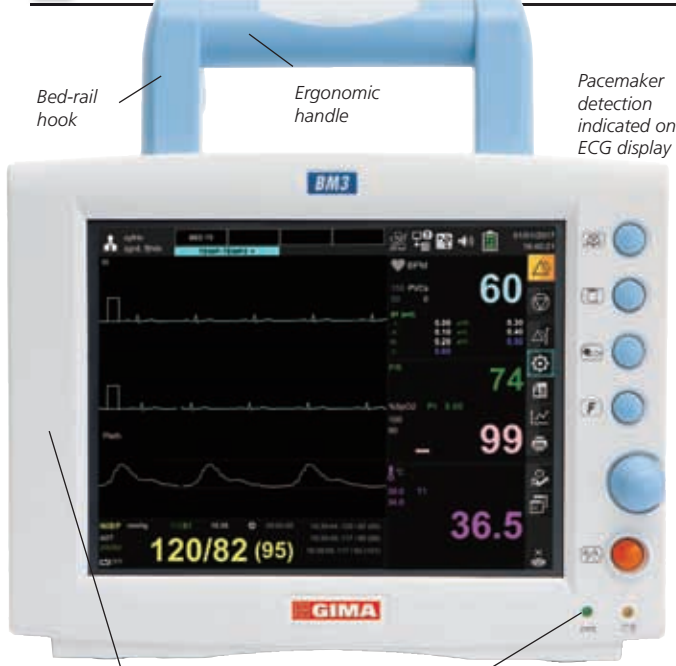

Bed-rail hook  
Ergonomic handle

Pacemaker detection indicated on ECG display

58 mm built-in printer for both real time and trend data (Speeds: 25-50 mm/sec)

Battery status indicator - continuous operating time approx 2 h

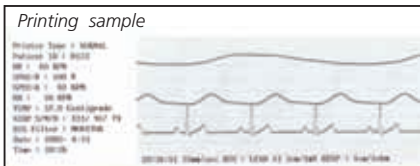

Easy mounting with bed-rail hook

ECG+SpO<sub>2</sub>+NIBP+RESP+ optional TEMP and EtCO<sub>2</sub>



ST analysis display mode

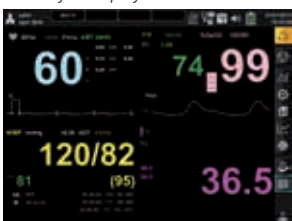

Large parameter display mode



Trend display mode

## • 33720 GIMA BM3 PRO TOUCH MONITOR (8" - 800x600 - TFT display)

- GIMA monitor is configured with:
- 8" wide colour touch screen TFT LCD for a clear view
  - Individual sweep speed setting for each parameter
  - 168 full hours trend data stored
  - SpO<sub>2</sub> measurement with very low perfusion detection and pulse beep
  - 2 traces ECG
  - screen freeze on/off
  - external HDMI output for large screen
  - connection to Central monitoring system using LAN or W-LAN
  - Li-ion Battery (for 2 hours continuous operation)
  - High-performance ECG detection and analysis
    - input impedance for dry skin or electrode patch
    - ST level, PVC count real-time display
    - 13 kinds of Arrhythmia analysis
    - pacemaker detection function
  - Enhanced & extendible multi-parameter
    - Sidestream/Mainstream EtCO<sub>2</sub>
  - Enhanced data management
    - graphical and tabular trends
    - 20 cases per 10 sec alarm waveform stored, reviewed and printed
  - USB memory storage
  - B2B interconnection
    - up to 4 monitors (BM3/5/7) can be connected
  - Internal software selectable in GB, DE, FR, IT, PT, PL, RO, HU, ES, CZ, BG, RU, TR, CN
  - User manual: GB, IT (on request: ES, FR, DE).

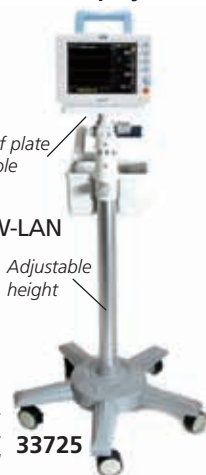

Angle of plate adjustable

Adjustable height

Moving cart increases flexibility around the ward

33725



## • 33725 CART

Adjustable height, basket included. Temperature sensors, cuffs, batteries and accessories see page 351. CO<sub>2</sub> sensors page 350.

### STANDARD ACCESSORIES

- |   |                              |
|---|------------------------------|
| 3 lead patient cable (ECG)                  | Reusable adult cuff 25-35 cm |
| Disposable electrodes: 10 pcs               | Reusable child cuff          |
| SpO <sub>2</sub> sensor - reusable          | DC adaptor (18 VDC, 2.5A)    |
| SpO <sub>2</sub> sensor extension cable 2 m | Battery                      |
| NIBP tubing - 3m                            | User manual: GB, IT          |
| Thermal printer 58 mm                       |                              |

### PATIENT CENTRAL SYSTEM (up to 31 monitors)

It allows the user to monitor and extract the exact status of several patients simultaneously at a place. Convenient bidirectional communication allows you to admit new patient information, set alarms at either central station or patient monitor.

- 33745 WIRE CENTRAL SYSTEM (PC, monitor, 16 port switch and software)
  - 33746 LAN CABLE - 3 m
  - 33767 LAN CABLE - 30 m
- One for any monitor to be connected. Customized cable length on request.
- 33758 WIRELESS CENTRAL SYSTEM (PC, monitor, wireless router and software)
  - 33759 WIRELESS CONNECTION KIT (Ethernet converter and power cable. One for any monitor to be connected.



33745

### TECHNICAL SPECIFICATIONS

<b>GENERAL</b>			
Display:	8" wide colour touch TFT LCD 800x600 pixels	Heart rate accuracy:	± 1bpm or ± 1%, whichever is greater
Dimensions - Weight:	238x250xh 163 mm - 3.1 kg	Sweep speed:	6.25, 12.5, 25, 50 mm/sec
Trace	4 waveforms: 2*ECG, SpO <sub>2</sub> , Respiration	Filter:	Diagnosis: 0.05 to 150 Hz    Moderate: 0.5 to 25 Hz
Indicators	Sweep speed: 6.25, 12.5, 25, 50 mm/sec	Pacemaker detection mode:	Monitoring: 0.5 to 40 Hz    Maximum: 5 to 25 Hz
	Categorized alarms (3 priority levels)	Protection:	Indicator on waveform display (user selectable)
	Visual alarm, QRS beep & SpO <sub>2</sub> Pulse beep	SpO <sub>2</sub> :	Against electrosurgical interference and defibrillation
	Percent (%) SpO <sub>2</sub> pitch tone,	% Saturation Range:	0% to 100% ± 2 digits (70% to 100%)
Thermal printer:	Battery status, External power LED	Pulse rate range:	30 to 254 bpm ± 2 bpm
Battery:	Rechargeable Li-ion battery	NIBP	
	Operating time: 2 hours of continuous operation (when fully charged)	Technique:	Oscillometric
Interfaces:	LAN digital output for transferring data	Measurement Modes:	Manual/automatic/continuous
	DC input connector: 18 VDC, 2.8 A max	Pressure range:	0 to 300 mmHg ±3 mmHg
	External HDMI output for large screen	Measurement range:	Adult pressure: 20 to 260 mmHg
	USB barcode reader		Pediatric pressure: 20 to 160 mmHg
	USB memory data storage / SW upgrade		Neonatal pressure: 20 to 130 mmHg
Operating voltage:	100-240 V, 50-60 Hz	<b>Respirations</b>	
Data storage:	168 hours trends, 20 cases of 10 sec alarm waveform	Method:	Thoracic impedance
ECG		Range:	5 to 120 breath/min
Lead type:	3-lead, 5-lead (option)	Accuracy:	± 1 breath/min
Lead selection:	3-lead I, II, III	Apnea alarm:	yes
	5-lead I, II, III, aVR, aVL, aVF, V (option)	<b>Temperature Unit - optional</b>	
Heart rate range:	Adult: 30 to 300 bpm,	Range:	0° to 50°C (32°F to 122°F)
	Neonate/Pediatric: 30 to 350 bpm	Accuracy:	± 0.1°C (25°C to 50°C), ± 0.2°C (0°C to 24°C)
		Compatible with:	YSI Series 400 Temperature Probes

# BM5 PRO MULTIPARAMETER MONITOR WITH TOUCH SCREEN

• **33776 GIMA BM5 PRO MONITOR - 10.4" TOUCH SCREEN COLOUR TFT LCD - 7 ch ECG**

Arrhythmia analysis: VTAG, VFIB, ASYSTOLIC Pacemaker detection indicated on the ECG waveform display

- Enhanced & expandable multi-parameter patient monitor
- 10.4" touch screen colour TFT LCD with 6 waveforms
- individual sweep speed setting for each parameter
- 168 full hours trend data are stored
- SpO<sub>2</sub> measurement with very low perfusion detection
- screen freeze on/off
- oxyCRG, drug calculation
- external HDMI output for large screens
- connection to central station using LAN or W-LAN - optional
- Li-ion battery with longer time life (3 hours of continuous operation)
- real time bed to bed connectivity, max 8 monitors without server or central station
- EMR direct HL7 with editable menu

- enhanced & expandable multi-parameters:
  - Mainstream/Sidestream EtCO<sub>2</sub> - optional
  - high-performance suntech NIBP (BM5ICU)
- high-performance ECG detection and analysis:
  - enhanced input impedance for dry skin or electrode patch
  - ST level, PVC count, real-time display
  - 13 kinds of arrhythmia analysis
  - pacemaker detection function
- enhanced data management:
  - graphical and tabular trends
  - USB memory storage
- 20 cases - 1 sec. alarm waveform are stored, reviewed and printed

- **33771 TEMPERATURE SENSOR 3 m - skin type - optional**
  - **33772 TEMPERATURE SENSOR 3 m - rectal - optional**
  - **33741 EXACON TEMPERATURE SENSOR 2.75 m - rectal - optional**
- Other accessories page 351.

Selectable software language  
(GB, DE, FR, IT, PT, PL, RO, HU, ES, CZ, BG, RU, TR, CN)



ECG+SPO<sub>2</sub>+NIBP+RESP,  
optional 2 IBP, 2 TEMP, ETCO<sub>2</sub> MODULE

33776



### STANDARD ACCESSORIES

- 3 lead patient cable (ECG)
- Disposable electrodes: 10 pcs
- NIBP tubing - 3m
- Reusable child and adult cuff
- Battery

- SpO<sub>2</sub> sensor - reusable
- SpO<sub>2</sub> sensor extension cable 2 m
- Thermal printer 58 mm
- DC adaptor (18 VDC, 2.5A)
- User manual: GB, IT

### TECHNICAL SPECIFICATIONS

<b>GENERAL</b>	<b>TECHNICAL SPECIFICATIONS</b>	<b>Respirations</b>
Dimensions/Weight: 238x163xh 250 mm/4 kg	Sweep speed: 6.25, 12.5, 25, 50 mm/sec.	Range: 5 to 120 breaths/min ± 1 b/min
Trace: 6 waveform (ECGx2, SpO <sub>2</sub> , RR or EtCO <sub>2</sub> IBPx2)	Filter: Diagnoses: 0.05 to 150 Hz	Apnea alarm: yes
Indicators: categorized alarms (3 priority levels), visual alarm lamp handle, QRS beep, SpO <sub>2</sub> pulse beep, heart rate, SpO <sub>2</sub> pulse pitch tone battery status, external power LED	S-T Segment detection range: - 2.0 to 2.0 mV	<b>Temperature Unit</b>
Thermal printer: 25, 50 mm/sec (paper width 58 mm)	Arrhythmia analysis: Asystole, Vtach, Vfib, Bigeminy, Accvent Couplet, Irregular, Pause, Pvc, Ront, Trigeminy, Vbrady, Shortrun	Range: 0° to 50°C (32°F to 122°F)
Battery: Rechargeable Li-ion (3 hours operating time)	Pacemaker detection mode: Indicator on waveform display (user selectable)	Accuracy: ± 0.1°C (25 to 50°C), ± 0.2°C (0 to 24°C)
Interfaces: LAN digital output for transferring data Nurse call system connection defibrillator sync. output	Protection: against electrosurgical interference and defibrillation	Compatible with: YSI Series 400 Temperature Probes
DC input connector: 18 VDC, 2.8A max	<b>NIBP</b>	<b>IBP - option</b>
Operating voltage: 100-240 V, 50-60 Hz	Technique: Oscillometric with linear deflation	Channels: 2
SpO <sub>2</sub>	Pressure range: 0 to 300 mmHg ± 3 mmHg	Measuring range: -50 to 300 mmHg
% Saturation Range: 0% to 100% ± 2 digits (70 to 100%)	Measurement Modes: Manual-Automatic-Continuous	Measuring accuracy: ± 1 mmHg (<100 mmHg)
Pulse Rate Range: 30 to 254 bpm ± 2 bpm	Safety pressure: Adult: 300 mmHg Neonate: 150 mmHg	± 1% of reading (>100 mmHg)
<b>ECG</b>	Measurement range: Adult pressure: 20 to 260 mmHg Pediatric pressure: 20 to 160 mmHg Neonate pressure: 20 to 130 mmHg	Pulse rate counting range: 0 to 300 beats/min
Lead type: 3-lead, 5-lead	Accuracy: meets accuracy requirements of ANSI/AAMI ISO 81060-2-2013	Zero balancing: range ± 200 mmHg accuracy ± 1 mmHg drift ± 1 mmHg over 24 hours
Lead selection: 3-lead: I, II, III		Transducer sensitivity: 5µV/V mmHg
ECG Waveforms: 3-lead 1 channel 5-lead: 1/2/7 channels		<b>EtCO<sub>2</sub> - Respironics option</b>
Heart rate range: Adult: 30-300 bpm Neonate/pediatric: 30-350 bpm		Measurement mode: Sidestream or Mainstream
Heart rate accuracy: ± 1 bpm or ± 1%, whichever is greater		Measurement range: 0-150 mmHg, 0 to 19%
		Respiration range: 2-150 bpm
		Accuracy: ± 2 mmHg, 0-40 mmHg ± 5%, 41-70 mmHg ± 8%, 71-100 mmHg ± 10%, 101-150 mmHg
		Respiration accuracy: ± 1 breath per minute

## RESPIRONICS CO<sub>2</sub> SENSORS: CAPNOSTAT MAINSTREAM AND LOFLO SIDESTREAM

• **33796 LOFLO SIDESTREAM CO<sub>2</sub> SENSOR** for intubated and non intubated patients

Flexible and compact CO<sub>2</sub> sensor that provides consistent and reliable CO<sub>2</sub> monitoring of adult, pediatric and neonatal patients. No calibration required. 50 ml/minute sampling rate.



33796

• **33797 CAPNOSTAT MAINSTREAM CO<sub>2</sub> SENSOR** for intubated patients

Small, durable and lightweight mainstream CO<sub>2</sub> sensor provides accurate and reliable monitoring for all intubated patients from neonates to adults. No calibration required. Fast airway measurement.

Capnostat® Mainstream CO<sub>2</sub> sensor



33797

**33790**  
Airway adapter set with dehumidification tubing for intubated adult. Suitable also for VET (dog, horse)

**33791**  
Airway adapter set with dehumidification tubing for intubated infants. Suitable also for VET (cat, puppy)



GIMA code	EtCO <sub>2</sub> ACCESSORIES for 33796 - box of 10
33790	Intubated Filter Line H - adult
33791	Intubated Filter Line H - infant
33792	Non intubated CO <sub>2</sub> nasal cannula - adult
33793	Non intubated CO <sub>2</sub> nasal cannula - pediatric
33794	Non intubated CO <sub>2</sub> +O <sub>2</sub> nasal cannula - adult
33795	Non intubated CO <sub>2</sub> +O <sub>2</sub> nasal cannula - pediatric

### COMPATIBILITY OF LOFLO AND CAPNOSTAT CO<sub>2</sub> SENSORS

Brand	Model
Bionet	BM1, BM3 Pro, BM5, BM5 Pro
Contec	CMS 8000
Creative	PC-3000, UP7000, K10, K12, K15
Mindray	Various
Philips	Various

## ECG CABLES FOR BM GIMA AND BIONET MONITORS

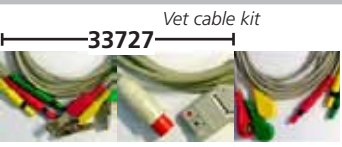
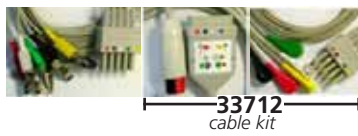
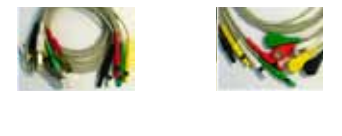
GIMA code	ECG CABLES FOR BM3 (33718, 33719, 33720, 33780, 33781)	ACCESSORIES FOR MONITOR BM3, BM5, BM7	
		NEW (after 6/2006)	OLD (before 6/2006)
33711	3-lead patient cable kit (cable+snap connectors 33748)	 <p>33713 Vet cable kit</p> <p>33760 Vet clip connect</p> <p>33762 Cable</p> <p>33748 Snap connect</p>	 <p>33727 Vet cable kit</p> <p>33752 Vet clip connect</p> <p>33726 cable kit</p> <p>33750 Snap connect.</p>
33712	5-lead patient cable kit (cable+snap connectors 33749)		
33726	3-lead patient cable kit (cable+snap connectors 33750)		
33727	3-lead veterinary cable kit (cable+3 clips connectors)		
33713	3-lead veterinary cable kit (cable+3 clips connectors)		
33748	3-lead snap connectors for 33711 - spare - new	 <p>33712 cable kit</p> <p>33761 Vet clip connect</p> <p>33763 Cable</p> <p>33749 Snap connect</p>	 <p>33753 Vet clip connect</p> <p>33751 Snap connector</p>
33749	5-lead snap connectors for 33712 - spare - new		
33750	3-lead snap type connectors for 33726 - spare - old		
33751	5-lead snap type connectors for 33728 - spare - old		
33752	Vet 3-lead clip type connectors for 33726-7 - spare - old		
33753	Vet 5-lead clip type connectors for 33728 - spare - old		
33760	Vet 3-lead clip type connectors for 33713 - spare - new		
33761	Vet 5-lead clip type connectors for 33712 - spare - new		
33762	3-lead patient cable		
33763	5-lead patient cable		
<b>ECG CABLES FOR BM5-BM7 (33776, 33777, 33778, 33779)</b>			
33764	3-lead patient cable kit (cable + snap connector)		
33765	10-lead patient cable kit (cable + snap connector) only 33778		
33766	3-lead veterinary cable kit (cable + clip connector)		











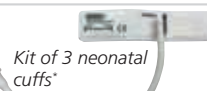

## BM1, BM3, BM5, BM7 SpO<sub>2</sub> SENSORS

GIMA code	SpO <sub>2</sub> SENSORS AND EXTENSION CABLE FOR ALL BM MONITORS	SpO <sub>2</sub> REUSABLE PROBES		SpO <sub>2</sub> EXTENSION CABLE
		33730	Adult reusable finger sensor* (> 45 kg) - 7 pin	 <p>7 pin</p> <p>33730</p> <p>33731</p>
33731	Pediatric reusable finger sensor* (15-45 kg) -			
33732	Vet reusable sensor* - clip <i>*Needs extension cable 33716</i>			
33716	Extension cable**, 2 m (7 pin big SpO <sub>2</sub> connector) since 2007 <i>**Necessary for all probes</i>			

## NELLCOR COMPATIBLE DISPOSABLE SpO<sub>2</sub> SENSORS

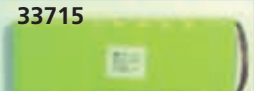
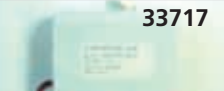
 <p>33757</p> <p>33754</p> <p>33755</p> <p>33756</p>	<p>All sensors are supplied in sterile pack with 70 cm cable.</p>										
<table border="1"> <thead> <tr> <th>GIMA code</th> <th>NELLCOR COMPATIBLE DISPOSABLE SpO<sub>2</sub> SENSORS (not compatible with Nellcor Oximax)</th> </tr> </thead> <tbody> <tr> <td>33755</td> <td>Disposable neonate/adult sensor - under 3 kg (neonate foot) - over 40 kg (adult finger)</td> </tr> <tr> <td>33756</td> <td>Disposable infant sensor - 3-20 kg</td> </tr> <tr> <td>33757</td> <td>Disposable pediatric sensor - 10-50 kg</td> </tr> <tr> <td>33754</td> <td>Disposable adult sensor - over 30 kg</td> </tr> </tbody> </table>	GIMA code	NELLCOR COMPATIBLE DISPOSABLE SpO <sub>2</sub> SENSORS (not compatible with Nellcor Oximax)	33755	Disposable neonate/adult sensor - under 3 kg (neonate foot) - over 40 kg (adult finger)	33756	Disposable infant sensor - 3-20 kg	33757	Disposable pediatric sensor - 10-50 kg	33754	Disposable adult sensor - over 30 kg	<p><b>TECHNICAL SPECIFICATION SpO<sub>2</sub> SENSORS</b></p> <p>Range of SpO<sub>2</sub> measurement: 70%~100%</p> <p>Accuracy: 70%~100% ±2%; below 70%: unspecified</p> <p>Range of pulse measurement: 30~250 bpm</p> <p>Accuracy: ±2 bpm of 2% (select larger)</p> <p>Optical Sensor: red light (wavelength is 650~670 nm, 6.65 mW) infrared (wavelength is 880~910 nm, 6.75 mW)</p>
GIMA code	NELLCOR COMPATIBLE DISPOSABLE SpO <sub>2</sub> SENSORS (not compatible with Nellcor Oximax)										
33755	Disposable neonate/adult sensor - under 3 kg (neonate foot) - over 40 kg (adult finger)										
33756	Disposable infant sensor - 3-20 kg										
33757	Disposable pediatric sensor - 10-50 kg										
33754	Disposable adult sensor - over 30 kg										

## BM1, BM3, BM5, BM7 MONITOR ACCESSORIES

GIMA code	ACCESSORIES FOR BM1, BM3, BM5, BM7	
33738	<b>NIBP</b> Extension cable, 3 m (necessary for all cuffs) Adult cuff 27.5-36.5 cm need ext. cable 33738 Child cuff - need ext. cable 33738 Obese cuff - need ext. cable 33738 Kit of 3 neonatal cuffs* - needs cable 33738 Mini cuff size 16x5 cm - needs 33738+33739 Mini cuff size 23x5 cm - needs 33738+33739 Metal connector (necessary for mini cuff)	 <p>Kit of 3 neonatal cuffs*</p> <p>33737</p>
33735		 <p>33735</p>
33736		 <p>33736</p>
32848		 <p>32810</p>
33737		 <p>32811</p>
32810		 <p>33738</p>
32811	 <p>33771</p>	
33739	 <p>33772</p>	
33771	 <p>33742</p>	
33772	 <p>33715</p>	
33743	 <p>33717</p>	
33742		
33715		
33707		
33717		
33710		
33709		
33747		

\*Cuff range 3.3-5.6 cm, 4.2-7.1 cm, 5-10.5 cm

\*\*Date is approximative. Please select battery according to picture and specifications

\*\*\*Compatible with Dräger MM15114, MM15822, GE 21733601, Philips HP21059B, Nihon Kohden P242A, Datascope 0206-02-0003

# REUSABLE COMPATIBLE SPO<sub>2</sub> SENSORS FOR ALL BRANDS



1- Adult finger sensor		2- Adult soft-finger sensor		3- Adult Y-type ear sensor		4- Adult-neonatal wrap sensor		5- Pediatric sensor		6- Neonatal Y-type sensor	
GIMA code	OEM - Brand	N	Sensor type	Cable length	Connector type	Compatibility				Extension cable - 2.4 m	
35220*	BCI	5	Pediatric finger	0.9 m		BCI: 3401, 3304, 3303, 3302, 3301, 3300; Spacelabs Burdick: PRO <sub>2</sub> ; Draeger: Oxipac 2000/2500	-	-	-	35300	
35221		1	Adult finger	0.9 m							
35222		1	Adult finger	3.0 m							
35225	CSI (Criticare)	6	Neonatal Y-type	3.0 m		Alaris (IVAC): VitalCheck 4400; Criticare: 503DX, 503 Spot, 504DX/P, 504DX, 506 series (except 506LN3), 507ELC2, 8100 Poet Plus, Poet (602-3A), Scholar, Scholar III	-	-	-	-	
35226		1	Adult finger	0.9 m							
35227		1	Adult finger	3.0 m							
35230*	Datascope	1	Adult finger	0.9 m		Accusat, Accutorr 3/4 SAT, Accutorr Plus, Passport (Database SpO <sub>2</sub> )	-	-	-	35301	
35231		1	Adult finger	3.0 m							
35232*	Datex-Ohmeda	1	Adult finger	0.9 m		Datex-Ohmeda: AS/3 ,CS/3, CH/5, CH/2S, CH-RS, SAF-F, CG/2S, Cardiocap I, Cardiocap II, Cardiocap 5, Capnomac Ultima, Light Monitor, M-Estpr, Oscar II, OSP-200, Satlite Trans, Satlite, Trans Plus, System 5, ULT500	-	-	-	35302	
35233		5	Pediatric finger	3.0 m							
35234		1	Adult finger	3.0 m							
35235		3	Adult Y-type ear sensor	3.0 m							
35238	GE Datex-Ohmeda	1	Adult finger	3.0 m		GE (Datex-Ohmeda): S/5, i4 Modular Monitors with Eseries modules, Corometrics® 259 with TruSignal Ohmeda Technology	-	-	-	-	
35239		1	Adult finger	4.0 m							
35240		2	Adult soft-finger	3.0 m							
35241		3	Adult Y-type ear	3.0 m							
35243		1	Adult finger	3.0 m		Ohmeda TruSat Ohmeda TruSat TD	-	-	-	-	
35245	GE	1	Adult finger	3.0 m		GE: Dash 2000/3000/4000 with Nellcor option, Dash 3000/4000/5000 with Ohmeda option, Solar 8000/8000M, i/9500 with Tram Module 451/451N/ 851/851N, CardiLab®/Mac-Lab® with Tram Module 451/451N, Corometrics® 120/2120 series, Eagle 1000/3000/4000 Responder 3000 with Nellcor option	-	-	-	-	
35247*	GE TruSignal	1	Adult finger	0.9 m		TruSignal sensors and interconnect cables are backwards compatible with Datex, ohmeda and GE SpO <sub>2</sub> technologies.	-	-	-	35303	
35250	Goldway	1	Adult finger	3.0 m		Goldway: UT4000 A / 4000 A pro / 4000B, UT6000 C	-	-	-	-	
35252	Mindray	1	Adult finger	3.0 m		PM-600, PM-5000, PM-6000, PM-7000, PM-8000, PM-9000, MEC-1000 (Nellcor based) PM-50	-	-	-	-	
35255**	Nellcor	6	Neonatal Y-type	0.9 m		Artema: Diascope, Datascope: (Mindray): Accutorr Plus, Expert, Passport, PM-50; Drager: Cicero, Narkomed, Vitalert 1000, GE Medical: Corometrics 118, 120, 129, 188, 510, 556, Critikon 9710, 9720, Plus, Compact, Dinamap Select, MPS, Oxyshtuttle, Pro 300/400, Eagle Series, Dash Series, Hellige Eagle, 1000, 3000, Eagle SMK, SMU, SMV, SOLAR Series, TRAM Modular x50SL Series; Invivo Research: M12 (Nellcor SpO <sub>2</sub> ), Millennia 4500 Plus 2, Invivo/MDE Escort 100 OPT11A Escort 300A, Escort II OPT30, Prism (Nellcor SpO <sub>2</sub> ); Ivy Biomedical: 405A, 4050, 405P, 405T, Vital-Guard 450 CN, Mennen: Horizon XL (Nellcor SpO <sub>2</sub> ), MR 1300 Mercury 1200; Nellcor: N100 (req. preamp cable), N180, N200 (req. preamp cable), N-20, NPB-75, NPB-290, NPB-295, N-390, N-395, N-3000, N6000; Nihon Kohden: BSM-1102 Life Scope EC, BSM2304 iPro (Life Scope i), BSM-4102, 4112 Procyon LT (Life Scope P), BSM-4104, 4114 Procyon (Life Scope P), BSM-9510 Life Scope M (Nellcor SpO <sub>2</sub> ), OGS2000 PocketCare (Nellcor SpO <sub>2</sub> ); Pace Tech Vitalmax 800 Series (cara negra Nellcor SpO <sub>2</sub> ); Philips 78352C, 78354C, 78834C, M1020A, M1025B, M1205A, M1350B, M1 722A/B, M1732A/B, M2475B, M2601A, M3000A	-	-	-	35304	
35256**		5	Pediatric finger	0.9 m							
35257**		4	Adult/neonatal wrap	0.9 m							
35258**		1	Adult finger	0.9 m							
35259**		1	Adult finger	3.0 m							
35260**		2	Adult soft-finger	0.9 m							
35261**	3	Adult Y-type ear	3.0 m								
35262**	Nellcor Oxitech	1	Adult finger	0.9 m		Nellcor Oximax: N-550, N-560, N-595, N-600 and Patient monitors with Oximax module	-	-	-	35305	
35263**		2	Adult soft finger	0.9 m							
35265**		4	Adult/neonatal wrap	0.9 m							
35264	Nihon-Kohden	1	Adult finger	3.0 m		Nihon Kohden: BSM-4101, 4103 4111, 4113 Life scope P BSM-5105, 5135 Life scope A BSM-2351, 2353 Life scope L BSM-2301, 2303 Life scope I, Life scope S	-	-	-	-	
35266**	Nonin	1	Adult finger	0.9 m		NONIN: 8500, 8600, 8700, 8800/9840 NONIN: 2500, 9600, 9700	-	-	-	-	
35268	Novamatrix	6	Neonatal Y-type	3.0 m		Novamatrix: 505, 510, 511, 515B/C, 520, 7000, 7100; Oxypleth	-	-	-	-	
35269		1	Adult finger	3.0 m							
35272	Ohmeda	1	Adult finger	3.0 m		Datex-Ohmeda: 3740, 3710, 4700 OxiCap, 520RGM, Biox 3760, Ohmeda 3700, 3770, 3775, Rascal II, GE Medical System: 7000 series, Corometrics 511, TRAM A.R., Tram Modular x00SL Series, Mennen: Horizon XL800 (Ohmeda SpO <sub>2</sub> )	-	-	-	-	
35275	Philips	6	Neonatal Y-type	1.6 m		Philips: M3, M4, MP20, MP30, MP40, MP50, MP70, MP80, VM4, VM6, VM8	-	-	-	-	
35276		4	Adult/neonatal wrap	1.6 m							
35277		1	Adult finger	1.6 m							
35278		1	Adult finger	3.0 m							
35279		2	Adult soft-finger	1.6 m							
35280		2	Adult soft-finger	3.0 m							
35281	3	Adult Y-type ear	3.0 m								
35283		2	Adult soft-finger	3.0 m		Philips: 1205, M1205A, 78352C, 78834C, 78354C, M1020A, M1025A, M1025B, M1350B, M1772A/B, M1732A/B, M2475B	-	-	-	-	
35285	Siemens/ Drager	1	Adult finger	1.6 m		Siemens/Drager: SC6002XL, 7000, SC8000, SC9000XL	-	-	-	-	
35286		2	Adult soft-finger	1.6 m							
35287		3	Adult Y-type ear	1.6 m							

\*These SpO<sub>2</sub> sensors need extension cable for connection to device.

\*\* Available extension cable.

All products are supplied with manual in GB, FR, IT, ES.

# COMPATIBLE PADS FOR OVER 90% OF DEFIBRILLATORS ON THE MARKET

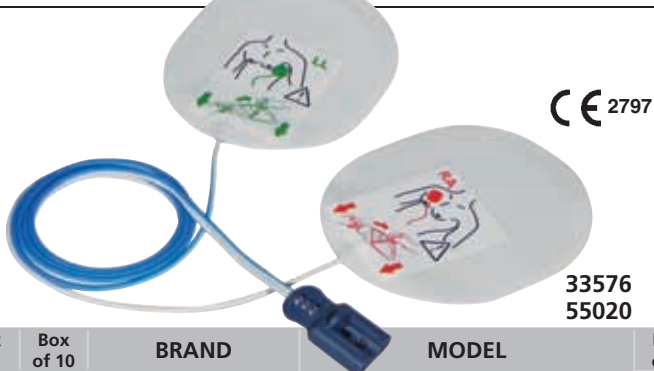

## ADULT COMPATIBLE PADS - disposable

A range of compatible pads BSI certified for patients >8 years (25 kg) for most defibrillators on the market. Excellent adherence and adequate gel thickness. Includes a couple of pads, cable and connector. Maximum shelf life 30 months (24 months for 33584) from production date. Latex free. Compliance to regulations: Directive 93/42/EEC and amendments. Class IIb medical device. ANSI/AAMI: DF-80; IEC/EN: 60601-1, 60601-2-4; ISO: 10993-1. Multilingual envelope: GB, FR, IT, ES, PT, DE, NL, SE, GR, RU. **MADE IN ITALY**

Box of 1	Box of 10	BRAND	MODEL	Box of 1	Box of 10	BRAND	MODEL
33576	55020	Agilent-Philips	- Heartstream/HeartStart XL M4735A - Heartstream/HeartStart XLT M3500B - HeartStart XL 861290 - HeartStart 4000 M5500B (all with Philips cable M3508A)	33579	55036	Nihon Kohden	Cardiolife TEC 2202 - 2203 - 5500 - 7531 - 7600 - 7700 - 8251 all with cable JC-755V, TEC 5600 - 8300 with cable JC855V
33577	55022	Agilent Hewlett-Packard	- Codemaster 100-XE-XL-XL+ - Heartstream XL, XLT, XL+ with cable M3507A	33576	55020	Philips Laerdal Medical	- Heartstream Fore Runner I AED models E, S, EM - Heartstart FR1 AED 940010XX - 940020XX - 940030XX - Heartstart FR2 AED M3841A - M3861A - Heartstart FR2+ AED, with ECG module M3840A, M3860A - Codemaster M1722A/B, M1723A/B, M1724A, M2475B (with Philips cable M3507A and pad adapter 05-200) - Heartstart MRx M3535A (with Philips cable M3508A)
33579	55036	Artema Innomed	- Cardio Aid 100 - 200 - 200B - 360B - XL - XL+	33587	55048	Physiocontrol	- Lifepak 9 connector Quick-Combo - Lifepak 10 - 12 - 15 - 20 - 20E - 500 AED pink or grey socket - 1000 AED - Fred Easy - Fred Easy 2G - Defigard DG4000 - DG5000 - DG6002 - Defigard DG1002 - DG3002 - DG2000 EDOS - Fred - Fred Tele - Fred easy port - Argus PRO Lifecare - Argus PRO Lifecare 2 - Fred PA-1 - Cardiovit AT 101 Easy - Defigard Touch 7
33579	55036	Artema S&W	- Cardio Aid LS - MC - MC+	33588	55052	Schiller	- Cardio Aid LS - MC - MC+ - Tecnoheart Plus (for patient >10 kg)
33587	55048	Bexen Cardio	- Reanibex 200 - 300 - 500 - 700 - 800	33586	55038	Schiller	- Meducare easy - Meducare standard - AED 10 - AED20 - PIC30 - PIC40 - PIC50
33580	55026	Cardiac Science	- Powerheart AED 9200 series - Powerheart AED G3 9300 series (G3, G3 Plus, G3 Pro)	33592	55054	Schiller	- Zoll PD 1200 - 1400 - 1600 - 1700 - 2000 - E - M - R - X series - Pro paq MD - Aed Plus - AED Pro - AED 3 without CPR function
33581	55028	Cardiaid	- Cardiaid CT0207	33579	55036	S&W	- Cardio Aid LS - MC - MC+
33587	55048	Cardioline	- Elife 700	33584	55046	Tecno-Gaz	- Tecnoheart Plus (for patient >10 kg)
33448	55030	Cmos Drake	- Futura	33581	55028	Weinmann	- Meducare easy - Meducare standard
33448	55030	CU Medical System	- i-PAD NF1200	33579	55036	Welch-Allyn	- AED 10 - AED20 - PIC30 - PIC40 - PIC50
33578	55034	Defibtech	- DDU 100 Lifeline AED - DDU 120 Lifeline Auto AED	33589	55058	Zoll Medical Corp	- Zoll PD 1200 - 1400 - 1600 - 1700 - 2000 - E - M - R - X series - Pro paq MD - Aed Plus - AED Pro - AED 3 without CPR function
33579	55036	Drager	- Cardiolog 2000	33585	55060	Zoll Medical Corp	- Zoll PD 1200 - 1400 - 1600 - 1700 - 2000 - E - M - R - X series - Pro paq MD - Aed Plus - AED Pro - AED 3 without CPR function
33586	55038	Esaote	- MDF SAED - MDF II				
33580	55026	GE	- Responder AED - AED Pro				
33583	55042	GE	- Responder 1100 - 2000 - 3000 (direct connection) - Cardioserv (direct connection) - Dash Responder (direct connection)				
33579	55036	Innomed	- CardioAid 200B - 200 - 100 - 360B - XL+ - XL				
33577	55022	Laerdal	- HeartStart 4000				
33589	55058	M&B	- AED 7000				
33582	55044	Mediana	- HeartOn AED A10				
33584	55046	Mediana	- HeartOn AED A15 (patient >10 kg)				
33609	55050	Metrax Primedic	- Heartsave AED - AED-M - 6 - 6S since S.N. 739xxxxxx - Defimonitor XD				
33587	55048	Mindray	- Beneheart D1 - D3 - D6				
33579	55036	MRL	Lite - Liferequest				

## COMPATIBLE PADS' CONNECTORS TO DEFIBRILLATOR



# PEDIATRIC COMPATIBLE PADS WITH ENERGY REDUCTION SYSTEM

## PEDIATRIC\* COMPATIBLE PADS - disposable

These pads have an energy reduction system: defibrillator output of 150J (33606) or 200J (33603) is reduced to 50J. International compliance to regulation as above adult compatible pads. Latex free. **MADE IN ITALY**

\*CPR guidelines state 8 years as limit age for pediatric treatment, corresponding to about 25 kg according to standard growth curves.

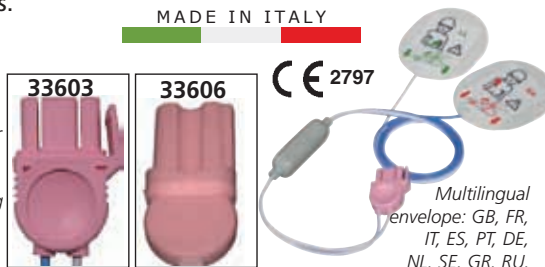

Box of 1	Box of 5	Box of 10	BRAND	MODEL
33604	55002	-	Cardiac Science	- Powerheart AED 9200 series - Powerheart G3 AED 9300 series (G3, G3 Plus, G3 Pro)
33604	55002	-	GE	- Responder AED, AED Pro
33584	-	55046	Mediana	- HeartOn AED A15 (patient >10 kg)
33606	55006	-	Philips Laerdal Medical	- Heartstart FR2 AED M3841A & M3861A - Heartstart FR2 AED, with ECG module 3840A, M3861A, 3860A
33603	55004	-	Physiocontrol	- Lifepak 500 AED pink socket - Lifepak 1000 AED - Lifepak CR plus AED - Lifepak Express AED
33584	-	55046	Tecno-Gaz	- Tecnoheart Plus (patient >10 kg)

## ORIGINAL CU, PRIMEDIC AND PROGETTI PADS

GIMA code	PEDIATRIC PADS: BRAND - MODEL	GIMA code	ADULT PADS: BRAND - MODEL
33569 33443 35345	<b>CU Medical System</b> CU-ER1, CU-ER2, CU-ER3 iPad NF 1200 CU-SP1, CU-SP2	35345	<b>CU Medical System</b> CU-ER1, CU-ER2, CU-ER3 iPad NF 1200 CU-SP1, CU-SP2
35390 33458	<b>Metrax-Primedic</b> HeartSave Pad, AED, AED-M, 6, 6S since S.N. 739xxxxxxx <b>Progetti</b> Rescue Sam, Rescue 230, Rescue Life 5.7" and 7" with cable	33458	<b>Metrax-Primedic</b> HeartSave Pad, AED, AED-M, 6, 6S since S.N. 739xxxxxxx <b>Progetti</b> HeartSave Pad, AED, AED-M, 6, 6S up to S.N. 738xxxxxxx Defimonitor XD1, XD3, XD10, XD30, XD100, XD300, XD110, XD330
			<b>Progetti</b> Rescue 230, Rescue Life 5.7 "and 7" Rescue Sam with cable
			33461 33420

## COMPATIBLE DEFIBRILLATOR ECG THERMAL PAPER - DIFFERENT BRANDS

GIMA code	MANUFACTURER AND MODEL	Type	Width mm	Length m	Sheet	Marker	Grid*	Min. order	GIMA code	MANUFACTURER AND MODEL	Type	Width mm	Length m	Sheet	Marker	Grid*	Min. order
33098	<b>Bexen</b> Reanibex - 800	roll	106	20	-	no	or/red	10	32988	<b>Physio control</b> Life Pack 9	roll	50	30	-	no	or/red	20
33100	<b>Corplus</b> Corplus 3	roll	106	20	-	no	or/red	10	33032	Life Pack 8-9-10	roll	50	23	-	no	or/red	20
33103	<b>Hewlett Packard</b> 40457C/D, Codemaster 100, XL	roll	50	30	-	no	or/red	20	33033	Life Pack 11-12-15-20	roll	107	25	-	no	or/red	10
32968	<b>Mindray</b> Defi/Monitor BeneHeart D3, D6	roll	50	20	-	no	or/red	20	32963	<b>Schiller</b> Defigard 3002	roll	50	25	-	no	or/red	20
33029	<b>Nihon Kohden</b> Def. TEC 5521, 5531, BSM 2300, 3000	pack	50	100	200	no	or/red	25	32983	Defigard 6002	pack	80	70	300	yes	or/red	20
32988	<b>Philips</b> Tech-8300	roll	50	30	-	no	or/red	20	32988	<b>Welch Allyn</b> Pic-30	roll	50	30	-	no	or/red	20
33102	Defibrillator MRX	roll	75	25	-	no	or/red	10	33106	<b>Zoll</b> Defi/1400 (P/N 8000-0300)	pack	90	90	200	yes	or/red	20
33103	Heartstart XL	roll	50	30	-	no	or/red	20	32964	X Series	roll	80	25	-	no	white	10
									33647	R Series, X Series	roll	80	25	-	no	or/red	10

\*or/red: grid could be orange or red colour

## KIT FOR DEFIBRILLATOR

### • 34219 DEFIBRILLATOR ACCESSORIES KIT

Pocket mask kit with accessories for reanimation and defibrillation. Kit includes:

- 1 pocket mask,
- 1 antiseptic wipes,
- 4 vinyl gloves,
- 1 disposable razor,
- 3 packs of sterile gauzes.



CE 0197  
34219

## DAE-AED SIGNS

- 35326 DAE-AED ALUMINIUM FRONT SIGN 29x36 cm
- 35327 DAE-AED DOUBLE-SIDED ALUMINIUM SIGN - 34x36 cm

Signs in aluminium foil with thickness 5/10. Pre-painted white with silkscreen in green colour. Pre-drilled for wall mounting.



Signs comply with  
UNI EN ISO 7010:2012

350 g



## METAL CABINETS FOR DEFIBRILLATORS - INDOOR OR OUTDOOR

### METAL CABINETS FOR DEFIBRILLATORS - INDOOR USE

- 35330 METAL CABINET - INDOOR USE - white
  - 35331 METAL CABINET WITH ALARM - INDOOR USE - white
- Door with opening at 180° with transparent acrylic window. Suitable for wall mounting or use with pole. Horn alarm at 100 dB (only 35331)
- 35333 POLE for cabinet - white

### METAL CABINETS FOR DEFIBRILLATORS - OUTDOOR USE\*

\*Not suitable for marine or corrosive environments. Special coated cabinets resistant to mentioned environments available on request in 30 days

- 35334 METAL CABINET - OUTDOOR USE - yellow
  - 35335 METAL CABINET WITH THERMO REGULATION SYSTEM AND ALARM - OUTDOOR USE - yellow
- Water tight welding on the sides, water and dust proof gaskets. Made of carbon steel, thickness 15/10. Adjustable internal shelf. Door with transparent acrylic window.
- Same as 35334, with antitheft magnetic sensor that activates a 100 dB siren in case of non authorized withdrawal. 9V alkaline battery for alarm. Low charger indicator. Power 230V for thermoregulation. Suitable for wall mounting or use with pole.
- 35337 POLE for cabinet - yellow

### INDOOR USE



External size: 42.5x18xh 42.5 cm  
Internal size: 40x15xh 40 cm

### OUTDOOR USE



External size: 43x21xh 48 cm  
Internal size: 42x20xh 45 cm

IP 44  
PROTECTION

# RESCUE SAM AED DEFIBRILLATORS - SEMI OR FULL AUTOMATIC

**5 YEARS WARRANTY**

Rescue Sam with carrying bag 33421

**33425 + 33421**

Semi automatic



Full automatic



Information button

CE 0068

33419

Start button

Shock button



33170

MADE IN ITALY

### TRAINER AED RESCUE SAM PRO

Designed to effectively train emergency responders to the use of RESCUE SAM, thanks to simple, clear, spoken and visual instructions. 5 pre-programmed scenarios selected directly by the remote control. Totally safe real shock simulation. Supplied with remote control, training pads, battery charger.

Semi or full automatic external defibrillators designed for public use by minimally trained people. They provide easy and simple indications for rescue operations. Designed to treat Ventricular Fibrillation (VF) and Fast Ventricular Tachycardia (VT). Supplied with lithium battery, set of adult pads and manual. According to AHA/ERC Guidelines 2015.

### RESCUE SAM DEFIBRILLATOR - Semi automatic

English	Italian	French	Spanish	Other languages*
<b>33425</b>	<b>33426</b>	<b>33427</b>	<b>33430</b>	<b>33559</b>

\*Other languages available in 20 days: DE, PL, RU (manual and voice), PT, CZ, FI, GR, LT, NL, RO, TR, KR, TH (voice with English manual)

### RESCUE SAM DEFIBRILLATOR - Full automatic\*\*

<b>33165</b>	-	<b>33167</b>	-	-
--------------	---	--------------	---	---

\*\*Other languages available in 20 days: IT, ES, (manual and voice), DE, GR, HU (only voice)

### TRAINER FOR SEMI-AUTOMATIC RESCUE SAM

<b>33170</b>	<b>33171</b>	-	-	<b>33174***</b>
--------------	--------------	---	---	-----------------

\*\*\*Other languages available in 20 days: ES, FR, PL (voice only)

### GIMA code ACCESSORIES FOR RESCUE SAM DEFIBRILLATORS

<b>33558</b>	USB PC interface	
<b>33419</b>	Lithium battery pack	
<b>33458</b>	Disposable pediatric pads (kit of 2) with cable	
<b>33420</b>	Disposable adult pads (kit of 2) with cable	
<b>33421</b>	Carrying bag	

### TECHNICAL SPECIFICATIONS

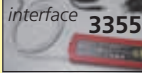
Operating mode:	Semi-automatic or Full-automatic	
Waveform:	BTE (Biphasic Exponential Truncated) impedance compensated	
Energy:	200 J fixed	33558
Charge control:	Automatic by software (Arrhythmia Detection System and charging control)	
Charge time:	< 8 seconds, typical with new battery	
Shock delivery vector:	adult pads in the anterior (Lead II) position or reduced energy paediatric pads in anterior-posterior position	
Voice instructions:	Vocal and optical message guide	
Automatic manual tests:	Battery insertion test and daily self tests	
Long life lithium battery:	12 Volt DC, 4.2 Ah, LiMnO <sub>2</sub> , disposable	
Battery capacity:	200 shocks or 4 hours of continuous operating time	
Data recording, stored:	8 events (60 min. of ECG each) and entire incident	
Size-weight:	30x28x9 cm - 2.3 kg with battery	

# i-PAD NF 1200 PUBLIC ACCESS DEFIBRILLATOR

**5 YEARS WARRANTY in standby mode\***

Semi-automatic external defibrillator designed for minimally trained individuals. It provides simple and direct voice prompts and indications for a straightforward rescue operation. Lightweight and battery powered for maximum portability. Designed to treat Ventricular Fibrillation (VF) and Fast Ventricular Tachycardia: the most common causes of sudden cardiac arrest (SCA). The only effective treatment for VF is the application of a defibrillating shock. It may be used on children 1-8 years old (less than 25 kg) with pediatric reduced energy pads, over with adult pads. Supplied with a set of adult pads, lithium battery (200 Shocks or 10 hours operating time), manual. According to ERC Guidelines 2015.

**TRAINER:** simulates all the functions of i-PAD, with 8 rescue scenarios.

Voice version and manual	i-PAD DEFIBRILLATOR AND TRAINER					
	Spanish	French	Portuguese	Italian	English	Other languages*
<b>DEFIBRILLATOR</b>	<b>33408</b>	<b>33409</b>	<b>33413</b>	<b>33414</b>	<b>33416</b>	<b>33417</b>
<b>TRAINER</b>	-	-	-	<b>33424</b>	<b>33405</b>	<b>33406</b>

\*Voice languages: DE, DK, KR, JP, NL, SE, with same language manual, updated to ERC guidelines 2010; CZ, GR, IL, IR, NO, TR, with English manual, updated to ERC guidelines 2005

### GIMA code ORIGINAL ACCESSORIES FOR i-PAD

<b>33418</b>	Lithium battery pack for i-PAD and i-PAD trainer (for 200 Shocks)
<b>33441</b>	Disposable adult pads - kit of 2 pcs
<b>33443</b>	Disposable pediatric pads - kit of 2 pcs
<b>33422</b>	Carrying bag
<b>33423</b>	Wall cabinet with alarm sound
<b>33403</b>	IrDa connector for data communication + software for event recording download with key file



CE 2460 JFDA



33405, 33406, 33424



Size: 32.5x34x18 cm  
33423



33422

### TECHNICAL SPECIFICATIONS

Operating mode:	Semi-automatic	Charge time from "Shock advised":	< 10 seconds, typical
Waveform:	e-cube biphasic (Truncated exponential type); impedance compensated	Voice instruction:	Voice messages guide through use of defibrillator
Energy:	200J fixed	Controls:	Shock Button, i-Button, On/Off Button
Shock energy accuracy:	Adult: nominal 200J into a 50 ohm load	Indicators:	7 LEDs (different colours), i-Button
Shock to shock cycle time:	Infant/child: nominal 50 joules into a 50 ohm load	Patient isolation:	Type BF, defibrillation protected
Protocol:	Within ±3% (200J into 50 Ω)	Battery:	12 Volt DC, 4.2 Ah, lithium manganese dioxide, disposable long-life primary cell
Charge control:	Automatic by Software (Arrhythmia Detection System and Charging Control)	Battery capacity:	Min. 200 Shocks or 4 hours of operating time
		Data recording:	Data Stored: First 40 minutes of ECG and the entire incident's events and analysis decision
		Size - Weight:	220x260x70 mm - 2.2 kg (4.84 lbs) with battery pack



# i-PAD CU-SPR PUBLIC ACCESS DEFIBRILLATORS

## SEMI AUTOMATIC i-PAD CU-SPR DEFIBRILLATORS

Advanced and intuitive public access Semi-automated External Defibrillator (AED). CU-SPR is simple to use, light, portable and supports both adult and pediatric patients rescue operations. It automatically reads patient's electrocardiogram (ECG) and determines if a cardiac arrest has occurred and a defibrillation is required.

The defibrillator has integrated voice prompts, LED and graphical indicators that can guide people throughout the rescue operation.

Battery and pads status can be quickly monitored on the LCD screen so that the device is always ready to use.

Thanks to its highly water and dust resistant case, CU-SPR can be used even in wet and rough conditions.

Suitable for public use.

### Key features:

- device and consumables status on LCD screen for quick monitoring
- CPR metronome, voice guidance and graphic instructions
- adult-pediatric mode with quick change button
- data transfer via USB, need optional key

### Technology

- semi automated e-cube biphasic defibrillation
- combined adult/pediatric pads for dedicated pediatric pads support
- automatic background noise analysis and device volume adjustment
- CPR step detection indicator for more effective CPR

### Safety

- highly water resistant case IP66
- automatic internal discharge
- daily, weekly and monthly self-test
- shock resistant carrying case

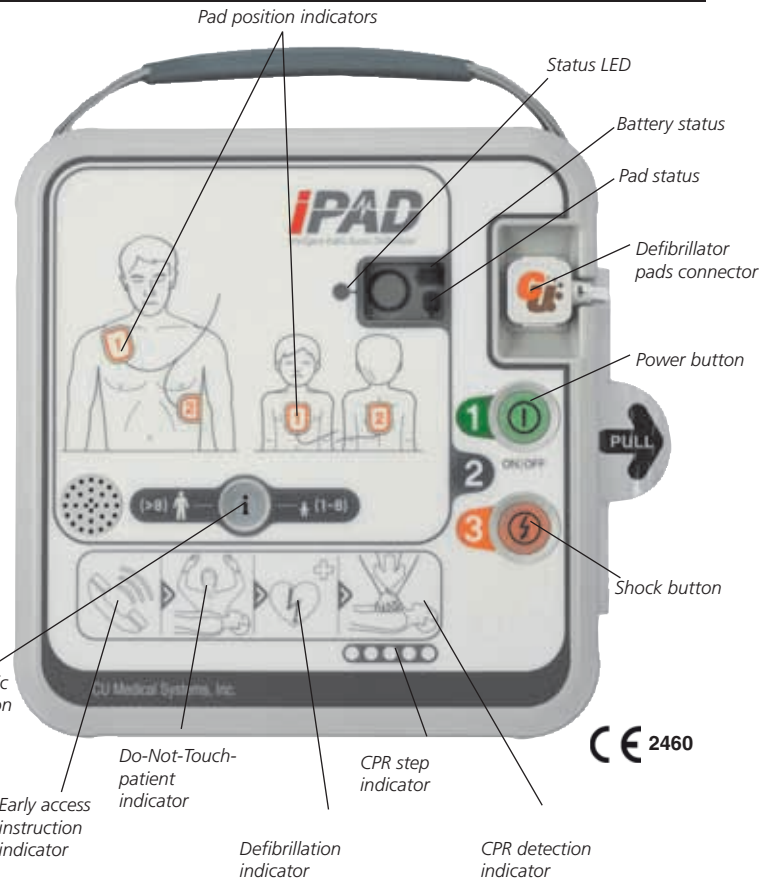

GIMA code	iPAD CU-SPR DEFIBRILLATOR - semi-automatic		
	Model	Software voice	CD Manual
35400	CU-SPR-semiautomatic	US, GB, FR, IT, ES, DE, PL, KR, JP, Arabic	US, GB, IT, ES, DE, PL, KR, FR, Arabic
35401	CU-SPR-semiautomatic	US, HU, CZ, NO, DK, SE, FI, SK, KR	GB, CZ, NO, DK, SK, SE, KR, IL
35402	CU-SPR-semiautomatic	US, PT, GR, RO, LT, NL, RU, UA, KR, TH	US, PT, NL, KR

STANDARD ACCESSORIES		
Adult pads	Disposable lithium battery pack	Paper manual (GB, IT)
Carrying bag	Multilingual CD manual (see above)	

GIMA code	ACCESSORIES FOR CU-SPR
35410	Trainer - selectable software languages
35411	Trainer Defi Pads - kit of 2
35405	Adult/Pediatric PADS - kit of 2 pcs - disposable
35345	Pediatric PADS - kit of 2 pcs - disposable
35406	Disposable lithium battery LiMnO <sub>2</sub> high capacity 4.2 Ah
33423	Wall cabinet with sound alarm 340x335x180 mm
35407	USB memory key

### TECHNICAL SPECIFICATIONS

<b>Defibrillator</b>	semi-automated	Speaker:	provides voice prompts
Operating mode:	e-cube biphasic (Truncated exponential type)	Sound level:	80 ~ 90 dB (±3dB), apart 1m above speaker
Waveform:	device status, battery level and pads status	Beeper:	provides various audible indications
LCD/LED display:	200 J at 50 Ω load for adults	Automatic self test:	"power On Self-Test, Run-time Self-Test Daily, Weekly, and Monthly Self-Test"
Output energy:	50 J at 50 Ω load for children	Manual test:	battery pack insertion test
Charge control:	controlled by an automated patient analysis system	Battery type:	12V DC, 4.2 Ah LiMnO <sub>2</sub> , disposable
Charging time:	within 3 seconds from when the voice instruction, "An electric shock is needed" is issued	Operating time:	at least 150 shocks (200J) for a new battery or 6 hours of operating time
Time from initiation of rhythm analysis:	12 seconds with a new battery (even after the delivery of 15 discharges at 200J)	Battery shelf life:	at least 5 years from the date of manufacture
Time from power on to readiness for discharge:	25 seconds with a new-fully charged battery (even after the delivery of 15 discharges at maximum energy)	Storage:	internal memory: 5 individual treatments, up to 3 hours per treatment
Time from CPR to shock:	at least 6 seconds from the end of CPR to shock delivery	Size - weight:	240x230x70 mm - 2 kg
Disarm:	- patient's heart rhythm changes to non-shockable rhythm - SHOCK button is not pressed within 15 seconds	ECG analysis system	
		Impedance range:	25Ω to 175Ω
		Shockable rhythms:	ventricular fibrillation or fast ventricular tachycardia
		Acquired ECG Lead:	Lead II
		Frequency response:	1 Hz to 30 Hz

# iPAD CU-SP1 INTELLIGENT PUBLIC ACCESS DEFIBRILLATORS

## SEMI-AUTOMATIC

The iPAD CU-SP1 can store up to 5 events with up to 3 hours of ECG analysis.

Adult mode: >8 years or >25 kg  
 Pediatric mode: 1-8 years or <25 kg

## AHA/ERC 2015 GUIDELINES



Pads connector

Adult/pediatric selection switch  
 Adult pads can be used on pediatric patients (1 to 8 years or <25 kg) ensuring that adult/pediatric selection switch is set to pediatric mode

Shock button

## 5 YEARS WARRANTY

35340, 35355-6

## AUTOMATIC



Pads connector

Automatic defibrillator without shock button

35338-9

### SEMI-AUTOMATIC AND AUTOMATIC iPAD CU-SP1 DEFIBRILLATORS

CU-SP1 is the latest generation of intelligent public access defibrillators with innovative features.

#### CU-SP1 Semi-Automated External Defibrillator (AED)

Easy-to-use, small, light and portable semi-automated external defibrillator with battery. The AED automatically reads the patient's electrocardiogram (ECG) and determines if a cardiac arrest, that requires defibrillation, has occurred, so that both medical professionals and general public can easily operate it.

#### CU-SP1 Fully automated external defibrillator (AED)

If connected to a patient, the device acquires and analyses the electrocardiogram (ECG) for the presence of Ventricular Fibrillation or Ventricular Tachycardia (shockable rhythms). If a shockable rhythm is detected, the device automatically charges itself. After charging is completed, the equipment delivers an electric shock automatically. The devices are easy to use, guide throughout rescue operation using voice prompts and indicators (LED and graphical indicators).

#### Features for both models

##### - Auto volume adjustment

It detects ambient noise and automatically adjusts volume of its prompts to make them audible over the background noise.

##### - Smart pads - intelligent storage

The pre-connected "Smart" electrode pads are stored in an easy access compartment on the underside of the unit. This ensures that the iPAD SP1 is always ready to be used in the shortest time possible. In addition, the visual frontal indicator shows if the connected pads are within their life expectancy. The indicator will change when the pads have only 3 months life left before their expiry date giving you time to arrange for replacements. It will change again when the expiry date is reached.

##### - CPR detection

CPR ensures that the casualty has the best chances of survival. The CU-SP1 detects if CPR is being performed with appropriate prompts, if not it encourages the responder to perform it.

##### - Easy communication with CU-EX1 software

Installing CU-EX1 software onto a computer allows you to see and analyze the usage history of the unit. Information such as time of "power on", the casualty's heart rhythm and shocks delivered are all clearly presented.

##### - 25 languages available (to be indicated with order)

Selectable software languages: see below

iPAD CU-SP1 DEFIBRILLATOR - semi-automatic			
GIMA code	Model	Software voice	Manual*
35340	CU-SP1-semiautomatic	US, GB, FR, IT, ES, DE, PL, KR	US, GB, IT, ES, DE, PL, FR, KR, JP, Arabic
35355	CU-SP1-semiautomatic	US, HU, CZ, NO, DK, SE, FI, SK, KR	US, CZ, NO, DK, SE, SK, KR, IL
35356	CU-SP1-semiautomatic	GB, PT, GR, RO, LT, NL, RU, UA, KR	GB, PT, NL, KR
iPAD CU-SP1 DEFIBRILLATOR - automatic			
GIMA code	Model	Software voice	Manual*
35338	CU-SP1-automatic	US, PL, CZ, DK, SE, FI, NO, LT, UA, KR	GB, CZ, DK, SE, NO, KR
35339	CU-SP1-automatic	US, GB, FR, IT, ES, DE, PT, GR, NL, KR	US, GB, IT, ES, DE, PT, NL, KR

\*Languages listed in "Voice", but not in "Manual" have English manual.

### TECHNICAL SPECIFICATIONS

<b>Defibrillator</b>	
Operating mode:	Semi-automatic or Fully-automatic e-cube biphasic (Truncated exponential type)
Waveform:	
Energy:	Adult: nominal 150J between 25 to 175 ohm Infant/child: nominal 50 joules at 50 ohm
Charge control:	controlled by automated patient analysis system
Charging time:	within 10 seconds since voice instruction "an electric shock is needed"
Sealing:	waterjet proof IPX5 per IEC60529 (IP55) dust protected IP5X per IEC60529
Size - weight:	260x256x69.5 mm - 2.4 kg (including pads and battery)
<b>User interface</b>	
User support:	detailed voice prompts and flashing indicators
CPR guidance:	voice prompts for how to perform CPR for adult and child
Controls:	on/off button, "i" button, shock button (only 35340, 35355-6)
Indicator:	LCD display (Device status, Battery status, Pads status)
Sensing:	pads expiry date, Pads connection status
CPR Monitoring	
Automatic Volume adjustment	
<b>Data recording and transmission</b>	
IrDA port / SD card:	for PC communication
Internal Memory Data capacity:	multi recording 5 individual events / Max 3 hours
Data review PC Programme:	CU-EX1
<b>Patient analysis system</b>	
Patient Analysis:	Shockable Rhythms - Ventricular Fibrillation, Tachycardia
Sensitivity/Specificity	Meets AAMI DF80 Guideline
<b>Disposable high capacity battery</b>	
Standard	Type: DC 12 Volt 4.2 Ah, Lithium manganese dioxide
Capacity:	Minimum 200 shocks or 8 hours of operating time
<b>Altitude operating range</b>	
Altitude	0-4,570 m (0-15,000 feet)



GIMA code	ACCESSORIES FOR CU-SP1	
35342	Trainer Defi Pads - kit of 2	
35343	Trainer - 12 selectable software languages** (GB, IT, SE, FI, NO, DK, HU, RU, UA, JP, KR, Arabic)	
35344	Adult PADS - kit of 2 pcs - disposable	
35345	Pediatric PADS - kit of 2 pcs - disposable	
35346	Disposable lithium battery LiMnO <sub>2</sub> , high capacity 4.2 Ah	
33423	Wall cabinet with sound alarm 340x335x180 mm	
35349	SD card+ software for event recording download	
**Other languages available on request (FR, ES, PT, DE, PL, CZ, GR, NL, RO, LT).		
STANDARD ACCESSORIES		
Adult pads	Disposable lithium battery pack	Paper manual (GB, IT)
Carrying bag	Multilingual CD manual (see beside)	

# IPAD CU-SP2 LCD DEFIBRILLATORS: AED AND AED/MANUAL MODE



- **35341 IPAD CU-SP2 DEFIBRILLATOR - AED MODE**
- **35352 IPAD CU-SP2 DEFIBRILLATOR - AED + MANUAL MODE**

**Semi automated mode (35341 and 35352)**  
Semi-automated external defibrillator that can be administered on sudden cardiac arrest (SCA) patients. CU-SP2 is an easy-to-use, small, light and portable defibrillator with battery.

The AED automatically reads the sudden cardiac arrest (SCA) patient's electrocardiogram (ECG) and determines if a cardiac arrest that requires defibrillation has occurred, so that licensed emergency medical technicians, medical professionals and the general public can easily operate it.

**Manual mode (only 35352)**

In manual mode, the user determines whether the patient needs a defibrillation shock or not. It is intended for use by health care professionals and emergency rescue personnel who have been trained in advanced cardiac life support.

**Innovative features:**

**- Auto volume adjustment**

It detects the ambient noise and automatically adjusts the volume of its prompts to make them audible over the background noise.

**- Smart pads - intelligent storage**

The pre-connected "Smart" electrode pads are stored in an easy access compartment on the underside of the unit ensuring use in the shortest possible time. In addition, the visual frontal indicator shows if the connected pads are within their life expectancy. The indicator will change when the pads have only 3 months life left before their expiry date giving you time to arrange for replacements. It will change again when the expiry date is reached.

**- CPR detection**

CPR is vital to ensure that the casualty has the best chances of survival. iPad CU-SP2 detects if CPR is being performed with appropriate prompts, if not it encourages the responder to perform it.

**- Easy communication with CU-EX1 software**

It allows to see and analyze information such as time of "power on", the casualty's heart rhythm and shocks delivered. It saves 3 events on the internal memory (up to 17 hours per event).

**- Wireless ECG transmission device (CU-EM1) - optional**

In monitor mode, iPad CU-SP2 uses Bluetooth to receive ECG data from CU-EM1 and displays it on the LCD screen.

**- Printer - optional**

iPAD CU-SP2 supports connection to an external Bluetooth printer.

**- Selectable software in 16 languages**

GB, FR, IT, ES, DE, PT, NL, SE, PL, FI, DK, NO, CZ, GR, UA, KR. All languages have their own user manual except NL, SE, UA, FI, that have English user manual

STANDARD ACCESSORIES		
Adult PADS	Disposable Li-ion battery pack	Paper manual (GB, IT)
Carrying bag	CD manual in above languages	

TECHNICAL SPECIFICATIONS	
<b>Defibrillator</b>	
Operating mode:	Semi-automatic (35341, 35352), manual (35352)
Waveform:	e-cube biphasic (Truncated exponential type)
Energy:	AED mode: 150/200J fixed or 150-150-200J energy escalating Manual mode: 2-200J, R-Sync (only 35352)
Charging time:	within 10 seconds
Charging time after CPR finished:	at least 6 seconds
Sealing:	waterjet proof IPX5 per IEC60529 (IP55) dust protected IP5X per IEC60529
Size - weight:	260x256x69.5 mm - 2.4 kg (including pad and battery)
<b>User interface</b>	
User support:	detailed voice and text prompts
CPR guidance:	voice prompts for how to perform CPR for adult and child
Controls:	on/off button, "i" button, shock button, soft keys
Indicator:	graphic LCD display (status, user's guide, ECG, heart rate, ....)
Sensing:	pads expiry date, pads connection status
CPR Monitoring, ECG Monitoring, Automatic Volume adjustment	
<b>Data recording and transmission</b>	
IrDA port SD card:	for PC communication
Internal Memory (Nand-flash):	ECG, Event
Storage capacity:	multi recording 3 events / Max 17 hours for each event
Bluetooth:	communication with the printer or ECG CU-EM1
Data review PC Programme: CU-EX1	
<b>Patient analysis system</b>	
Patient Analysis:	Shockable Rhythms (Ventricular Fibrillation, Tachycardia)
Sensitivity/Specificity	meets AAMI DF80 Guideline
<b>Battery</b>	
Standard	Type: DC 12 Volt 4.2 Ah, Lithium manganese dioxide Capacity: Minimum 130 shocks (150J) or 5 hours ECG monitoring
Rechargeable (optional)	Type: DC 11.1 Volt 1.9 Ah, Li-ion rechargeable Capacity: Minimum 60 shocks or 3 hours of operation
<b>Altitude operating range:</b>	
Altitude	0-5,000 m

GIMA code	ACCESSORIES FOR CU-SP2
35344	Adult PADS - kit of 2 pcs - disposable
35345	Pediatric PADS - kit of 2 pcs - disposable
35346	Disposable Lithium battery LiMnO <sub>2</sub> high capacity 4.2 Ah - spare
35347	Rechargeable 10.8 V, 2.5 Ah Li-ion battery - optional
35348	Battery charge dock + battery charger for 35347
35349	SD card+ software for event recording download
35350	Wireless ECG CU-EM1 for CU-SP2
35351	Wireless printer for CU-SP2

# PRIMEDIC™ EXTERNAL DEFIBRILLATORS - AED

PRIMEDIC HeartSave product range is easy to operate and offers fast operation. Clear voice prompts guide first aiders through the rescue procedure.

### Current controlled defibrillation - CCD

CCD Biphasic technology delivers peak-free current defibrillation on the patient's heart muscle through its individualized, gentle, effective and current-controlled defibrillation pulse. Featuring an escalating defibrillation strategy, HeartSave is impedance compensated and capable of a maximum energy of 360J.

### Effective workflow

Designed to help first aiders delivering the most effective life support. Through its advanced workflow, HeartSave supports the rescuer in minimizing the perishock pause as well as no-flow fraction.

### Pediatric mode

At a touch of a button the Paediatric Mode can be promptly selected. No need of dedicated paediatric electrodes and extreme ease of use result in optimized costs of maintenance and prompt operation.

### Fast

It turns on automatically as soon as the cover has been opened and rhythm analysis starts immediately as the pre-connected electrodes are attached to the patient. All accessories (razor, breathing mask, scissors and gloves) are included.

### Status display

Active status display provides comprehensive information on the device's operating status and battery status (daily and monthly self-tests).

### HEARTSAVE PAD and HEARTSAVE AED

Automatic external defibrillator with 3 years life (PAD) or 6 years life (AED) in standby mode with non rechargeable lithium battery.

The HeartSave AED has 4 selectable languages.

### HEARTSAVE AED-M

Same features as HeartSave AED, plus large LCD display for ECG waveform, HR, shockable rhythm counts and other relevant information. AED-M is supplied with non rechargeable lithium battery.



**PRIMEDIC**  
Saves Life. Everywhere.

High resolution LCD monitor gives important information for resuscitation



Connection socket for save pads and ECG cable

Size approx 26x26x8.5 cm

Menu button

33396

Trigger button for real single-button operation. You can save a life with only one button.

Status display

EN 1789

**AHA/ERC GUIDELINES 2015 CONFORMITY**

MADE IN GERMANY

**IP55 WATER-CLASS-PROTECTED**

HEART SAVE EXTERNAL DEFIBRILLATORS		Voice version and manual			
	<b>WITH LITHIUM BATTERY</b> <b>140 DISCHARGES AT 360J</b> <b>3 YEARS STANDBY</b>	Italian	English	French	Other languages**
	HeartSave PAD	33393	33395	33398	33402

\*\*We can provide following languages (manual+voice): GB, FR, IT, ES, PT, DE, GR, NL, PL, RO, HU, CZ, DK, LT, SE, RU, (voice only): HR, FI, NO, SI, SK, BG, IL, IS, MK, TR, AE, KR, IR, TH, KT, CN.

AED		Voice version and manual			
	<b>WITH LITHIUM BATTERY</b> <b>200 DISCHARGES AT 360J</b> <b>6 YEARS STANDBY</b>	English Spanish Greek Portuguese	Italian French German English	Italian French German Polish	Other languages***
	HeartSave AED HeartSave AED-M	33391 33396	- 33397	33392 -	33394 33399

WITH AKUPAK LITE RECHARGEABLE BATTERY AND CLIP CHARGER		Voice version and manual		Other languages***	
		English Italian Spanish French			
	HeartSave AED-M	33440			33446

\*\*\*We can provide following languages (voice + manual): BG, CZ, DK, FI, HR, HU, MK, NL, NO, RO, RU, SE, SI, TR, AE, CN, IR, TH. Please specify with order. Available in 40/60 days.

SAVEPADS FOR HEART SAVE		GIMA code
Self-adhesive electrode, cable, razor and gloves - shelf life 3 years		
SavePads mini for 1-8 years max 25 kg		35390****
SavePads preconnect set adult/child minimum 1 year		35392****
<i>Since S. N. 739xxxxxxx</i>		
SavePads for over 8 years 25 kg Only for 33384/5 and AED sold before April 2014 up to S.N. 738xxxxxxx		33388****
****Multilingual pack (35 languages)		

ACCESSORIES - SPARES		GIMA code
Lithium BATTERY - not rechargeable life 6 years for AED and AED-M		33387
AkuPak Lite Rechargeable battery*****		33400
PowerPak Battery charger for code 33400		33407
*****For AED-M and HeartSave		

STANDARD ACCESSORIES	
Lithium battery, 3 years stand-by (140 shocks @360J), (PAD only)	
Lithium battery, 6 years stand-by (200 shocks @360J), (AED, AED-M)	
AkuPak Lite, rechargeable battery with clip charger, (AED-M)	
SavePads	
Data and voice recording	
Manual	

\*AED-M is available with lithium battery or with Akupak Lite rechargeable battery. Select code for requested model

	TECHNICAL SPECIFICATIONS				PAD	AED	AED-M
	PAD	AED	AED-M				
<b>Defibrillation</b>							
Semi-automatic mode	•	•	•				
Wave: biphasic, current controlled pulse	•	•	•				
Energy 50-360J	•	•	•				
Charging time: < 12 sec @ 360J	•	•	•				
Operating modes: asynchronous	•	•	•				
Paediatric mode	•	•	•				
<b>ECG</b>							
Lead: II			•				
Patient's impedance range: 23-200 Ohm	•	•	•				
Heart rate: 30-300 per min			•				
<b>VF:VT Detection</b>							
VF/VT Detection	•	•	•				
Analysis time 7-12 sec	•	•	•				
Asystole threshold <0.2mV	•	•	•				
Artefact-Pacemaker detection	•	•	•				
<b>Electrodes</b>							
Non polarized electrodes, cable length 2 m	•	•	•				
				<b>LCD Monitor</b>			
				95x72 mm (diagonal 4.7"/120 mm)			•
				320x240 (pixel size 0.36x0.36 mm)			•
				Storage battery status display			•
				Speed 25 mm/s			•
				Heart rate, number of defibrillation, number of VF/VT, total resuscitation time			•
				<b>Data backup</b>			
				Removable memory	•	•	•
				Voice recording	•	•	•
				<b>Power supply</b>			
				Lithium battery 3 years life or 140 discharges at 360J	•		
				Lithium battery 6 years life or 200 discharges at 200J		•	•*
				- 15 hours monitoring			
				AkuPak Lite with rechargeable battery			
				100-240 V, 50/60 Hz - 150 discharges at 200J			••
				- 5 hours monitoring			
				<b>Status display</b>			
				Defibrillator and battery status visualization	•	•	•

\*33396/79

\*\*33440, 33446

# PRIMEDIC DefiMonitor XD - PROFESSIONAL DEFIBRILLATORS

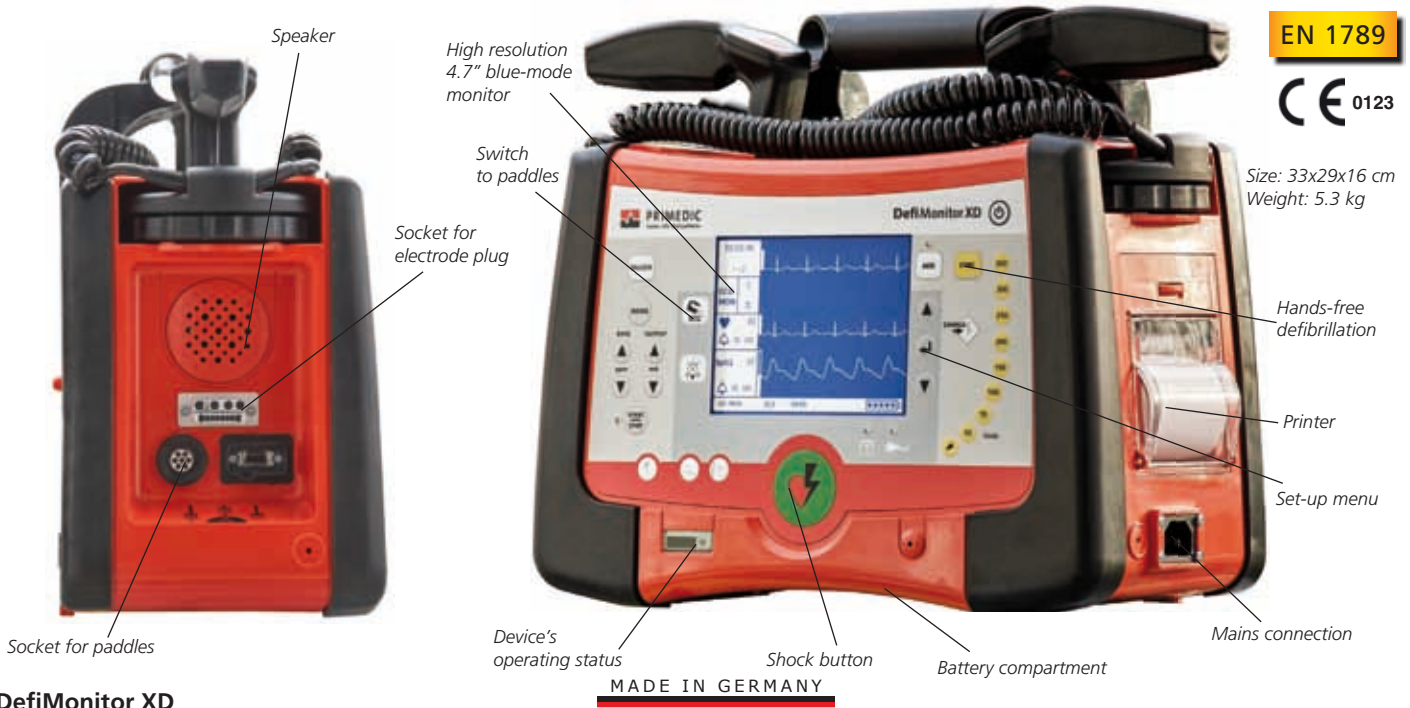

## DefiMonitor XD

The sophisticated high performance instrument with multifunctional features. It combines a compact product design, proved and tested in practice with the highest possible degree of safety and user friendly handling. 6 lead ECG with free choice of leads and synchronous display of two curves on monitor. Range of 8 manual or manual + AED defibrillators with or without SpO<sub>2</sub> and external pacer. Supplied with adult/pediatric paddles, disposable adult Save Pads, connecting cable, ECG cable, power cable, 1 tube of gel, 1 paper roll, battery. Standard software: GB, FR, DE, IT, ES, KT, PT, RO, TR, CN. Manual: GB, IT (on request DE, ES, PT, RU, UA). Other softwares available on request: CZ, FI, HU, NL, NO, PL, RU, SE, DK, GR, LT, JU, AE, BR, CN, IR, JP, TH, US.



Using reliable bayonet mechanism, adult paddles can be transformed into children's paddles, without requiring adapters.

GIMA code	DefiMonitors XD
35370	DefiMonitor XD manual
35371	DefiMonitor XD manual + SpO <sub>2</sub>
35372	DefiMonitor XD manual + pacer
35373	DefiMonitor XD manual + SpO <sub>2</sub> + pacer
35374	DefiMonitor XD manual + AED
35375	DefiMonitor XD manual + AED + SpO <sub>2</sub>
35376	DefiMonitor XD manual + AED + pacer
35377	DefiMonitor XD manual + AED + SpO <sub>2</sub> + pacer

GIMA code	Accessories for DefiMonitors XD
35380	SavePads Connect - multilingual GB, FR, IT, ES, DE, PT, NL, GR, RO, PL, SK, HU, BG, CZ, LV, LT, NO, FI, DK, SE, RU, TR, ID, JP, Arabic (require cable 35384)
35384	Connecting cable for SavePads Connect 35380/3 - spare
33400	AkuPak LITE XD rechargeable battery
35387	Paper roll 58 mm x25 m - box of 10
35388	DefiMonitor carrying bag with shoulder strap

	TECHNICAL SPECIFICATIONS																
	35370	35371	35372	35373	35374	35375	35376	35377									
<b>Defibrillation</b>									<b>TFT LCD blue-mode monitor</b>								
Wave: biphasic, current controlled impulse	•	•	•	•	•	•	•	•	115x86 mm (diagonal 5.7"/144 mm)	•	•	•	•	•	•	•	•
Energy (automatic mode) 140-360 J	•	•	•	•	•	•	•	•	320x240 pixels	•	•	•	•	•	•	•	•
Energy level (biphasic):									<b>Electrodes</b>								
2, 5, 7, 10, 20, 30, 50, 70, 100, 150, 200, 250, 300, 360 J	•	•	•	•	•	•	•	•	Adhesive electrodes, 3 years shelf life	•	•	•	•	•	•	•	•
Charging time: < 6 sec at 200 J	•	•	•	•	•	•	•	•	Cable length 3.5 m Save pads connect	•	•	•	•	•	•	•	•
Cardio version: manual activation, QRS marker	•	•	•	•	•	•	•	•	<b>Data backup</b>								
<b>ECG</b>									Removable memory 2 GB	•	•	•	•	•	•	•	•
Derivation: Einthoven I, II, III	•	•	•	•	•	•	•	•	Data/Voice recording up to 35 h	•	•	•	•	•	•	•	•
Goldberger, aVR, aVF, aVL	•	•	•	•	•	•	•	•	<b>Power supply</b>								
Patient's resistance: 23-200 Ohm	•	•	•	•	•	•	•	•	Voltage 90-264 V, 50/60 Hz	•	•	•	•	•	•	•	•
Heart rate: 30-300 per min	•	•	•	•	•	•	•	•	<b>Rechargeable Lithium-ion battery:</b>								
<b>VF: recogniton</b>									Capacity 2.5 Ah Voltage: 13.2 Vdc	•	•	•	•	•	•	•	•
VF recogniton									Discharges 160-200 J	•	•	•	•	•	•	•	•
Analysis time 7-12 sec	•	•	•	•	•	•	•	•	Monitoring 5.30 h Charging time: 3.2 h	•	•	•	•	•	•	•	•
VF threshold 200 µV	•	•	•	•	•	•	•	•	<b>Resuscitation guidelines</b>								
Asystole threshold < 200 µV	•	•	•	•	•	•	•	•	AHA/ERC	•	•	•	•	•	•	•	•
Artefact, Pacemaker detection	•	•	•	•	•	•	•	•	<b>Standards</b>								
<b>Pulse Oximeter</b>									IEC60601-1:1988+A1:1991+A2:1995	•	•	•	•	•	•	•	•
Nellcor Oximax	•	•	•	•	•	•	•	•	(Electrical Safety of Med. Electrical Devices)	•	•	•	•	•	•	•	•
<b>Pacer</b>									IEC60601-1-2:2001 (Electromagnetic compatib.)	•	•	•	•	•	•	•	•
Transthoracic heart pacemaker	•	•	•	•	•	•	•	•	IEC60601-1-4:1996+A1:1999	•	•	•	•	•	•	•	•
Modes: fix, demand, overdrive	•	•	•	•	•	•	•	•	(Programmable electrical medical systems)	•	•	•	•	•	•	•	•
<b>Thermal printer</b>									IEC60601-2-4:2002 (Defibrillators)	•	•	•	•	•	•	•	•
Resolution: 200 dpi	•	•	•	•	•	•	•	•	EN1789:2003 (Ambulance standard)	•	•	•	•	•	•	•	•
Advance: 25 mm/s, 50 mm/s	•	•	•	•	•	•	•	•	Protection class IP33	•	•	•	•	•	•	•	•

# RESCUE LIFE 7" MANUAL AND SEMIAUTOMATIC DEFIBRILLATORS

Large, bright, high contrast, wide-angle TFT LCD colour display 7" to view simultaneously up to 12 ECG channels

**AVAILABLE WITH:**  
 - SpO<sub>2</sub>  
 - NIBP  
 - PACEMAKER  
 YOU MAY ORDER UNIT WITH 1 TO 3 OF ABOVE PARAMETERS

**Fast connection.**  
 User can choose between ergonomic reusable paddles for manual defibrillator or disposable pads for AED defibrillation. Both types are equipped with a single fast lock connection for reliable rescue operations.

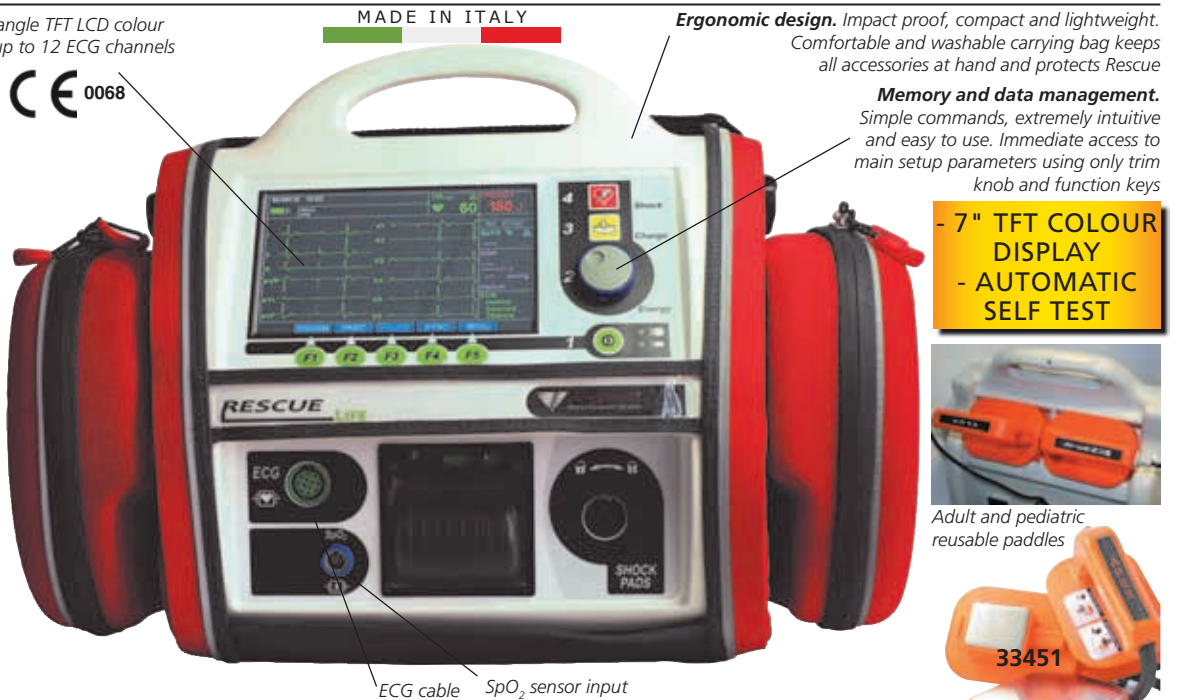

## RESCUE LIFE BIPHASIC DEFIBRILLATORS 7"

Rescue Life is an external defibrillator with monitor. It is designed to be used by out-of-hospital and hospital users. Lightweight, transport facility, attractive line, ergonomic shape, studied in every details. It is a complete acute cardiac care response system designed for Basic Life Support (BLS) and Advanced Life Support (ALS) patient management protocols.

### SpO<sub>2</sub> and Pacemaker

Range includes models with pacemaker and SpO<sub>2</sub>. ECG module for monitoring (not for diagnosis) includes up to 12 derivations standard 5 leads patient cable (for I, II, III, aVL, aVR, aVF) or optional 10 leads patient cable (for 12 derivations).

### NIBP

The NIBP option is focused on advantage A+ module of SunTech Medical that provides the highest NIBP performance during movements. Suitable for adult, pediatric and neonatal.

### High contrast TFT LCD colour display 7"

Bright, high contrast, wide-angle colour display for simultaneous view of up to 12 ECG channels

### Data management

The memory is based on a flash disk of 4 GB for 300 recorded hours for all AED models

### Asynchronous and synchronous

- in *asynchronous* defibrillation, Rescue is advised on patients with the following symptoms: unconsciousness, absence of normal breathing and lack of detectable pulse.

- in *synchronous* defibrillation, Rescue Life is advised on patients with ECG's reporting Atrial Fibrillation.

### 3 operation modes: manual, AED, Advisory

- in *manual mode* RESCUE LIFE is intended for use by doctors and trained individuals. Only 3 steps: energy selection from 1 to 230J, energy charge and shock.

- in *AED mode*, RESCUE LIFE is intended for use by personnel authorized by a physician or medical director. The voice prompts and display messages are assisting the operator during CPR operations, charging automatically to 150J when a shock-able ECG rhythm is detected.

- in *advisory Mode*, the system alerts when the shock is necessary leaving the energy level and charging choice to the operator.

### Initialising and system test at switching on of the device

Auto test and fault recognition.

### Clinical test

Available on our web site.

STANDARD ACCESSORIES	
Internal Li-Ion battery	1 paper roll
2 adult and pediatric reusable paddles	Patient cables 5 leads
Manual: GB, IT	2 disposable pads
Printer	Main adaptor charger

English	Italian	Other languages*	RESCUE LIFE 7" DEFIBRILLATORS
33185	33186	33187	Rescue life AED defibrillator
33191	33192	33193	Rescue life AED defibrillator SpO <sub>2</sub> +Pacemaker
33194	33195	33196	Rescue life AED defib. SpO <sub>2</sub> +NIBP+Pacemaker
33188	33189	33190	Rescue life AED defib. other configuration**

\*On request we can offer Rescue Life AED in Spanish and French

\*\*On request we can offer Rescue Life AED with SpO<sub>2</sub>+NIBP; SpO<sub>2</sub>+Pacemaker (available in GB, FR, IT, ES)

GIMA code	RESCUE LIFE ACCESSORIES
33461	Disposable paddles - box of 2 - adult - spare
33458	Disposable paddles with cable - box of 2 - pediatric
33593	Cable for disposable paddles- spare for 33458, 33461
33594	ECG cable 10 leads
33595	Rescue Life bag
33250	Thermal paper
33596	12V car light adapter - inverter

## TECHNICAL SPECIFICATIONS

### Display:

- high contrast TFT colour or LCD 7" (800x480 dots)
- ECG through the discharge paddles (1 trace) or through 5, 10 leads patient cable for 3, 6, or 12 traces and SpO<sub>2</sub> value
- Automatic change over when plugging the patient cable
- filters: 50/60 Hz, base line, EMG
- heart rate indicator

### ECG monitoring

- bandwidth: 0.5 to 120 Hz (-3db) with filters off
- speed: 5, 10, 25, 50 mm/sec.
- gain: 2.5, 5, 10, 20, 40 mm/mV with patient cable; auto with paddles
- HR digital readout on the display 20 to 300 bpm (± 2%)
- alarm: settable HR, min 20 bpm, max 250 bpm

### Pulse oxymetry (SpO<sub>2</sub>) 33188-33196

- oxygen saturation range: 0 to 100%
- pulse rate range: 30 - 220 pulses per minute
- accuracy SpO<sub>2</sub>: 70-100% ± 2 digits for adults using the finger clip sensor
- SpO<sub>2</sub> Alarms adjustable (min. 50%)
- Non-invasive pacemaker (33188-33196)
- rectangular wave
- operating mode: fixed on demand
- pulse rate: 30 to 150 ppm adjustable in steps of 5 ppm
- impulse duration: 22 ms
- pulse Current: 0 to 150 mA adjustable in steps of 5 mA

### - amplitude: MAX 150 V

### NIBP (33188-33190, 33194-33196 only)

- technique: oscillometric
- accuracy: meets ANSI/AAMI SP10-2002, EN 1060-4
- patient application: adult/pediatric/neonatal
- range mmHg

	adult	pediatric	neonatal
systolic	40-260	40-160	40-130
MAP	26-220	26-133	26-110
diastolic	20-200	20-120	20-100

### Printer:

- manual, automatic (10" pre and post recording)
- integrated thermal printer for ECG traces and events documentation including HR/SpO<sub>2</sub> NiBP values
- paper speed: 5, 10, 25, 50 mm/sec.
- paper width: 58 mm

### Safety:

- two hand safety shock release
- ECG input insulation CF class
- internal discharge after 30 sec. of standby after charge

### Power supply:

- internal Li-Ion battery (charging time 95%: 2 hours)
- AC 100-240 VAC, 50/60 Hz
- Memory: internal flash 4 GB up to 300 hours of ECG data, events and usage review

### General:

- Dimensions: 36x24x34 cm
- Weight: 5.5 kg with battery

# RESCUE LIFE 9" MANUAL AND AED DEFIBRILLATORS

**High-resolution TFT LCD colour 8.4" 800x600 dots display**

Brilliant and impact proof display allows the simultaneous visualization in real time of 3, 6 or 12 leads ECG and plethysmograph waveform with SpO<sub>2</sub> sensor connected

**Fast connections**

Users can choose between ergonomic reusable paddles, suitable for the manual defibrillation in both adult and pediatric patients or disposable pads for AED defibrillation. Both types are equipped with a single fast lock connection for reliable rescue operations

**YOU MAY ORDER WITH 1 TO 3 OF BELOW PARAMETERS:**  
**SpO<sub>2</sub>, NIBP, PACEMAKER**  
 INTEGRATED  
**EtCO<sub>2</sub> and Temp Configurations**



**Memory and data management**  
 Simple commands, extremely intuitive and easy to use. Immediate access to main setup parameters using only the trim knob and function keys. Internal memory to record ECG data and events

**- 8.4" TFT LCD COLOUR DISPLAY - AUTOMATIC SELF TEST**

**AED & Advisory mode**  
 Simple step 1-2-3 supports the operator during use in AED mode. Voice prompts and visual messages guide the procedure of CPR and release the shock. Advisory mode automatically and continuously analyzes the ECG rhythm with ECG cable or pads connected to patient and finally it advises if the shock is necessary.

**RESCUE LIFE DEFIBRILLATOR 9"**

Designed for an out-of hospital and hospital use. Lightweight, ergonomic, attractive and robust portable device. Rescue Life 9 provides complete monitoring of parameters like 12 channels ECG, HR, SpO<sub>2</sub>, NIBP, Temperature and EtCO<sub>2</sub>. Synchronized cardioversion and external pacemaker in fixed or demand mode. Three operating modes: manual, AED, Advisory. Capnography waveform. Auto-test mode verifies device functions, battery status and charge-discharge system with real time data management and report printing.

**Temperature and EtCO<sub>2</sub> (optional)**

It includes: temperature and EtCO<sub>2</sub> configuration. Optional Temp sensor and EtCO<sub>2</sub> module can be added anytime.

**Dual battery: one included, one optional**

The powerful battery is up to 5 hours continuous monitoring. Second battery improves working time operation to 10 hours and avoid process disruption.

Batteries can be easily replaced by the operator.

**High resolution TFT LCD colour 8.4" display**

**Intelligent Operator Support**

Display shows visual messages, different colours for each function, clear voice support during difficult situations and simple menu with dedicated functions keys.

**ECG Analysis in two modes**

ECG signal can be filtered through diagnostic mode, which collects ECG traces for qualified personnel interpretation and diagnosis; monitoring mode, which removes noises caused by patient's movements or body physiological process.

**AED & Advisory mode**

AED mode: operators are supported by voices and messages in CPR and shock release. Advisory mode automatically and continuously analyzes ECG rhythm and the connection of cable and pads on patient, and tells if the shock is necessary.

**Memory and Data Management + Software**

Recorded ECG data and events can be transferred and managed on PC through a software which can be freely downloaded.

**Other features:**

- alarms for each single function
- automatic report before and after the shock release
- ergonomic reusable pads for manual defibrillation, disposable pads for AED defibrillation.

MADE IN ITALY

**STANDARD ACCESSORIES**

- 1 internal Li-Ion battery
- 5 leads Patient cable
- 1 adult and pediatric reusable paddles set
- 1 disposable adult pads set
- Printer with 1 paper roll
- Main adaptor charger
- Adaptor cable for disposable pads

English	Italian	Other Languages*	RESCUE LIFE 9" DEFIBRILLATORS
55500	55501	55504	Rescue Life 9" basic + AED
55505	55506	55509	Rescue Life 9" basic+AED+SpO <sub>2</sub> +PM
55510	55511	55514	Rescue Life 9" basic+AED+SpO <sub>2</sub> +PM+NIBP

\*French, Spanish, specify with order Manual: GB or IT or FR or ES

GIMA code	RESCUE LIFE 9" ACCESSORIES
33461	Disposable paddles - adult - box of 2 - spare
33458	Disposable paddles with cable - pediatric - box of 2 - spare
33593	Adaptor cable for disposable paddles - spare for 33458, 33461
33594	ECG cable 10 leads - optional
55520	Rescue Life 9" bag
55521	Kit EtCO <sub>2</sub> (sensors and cable) - optional
55522	Battery - spare
33250	Thermal paper - spare
33596	12V car light adapter - inverter

**TECHNICAL SPECIFICATIONS**

<b>General requirements:</b>	Input: Patient cable 5 leads (I, II, III, aVL, aVF, aVR, V) - standard Patient cable 10 leads (I, II, III, aVL, aVF, aVR, V1.....V6) - optional
Dimension: 335x225x360 mm	Speed: 5, 10, 25, 50 mm/sec
Weight: 6.5 kg with dual batteries	Filters: 50/60 Hz, EMG Filter, base line
Electrical: AC 100-240 VAC, 50/60 Hz	HR range: 20-300 bpm (~2%), digital readout on the display
Rechargeable Lithium-ion batteries: 15.0 V - 3.2 Ah	Alarm: HR max settable 250 bpm; HR min 20 bpm
Battery Operation Time: >5 hours, with 1 battery >10 hours with 2 batteries	<b>SpO<sub>2</sub> (only 55505-55514)</b>
Charge Time: Max. 3 hours	SpO <sub>2</sub> range: 0-100% HR range: 30-250 bpm
Capacity: 150 shocks with 1 battery or 300 shocks with 2 batteries at 230J fully charged	Accuracy: 70-100% ~2% for adults with finger clip sensor
Software: Voice and texts multi language	Alarm: Adjustable min 50%
Memory: Internal flash for ECG data, events and usage review	<b>Oscillometric NIBP (only 55510-55514)</b>
<b>Defibrillation</b>	Accuracy: Meets ANSI/AAMI SP10-2002, EN 1060-4
Waveform: Biphasic Truncated Exponential (BTE), HiCAP technology (Large storage capacitor)	Application: Adult / Paediatric / Neonatal (mmHg)
Impedance: Compensated, range 25-200 Ohm	Systolic Range: 40-260 40-160 40-130
Charge time: 6 sec for 230 J with battery fully charged	Range MAP: 26-220 26-133 26-110
<b>AED mode</b>	Diastolic Range: 20-200 20-120 20-100
Energy: Fixed energy at 200 J	PR range: 30-220 bpm ±2% or ±3 bpm
Protocol: ERC 2015 CPR Guidelines with voice and text prompts	Operating Modes: Manual, Long Term Automatic, Stat, Service
Shockable rhythms: VF with amplitude > 0.15 mV and VT with rhythm >150 bpm	Auto Interval Periods: 1,2,3,4,5,10,15,30,60 and 90 minutes
Sensitivity: Shockable rhythm -VF > 95%, -VT > 75%	<b>Integrated thermal 3 channels printer</b>
Specificity: According to ERC 2015, Normal sinusoidal rhythm > 99% Asystole and other non-shockable rhythms > 99%	Paper speed 5, 10, 25, 50 mm/sec Paper width: 58 mm
<b>Manual mode</b>	Mode: Manual, automatic (12" pre and post shock recording)
Energy range: 1-230 J (from 1-10 J in 1 J steps; from 10 to 230 J in 10 J steps)	<b>External pacemaker (only 55505-55514)</b>
Commands: Multifunction trim knob Charge and shock button in the front panel	Type: Rectangular wave
Operating mode: ECG «R» wave synchro or async mode	Operating mode: Fixed on demand
Indicators: Battery and main led indicators	Pulse rate: 30 to 250 ppm, adj. in steps of 5 ppm
<b>Display</b>	Impulse duration: 22.5 ms
Type: High contrast TFT colour LCD 8" (800x600 dots)	Pulse current: 0 to 180 mA adj. in steps of 5mA
Information: ECG traces, SpO <sub>2</sub> , NIBP, EtCO <sub>2</sub> , TEMP, Heart Rate indicator, filters, alarms and batteries status	Amplitude: Max 200 V
Display mode: Can select 3, 6, 12 ECG leads	<b>Mainstream technology Entidal CO<sub>2</sub> (optional)</b>
<b>ECG monitoring</b>	Suitable for both intubated and non-intubated patients
Bandwidth: 0.05 - 120 Hz (-3 db) in diagnostic mode 0.6 - 40 Hz (-3 db) in monitoring mode	Measurement range: 0 to 150mmHg ±2%
CMRR: > 98 dbv	Respiratory rate: 0 to 150 bpm
	<b>Temperature (optional)</b>
	Probe type: YS1400 compatible
	Range: 0 to 50° C Resolution: ±0.1° C
	<b>Standard</b>
	IEC 60601-2-4; IEC 60601-1; IEC 60601-1-2; IEC 63204, IEC 62366-1
	CE Mark EEC 93/42: Medical device, Class IIb
	Isolation: ECG type CF, Defibrillation type BF
	Water proof: Class IPX4



# AMBU® TRAINING MANIKINS

Features	AmbuMan School	Ambu Uniman+	AmbuMan Basic	AmbuMan Airway Instrument	AmbuMan Airway Wireless	AmbuMan Advanced (+ IV)
Mouth to Mouth ventilation	•	•	•			
Mouth to nose ventilation	•	•	•			
Bag-valve-mask ventilation		•	•	•	•	•
Use of Guedel airways				•	•	•
Airway management: Et tube, laryngeal tube & mask and other SGAs				•	•	•
Jaw-thrust manoeuvre		•	•	•	•	•
Gastric insufflation				•	•	•
Ambu hygiene system	•	•	•			
Insufflation bag (Ambu hygiene system)	20	25	25			
Manikin face mask (Ambu hygiene system)	•	•	•			
Chest compression	•	•	•	•	•	•
Max compression depth (cm)	6	7.5	7.5	7	7	7
Max insufflation - litres	0.4	1.8	1.2	1.2	1.2	1.2
Hand position display		•	•	•	•	•
Infinitely adjustable chest stiffness				•	•	•
Pulse				manual	manual	electrical
Placement of defibrillation electrodes	•	•	•	•	•	•
Defibrillation						•
I.V. access - need IV trainer 34041				optional	optional	optional
Wireless CPR software					•	•
ECG display						•
Carrying bag	carton box	•	•	•	•	•
Weight (kg)	0.8	4.5	6.0	13	13	13.3
Multilingual manual-languages*	17	17	12	10	10	19

\*All manikins have multilingual manual in: GB, FR, IT, ES, PT, DE, DK, HU, PL. 34040, 34045, 34046, have also: CZ, GR, NO, SE, SI, TR, JP, CN. 34042, 34048 have also NL. 34045 has also FI.

## • 34045 AMBU® MAN SCHOOL

Training manikin for education in school of all procedures for basic life support resuscitation. It can be used for realistic training of external chest compressions and the placement of AED pads. The unique hygienic system prevents cross contamination when demonstrating and training of the principals of ventilation through mouth and nose.

### Guideline conform

It allows to perform CPR training following the latest international CPR guidelines.

### Compact and portable

It has a low weight and compact packaging.

### Easy AED training

Due to the closed shaped torso, defibrillation pads can be placed to perform a realistic AED training.

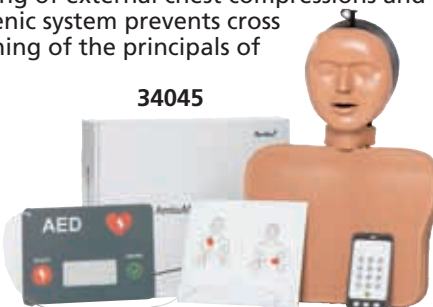

## • 34046 AMBU® UNIMAN+

Inexpensive training manikin with all the well-known and sought-after Ambu look-listen-feel features. The closed shape of the torso with its anatomical correct landmarks enables students to learn the complete algorithm of Basic Life support, including the use of Automatic External Defibrillators (AED) and the placement of the AED Pads.

### Open Airway

The airway is opened only when the head is tilted - there are realistic airway resistance and chest rise.

### Hygienic System

Unique patented hygienic solution as the Ambu Man with disposable head bags and washable face pieces.

### Compact Bag

The head of the Ambu Uniman+ can be placed inside the manikin. Everything is packed in a small bag.

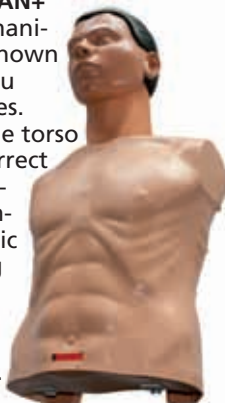

34046

## • 34047 AMBU® MAN BASIC

Cost efficient and reliable training manikin designed to fulfill all requirements for the BLS algorithm training. The closed shaped torso with its anatomical correct landmarks allows trainees to learn and train the use of Automatic External Defibrillators (AED) and the placement of pads. It allows an optimal training of chest compression and ventilation with realistic resistance and expiration through mouth and nose. The unique hygienic system prevents cross contamination. The correct compression depth and required ventilation volume can be monitored by the feedback indicator on the manikin.

### Ventilation as in real life

The trainees will feel the realistic airway resistance and the chest will start rising when the head is correctly tilted and air blown into the manikin. Size: 70x37 cm.

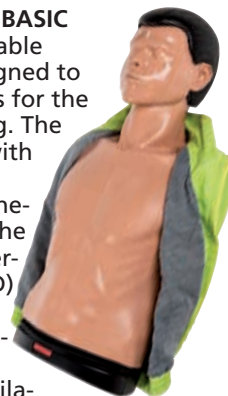

34047

### • 34039 HEAD BAG - box of 100 pcs

## • 34040 AMBU® MAN ADVANCED

Professional training manikin made to fulfil all the needs of Advanced Life Support (ALS) training. The focus of the manikin is on the algorithm: Airway Management, ECG simulation, defibrillation and the training of i.v. access technique. Integrated Ambu Wireless Technology: the browser-based Ambu Manikin Management Module allows the wireless control, documentation and monitoring of the trainee's performance through the central interface, where all data and information come together: compression depth, correct hand position, ventilation volume, stomach inflation.



34040  
34041

### Customised scenario training

The intuitive user interface allows a quick and easy creation of custom scenarios and adapt them to different course concepts, in accordance to the demand of instructors and the current ERC / AHA guidelines. The CPR parameters and manual events are documented wirelessly and included into the evaluation and debriefing.

### Individual trainee evaluation in group

More efficient training, each participant receives his personal results (up to four participants).

### • 34041 AMBU IV TRAINER

### • 34029 BATTERY PACK

## • 34042 AMBU® MAN AIRWAY I

## • 34048 AMBU® MAN AIRWAY W with CPR

Adult-sized training manikins that provide an optimal lifelike representation of the human anatomy. Instant feedback on ventilation volume, stomach inflation, chest compression depth in mm and wrong hand position. PC connection (34048 only) of Ambu CPR Software Kit, Ambu CPR Printer or USB Interface. Make intubation possible with ET tube, Guedel, Laryngeal Mask and combi-tube. Ambu Man Airway includes torso with hooks for arms, computer interface with CPR software kit (34048 only), track suit jacket, training mat and carrying bag. CPR software kit selectable languages: GB, FR, IT, ES, DE, PT, PL, DK, HU, NL, RU, JP.



34042,  
34048

Size: 80x35 cm  
Weight: 13 kg

### • 34043 COMPLETE SET: ARMS, LEGS, TROUSERS AND BAG

### • 34041 AMBU IV TRAINER

### • 34029 BATTERY PACK



34042,  
34048



## LAERDAL LITTLE FAMILY PACK

### • 56512 LAERDAL LITTLE FAMILY PACK QCPR - 136-01050

Little Family Pack is a convenient package of age-specific CPR training manikins (Little Anne QCPR, Little Junior QCPR and Little Baby QCPR) with a wheeled carrying case for ease of transport and storage. All are provided with QCPR feedback technology to help instructors to improve CPR training quality, efficiency and learner engagement. In compliance with current guidelines, they provide data about the rate and depth of chest compression, complete pressure relaxation, the time of CPR pause and ventilation, through the new QCPR Training Apps, skill guide available via RC cable.

It comes complete with: **Little Anne QCPR Manikin** (manikin, 2 faces, 2 airways), **Little Junior QCPR Manikin** (manikin, 2 faces, 2 airways), **Little Baby QCPR Manikin** (manikin, 6 airways\*), 18 manikin wipes, 3 training mats\* and a large bag on wheels.

\*Included with 56512, not included with 56509

- 56509 LAERDAL LITTLE BABY QCPR MANIKIN - 133-01050
- 56510 LAERDAL LITTLE ANNE QCPR MANIKIN - 123-01050



56512  
3 manikins  
with carrying  
case



Little Baby QCPR

Little Junior QCPR

Little Anne QCPR

## LAERDAL RESUSCI ANNE

### • 56523 LAERDAL RESUSCI ANNE QCPR FULL BODY + TROLLEY - 171-01260

Resusci Anne QCPR is built with realistic anatomy and is fully guideline compliant. It allows multiple feedback options providing opportunity to focus on learner competency: the learner will experience appropriate chest resistance, see chest rise during ventilation and need to perform head tilt, chin lift to ensure an open airway. The QCPR Training and skill report App Android/iPhone technology enables healthcare providers to obtain competence to deliver quality CPR in accordance with the latest guidelines using Bluetooth devices. Supplied with full body with installed 45kg compression spring, two extra compression springs (30kg and 60kg), manikin wipes, 3 face skins in paper bag, 2 airway assembly (standard lung), trolley case, USB 2A AC power adapter, USB cable A-C for the connection with the PC instead of Bluetooth and for battery charging (Li-ion, 2 cells). The connection of the skill guide takes place only via an RC cable connected to the shoulder of the manikin.

User guide (GB, FR, DE, ES, BR, NL, NO, SE, DK, FI, JP, KO, RU, PL).

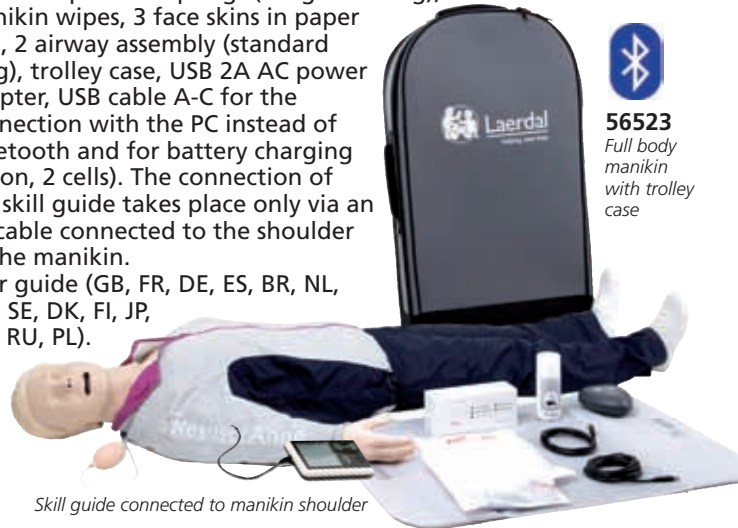

Skill guide connected to manikin shoulder



56523  
Full body  
manikin  
with trolley  
case

## PRACTI-MAN CPR MANIKIN



Multilingual manual:  
GB, FR\*, IT, ES\*, PT\*, DE\*  
for 56500 and 56501  
\*Only on www.gimaitaly.com

Includes: 1 Practi-man,  
5 lungs, 2 valves,  
1 transport bag with mat.

56500

- 56500 PRACTI-MAN ADVANCE CPR MANIKIN
  - 56501 4 PRACTI-MAN ADVANCE CPR MANIKINS
- CPR manikins for massive training events:
- adult and child CPR training with a single manikin
  - 3-position selector dial: adult, child and test
  - real-like system for breathing function
  - jaw thrust maneuver
  - AED training

Jaw thrust  
maneuver

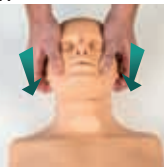

- 56504 PRACTI-MAN LUNGS - box of 5 - spare
- 56505 PRACTI-MAN VALVES - box of 2 - spare



Includes:  
4 Practi-man,  
20 lungs,  
8 valves,  
1 transport bag  
with mat

56501

## CHEST-eR REANIMATION DEVICE

### • 56530 CHEST-eR REANIMATION DEVICE

Chest-eR is a new generation device which assists and improves cardiac massage practice. It can be used by rescuers, hospital staff, common people and educators.

It has been designed to reduce the incidence of internal injuries, providing protection during chest compressions.

A special 3 layer internal structure helps reducing dangerous stresses produced by incorrect application of force, redistributing excessive forces and guaranteeing hygiene. The device includes luminous indicators that inform and show the rescuer on correct pressure and compression rate.

The device perfectly combines with manikins updated according to International Guidelines (i.e. Laerdal Medical, Brayden, .....)

and can be used with defibrillators. Features:

- intuitive and easy-to-use
- compact and lightweight, used with 1.5V battery
- proper resuscitation in complete safety
- ensures maximum effectiveness of cardiac massage
- non-Newtonian materials dissipates impact of too violent compressions absorbing up to 90% of energy

Medical Device Class I. Supplied with 2 protection sheaths and multilingual manual (GB, FR, IT, ES, DE)

### • 56531 PROTECTION SHEATH - box of 30

It guarantees absolute hygiene and prevents risk of infections.

Rigid middle layer allows forces distribution in the lower sternum area

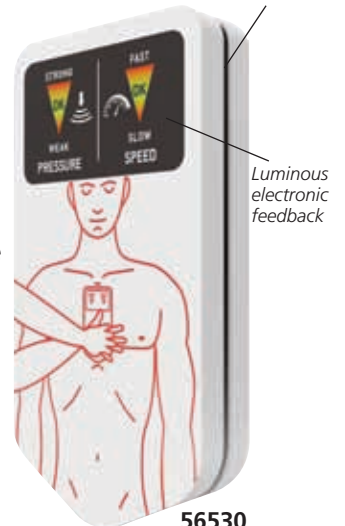

Luminous  
electronic  
feedback

56530

# DTS-3000 SMART PNEUMATIC TOURNIQUET SYSTEM



33138



33138 + 33139



### STANDARD ACCESSORIES

- No pinch single cuff 61x9 cm - red - arm L or thigh S
- No pinch single cuff 80x9 cm - blue - thigh - M
- No pinch single cone cuff 90x12 cm - blue - thigh - L
- No pinch double cuff 57x10 cm - blue - arm - M
- No pinch double cuff 80x15 cm - red - thigh - M
- Air hose                      Power cord                      LOP sensor                      User manual (GB, IT)

### TECHNICAL SPECIFICATIONS

- Max pressure: 800 mmHg
- Voltage: Ac 100-240 V - 50/60 Hz
- Power consumption: 50 W
- Time range: 5-180 min.
- Compressor dimension - weight: 170x210x260 mm - 3 kg

- 33138 DTS-3000 PNEUMATIC TOURNIQUET - 2 channels for 2 double cuffs or 2 single cuffs with 5 no pinch cuffs
- DTS-3000 provides stable operation, easy setup and effective alarm system for safe surgery in an operation room.

### System features

- 2 channels (4 ports for 2 double cuffs or single cuffs)
- easy settings by touch key operation
- graphic LCD screen: easy checking and cleaning
- operation recording (date, time, pressure)
- LOP (Limb Occlusion Pressure) sensor to check limb occlusion pressure and set automatically the optimized pressure
- self test of pressure and system check
- self air pressure sensor calibration
- safety alarm system (cuff, pressure, battery, time)
- built-in battery (max life time: 12-72 hours)

### 5 reusable no pinch cuffs included

- no pinching, no damage to the skin
- lower pressure compared to normal cuff (about 50 mmHg lower)
- no leaking (main reason for lower pressure)

### • 33139 TROLLEY

Standard	No pinch		CUFFS for DTS-2000 and DTS-3000	Size	
	Reusable*	Autoclavable**		Arm	Thigh
-	33141	-	Single cuff 61x9 cm - red	L	S
-	-	33136	Single cuff 61x11 cm - red	L	S
-	33142	-	Single cuff 80x9 cm - blue	-	M
33161	33144	-	Single cone cuff 90x12 cm - blue	-	L
-	-	33137	Single cuff 86x11 cm - red	-	L
-	33145	-	Double cuff 57x10 cm - blue	M	-
-	33146	-	Double cuff 80x15 cm - red	-	M

\*EtCO<sub>2</sub> sterilization

\*\*Silicone rubber bladder



### INTENDED USE OF TOURNIQUET SYSTEM

To be used by qualified medical professionals to temporarily occlude blood flow in patient's extremities during surgical procedures. Tourniquet has been found useful in producing bloodless operation field in surgical procedures involving the extremities including:

- reduction of certain fractures
- Kirschner wire removal
- tumor and cyst excision
- subcutaneous fasciotomy
- nerve injuries
- bone grafts
- total wrist joint replacements
- replacement of joints in the fingers
- knee joint replacements
- amputations
- replantations
- tendon repair

## RIESTER INFUSION CUFFS

- 32684 RIESTER METPAK® INFUSION CUFF - 500 cc - latex free
  - 32685 RIESTER METPAK® INFUSION CUFF - 1,000 cc - latex free
  - 32683 RIESTER METPAK® INFUSION CUFF - 3,000 cc - latex free
- Pressure cuff for infusion with high quality chrome-plated gauge Ø 49 mm up to 300 mmHg.

MADE IN GERMANY



32684

Sturdy blue cotton cuff washable at 60°

## ECONOMIC INFUSION CUFF



32680

- 32680 INFUSION CUFF - 500 cc
- Infusion cuff similar to above. Latex bladder and bulb.

## PNEUMATIC TOURNIQUET

- 33150 RIESTER PNEUMATIC TOURNIQUET with adult arm and thigh cuff - latex free bladder
- 33151 CHILD CUFF 38x8 cm - latex free bladder
- 33148 ADULT CUFF 57x9 cm - latex free bladder - spare
- 33149 THIGH CUFF 96x13 cm - latex free bladder - spare

Reliable pneumatic tourniquet used during amputations to restrict blood circulation in the limbs. A robust and accurate manometer provide exact measurements and a long service life.

- sturdy metal pump to produce pressure
- air in the cuff can escape by opening the release valve
- chromium-plated metal manometer with easy-to-read aluminium scale up to 700 mmHg.
- Supplied with 2 cuffs (upper arm 57x9 cm and thigh 96x13 cm) with latex-free bladders.



33150

MADE IN GERMANY

## VOLUMETRIC INFUSION PUMP

### • 35200 INFUSION PUMP IP-7700

This pump using peristaltic method is a cutting-edge pump realizing high flow precision with compatibility with I.V. set of various brands through ultrasonic bubble detection. IP-7700 provides simple and easy setup process with its numerical silicon keypad. FND and colour LCD provides complete information and user gets the information at one glance. Most infusion condition such as K.V.O. rate, purge rate and bolus can be setup as operating application. Supplied with battery.

#### Main features

- **Light and compact design:** light as 3.5 kg, compact design, and easy to use.
- **Standard compatibility with 4 brands of IV SET:** TERUMO (TS PA 200L), BD (A122), KOREAN VACCINE (1 and 2), ARIES. Each pump can be calibrated for up to 9 different IV set.
- **Flexible flow setting and easy operation method:** Flow-setting range of 1~1000 ml/h, 0,1~999,9 ml/h is available for wide range settings and numerical keypad is easy to use for setting flow-volume.
- **Full program dosage feature (option):** it can calculate the right flow rate for a patient and inject promptly.
- **Easy recognition of alarm:** it notifies errors and emergencies with LED light and buzzer, simultaneous visual and audio alarm system.
- **Notifying remaining battery:** battery LED is attached to notify charged battery showing remaining battery and when to recharge.
- **Keep Vein Open feature:** when reached preset value, it converts to low flow speed of 3ml/h (when IV set is 15, 19, 20 drops/ml) or 1ml/h (when IV set is 60 drops/ml) automatically to prevent flow route clog due to blood coagulation.
- **Ultrasonic air bubble detector**
- **Suitable also for VET use**
- **35202 DROP SENSOR** - for more accurate dropping control (suggested for ICU and new born)
- **35201 Ni-Mh BATTERY** for pump since 2018 SN NE18 - spare
- **35203 Ni-Mh BATTERY** for pump up to 2017 SN NE17 - spare
- **35211 DOSAGE AND PROFILE PROGRAM** need Serial Number
- **26073 I.V. SET ARIES** - box of 150 (6 bags of 25) • **35204 ADAPTER 110 V - 60 Hz** - for 35200

**CALIBRATION TO ANY IV SET BRAND**  
Please send 5 samples of your pump use IV set.  
Delivery in 40 days

Colour LCD

IV clamp included

English and Italian manual

Automatic setup system (flow rate, time, delivery volume)

CE 0120

Numerical silicone key pads



**Flow volume setting range**  
1~1000 ml/h (1 ml infusion interval)  
0.1~999.9 ml/h (0.1 ml infusion interval)  
**Flow volume error margin** ±5%  
**Infusion limit volume range** 1~9999 ml  
**Total estimated volume range** 1~9999 ml  
**K.V.O rate (Keep Vein Open)**  
1 ml/h ~ 10 ml/h adjustable  
**Pump method** Peristaltic method  
**Size (WxDxH)** 100x190x250 mm  
**Weight** 3.5 kg (battery included)  
**Rapid flow volume (Purge)** 1-1000 ml/h adjustable

**TECHNICAL SPECIFICATIONS**  
**Bolus** 1~1000 ml/h adjustable  
**Alarm features**  
Air in line, occlusion, flow error (free flow), door open, K.V.O. (Infusion completion), standby, low battery, alarm, device malfunction (CPU error), empty container (with optional drop sensor)  
**Special features**  
Keypad lock, retain memory, remaining time, alarm repeat, open system, K.V.O., purge, bolus, occ. level, history call-back.  
**Power**  
AC 230V, 50/60Hz and DC9.6V inner source adapter

DC 12 / 24V - 2A Switchable at 110V / 60Hz - with adapter 35204  
**Maximum power consumption** 40VA  
**Electric protection levels**  
Class II B, inner source device, CF type  
**Waterproof level** IPX2  
**Battery type** Ni-Mh rechargeable  
**Battery using time**  
4 hrs (when infusing 125 ml/h)  
**Battery recharging time** Minimum 6 hours.  
**Battery life** approx 6 months

## AUTO SYRINGE PUMP

### • 35205 SYRINGE PUMP SP-8800

Easy syringe installing through one-touch method by slider hook, simple and easy setup process with its numerical silicon keypad. ColourLCD displays infusion information shortcut key manages easy approach for frequent functions. K.V.O. rate, purge rate, bolus and anti bolus can be setup as operating application. Supplied with battery.

#### Flexible flow volume setting.

**Full program dosage feature (optional):** it automatically calculates flow rate by patient's weight, injection's mass and melting.

**Keep Vein Open (K. V. O.) feature:** When reached to the preset value, it converts to low flow speed of 0.1 ml/h automatically to prevent flow route clog due to blood coagulation.

**Standard compatibility with 5 major brands of syringes\*:** Setting feature enables you to choose from following syringe brands: BD (Plastipak, Precise), TERUMO, RAYS, PENTAFERTE, KOVA. Each pump can be calibrated for up to 9 different syringes. Alarm and notification feature: it notifies errors and emergencies with LED light and buzzer.

Simultaneous visual and audio alarm. Occlusion error range setting: you can set the pressure level of occlusion stage to High, Medium and Low by patient's age condition. Suitable also for VET use.

- **35210 Ni-MH BATTERY** - spare
- **35211 DOSAGE AND PROFILE PROGRAM** need Serial Number
- **23873 BD PLASTIPAK SYRINGES 30 ml LL** - box of 60 - BD 301229
- **23874 BD PLASTIPAK SYRINGES 50 ml LL** - box of 60 - BD 300865
- **35204 ADAPTER 110 V - 60 Hz** - for 35205

**CALIBRATION TO ANY SYRINGE BRAND**  
Please send 5 samples of your syringe.  
Delivery in 60 days

IV clamp included

Colour display

CE 0120  
GB, IT manual

Automatic set-up system (flow rate, time, delivery volume)

Easy and quick installation of syringe, just in five seconds



**Flow volume setting range**  
Syringe 10ml: 0.1-300 ml/h  
Syringe 20ml: 0.1-400 ml/h  
Syringe 30ml: 0.1-500 ml/h  
Syringe 50ml: 0.1-1,200 ml/h  
**Flow volume error margin** ±3%  
**Infusion limit volume range**  
0.1~999.9ml (0.1 ml infusion interval)  
**Total estimated volume range**  
0.1~999.9ml (0.1ml infusion interval)  
**K.V.O rate (Vein maintaing function)**  
1-10 ml/h adjustable  
**Size** 220x130x108 mm  
**Weight** 2 kg (battery included)

**TECHNICAL SPECIFICATIONS**  
**Rapid flow volume (Purge)**  
0.1~1200 ml/h adjustable  
**Bolus:** adjustable 0.1~1200 ml/h  
0.1~1000 ml  
**Alarm features**  
Occlusion, K.V.O. (infusion completion), standby, near empty, low battery, device malfunction (CPU error), clamp/handle lever/slider disengaged, syringe disengaged.  
**Special features**  
Keypad lock, shortcut key, retain memory, remaining time, alarm repeat, open system, K.V.O., purge, bolus, anti bolus, occ. level, history call-back.

**Power**  
AC 230V, 50/60Hz and DC9.6V inner source adapter DC 12 / 24V - 2A Switchable at 110V / 60Hz - with adapter 35204  
**Maximum power consumption** 45VA  
**Electric protection levels**  
Class II B, inner source device, CF type  
**Waterproof level** IPX2  
**Battery type** Ni-MH rechargeable  
**Battery using time** 2 hours  
**Battery recharging time** Minimum 6 hrs.  
**Battery life** about 6 months.

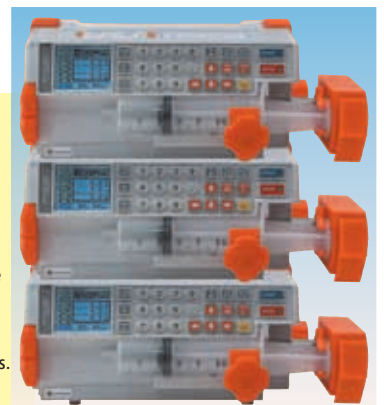

\*Calibration suitable for syringes 10/20/30/50 ml. We can calibrate our pumps for other syringe brands, please provide minimum 5 samples. Availability in 60 days.

## SPENCER 170 AND 190 NXT ELECTRONIC VENTILATORS

- 34006 SPENCER 170 NXT ELECTRONIC VENTILATOR
- 34007 SPENCER 170 NXT KOMPAK ELECTRONIC VENTILATOR
- 34009 SPENCER 190 NXT ELECTRONIC VENTILATOR

Electronic lung ventilators for non invasive ventilation of adult and pediatric patients

- protection against accidental activation of the AIR mix selection lever
- colour coded manometer for easy identification of pressure ranges
- positioning of input and output ports on the side of the device, make connecting and disconnecting easier and offer greater protection to the elements connected to the device
- control knobs on high contrast background for a better identification of the set values
- compact, lightweight aluminium frame

TECHNICAL SPECIFICATIONS	34006-7	34009
Drive:	Electronic	
Frequency:	from 5 to 40 BPM	
Alarms:	High pressure	High pressure
	-	Low pressure
	-	Apnea
Pneumatic supply	Pneumatic supply	Pneumatic supply
Low battery	Low battery	Low battery
Flow:	2 to 20 l/min	
I/E Ratio:	1:2	1:2
Oxygen concentration:	60% or 100% Patented system	
Trigger	from -12 to -2 mbar	
Overpressure valve:	20-60 cm H <sub>2</sub> O - adjustable	
Battery operating time:	Approx. 3 hours	
Manometer scale:	-20 to +80 mbar	
IP protection:	IP24	IP24
Non re-breathing valve:	60 cm H <sub>2</sub> O	
Pneumatic supply:	from 280 to 600 kPa	
Pneumatic connection:	UNI	UNI
External source:	12 V DC	
Internal source:	on request AC/DC adapter 100-240 V, 50/60 Hz	
Dimensions (mm):	270x177x210	330x177x210
Weight:	3.5 kg	3.6 kg
Structure:	Aluminium, steel, brass, PE	

### STANDARD ACCESSORIES

- Patient circuit (corrugated tubing with non re-breathing valve)
- Power cable
- Oxygen tube
- Manual: GB, IT, on request FR, ES, DE, PT
- 2 l oxygen cylinder, pressure reducer, transport case (34007 only)
- Adult face-mask
- Battery
- UNI adaptor



34007

- place and shape of adjustment knobs make the setting of parameters easier in all operative conditions
- constant I/E ratio
- alarms for ventilation monitoring and device management

### Ventilator 190 NXT also features:

- led bar for breath monitoring
- three ventilation modes (only one for 34006-7)  
CMV: mandatory inflation is initiated according to the set parameters  
TVM: inflation initiated according to the set parameters only if triggered by the patient  
A/CV: inflation is assured to be initiated at intervals determined by the set rate, unless initiated by an earlier patient trigger event.

### Kompak ventilator with transport case.

Transport case containing ventilator 170 NXT, oxygen cylinder with pressure regulator ready to use.

- 34035 CORRUGATED PVC TUBE - 117 cm
- 34036 PATIENT CIRCUIT (valve+corrugated tube)
- 34019 BATTERY - spare for 34006, 34007, 34009

MADE IN ITALY



34006



34009

## SPENCER 118 NXT PNEUMATIC LUNG VENTILATOR

- 34016 SPENCER 118 NXT AUTOMATIC VENTILATOR
- 34017 SPENCER 118 NXT KOMPAK AUTOMATIC VENTILATOR

Pneumatic lung ventilator for non-invasive ventilation of adult and pediatric patients. The pneumatic mode of operation allows a significant reduction of maintenance costs associated with the requirements of electrical safety regulations. Total absence of electrical shock risks generated by the device. Protections against accidental activation of power and AIR MIX levers. Colour coded manovacuometer for an immediate display of the pressure in the patient circuit. Lateral positioning of the medical gas input and output, makes the connection and disconnection easier and offers greater protection for the elements connected to the device. Adjustment knobs on high-contrast background allows a better identification of settings. Small, lightweight aluminium body. Positioning and shape of the adjustment knobs facilitate the setting of the ventilation parameters in all operating conditions. The non-constant I/E ratio makes the management of the ventilation more versatile. The presence of one ventilation mode makes it simple and easy to operate. Equipped with alarms required by the EN 794-3 standard.

Class IIb Med. Device according to Dir. 93/42/CEE.

### Kompak ventilator with transport case.

Transport case containing ventilator, oxygen cylinder with pressure regulator ready to use.

- 34035 CORRUGATED PVC TUBE - 117 cm
- 34036 PATIENT CIRCUIT (valve+corrugated tube)



34016

### TECHNICAL SPECIFICATIONS

Drive	100% pneumatic
Ventilation mode	Controlled (VC - CMV)
Respiration frequency	10 to 70 breaths/min.
Inspiratory-expiratory phase time I:E	1:2.0 ±0.3 at 10 bpm - 1:1.5 ±0.3 at 70 bpm
Frequency:	10 to 70 bpm
Flow	2 to 20 l/min adjustable
Oxygen concentration	From 60 or 100%
Safety valve	From 20 to 60 mbar
Monovacuometer precision:	1.6
Manovacuometer scale	-20 to +80 mbar
High pressure alarm	60 ±5 mbar
Non-rebreathing valve	Autoclavable, 60 cm H <sub>2</sub> O
Input connection	UNI
Input pressure	280 to 600 kPa
Dimensions - weight	270x210x177 mm - 3.8 kg
Structure	aluminium, steel, brass, PE

### STANDARD ACCESSORIES

- Patient circuit (corrugated tubing with non re-breathing valve)
- Oxygen tube 100 cm - UNI adaptor
- Pressure reducer (34017 only)
- Adult face-mask
- 2 l oxygen cylinder (34017 only)
- Transport case (34017 only)
- Antibacterial filter
- Guedel cannula, tongue holder (34017 only)
- Manual: GB, IT, on request FR, ES, DE, PT

## RESPIRA OXYGEN CONCENTRATOR 5 LITRES

### • 34582 RESPIRA OXYGEN CONCENTRATOR 5 I

Small and portable oxygen concentrator composed of air compressor, absorption tower of molecular sieve, sensor and flowrate controller. The machine adopts PSA (pressure swing absorbers) method to directly concentrate medical oxygen with high concentrator from the air. Lightweight, easy to use and safe. Stable performance and low noise level. Wide application in clinic, hospital, oxygen bar, gym center...

Supplied with humidifier bottle, power cord, nasal cannula and user manual (GB, FR\*, IT, ES\*, DE\*) \*only on www.gimaitaly.com

Size: 508x260x h 530 mm. Weight: 21 kg

- 34583 PAPER FILTER - box of 10
- 34584 HUMIDIFIER BOTTLE - 1 I
- 34166 OXYGEN MASK with tube - adult
- 34167 OXYGEN MASK with tube - pediatric
- 34172 OXY GLASSES - nasal cannulas

#### TECHNICAL SPECIFICATIONS

Max. flowrate:	5l/min
Flow range:	0.5-5l/min
Oxygen concentration:	93% ±3%
Output pressure:	20kPa-50kPa
Input power:	450VA
Noise level:	≤55dB(A)
Operating voltage:	AC220V ± 10%, 50Hz ±1 Hz
Type of protection:	Class II, Type BF, IP21

Oxygen concentrator control panel



## SMART OXYGEN CONCENTRATORS 3 AND 5 LITRES

### • 34603 SMART OXYGEN CONCENTRATOR 3 I

### • 34598 SMART OXYGEN CONCENTRATOR 5 I

Medical grade, ultra quiet, small oxygen concentrators for home use. Provide high concentration of oxygen through nasal cannula. Work continuously. Supplied with filter and humidifier bottle. Class II, Type BF

- 34599 PAPER FILTER - box of 10
- 34608 HUMIDIFIER BOTTLE - spare
- 34167 OXYGEN MASK with tube - pediatric
- 34166 OXYGEN MASK with tube - adult
- 34172 OXY GLASSES - nasal cannulas

**yuwell**  
Top manufacturer  
over 200,000 pcs/years

#### TECHNICAL SPECIFICATIONS

	34603	34598
Flow range:	0.5 ~ 3 l/min	0.5 ~ 5 l/min
Oxygen concentration:	93% ± 3%	95.5 - 87 %
Output pressure:	20 ~ 50 kPa	40 ~ 70 kPa
Input power:	230 W	350 W
Noise level (front - whole unit):	42 - 46 dBA	≤48 - ≤52 dBA
Size - weight:	39x24.5xh 50 cm - 11.8 kg	39x24xh 50 cm - 16 kg
Operating voltage:	230 V - 50 Hz	(110 V - 60 Hz on request)
Minimum operating time*:	30 min	

\*Time necessary to reach optimal oxygen concentration



## OXYGEN CONCENTRATOR 5 LITRES

### • 34605 OXYGEN CONCENTRATOR 5 I

Bionic and streamlined fashion design, which won the national outlook top award-Red Star Award.

Low noise achieved by using advanced round airway and multi-level noise decreasing design.

Large LCD screen for clearer figures.

Cumulative time metering and timing off function.

Fault self-detection system.

Four alarm functions:

- power failure alarm
- pressure cycle failure alarm
- low oxygen concentration alarm
- compressor failure alarm

Supplied with filter, nasal oxygen cannula, nebulizer set and manual (GB, IT)

### • 34607 PAPER FILTER - box of 10

(5 internal + 5 external)

- 34619 HUMIDIFIER BOTTLE
- 34166 OXYGEN MASK with tube - adult
- 34167 OXYGEN MASK with tube - pediatric
- 34172 OXY GLASSES - nasal cannulas

**yuwell**  
Top manufacturer  
over 200,000 pcs/years

CE 0123

#### TECHNICAL SPECIFICATIONS

Flow range:	0.5 - 5 l/min
Oxygen concentration:	95.5% ~ 87%
Output pressure:	40 ~ 70 kPa
Operation noise level:	≤ 53 dB (A)
Input power:	400 VA
Net/gross weight:	25/27 kg
Size:	28.5x54.5xh71.2 cm
Packing size:	62x37xh 71 cm
Operating voltage:	230 V - 50 Hz (on request 110 V - 60 Hz)



## OXYGEN CYLINDERS: 0.5, 2, 3, 5 AND 7 LITRES



**CYLINDERS FOR OXYGEN THERAPY (empty)**  
Steel cylinders for therapeutic oxygen at 200 bar pressure, with valve and safety lock. Suitable for home and hospital therapeutic use, especially in case of desultory oxygen supply. Supplied in a sturdy plastic bag (5 and 7 l) or soft bag (2 and 3 l) with cover. Oxygen cylinders are provided with a pressure reducer with two-stage release valve (0-15 l/min) and high pressure manometer to indicate oxygen quantity in the cylinder (Code 34510/34511) and face mask (excluding 34501/34521).

GIMA code		OXYGEN CYLINDERS WITH INTEGRATED PRESSURE REDUCER				
UNI	NF	Litres	Flow	Size	Weight kg	
34501**	34521**	0.5	fixed 6 l	Ø 60x400mm	2.75	-
34502	34522*	2	0/15 l	Ø110x410mm	4.5	with soft bag + cover
34503	34523*	3	0/15 l	Ø110x530mm	5.5	with soft bag + cover
34505	34525*	5	0/15 l	Ø140x550mm	9	with plastic bag + cover
34507	34527*	7	0/15 l	Ø140x680mm	11	with plastic bag + cover

\*Products not in stock, available in 15 days

\*\*Aluminium oxygen cylinder with pressure reducer to be assembled (not integrated)

### PRESSURE REDUCER WITH VALVE

Pressure reducer with valve and index flowmeter adjustable 0-12 l/min, suitable for cylinders 1 to 3 litres (code 34510/34530) and 5 to 7 litres (34511/34531). It includes two stages, release valve and high pressure manometer. Thread cylinder connection: E25/E17 conical refill thread connection

UNI 21.7 x 1/14" or NF Ø 22.91 x 1.514

Apparatus to be connected to a cylinder without valve.

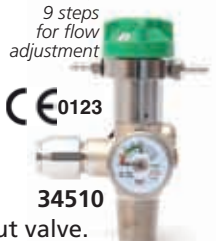

Oxygen therapy masks are produced with non toxic material, complete with adjustable elastic clip for nose and connecting tube



GIMA code		PRESSURE REDUCERS WITH VALVE - spare	
UNI	NF		
34510	34530*	Integrated pressure reducer with valve for 2/3 litres	
34511	34531*	Integrated pressure reducer with valve for 5/7 litres	
34539		Cover protection for cylinders 2/3/5/7 litres	

\*Products not in stock, available in 15 days

GIMA code		OXYGEN THERAPY MASKS	
34166		Oxygen therapy mask - adult - with tube	
34167		Oxygen therapy mask - paediatric - with tube	
34168		HI-Oxygen therapy mask - adult - with tube	
34169		HI-Oxygen therapy mask - paediatric - with tube	
34276		Disposable oxy tube - 2m - female - female	
34172		Oxy glasses - nasal cannulas	

## GENERAL PURPOSE CYLINDERS 5 AND 10 l AND PRESSURE REDUCERS



### GENERAL PURPOSE CYLINDERS (empty)

Supplied with valve. Ideal for anaesthesia apparatus, can be used with pressure reducer code 34540-34541 or other standards (NF, DIN, BRITISH STD or PIN INDEX).

GIMA code					OXYGEN CYLINDER WITH VALVE AND ACCESSORIES
UNI	NF	DIN	BULLNOSE BRITISH STD	PIN INDEX	
34545	34555*	34565*	34575*	34585*	Oxygen Cylinder 5 l with valve
34548	34558*	34568*	34578*	34588*	Oxygen Cylinder 10 l with valve
34540	34550*	34560*	34570*	34580*	Pressure reducer
34541	34551*	34561*	34571*	34581*	Pressure reducer with flowmeter and humidifier
34590	34590	34590	34590	34590	Humidifier autoclavable at 121°C

\*Products not in stock, available in 15 days

### PRESSURE REDUCER (34540, 34550, 34560, 34570, 34580)

Same as code 34541, with adjustable flow 0-15 l/m in 9 steps (1/1.5/2/3/4/6/9/12/15), LP\* port, without flowmeter and humidifier.

\*Low pressure port (for ventilators,...)

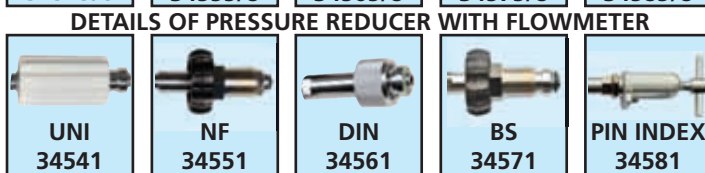
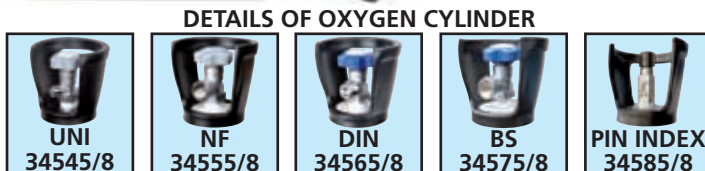

### PRESSURE REDUCER - WITH FLOWMETER AND HUMIDIFIER (34541, 34551, 34561, 34571, 34581)

Pressure reducer with release valve and H.P. manometer with adjustable ball flowmeter 0-15 l/min and autoclavable humidifier apparatus to be connected with cylinder valve.



- 34590 AUTOCLAVABLE HUMIDIFIER\*\* 0,25 l
- 34591 DISPOSABLE HUMIDIFIER\*\* 0,4 l - box of 50
- 34177 TROLLEY FOR OXYGEN CYLINDER - 5 l - 7 l
- 34178 TROLLEY FOR OXYGEN CYLINDER - 10 l

\*\*Screw connection to flowmeter: 9/16 inch

# SILICONE AUTOCLAVABLE AND SINGLE USE FACEMASKS

**GIMA AUTOCLAVABLE FACE MASKS**  
Made of silicone and polycarbonate (sizes 3, 4, and 5) or all in silicone (sizes 0, 1 and 2). Completely transparent, allowing a total visibility. They can be used with any resuscitator and lung ventilator.

**GIMA PLUS AUTOCLAVABLE FACE MASKS - ANAESTHESIA MASKS**  
Blue silicone inflating cuff and unbreakable transparent polysulfone hood. They can be used with any resuscitator or lung ventilator. Available in 5 sizes. Latex free.

**INFLATABLE AIR CUSHION FACE MASKS - ANAESTHESIA MASKS** 57706  
Single patient face masks with connector for air inflation and hook. Available in 7 sizes.

**AUTOCLAVABLE UP TO 40 TIMES**



**AUTOCLAVABLE UP TO 120 TIMES**



**CE 0434 SINGLE PATIENT**



GIMA code	SILICONE FACE MASKS LATEX FREE
34220	Facemask N° 0 - infant small
34221	Facemask N° 1 - infant large
34222	Facemask N° 2 - child small
34223	Facemask N° 3 - child large
34224	Facemask N° 4 - adults small
34225	Facemask N° 5 - adults large

GIMA code	GIMA PLUS FACE MASKS LATEX FREE
34252	Face mask N°2 - child small
34253	Face mask N°3 - child large
34254	Face mask N°4 - adult small
34255	Face mask N°5 - adult large
34250	Face mask N°6 - adult extra large

Multilingual manual: GB, FR, IT, ES, DE.

GIMA code	GIMA SINGLE PATIENT FACE MASKS LATEX FREE
57700	Facemask N° 0 - newborn - white
57701	Facemask N° 1 - infant - pink
57702	Facemask N° 2 - child - yellow
57703	Facemask N° 3 - child large - red
57704	Facemask N° 4 - adult - green
57705	Facemask N° 5 - adult large - blue
57706	Facemask N° 6 - adult extra large

# OXYGEN RESERVOIRS, VALVES AND ACCESSORIES

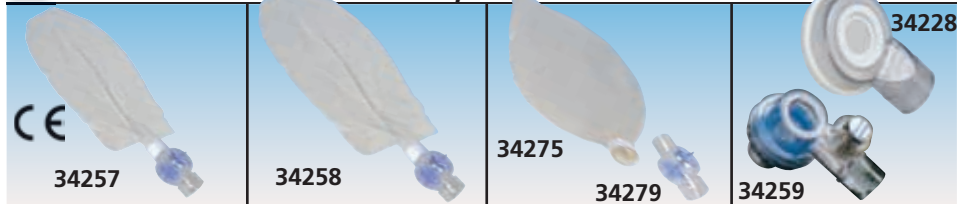

GIMA code	OXYGEN RESERVOIR - OXYGEN TUBE	To be used with GIMA codes
34275	SINGLE USE OXYGEN RESERVOIR - 2,500 ml - without valve	34244 - 34245 - 34277 - 34200 (need valve 34279), AMBU, LAERDAL 34275
34279	RESERVOIR VALVE - autoclavable	34246 - 34247 - 34248 - 34249
34257	SINGLE USE OXYGEN RESERVOIR - 1,000 ml - with valve	34244 - 34245 - 34277
34258	SINGLE USE OXYGEN RESERVOIR - 2,500 ml - with valve	All resuscitators
34276	OXYGEN TUBE - 2 m	34244 - 34245 - 34277
34259	NON-REBREATHING VALVE with 60 cm H <sub>2</sub> O Pop-off - autoclav.	34244-5 - 34277 (need 34228)
34227	PEEP VALVE - 30 mm (5-20 cm H <sub>2</sub> O) autoclavable at 121°C/248°F	34230 - 34240 - 34200
34228	PEEP VALVE ADAPTOR - int. Ø 22 mm, ext. Ø 30 mm	34227 - 34248 - 34249
34256	REAR VALVE (intake valve)	34244 - 34245 - 34246 - 34247

# ULTRA FACE MASKS

**ULTRA ANAESTHESIA - FACE MASKS**  
Disposable single patient face masks. Anti-slip design and anatomical shape for a precise fit. Excellent visibility, soft and comfortable seal. Provided with hook. Medical grade non-PVC, phthalate free.



GIMA code	ULTRA SINGLE PATIENT FACE MASKS LATEX FREE - box of 50	Suitable for kg
57711	Facemask N° 1 - infant - pink	2-10
57712	Facemask N° 2 - child - yellow	10-25
57713	Facemask N° 3 - adult S - green	25-60
57714	Facemask N° 4 - adult M - red	60-110
57715	Facemask N° 5 - adult L - blue	>110

# MOUTH OPENERS AND TONGUE HOLDING



- 34272 HELICOIDAL MOUTH OPENER PINOCCHIO
- 34273 TEETH SCREW DRIVER
- 34274 TONGUE HOLDING FORCEPS

# NYLON BAG

• 34271 NYLON BAG  
Suitable for all resuscitators.  
Size: 18.5x15x30 cm

# VENTURI VARIABLE CONCENTRATION MASK FOR OXYGEN THERAPY



- 34170 VENTURI TYPE VARIABLE CONCENTRATION MASK - adult - box of 50
- 34171 VENTURI TYPE VARIABLE CONCENTRATION MASK - pediatric - box of 50

Disposable adult or pediatric mask with Venturi system, with corrugated tubing 15 cm, extension tubing 200 cm, cup and seven adapters for variable oxygen concentration. Latex free.

% Regulators	Litres/minute to reach desired oxygen concentration	Colour coded according to EN 13544-3:2001
24%	2	Blue
28%	4	White
31%	6	Orange
35%	8	Yellow
40%	8	Red
50%	12	Fuchsia Pink
60%	15	Green

## AMBU® MARK IV RESUSCITATORS

34200

34215



0301 Boys - 2  
Prematures - 0A

Adults - 5  
Children - 0

Adults  
large - 6

Adults  
small - 4



34204



• **34200 AMBU® MARK IV RESUSCITATOR - adult**  
Designed in accordance with the original double wall principle, the new 100% latex-free Ambu bags are more robust and provide users with exceptional visual and tactile lung condition feedback during manual resuscitation, making operation safer and more secure. Built-in pressure limitation prevents compression if there is any resistance in the patient's airways. Suitable for adults and children over 15 kg (3 years). Supplied with face mask N°5 and single shutter valve. Autoclavable at 134°C. Maximum volume 1300 ml.

• **34204 AMBU® MARK IV RESUSCITATOR - baby**  
Same as 34200, but suitable for neonates, infants and children up to 20 kg (approx 4-5 years). Supplied with face mask N°0A, oxygen reservoir tube 250 mm and pressure limiting valve 4.0 kPa (40 cm H<sub>2</sub>O). Maximum volume 300 ml.

• **34217 AMBU MARK® IV RESUSCITATOR - adult with kit bag**  
Same as code 34200, supplied with helicoidal mouth-wedge, tongue holding forceps, 3 Guedel airways (small, medium and large) and oxygen tube, all fitted in a resistant nylon bag.

### TRANSPARENT

### SILICONE AMBU FACE MASKS - Latex-free

The silicone face masks are self-inflating and the cuff pressure can be regulated for an easy and efficient seal. They are comfortable to grip and feature a thumb rest so rescuers can achieve a tight seal. Visual checks of bleeding, vomitus and spontaneous breathing can be made through the transparent dome. Autoclavable at 134°C

GIMA code	AMBU TRANSPARENT LATEX-FREE FACE MASKS AND RESERVOIR
34210	Ambu Baby N° 0A - newborns/prematures - blue
34205	Ambu Baby N° 0 - newborns/children - blue
34206	Ambu N° 2 - boys - blue
34207	Ambu N° 3/4 - adults/small - blue
34208	Ambu N° 5 - adults - blue
34209	Ambu N° 6 - adults/large - blue
34215	Reservoir bag 1500 ml - adult

34215



34217

## SILICONE TRANSPARENT AUTOCLAVABLE RESUSCITATORS

### SILICONE RESUSCITATORS - latex free

Transparent resuscitators made of silicone and polysulfone fully autoclavable at 134°C.

• **34244 SILICONE RESUSCITATOR KIT - adult**  
Supplied with silicone face mask N° 4, 60 cm H<sub>2</sub>O pop-off valve, oxygen tube 2 metres, autoclavable reservoir valve and 2500 ml reservoir bag. Volume: 1,600 ml.

• **34245 SILICONE RESUSCITATOR - adult**  
Supplied with silicone face mask N° 4. Volume: 1600 ml.

• **34246 SILICONE RESUSCITATOR - child**  
Supplied with silicone face mask N° 3 and 40 cm H<sub>2</sub>O pop-off valve. Volume: 500 ml.

• **34247 SILICONE RESUSCITATOR - infant**  
Supplied with silicone face mask N° 1 and 40 cm H<sub>2</sub>O pop-off valve. Volume: 280 ml.

All silicone resuscitator have multilingual manual: GB, FR, IT, ES, PT

• **34243 SILICONE RESUSCITATOR BAG KIT - adult**  
Supplied with silicone face mask N° 4, 60 cm H<sub>2</sub>O pop-off valve, oxygen tube 2 metres, autoclavable reservoir valve and 2,500 ml reservoir bag (volume: 1,600 ml), helicoidal mouth wedge (34273), tongue holding forceps, 10 Guedel airways (34439) with Cubo emergency bag (27163).



0476  
All resuscitators  
are LATEX FREE

34245



34243

Intake valve



34244



34246



34247



## AMBU® SPUR II RESUSCITATOR - THE NEXT GENERATION

### AMBU SPUR II RESUSCITATOR - single patient

Ambu SPUR II provides users with exceptional tactile and visual feedback during resuscitation. The bag is highly responsive, with minimal mechanical resistance. Furthermore the characteristic design provides optimum stroke volume with perfect recoil. Range includes infant, pediatric, and adult sizes. All Ambu SPUR II resuscitators come in individual, resealable plastic carrying bags, complete with mask, reservoir bag (34235, 34236 only) oxygen tube and pressure limiting valve 4.0 kPa H<sub>2</sub>O (34236/7 only). The bags are color-coded for fast identification of infant, pediatric, and adult sizes.

- 34235 AMBU SPUR II ADULT - with face mask n° 5 and reservoir bag
- 34236 AMBU SPUR II PEDIATRIC - with face mask n°1 and reservoir bag
- 34237 AMBU SPUR II INFANT - with face mask n° 0

	TECHNICAL SPECIFICATIONS		
	34235	34236	34237
Suitable for	adult > 30 kg	baby 10 to 30 kg	infant < 10 kg
Stroke volume	1 hand	800 ml	450 ml
	2 hand	1,000 ml	150 ml
Resuscitator volume	1,475 ml	635 ml	220 ml
Size (Length x diameter)	295x127 mm	234x99 mm	168x71 mm
Bag reservoir volume	2600 ml	1500 ml	-

Thin-walled compression bag allows for lung compliance and "feel"

Integrated handle for user comfort and uniform compression

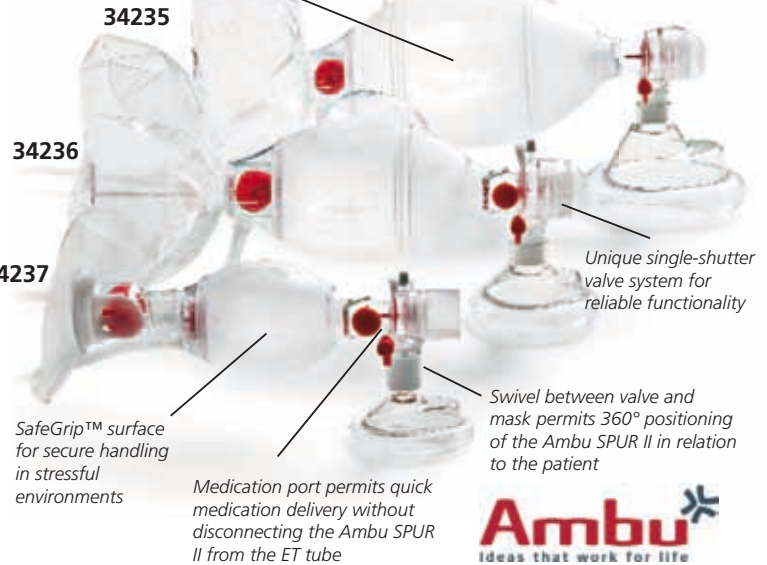

SafeGrip™ surface for secure handling in stressful environments

Medication port permits quick medication delivery without disconnecting the Ambu SPUR II from the ET tube



## RESUSCITATOR BAGS SINGLE-USE, SINGLE PATIENT - LATEX FREE

### PVC RESUSCITATORS - SINGLE PATIENT USE

Disposable resuscitator bags with disposable mask, no return membrane valve and connection for PEEP valve. PVC disposable, transparent mask shaped to allow a perfect adhesion to the patient's face. Latex free.

- 34277 PVC RESUSCITATOR - adult  
Supplied with single use mask N° 5. Volume: 1,600 ml



Manual: GB, FR, IT, ES.

- 34248 PVC RESUSCITATOR - child  
Supplied with single use mask N° 3 and 40 cm H<sub>2</sub>O pop-off valve. Volume: 500 ml

- 34249 PVC RESUSCITATOR - infant  
Supplied with single use mask N° 1 and 40 cm H<sub>2</sub>O Pop-off valve - Volume: 280 ml

- 34239 PVC RESUSCITATOR KIT - adult  
Same as code 34277. Supplied with oxygen reservoir 2,500 ml, valve tongue holding forceps and oxygen tube in a nylon bag.



## GUEDEL AIRWAYS

### STERILE AND NON STERILE GUEDEL AIRWAYS

Guedel airways in 9 sizes with smooth surface and round tip for improved patient comfort.

Made of polyethylene (PE). Latex free. Multilingual instructions: GB, FR, IT, ES.

GIMA code	GUEDEL AIRWAYS - STERILE FLEXIBLE, TRANSPARENT, INDIVIDUALLY PACKED GUEDEL AIRWAYS	Minimum order
34431●	Guedel airway 40 mm - pink - newborn - 000	box of 10
34432●	Guedel airway 50 mm - blue - newborn - 00	box of 10
34433●	Guedel airway 60 mm - black - child - 0	box of 10
34434▲	Guedel airway 70 mm - white - boy - 1	box of 10
34435▲	Guedel airway 80 mm - green - adult/small - 2	box of 10
34436●	Guedel airway 90 mm - yellow - adult/small - 3	box of 10
34437●	Guedel airway 100 mm - red - adult/medium - 4	box of 10
34438●	Guedel airway 110 mm - orange - adult/large - 5	box of 10
34383	Guedel airway 120 mm - purple - adult/x-large - 6	box of 10
34439	Mixed Guedel airways pack of 1 pcs. of ● marked and 2 pcs of ▲ marked airways for a total of 10 pcs.	



GIMA code	GUEDEL AIRWAYS - NON STERILE FLEXIBLE, TRANSPARENT,	Minimum order
57751	Guedel airway 40 mm - pink - newborn - 000	box of 50
57752	Guedel airway 50 mm - blue - newborn - 00	box of 50
57753	Guedel airway 60 mm - black - child - 0	box of 50
57754	Guedel airway 70 mm - white - boy - 1	box of 50
57755	Guedel airway 80 mm - green - adult/small - 2	box of 50
57756	Guedel airway 90 mm - yellow - adult/small - 3	box of 50
57757	Guedel airway 100 mm - red - adult/medium - 4	box of 50
57758	Guedel airway 110 mm - orange - adult/large - 5	box of 50

# AMBU® DISPOSABLE LARYNGEAL MASKS - STERILE

## AMBU® AURAONCE™ DISPOSABLE LARYNGEAL MASKS

AuraOnce has a special curve that carefully replicates natural human anatomy. Molded directly into the tube, the unique shape makes correct insertion easy without abrading the upper airway. AuraOnce's curve also ensures that the patient's head remains in a natural supine position when the mask is in use without extra stress on the upper jaw. Moreover, Auraonce is specially designed to give the airway tube the flexibility needed to adapt to individual anatomical variances and wide range of head positions. AuraOnce has a D-shaped airway tube to give a firm and ergonomical grip during insertion. In short, positioning is fast and accurate, with least possible internal pressure.

GIMA code	AMBU® AURAONCE™	Patient weight	Maximum cuff inflation volume
34406	Laryngeal Mask N 2 - pink	10-20 kg	10 ml
34407	Laryngeal Mask N 2.5 - pink	20-30 kg	14 ml
34408	Laryngeal Mask N 3 - green	30-50 kg	20 ml
34409	Laryngeal Mask N 4 - yellow	50-70kg	30 ml
34410	Laryngeal Mask N 5 - blue	70-100 kg	40 ml

### AMBU® AURAONCE™ VENTILATION

Cuff and airway tube moulded as single unit with built-in, anatomically correct curve

The airway tube is flexible at the cuff and rigid at the connector for easy, atraumatic insertion and removal

Practical clear "window" to view condensation

Smooth sides without ridges or fins that can scratch delicate tissue

Ultra thin pilot balloon with universal check valve provides precise tactile indication of degree of inflation

Universal 15 mm connector (ISO)

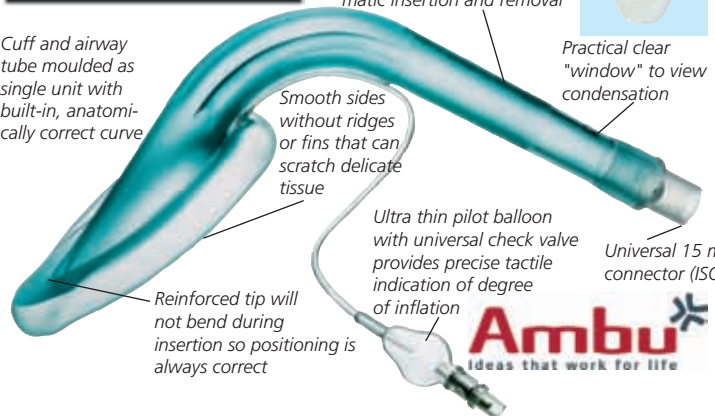

## AMBU® AURA-i™ DISPOSABLE LARYNGEAL MASKS

The soft rounded curve of the Aura-i pre-formed to follow the anatomy of the human airway, ensures fast and easy placement and guarantees long-term performance. Aura-i is the preferred everyday routine device for establishing an airway where an ET-tube is deemed unnecessary. At the same time it holds a place on the difficult airway cart. In case of a "Cannot Intubate - Cannot mask Ventilate" (CI-CV) situation, where the purpose is to intubate the patient, Aura-i can be used as conduit for direct endotracheal intubation assisted by a flexible scope. The airway tube is designed to allow easy passage of an appropriately sized ET-tube. The recommended ET-tube size is indicated on the connector block of the mask.

GIMA code	AMBU® AURA-i™	Patient weight	Max. cuff inflation vol.	Max mask ET-Tubes*
34593	Laryngeal Mask N 2 - pink	10-20 kg	10 ml	5.0
34594	Laryngeal Mask N 2.5 - violet	20-30 kg	14 ml	5.5
34595	Laryngeal Mask N 3 - green	30-50 kg	20 ml	6.5
34596	Laryngeal Mask N 4 - orange	50-70kg	30 ml	7.5
34597	Laryngeal Mask N 5 - blue	70-100 kg	40 ml	8.0

### AMBU® AURA-i™ VENTILATION & INTUBATION

Built-in, anatomically correct curve for fast and easy insertion

Navigation marks to guide flexible scope

Intubation capability using standard ET-tubes

Universal 15 mm connector (ISO)

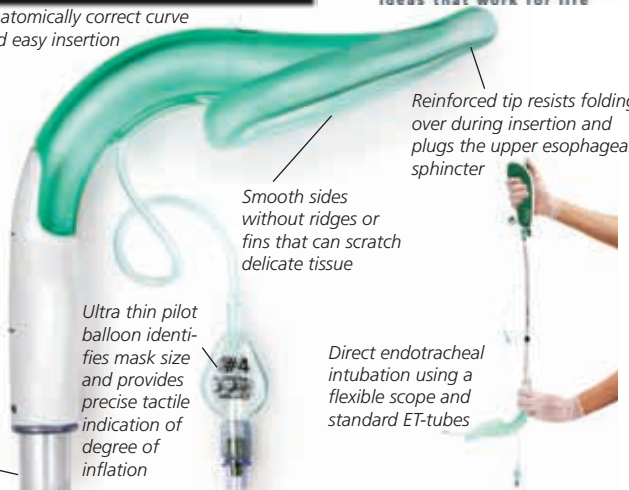

## AMBU® AURAGAIN™ DISPOSABLE LARYNGEAL MASKS

The AuraGain satisfies 3 fundamental airway management needs by integrating gastric access and intubation capability in an anatomically curved single-use device that facilitates rapid establishment of a safe airway.

### Rapid placement

The soft rounded curve of the AuraGain, pre-formed to follow the anatomy of the human airway, ensures rapid placement and guarantees long-term performance. The thin and soft cuff of the AuraGain is designed to deliver high seal pressures.

### Gastric control

The integrated gastric access channel is designed with a low friction inner surface to facilitate easy placement of a gastric tube, to enable active and passive management of gastric content and prevent gastric insufflation.

### Integrated intubation capability

It provides the added safety feature of intubation capability. This means that in case of an unexpected difficult airway, or a "Cannot Intubate - Cannot mask Ventilate" (CI-CV) situation, where the endgame is to intubate the patient, AuraGain can be used as conduit for direct endotracheal intubation assisted by a flexible scope.

### All-round versatility

Rapid placement, high seal pressure, gastric access and intubation capability make the AuraGain the obvious and safe choice for every procedure where a laryngeal mask is indicated.

GIMA code	AMBU® AURAGAIN™	Patient weight	Max mask ET-Tubes*	Gastric-Tube max (FR)	Max cuff inflation vol
57600	Laryngeal Mask N 1**	<5 kg	3.5	6 FR	4 ml
57601	Laryngeal Mask N 1.5**	5-10 kg	4.0	8 FR	7 ml
57602	Laryngeal Mask N 2	10-20 kg	5.0	10 FR	10 ml
57603	Laryngeal Mask N 2.5	20-30 kg	5.5	10 FR	14 ml
57604	Laryngeal Mask N 3	30-50 kg	6.5	16 FR	20 ml
57605	Laryngeal Mask N 4	50-70 kg	7.5	16 FR	30 ml
57606	Laryngeal Mask N 5	70-100 kg	8.0	16 FR	40 ml
57607	Laryngeal Mask N 6	>100 kg	8.0	16 FR	50 ml

### AMBU® AURAGAIN™ VENTILATION, INTUBATION, GASTRIC ACCESS



Soft bite absorption area with helpful markings and accessory size information

Navigation marks for guiding flexible endoscopes

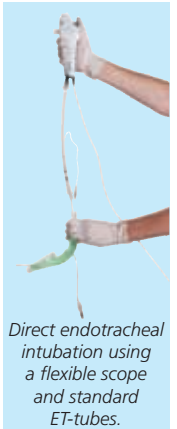

Direct endotracheal intubation using a flexible scope and standard ET-tubes.

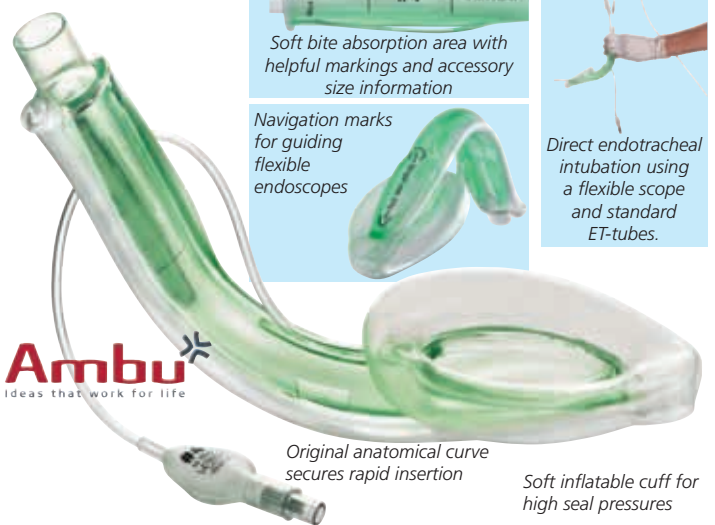

### TECHNICAL SPECIFICATIONS AURAONCE™, AURA-i™, AURAGAIN™

Maximum intra-cuff pressure:	60 cm H <sub>2</sub> O
Airway connector:	15 mm ISO 5356-1
Tube/cuff material:	PVC (latex and phthalates free)
Complete range for neonatal (AuraGain only), pediatric and adult patients	
Packaged sterile and ready for use	
Colour coded pouch with directions for use.	

# LARYNGEAL MASKS FOR SAFE AND EASY INTUBATION

## SILICONE REUSABLE LARYNGEAL AIRWAY MASK

- Optimal anatomical design ensure convenient and safe insertion. Universal 15 mm connector (ISO).
- See-through flexible airway tube, clear guideline for easy insertion.
- Tiny protruding bumps minimize the vomiting substance flowing from exophagus and into the lung.
- Seamless cuff formation offers maximum comfort.
- Strengthened oval tip prevents possible bending during insertion.
- Thin walled pilot balloon facilitates the sensing of the inflation tube.



Each laryngeal airway mask is individually serialized for identification and traceability purposes

GIMA code	Size	Patient range	Weight range	Cuff volume (ml. of air)
34424	1.5	infant	5-10 kg	7 ml
34425	2	infant	10-20 kg	10 ml
34426	2.5	child	20-30 kg	14 ml
34427	3	boy	30-50 kg	20 ml
34428	4	adult	50-70 kg	30 ml
34429	5	adult	>70 kg	40 ml



# STERILE CUFFED AND UNCUFFED ENDOTRACHEAL TUBES

GIMA code	UNCUFFED ENDOTRACHEAL TUBES - STERILE	Minimum order
34385	Uncuffed Endotracheal tube Ø 3 mm - 16.5 cm	box of 10
34386	Uncuffed Endotracheal tube Ø 4 mm - 21 cm	box of 10

GIMA code	CUFFED ENDOTRACHEAL TUBES - STERILE	Minimum order
34387	Cuffed Endotracheal tube Ø 3.5 mm - 18.5 cm	box of 10
34388	Cuffed Endotracheal tube Ø 5 mm - 24.5 cm	box of 10
34389	Cuffed Endotracheal tube Ø 6 mm - 28.5 cm	box of 10
34390	Cuffed Endotracheal tube Ø 6.5 mm - 29.5 cm	box of 10
34391	Cuffed Endotracheal tube Ø 7 mm - 31 cm	box of 10
34392	Cuffed Endotracheal tube Ø 7.5 mm - 31.5 cm	box of 10
34393	Cuffed Endotracheal tube Ø 8 mm - 33 cm	box of 10
34394	Cuffed Endotracheal tube Ø 8.5 mm - 33 cm	box of 10
34395	Cuffed Endotracheal tube Ø 9 mm - 33 cm	box of 10
34396	Cuffed Endotracheal tube Ø 10 mm - 33 cm	box of 10

Ø: Internal diameter

## EMERGENCY



Supplied with transport bag



34127

Weight: 540 g

### • 34127 EMERGENCY SCISSORS

23.5x10.8 cm

Autoclavable Stainless steel AISI 420.

## LISTER BANDAGE S/S SCISSORS



LISTER BANDAGE SCISSORS			
GIMA code	STAINLESS STEEL	GIMA code	FANTASY - COLOURED RING
34125	Lister - 11 cm	20501	Lister - Green ring - 14 cm
34129	Lister - 16 cm	20502	Lister - Lilac ring - 14 cm
34130	Lister - 18 cm	20509	Lister - Foot print - 14 cm
20500	Lister with belt clip - 14 cm	20511	Lister - Leopard - 14 cm
38530	Lister tungsten carbide - 14 cm	20512	Lister - Bubble - 14 cm
38532	Lister tungsten carbide - 18 cm	20513	Lister - Hearts - 14 cm

## STAINLESS STEEL UTILITY AND BANDAGES SCISSORS



Plastic coloured finger-contour handles for maximum comfort.

All purpose, first aid scissors, easily cut bandages, leather and plaster casts. Autoclavable at 136°C

UTILITY SCISSORS			
12 cm - 4.7"	16.5 cm - 6.5"	19 cm - 7.5"	Colour
20560	20570	20580	Black
-	20571	20581	Blue
-	20572	20582	Red
-	20573	20583	Purple
-	20574	20584	Pink
20590	Steel chain for scissors and forceps		20590



## AMBU® KING VISION® aBLADE™ VIDEO LARYNGOSCOPE

### 58106 KING VISION® aBLADE™ VIDEO LARYNGOSCOPE SET

The King Vision™ video laryngoscope is especially designed to visualize, in the most reliable way, the airways for routine and difficult intubations.

The reusable display is lightweight, non-glare, smudge-proof, packaged in a protective foam case and is battery operated. The blades are disposable and are individually packaged, eliminating cross contamination risks. Can be used continuously about 90 min., making it highly portable. Video output compatible with external monitor and recording devices.

**Two blade types:** a standard blade that requires the use of a stylet to direct the ET tube and a channeled blade where you can guide the ET tube with the blade.

### 58108 PEDIATRIC STANDARD aBLADES - size 2\* - box of 20

### 58109 PEDIATRIC CHANNELED aBLADES - size 2\* - box of 20

### 58110 VIDEO ADAPTER for aBLADES size 2 - optional

*Pediatric aBlades need 58110 (not included)*

### 58112 STANDARD VISION aBLADES - size 3\*\* - box of 20 - spare

### 58113 CHANNELED VISION aBLADES - size 3\*\* - box of 20 - spare

### 58116 VIDEO ADAPTER for aBLADES size 3 - spare

\* For children 1-10 years

\*\* For large children, adults

### STANDARD ACCESSORIES

- Vision display
- 1 reusable video adapter for aBlades size 3
- 4 channeled vision aBlades - size 3
- 2 standard vision aBlades - size 3
- 3 AAA batteries
- Case

Disposable channeled aBlade

Disposable standard aBlade



Full colour TFT LCD display anti-reflective

MADE IN USA

Protective gasket

Ergonomic design. Integrated blade/handle design for complete control

Channeled and standard disposable blades for guided or standard insertions

Guiding channel for easy ETT placement and removal

58106 Excellent optics

New anti-fog lens in every blade

## USB F.O. LED LARYNGOSCOPE HANDLE

### 34468 USB F.O. LARYNGOSCOPE HANDLE

Universal USB handle for all green fibre optic blades, including lithium-ion rechargeable battery and USB port for easy recharging without charging station.

- glass bead blasted, matt chromium plated surface for a high quality optic

- no surface structure, lateral grooves for hygienic use and secure grip in the hand

- metallic lamp case

- quick and easy removal of bulb

- autoclavable up to 134° (without batteries)

- handle in accordance with ISO 7376 (green standard)



USB port

MADE IN GERMANY

COMPATIBLE WITH ALL ISO 7376 GREEN F.O. BLADES



34468



Handle supplied in a rigid case with 3 adapters (US, GB, EU)

## F.O. LARYNGOSCOPE BLADES AND BATTERY HANDLES SINGLE PATIENT STERILE

### SINGLE PATIENT F.O. LARYNGOSCOPE BLADES

Choice of 7 blades Miller 0,1 and McIntosh 1, 2, 3, 4, 5 for everyday hospital use. Compatible with ISO 7376 Green System. Low profile helps to reduce dental trauma, improves access with limited mouth opening and larynx visualization. Beaded tip on McIntosh blades for easy intubation. Slimmer design for easy maneuverability and intubation.

Light conductor made from material with excellent light transmission: 4,000 lux with 2.5 V Xenon lamp and 10,000 lux with LED lamp. Need F.O. handle.

Instructions: GB, FR, IT, ES, PT, DE, GR, Arabic

*A high impact resistant plastic block coupled with metal spatula provides great strength to the whole blade comparable to all metal reusable blades*

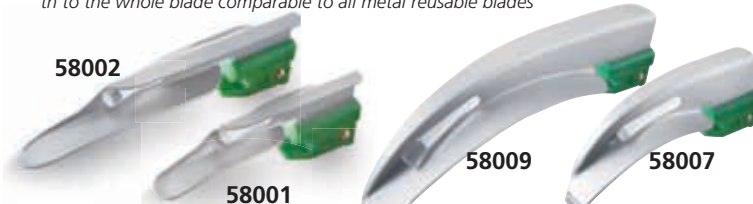

GIMA code	SINGLE PATIENT F.O. BLADES	A	B
58001	MILLER N° 0 blade - Newborn	78	54
58002	MILLER N° 1 blade - Infant	105	81
58006	Mc INTOSH N° 1 blade - Infant	95	69
58007	Mc INTOSH N° 2 blade - Child	115	89
58008	Mc INTOSH N° 3 blade - Adult	134	108
58009	Mc INTOSH N° 4 blade - Adult large	155	129
58010	Mc INTOSH N° 5 blade - Adult extra large	175	149

### SINGLE PATIENT BATTERY HANDLES

- lightweight, suitable for everyday hospital use

- single patient use, prevent cross infection

- compatible with ISO 7376 Green System

- perfect solution to cleaning problems confronting EMS field

- Ready To Use (RTU) handles (58016-17) are supplied with disposable eco-friendly preloaded batteries

- suitable also for reusable blades

Multilingual manual: GB, FR, IT, ES, PT, DE, PL, SK.



58016

58017

145K LUX	SINGLE PATIENT F.O. LED BATTERY HANDLES 2.5 V
-	Battery handle "C" type - adult - without batteries
58016	Battery handle "RTU" (ready to use) - pediatric
58017	Battery handle "RTU" (ready to use) - adult
TECHNICAL SPECIFICATIONS	
CRI:	>110 Material: ABS
Temperature:	4500K Batteries: mercury free
Lux:	145K

# HEINE CLASSIC+® F.O. XHL OR LED<sup>HQ</sup> LARYNGOSCOPES

## HEINE CLASSIC+® F.O. XHL OR LED<sup>HQ</sup> LARYNGOSCOPES

The "Classic+" range of F.O. blades with HEINE HiLite® Fibre bundle with over 6,500 individual micro-fibres offer improved light transmission and longer life. Together with the innovative HEINE LED<sup>HQ</sup> light in the handle or the traditional XHL Xenon Halogen Bulb, the exclusive HEINE HiLite® Fibre Optic bundle with up to 4.3 mm of Ø offers 3X or 40% brighter light as with other conventional halogen bulbs.

**5 years warranty** 5-years guarantee or 4,000 standard autoclave cycles of 134°C/5 min. with more than 1,000 lux on all blades with HEINE HiLite® fibre bundle.

**Long lasting bulbs** HEINE XHL® Xenon Halogen bulbs incorporate the latest Xenon Halogen Technology to give you up to 40% more light! XHL 3.5 V bulbs last up to twice as long as 2.5 V bulbs and give up to three times the light of conventional 2.5 V Halogen laryngoscope bulbs. HEINE LED<sup>HQ</sup> handles offer even three times the light intensity of the 3.5V Xenon Halogen bulbs for an outstanding and constant bright illumination.

**Long lasting 3.5 V rechargeable batteries** HEINE 3.5 V systems (LED<sup>HQ</sup> or XHL) use a long-lasting 3.5 V lithium rechargeable battery. HEINE F.O. laryngoscope blades and handles are compatible with the ISO 7376 (green standard).

• **34374 NT 4 CHARGER UNIT FOR 2 HANDLES - X-002.99.494**



**34374** Size: 14x6x6.6 cm

Two independent charging compartments:  
 - fast charge capability:  
 - 2 hours for Li-ion handle  
 - automatic charging  
 - charger indicator

GIMA code	HEINE code	HEINE FIBRE OPTIC BLADES	Overall length	Distal length
34411	F-000.22.119	MILLER 00	76 mm	9.5 mm
34412	F-000.22.120	MILLER 0	80 mm	10.5 mm
34413	F-000.22.121	MILLER 1	100 mm	11.5 mm
34414	F-000.22.122	MILLER 2	152 mm	13 mm
34415	F-000.22.110	PAED 0	82 mm	12 mm
34416	F-000.22.111	PAED 1	95 mm	13 mm
34417	F-000.22.100	MAC 0	82 mm	9 mm
34418	F-000.22.101	MAC 1	93 mm	11 mm
34419	F-000.22.102	MAC 2	115 mm	13 mm
34420	F-000.22.103	MAC 3	135 mm	15 mm
34421	F-000.22.104	MAC 4	155 mm	15 mm
34422	F-000.22.105	MAC 5	176 mm	15 mm
34423	F-000.22.313	MAC 3 - Flex Tip+	115 mm	13.2 mm
34368	F-000.22.314	MAC 4 - Flex Tip+	137 mm	13.2 mm
34361	F-000.22.763	XP MAC 3 - disposable - box of 25	134 mm	14 mm
34362	F-000.22.764	XP MAC 4 - disposable - box of 25	154 mm	14 mm

### HEINE STANDARD LARYNGOSCOPE HANDLES AND ACCESSORIES

34430	F-001.22.800	Slim F.O. handle 2.5 V - pediatric
34400	F-001.22.812	Short F.O. handle 2.5 V - pediatric and obese
34401	F-001.22.860	Standard F.O. handle 2.5 V
34405	F-008.22.860	Standard F.O. LED handle 2.5 V
34370	F-008.22.820	EasyClean® LED handle - 100% waterproof
31769	X-001.88.035	Spare bulb 2.5 V for 34400, 34401, 34430
31768	X-002.88.044	Spare bulb 3.5 V for 34369

### HEINE RECHARGEABLE LARYNGOSCOPE HANDLES AND BATTERIES

34371	F-008.22.804	Pediatric LED handle 2.5 V Li-ion with recharg.* battery
34372	F-007.22.894	Standard F.O. handle 3.5 V Li-ion with recharg.* battery
34373	F-008.22.894	Standard LED handle 3.5 V Li-ion with recharg.* battery
34378	X-007.99.104	Re-chargeable 2.5 V battery pediatric for 34371 - spare
34448	X-007.99.383	Re-chargeable 3.5 V battery for 34372-3, 34402, 34367 - spare

\*Need NT4 charger unit code 34374

### HEINE CLASSIC+® FIBRE OPTIC LARYNGOSCOPE SETS\*\* with 2.5V handle

34403	F-119.10.860	3 blades set with Paed 1, Mac 2, Mac 3, XHL handle
34404	F-120.10.860	4 blades set with Paed 1, Mac 2, Mac 3, Mac 4, XHL handle
34446	F-120.18.860	4 blades set with Paed 1, Mac 2, Mac 3, Mac 4, LED <sup>HQ</sup> handle
with 3.5V rechargeable handle		
34367	F-119.94.865	3 blades set with Paed 1, Mac 2, Mac 3, LED HQ rechargeable handle

\*\*Set includes spare bulb and F.O. handle 2.5 V (34401) or F.O. LED handle 2.5 V

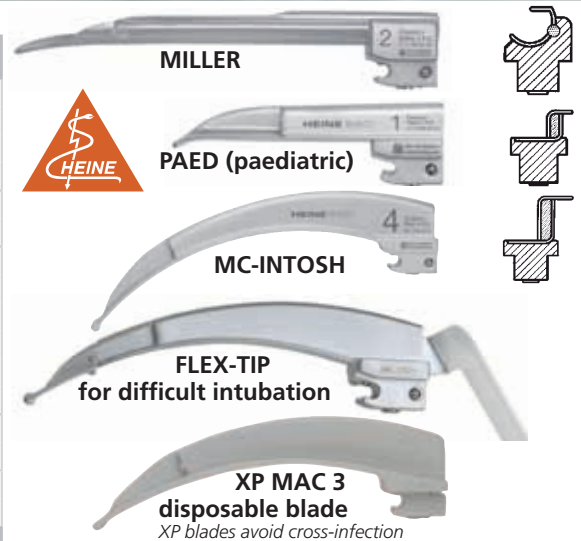

**STANDARD HANDLE 3.5V LED Li-ion®**  
 Rechargeable 3.5V F.O. LED handle with charge status display in bottom cap. State of charge is indicated for 10 seconds after switching on or after removing from the charger. Two hours charging time with NT4 charger; up to 13 hours ON time. 12,000 LUX at 40 mm.



**EASYSLEAVE® LED HANDLE**  
 LED Handle for low-temperature gas plasma sterilisation (STERRAD®/STERIS®). 100% waterproof (IP68) for easy wiping and immersion disinfection. No disassembly required. Easy-to-wipe "wave design" Autoclavable LED technology: no light removal during disinfection, just batteries. 10 hours operating time with 2x batteries (not included).

**LED HANDLES:**  
 - 5,000 Kelvin  
 - 50,000 hours bulb life

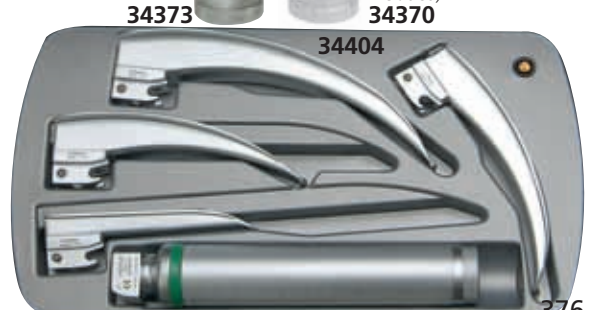

# GIMA GREEN F.O. XENON/HALOGEN AND LED LARYNGOSCOPES



## GIMA GREEN LARYNGOSCOPES

- maximum light transmission thanks to durable and high quality fibres
- specially designed blades for easy intubation
- matt finished to reduce glare
- autoclavable up to 134°C for 5 minutes. Blades autoclavable up to 2,000 times
- compatible to plasma sterilization
- all blades are compatible to BS EN ISO 7376 Green standard handles
- all blades are made of Austenitic Stainless steel thereby making them rust proof
- long life blades. GIMA offers 3 years Warranty
- a large selection of power sources to use: 'AA' and 'C' type batteries
  - or 2.5 V and 3.5 V rechargeable batteries
  - 2.5 V handles can be used with standard or rechargeable batteries
- handles are available with 2.5 V and 3.5 V Xenon/Halogen and LED bulbs
- all blades are non magnetic

### Mc INTOSH BLADES

### MILLER BLADES



### MAXLITE

### GIMA GREEN

#### Gima Green and Maxlite: Miller and Mc-Intosh blades

- Gima Green 4.0 mm Ø F.O. bundle with more than 5,500 individual fibre strands
- Miller Maxlite 3.0 mm Ø bundle with more than 5,000 individual fibre strands
- McIntosh Maxlite 4.5 mm Ø bundle with more than 6,500 individual fibre strands

#### High quality fibres ensuring excellent light transmission Gima Green and Miller

**Maxlite:** 7,000 lux with 2.5 V Xenon/Halogen lamp, 12,500 lux with 3.5 V Xenon/Halogen lamp, 18,000 lux with 2.5 LED lamp, 30,000 lux with 3.5 V LED lamp

**McIntosh Maxlite:** 8,000/14,000/20,000/40,000 lux

GIMA code	"GIMA MAXLITE" FIBRE OPTIC BLADES	A	B
58051	MILLER N° 0 blade - Newborn	80	55
58052	MILLER N° 1 blade - Infant	100	75
58056	Mc INTOSH N° 0 blade - Newborn	82	57
58057	Mc INTOSH N° 1 blade - Infant	93	68
58058	Mc INTOSH N° 2 blade - Child	115	90
58059	Mc INTOSH N° 3 blade - Adult	135	110
58060	Mc INTOSH N° 4 blade - Adult large	155	130
58061	Mc INTOSH N° 5 blade - Adult x-large	176	151

GIMA code	"GIMA GREEN" FIBRE OPTIC BLADES*	A	B
34460	MILLER N° 00 OXY blade - Premature	65	40
34461	MILLER N° 0 blade - Newborn	78	53
34462	MILLER N° 1 blade - Infant	102	77
34463	MILLER N° 2 blade - Child	155	130
34464	MILLER N° 3 blade - Adult	195	170
34469	Mc INTOSH N° 0 blade - Newborn	80	55
34470	Mc INTOSH N° 1 blade - Infant	92	67
34471	Mc INTOSH N° 2 blade - Child	100	75
34472	Mc INTOSH N° 3 blade - Adult	130	105
34473	Mc INTOSH N° 4 blade - Adult large	155	130
34474	Mc INTOSH N° 5 blade - Adult x-large	175	150

\*equipped with detachable fibre optic light guide

#### F.O. LIGHT GUIDE FOR GIMA GREEN BLADES

- 34483 F.O. Light guide for "GIMA Green" Mc Intosh N° 3
- 34484 F.O. Light guide for "GIMA Green" Mc Intosh N° 4
- 34486 F.O. Light guide for "GIMA Green" other - specify code

• **31542 GIMA GREEN CHARGING STATION - 100/240 V - 50/60 Hz**  
It can charge either 2.5 V / 3.5 V NiCa, NimH or Li-ion rechargeable batteries independently of their status of charge. Unit is designed to prevent over charging of batteries. Simultaneously charging of pediatric and adult handle.

Multilingual manual:  
GB, FR, IT, ES

**31542**



Charging station includes pediatric adaptor, wall support, UK, US and EU plug

### HALOGEN/XENON BATTERY HANDLE

### LED BATTERY HANDLE



#### Xenon/Halogen and LED handles 2.5 V and 3.5 V

- closed battery compartment prevent liquid penetrating inside the battery
- handles are supplied with lamp. Battery not included
- solid metal handle of chromium plated metal

#### GIMA GREEN RECHARGEABLE BATTERY HANDLES

GIMA code	F.O. XENON/HALOGEN BATTERY HANDLES - 2.5 V
34480	Pediatric rechargeable metal handle (2xAA) - 2.5 V
34481	Adult rechargeable metal handle (2xC) - 2.5 V
34466	Pediatric rechargeable Li-Ion battery 2.5 V 1,000 mAh
34467	Adult rechargeable Li-Ion battery 2.5 V 2,200 mAh
34485	Halogen bulb 2.5 V (minimum order 6 pcs)

#### "GIMA GREEN" RECHARGEABLE HANDLES AND BATTERIES 3.5 V - OLD up to lot 8 (ped handle) up to lot 7 (adult handle)

34489	Pediatric rechargeable NiCa battery 3.5 V/700 mAh for 34487
34491	Halogen Bulb 3.5 V

#### F.O. XENON/HALOGEN BATTERY HANDLE 3.5 V

34456	Pediatric rechargeable metal handle (3.5 V)
34457	Adult rechargeable metal handle (3.5 V)
31540	Pediatric rechargeable Li-ion battery** 3.5 V for 34456, 34487***
31541	Adult rechargeable Li-ion battery** 3.5 V for 34457, 34482, 34488****
**for handles sold after may 2013 ***since lot 10 ****since lot 12	
34491	Halogen Bulb 3.5 V

#### F.O. LED BATTERY HANDLES 2.5 V AND 3.5 V\*

34476	Pediatric LED rechargeable handle 2.5 V
34477	Adult LED rechargeable handle 2.5 V
34482	Adult rechargeable metal handle - LED light 3.5 V

\*LED bulb is assembled with handle in a fixed system and is not replaceable

#### COMPATIBILITY HANDLE - BATTERY - BULB

GIMA code	Handle		V	Battery			Bulb
	Xenon	LED		Standard 2xAA	Rechargeable 2xC	Li-ion*	
34480	Ped.	-	2.5	yes	no	34466	34485
34481	Adult	-	2.5	no	yes	34467	34485
34456	Ped.	-	3.5	no	no	31540	34491
34457	Adult	-	3.5	no	no	31541	34491
34476	-	Ped.	2.5	yes	no	34466	-
34477	-	Adult	2.5	no	yes	34467	-
34482	-	Adult	3.5	no	no	31541	-

\*Li-ion batteries have twice the capacity of an equivalent size NimH batteries.

# GIMA GREEN F.O. XENON/HALOGEN, LED LARYNGOSCOPE SETS



Multilingual box and manual:  
GB, FR, IT, ES, PT, GR, DE, PL,  
RO, Arabic.

## GIMA F.O. XENON/HALOGEN AND LED SETS

- F.O. laryngoscopes provide cool bright illumination
- Gima Green F.O. blades with detachable fibre or Maxlite F.O. blades with integrated fibre
- Xenon/Halogen or LED F.O. rechargeable battery handle - 2.5 V or 3.5 V rechargeable battery handle (battery not included). 2.5 V rechargeable battery handle can be used with standard or rechargeable batteries. Rechargeable battery handles should be used with charging station 31542 (not included).
- non magnetic blades

### LARYNGOSCOPE SET WITH F.O. BLADES

GIMA code	GIMA GREEN F.O. XENON/HALOGEN SET - 2.5 V	
34451	Pediatric set	2 blades Miller 0-1
34454	Pediatric set	3 blades Miller 0-1, Mc Intosh 0
34452	Adult set	3 blades Mc Intosh 2-3-4
34453	Adult set	4 blades Mc Intosh 1-2-3-4
34455	Doctor set	3 blades Miller 1-2-3
34485	Halogen bulb 2.5 V (minimum order 6 pcs)	
34450	Empty box without sponge	
GIMA code	GIMA GREEN F.O. LED SET - 2.5 V OR 3.5 V	
34327	Adult set	3 blades Mc Intosh 2-3-4 - 2.5 V
34328	Adult set	4 blades Mc Intosh 1-2-3-4 - 2.5 V
34329	Adult set	3 blades Mc Intosh 2-3-4 - 3.5 V
34330	Adult set	4 blades Mc Intosh 1-2-3-4 - 3.5 V

## MAXLITE F.O. BLADE WITH INTEGRATED FIBRE

Built with an integrated F.O. bundle with no cavities to trap dirt or body fluids, this allowing the blade to be easily cleaned and decontaminated.



GIMA GREEN F.O. BLADE

### TECHNICAL SPECIFICATIONS - BLADES AND BULBS

	Gima Green F.O. blade	Maxlite F.O. Mc Intosh blade
Fibre light carrier:	detachable	integrated
F.O. bundle Ø:	4.0 mm	4.5 mm
Individual fibre strands:	> 5,500	> 6,500
Light transmission with 2.5 V (Xenon):	7,000 lux	8,000 lux
Light transmission with 2.5 V (LED):	18,000 lux	20,000 lux
Light transmission with 3.5 V (Xenon):	12,500 lux	14,000 lux
Light transmission with 3.5 V (LED):	30,000 lux	40,000 lux
Autoclavable at 134 °C:	2,000 times	2,000 times
LED bulb life:	50,000 hours	50,000 hours

### LARYNGO SET WITH F.O. BLADES - INTEGRATED FIBRE

GIMA code	MAXLITE F.O. XENON/HALOGEN SET - 2.5 V	
34332	Pediatric set	3 blades Miller 00-0-1
34333	Adult set	3 blades Mc Intosh 1-2-3
34334	Adult set	4 blades Mc Intosh 1-2-3-4
34485	Halogen bulb 2.5 V (minimum order 6 pcs)	
GIMA code	MAXLITE F.O. LED SET - 2.5 V or 3.5 V	
34336	Pediatric set	3 blades Miller 00-0-1 - 2.5 V
34335	Adult set	3 blades Mc Intosh 2-3-4 - 2.5 V
34337	Adult set	4 blades Mc Intosh 1-2-3-4 - 2.5 V
34338	Adult set	4 blades Mc Intosh 1-2-3-4 - 3.5 V
GIMA code	BATTERIES for GIMA GREEN and MAXLITE	
34466	Pediatric rechargeable Li-ion battery 2.5 V 1,000 mAh	
34467	Adult rechargeable Li-ion battery 2.5 V 2,200 mAh	
31541	Adult rechargeable Li-ion battery 3.5 V*	

\*Packed and shipped at half charged state

# MAXLITE FLEXTIP F.O. XENON/HALOGEN OR LED SETS AND BLADES

## XENON-HALOGEN OR LED F.O. FLEXTIP LARYNGOSCOPE SETS WITH INTEGRATED FIBRES FOR DIFFICULT INTUBATIONS

Deluxe set including one F.O. rechargeable handle, one or two F.O. Mc Intosh blades N° 3 or N° 3 and 4 and bulb. The movable blade tip facilitates lifting of the epiglottis and enables a perfect visibility of the intubation process even in case of difficult anatomical conditions. A better visibility and a lower lever force reduce the risk of injury of the larynx and the teeth.

- stainless steel construction, matt finish
- can be used with all Green Spec Handles
- compatible with ISO 7376 Green Standards
- channel provides improved viewing area
- 4.5 mm fibre bundle with more than 6,500 individual fibre strands
- high quality fibres ensuring excellent light transmission, 8,000 lux with 2.5V Xenon lamp, 20,000 lux with 2.5V LED lamp
- 2x"C" batteries or rechargeable batteries (not included)
- autoclavable at 134° C, approximately 2,000 times
- can sustain Plasma sterilization (Sterrad 100 NX)

GIMA code	MAXLITE FLEXTIP F.O. SETS - 2.5 V with integrated fibres	
58070	MAXLITE F.O. XENON FLEXI SET	1 blade Mc Intosh 3
58072	MAXLITE F.O. XENON FLEXI SET	2 blades Mc Intosh 3-4
58073	MAXLITE F.O. LED FLEXI SET	1 blade Mc Intosh 3
34498	MAXLITE F.O. LED FLEXI SET	2 blades Mc Intosh 3-4

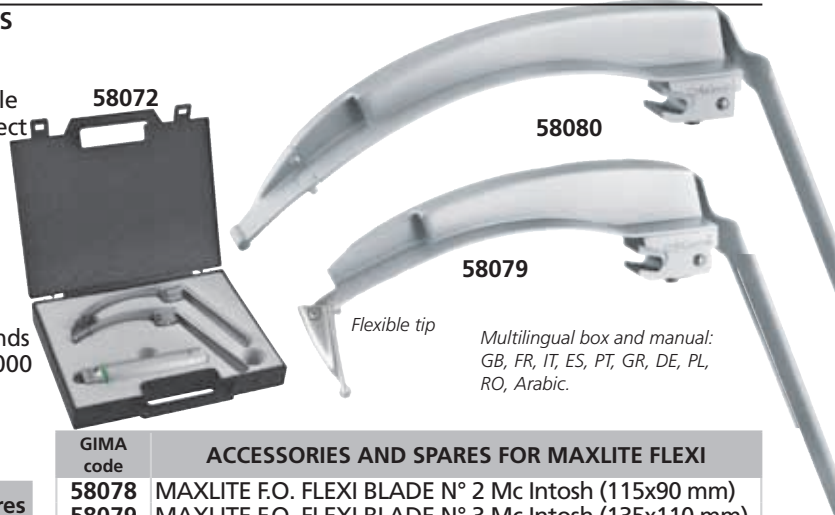

GIMA code	ACCESSORIES AND SPARES FOR MAXLITE FLEXI	
58078	MAXLITE F.O. FLEXI BLADE N° 2	Mc Intosh (115x90 mm)
58079	MAXLITE F.O. FLEXI BLADE N° 3	Mc Intosh (135x110 mm)
58080	MAXLITE F.O. FLEXI BLADE N° 4	Mc Intosh (155x130 mm)
34485	Bulb 2.5 V - spare	
34467	Adult rechargeable Li-ion battery 2.5 V	
31542	Charging station 100-240 V - see page 377	

# STANDARD LARYNGOSCOPE BLADES AND SETS - 2.5 V

## McINTOSH BLADES



## MILLER BLADES

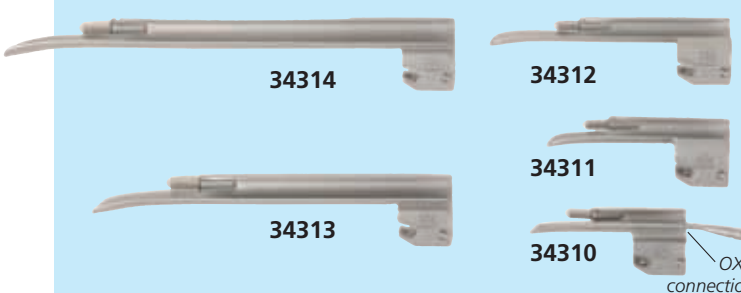

**3 YEARS WARRANTY**

Multilingual box and manual: GB, FR, IT, ES, PT, DE, PL, RO, GR, Arabic.

- Great features of the unique GIMA blades and handles
- standard 2.5 V vacuum bulb
  - light ergonomic, satin finish handle to reduce glare
  - Stainless Steel contacts guarantee long working life
  - easy sterilization ETO or steam
  - full range of Mc Intosh & Miller blades, latex free
  - ISO 7376 fittings allow use of blades with existing handles
  - set is packaged in an anti-shock case and in cardboard box
  - 2.5 V handles work with both alkaline batteries or rechargeable batteries
  - good light transmission of 3,500 LUX with 2.5 V handles
  - autoclavable up to 134° for 5 minutes (approx. 2,000 times)
  - non magnetic blades

GIMA code	STANDARD BLADES	Overall Length mm	Distal Width mm
34310	Blade N° 00 MILLER OXY - premature	65	11.5
34311	Blade N° 0 MILLER - premature/newborn	78	11.5
34312	Blade N° 1 MILLER - babies	102	11.5
34313	Blade N° 2 MILLER - adults	155	16.5
34314	Blade N° 3 MILLER - adults/large	195	16.5
34317	Blade N° 0 Mc INTOSH - newborn	80	11
34318	Blade N° 1 Mc INTOSH - babies	95	10
34319	Blade N° 2 Mc INTOSH - infants	115	12
34320	Blade N° 3 Mc INTOSH - adults	134	14
34321	Blade N° 4 Mc INTOSH - adults/large	155	14
34322	Blade N° 5 Mc INTOSH - adults/extra large	175	14

GIMA code	STANDARD RECHARGEABLE SETS (HANDLE+BLADES)	
34301	Pediatric set	2 blades MILLER 0-1
34307	Pediatric set	3 blades MILLER 00-0-1
34305	Pediatric set	3 blades MILLER 0-1, Mc INTOSH 0
34306	Doctor set	3 blades MILLER 1, 2, 3 - adult handle
34302	Adult set	3 blades Mc INTOSH 2-3-4
34303	Adult set	4 blades Mc INTOSH 1-2-3-4

GIMA code	BULBS, BATTERIES AND RECHARGEABLE HANDLES	
34352	Small rechargeable handle - pediatric (2xAA) - 2.5 V	
34354	Large rechargeable handle - adult (2XC) - 2.5 V	
34466	Pediatric rechargeable Li-ion battery 2.5 V AA	
34467	Adult rechargeable Li-ion battery 2.5 V "C"	
<i>Charging time 2.5 hours (34466), 5 hours (34467)</i>		
31542	Charging station (including pediatric adaptor, wall support, UK, US and EU plug) 100-240 V	
34324	Small Bulbs for Mc. Int. N°0 and MILLER N°00,	
34325	Large Bulbs for Mc. Int. N°1,2,3,4 and MILLER N°2,3	
<i>compatible with Kawe and Riester</i>		



# DISPOSABLE F.O. LARYNGOSCOPE BLADES MILLER AND MC INTOSH

## SINGLE-PATIENT USE LARYNGOSCOPE F.O. BLADES

Choice of 5 different blades: Mc Intosh N° 2, 3, 4 and Miller N° 0,1. All blades are tested for tensile strength. Individually packed, non sterile.

**COMPATIBILITY WITH ALL "GREEN" F.O. SYSTEMS**

GIMA code	DISPOSABLE BLADES NON STERILE	Overall Length mm	Distal Width mm
34481	Metal handle		
34364	Plastic handle		
34365	N° 0 Miller - infant	90	22
34366	N° 1 Miller - child	100	23.3
34375	N° 2 Mc Intosh - adult small	115	34.4
34376	N° 3 Mc Intosh - adult	132	40.6
34377	N° 4 Mc Intosh - adult large	155	58.7
34359	Bulb for old plastic handle sold up to may 2016		
34358	Bulb for new plastic handle sold since june 2016		



- 34381 EMERGENCY PACK: plastic handle +3 disposable blades Mc Intosh N° 2,3,4
- 34382 NYLON BAG - empty
- 34384 EMERGENCY CASE: plastic handle+6 disposable blades Miller 0,1,2 and Mc Intosh 2,3,4.





## BURNFREE® - BURN CARE PRODUCTS

A complete range of burn care products with superior benefits:

- dissipates heat on contact
- cools the burn site, relieves pain, calms the burn victim, helps stop the burn process
- covers the burn, helps to prevent contamination
- accommodates swelling or the need to flex joints thanks to elastic texture

**Sterile burn and wounds dressings**  
Made of a soft open-cell, non-adherent, inert foam, saturated with Burnfree® gel, does not leave residues imbedded in the wound. Without lidocaine, which makes it suitable for children.

### Sterile burn and wounds dressings

Made of a soft open-cell, non-adherent, inert foam, saturated with Burnfree® gel, does not leave residues imbedded in the wound. Without lidocaine, which makes it suitable for children.

GIMA code	BURNFREE® PRODUCTS
34869	Burn Dressing - 5x5 cm - box of 120 pcs
34870	Burn Dressing - 5x15 cm - box of 10 pcs
34871	Burn Dressing - 10x10 cm - box of 10 pcs
34872	Burn Dressing - 20x20 cm - box of 5 pcs
34873	Burn Dressing - 30x30 cm - box of 20 pcs
34875	Pain Relieving Gel - bottle 120 ml
34883	Pain Relieving Gel - 3.5 g sachets - box of 20 pcs
34882	Pain Relieving Gel - 3.5 g sachets - box of 1,000 pcs
34878	Burn Kit (2 sterile dressing 5x15 cm and 2 10x10 cm, 1 gel bottle 120 ml, 20 gel sachets 3.5g and 2 rollers gauzes)

### Pain relieving gel

Ideal for all minor burns (including sunburns), cuts and abrasions, available in bottle or single use dose 3.5 g.



## EMERGENCY BLANKET

### • 34086 SICURTREK EMERGENCY BLANKET

All-purpose emergency blanket. Waterproof, anti-putridic, protects from cold and/or heat.



Made of polypropylene Fralom fibre coupled to metallized polyethylene fibre.

Blanket colour availability may change in the time

Size:  
200x150 cm

## ISOTHERMIC COVER

### • 34085 EMERGENCY COVER

Suitable for protection against cold and heat. Silver side in keeps the warmth of the body, gold side out reflects sunbeams.



Size: 160x210 cm  
Weight: 63 g

Radio transparent

Instructions:  
GB, FR, IT, ES, PT, DE, HU, RO, SE, FI, GR, HR, Arabic

## BURNFREE® - FIRE BLANKET

### BURNFREE FIRE/TRAUMA BLANKETS

Fire/trauma blanket for first aid treatment of burn injuries. It provides physical protection from heat, fire and smoke. It draws the heat out to prevent further tissue and nerve damage.

- it stops the burning process
- it removes heat from burn site
- it extinguishes small fires
- medical grade ingredients.

Blanket rapidly cools and soothes the burn. Supplied with bag.



Bags with strap for easy transport (34880-1 only)

GIMA code	Blanket Size	Weight
34879	91x76 cm	2.3 kg
34880	183x152 cm	6.9 kg
34881	244x152 cm	10.9 kg

## FIRE RETARDANT BLANKET

### • 34087 FIRE RETARDANT BLANKET

Made of glass fibre. Can be used to extinguish small fires. Size: 150x180 cm Standard EN1869 1997.



## INSTANT ICE: SPRAY OR BAG IN TNT OR PE



Instant ice with multilingual bag: GB, FR, IT, ES.



34110 TNT

34111 PE

34112

- 34110 INSTANT ICE - TNT 14x18 cm bag (non woven fabric)
- 34111 INSTANT ICE - PE 14x18 cm bag (polyethylene)

minimum order: pack of 25 bags. (38x25xh 17 cm)

Icy-pack "instant ice" is recommended for cryotherapy. Excellent in case of traumas to soothe the pain and to prevent haematomas, swellings, etc.

**Easy and quick to use anywhere and anytime.**

Press the bag to break the inner bubble and shake to mix contents. The blend you obtain drops temperature of the pack down. Activates at -4°C, reaches 0°C in 30 minutes (at environment temperature of 20 °C). Weight 250 g.

- 34112 SPRAY INSTANT ICE - bottle 400 ml

Ecological, useful for small bruises, haematomas or trauma, in first aid or sport applications. Spray on the injured area at 20 cm distance.

Content: gas (isobutane, butane, propane), liquid (menthol).

**EMERGENCY KITS COMPLETE WITH STANDARD EMERGENCY DEVICES**



34173

- SMART BAGS POLYESTER PVC COATED - medium - blue**
- 27152 SMART BAG - medium empty - 55x35xh 32 cm
  - 34173 "GIMA 3" EMERGENCY BAG - filled - without cylinder



34174

- SMART BAGS POLYESTER PVC COATED - large - red**
- 27153 SMART BAG - large empty - 65x35xh 35 cm
  - 34174 "GIMA 7" EMERGENCY BAG - filled



34163

- LOGIC 2 RUCKSACKS POLYESTER PVC COATED - red**
- 27171 LOGIC 2 RUCKSACK - empty - 40x25xh 47 cm
  - 34162 "GIMA 8" EMERGENCY RUCKSACK - filled
  - 34163 "GIMA 9" EMERGENCY RUCKSACK - filled
  - 34164 "GIMA 10" EMERGENCY RUCKSACK - filled - without cylinder
  - 34175 "GIMA 11" EMERGENCY RUCKSACK - filled

- LOGIC 2 RUCKSACKS PVC - red**
- 27172 LOGIC 2 RUCKSACK PVC - empty - 40x25xh 47 cm
  - 34165 "GIMA 12" EMERGENCY RUCKSACK PVC - filled - same as "GIMA 9", without cylinder



27172

- EMERGENCY ALUMINIUM CASE**
- 34159 ALUMINIUM CASE - empty - 40x35x10 cm
  - 34161 "GIMA 2" EMERGENCY CASE - filled



34161

Aluminium emergency case



34156

- EMERGENCY BAGS POLYESTER PVC COATED - red**
- 27165 EMERGENCY BAG - empty - 35x45x21 cm
  - 34155 "GIMA 6" EMERGENCY BAG - filled - without cylinder
  - 34156 "GIMA 4" EMERGENCY BAG - filled
  - 34157 "GIMA 5" EMERGENCY BAG - filled

- EMERGENCY BAGS PVC - blue**
- 27167 EMERGENCY BAG PVC - empty - 35x45x21 cm
  - 34154 "GIMA 13" EMERGENCY BAG PVC - filled - same as "GIMA 4", without cylinder



27167



34176

- IP67 CERTIFIED DURABLE CASE - waterproof and dustproof**
- 27222 LARGE DURABLE CASE - empty - 55x43xh 21 cm
  - 34176 "GIMA 1" EMERGENCY DURABLE CASE - filled

## EMERGENCY KITS - BAGS, RUCKSACKS, CASES

KIT CONTENTS	Size cm	34155	34156	34157	34154	34173	34174	34161	34176	34162	34163	34164	34175	34165
		GIMA 6 bag	GIMA 4 bag	GIMA 5 bag	GIMA 13 bag	GIMA 3 bag	GIMA 7 bag	GIMA 2 al case	GIMA 1 pl case	GIMA 8 rucksack	GIMA 9 rucksack	GIMA 10 rucksack	GIMA 11 rucksack	GIMA 12 rucksack
<b>Container (bag, rucksack or case)</b>														
Smart bag - medium - blue 600D polyester (27152)	55x35xh 32					•								
Smart bag - large - red 600D polyester (27153)	65x35xh 35						•							
Emergency bag - red 600D polyester (27165)	35x45xh 21	•	•	•										
Emergency bag - blue PVC (27167)	35x45xh 21				•									
Logic 2 rucksack - red 600D polyester (27171)	40x25xh 47								•	•	•	•		
Logic 2 rucksack - red PVC (27172)	40x25xh 47													•
Durable case - orange (27222)	55x43xh 21								•					
Aluminium case (34159)	40x35xh 10							•						
<b>Products included in kits</b>														
Emergency cover (34085)		•	•	•	•	•	•	•	•	•	•	•	•	•
Universal scissors - 16.5 cm (20571)		•	•	•	•	•	•	•	•	•	•	•	•	•
Facemask n. 2 - child/small (34222)		•	•	•	•	•	•	•	•	•	•	•	•	•
Silicone resuscitator bag with mask n 4 - adult (34245)		•	•	•	•	•	•	•	•	•	•	•	•	•
Teeth screw driver (34273)		•	•	•	•	•	•	•	•	•	•	•	•	•
Tongue holding forceps (34274)		•	•	•	•	•	•	•	•	•	•	•	•	•
Oxygen tube - 120 cm (34276)		•	•	•	•	•	•	•	•	•	•	•	•	•
Mixed Guedel airways - box of 10 (34439)		•	•	•	•	•	•	•	•	•	•	•	•	•
Oxygen therapy mask - adult (34166)		•	•	•	•	•	•	•	•	•	•	•	•	•
0.5 l oxygen cylinder (empty) with reducer UNI std (34501)		•	•	•	•	•	•	•	•	•	•	•	•	•
Trad single head stethoscope (32561)		•	•	•	•									
Jotarp dual head stethoscope - black (32580)						•		•	•	•	•	•	•	•
Yton sphygmomanometer (32720)		•	•		•									
London sphygmomanometer (32725)				•		•	•	•	•	•	•	•		•
Welch Allyn DURASHOCK sphygmomanometer (32700)														•
Emergency pack - 3 F.O. single-use blades+plastic handle (34381)		•	•		•					•				
Laryngoscope set 3 Mc-Intosh blades 2-3-4 (34302)				•		•	•		•		•	•		•
"Gima green" F.O. laryngoscope set 4 Mc-Intosh blades 1-2-3-4 (34453)														•
Hand suction unit (28180)		•		•		•	•		•		•	•	•	•
Delta pen light (25629)				•		•	•				•	•	•	•
Fast tourniquet - green (25728)				•		•	•		•		•	•	•	•
Magill forceps - 20 cm (34002)				•		•	•		•		•	•	•	•
Gima digital thermometer °C (25560)				•		•	•		•		•	•	•	•
Disinfectant wipes - tube 100 wipes (36625)				•		•	•		•		•	•	•	•
Emocontrol elastic bandage (34782)				•		•	•		•		•	•	•	•
Gauze bandage 3.5 m x 7 cm - box of 10 (34841)				•		•	•		•		•	•	•	•
Sterile adhesive dressing 10 x 10 cm - box of 5 (34819)				•		•	•		•		•	•	•	•
Oxy-4 fingertip oximeter (35092)						•	•		•		•	•	•	•
Instant ice - bag 3 pcs. (34111)						•	•		•		•	•	•	•
Burn dressing - 10x10 cm (34871)								•			•	•		•
3 E3 padded pouches with window red (27188), blue (27189), green (27191)									•					
2 E4 pouches with window red (27192), yellow (27194)									•					

## INTUBATION BAG WITH EMERGENCY ACCESSORIES

- 27133 INTUBATION BAG - empty
  - 34152 INTUBATION KIT - complete
  - 34153 INTUBATION KIT F.O. - complete
- Compact nylon bag suitable for various uses:  
2 internal zip pockets, 9 elastic retainers for instruments, made of water-resistant anti-scratch 600D polyester, blue colour.  
Size: 32x22.5xh 7.5 cm.

STANDARD ACCESSORIES	34152	34153
Mc Intosh Laryngoscope s/s blades N 1, 2, 3	3	3 F.O.
Laryngoscope metal handle	1	1
Magill forceps	1	2
Tongue holding forceps	1	1
Guedel cannula	3	5
Mouth opener	1	1
Scissors cm 14.5	1	1
Endotracheal tubes	-	4



## MEDICATION FIRST AID BAG

- 27132 MEDICATION FIRST AID BAG - empty - 31x22x11 cm
  - 34149 MEDICATION FIRST AID BAG - filled
- First aid bag provided with 2 internal transparent pockets, one external pocket, internal division with 2 zip on both sides, handle and carrying belt.

### STANDARD ACCESSORIES

- London palm sphygmomanometer (32725)
- Yton single head stethoscope (32514)
- Delta Led pen light (25629)
- Fast tourniquet (25728)
- Digital thermometer (25560)
- Sterile adhesive dressing 10x10 cm - box of 6 (34851)
- Liester bandage scissors - 15 cm (34129)
- CPR mask (34218)
- Disinfectant wipes
- 3M Steri strips (34915 - 34916 - 34917 - 34918)
- Emergency cover (34085)



## GIMA RESUSCITATION KITS

- 34181 SPEED 1 RESUSCITATION KIT - UNI cylinder
- 34182 SPEED 2 RESUSCITATION KIT - NF cylinder
- 34183 SPEED 3 RESUSCITATION KIT - without cylinder
- 34180 SPEED EMPTY CASE - with sponge
- 34222 FACEMASK N° 2 - child small



First aid kits for reanimation, very useful for medical and dental rooms, sport clubs, factories, ambulances... Case made of anti-shock plastic. Size: 43 x 37 x 11 cm.

STANDARD ACCESSORIES	SPEED 1	SPEED 2	SPEED 3
Silicone resuscitation bag - autoclavable	•	•	•
Silicone Face mask n° 4	•	•	•
Oxygen cylinder 0.5 l (empty). UNI standard	•	•	•
Oxygen cylinder 0.5 l (empty). NF standard	•	•	•
High pressure manometer	•	•	•
Guedel airways (small + medium + large)	•	•	•
Helicoidal mouthwedge + Tongue holding forceps	•	•	•
Atoxic tubing for connection to oxygen cylinder	•	•	•
Plastic case	•	•	•



34181

## GIMA 3 FIRST AID CASE

- 34151 GIMA 3 - FIRST AID CASE + OXYGEN CYLINDER

Advised for up to 50 people

Size: 32x44.5x15 cm

Meets Italian law D.M. 388 (15.7.03) art. 1 + emergency kit.

Emergency kit includes:

- autoclavable resuscitation with security valve and silicone mask n. 4
- oxygen bottle 0.5 l (empty) with reductor and oxygen distributor - UNI standard
- 3 guedel airways, atoxic tube for connection to oxygen, mouth opener and wall support.

See complete case contents page 384

- 34148 GIMA 3 - EMPTY PLASTIC CASE



34151

34148



## MEDICAL SPORT BAG



- 34135 MEDICAL SPORT BAG  
Special kit designed for first aid in sporting clubs (tennis clubs, swimming pools, gymnasium,.....).

Soft nylon bag has 2 side pockets and zip closure.

Size: 470x240x190 mm  
Weight: 6.5 kg

### STANDARD ACCESSORIES

- |   |   |
|---|---|
| 1 isothermic blanket Gold/Silver 160x210 cm | 1 pack of 20 adhesive plasters 2x7 cm   |
| 1 Disinfectant liquid 250 ml                | 8 adhesive plasters 10x6 cm             |
| 2 adhesive plasters 5 m x 2,5 cm            | 1 sterile TNT bandage 60x40 cm          |
| 2 pairs of sterile gloves                   | 1 sterile TNT bandage 60x80 cm          |
| 2 VENTO mouth to mouth resuscitators        | 6 sterile TNT pads 10x10 cm             |
| 6 sterile gauze pads 18x40 cm               | 5 instant ice packs                     |
| 2 instant ice sprays 150 ml                 | 1 hydrogen peroxide solution            |
| 3 triangular TNT bandages 96x96x136 cm      | 1 elastic net bandage                   |
| 3 Elastic bandages 6 cm                     | 1 haemostatic lacet                     |
| 3 Elastic bandages 8 cm                     | 1 sterile tweezers                      |
| 1 cotton wool pack                          | 5 ammonia towelettes                    |
| 1 pair of LISTER scissors 14,5 cm           | 1 sterile saline solution bottle 250 ml |
| 2 compressive pad bandages 80x100 mm        | 1 gel hands disinfectant 100 ml         |
| 2 compressive pad bandages 100x120 mm       | guidance leaflet 5 languages            |

## FIRST AID FAMILY CASE



Size: 235x190x43 mm

34136



Case in polypropylene

Guidance in:  
GB, FR, IT, ES,  
DE, TR

MADE IN ITALY

- 34136 FAMILY FIRST AID CASE
  - 34450 EMPTY CASE
- Small first aid case suitable for use anywhere and anytime: (at home or office, in the car or boat...).

### STANDARD ACCESSORIES

- |  |                                   |
|--|-----------------------------------|
| 2 sterile gauze pads 18x40 cm          | 3 antiseptic wipes                |
| 1 pair of scissors. 1 plastic tweezers | 1 adhesive dressing 10 x 6 cm     |
| 1 sterile bandage 60x40 cm             | 1 gauze bandage 5 cm              |
| 1 cotton wool pack 5 g                 | 1 adhesive plaster roll 2 cm x 1m |
| 1 pack of 10 adhesive plasters         | 1 pair of protection gloves       |
| 1 tissue pack 10 pcs                   | Guidance Leaflet 6 languages      |

## FIRST AID CASE AND BAG



34184

Advised for offices or workshops of 2 people  
Meets Italian law 388-Art. 2

- 34184 SMALL KIT - plastic case  
Size: 290x215x90 mm - 1.4 kg  
See content of kit at page 334
- 34188 REFILL PACK for 34184-34185-34194
- 34186 EMPTY PLASTIC CASE  
290x215x90 mm
- 34185 MIZAR BAG - nylon  
Size: 250x180x90 mm  
Same contents as 34184 see page 384

34185



# FIRST AID PLASTIC CASES AND METAL CABINETS



34196



34197

- 34196 MEDIUM KIT - plastic case Size: 275x240x123 mm - 2 kg
- 34197 MEDIUM KIT - metal cabinet Size: 370x300x140 mm - 3.8 kg
- 34187 REFILL PACK for code 34196-97
- 34141 EMPTY METAL CABINET 370x300x140 mm



34198



34195



34199

- 34195 LARGE KIT - plastic case 1 Size: 460x345x135 mm - 6.2 kg
- 34198 LARGE KIT - plastic case 2 Size: 395x270x135 mm - 6.2 kg
- 34199 LARGE KIT - metal cabinet Size: 460x300x140 mm - 7.5 kg
- 34189 REFILL PACK for code 34195-34198-34199 without sphygmomanometer
- 34191 EMPTY PLASTIC CASE 1 460x345x135 mm
- 34138 EMPTY PLASTIC CASE 2 395x270x135 mm



- 34143 METAL CABINET  
Supplied with 3 internal metal shelves, removable bottle floor support, 2 small shelves on the door, lock and key. Size 402x582x202 mm - 12.9 kg
- 34145 EMPTY METAL CABINET 402x582x202 mm

STANDARD CASES / CABINETS CONTENT	34194 34184-5	34196 34197	34195 34198-9	34143	34151	SPARES see page
Bags liquid soap		3		3		418
Bags antiseptic wipes		3		3		418-419
Bottle antiseptic solution 125 ml	1	1				-
Bottle antiseptic solution 250 ml				1		419
Bottle antiseptic solution 500 ml			2	3		-
Oxygenated water bottle				1	2	419
Ammonia bag		2		2		-
Pair protective gloves, sterile	2	2	5	5		28-29
Box of 10 assorted plasters	1	1	2		5	410
Box of 100 assorted plasters Plastosan				1	2	410
Box of 100 assorted 7x2 cm Plastosan				1		410
Adhesive plaster roll 2,5 cm x 5 m	1	1	2	2		411
Elastic bandage with clip 4,5 cm x 7 m				1	2	407
Pack of 8 assorted gauze bandages				1		407
Gauze bandage 10 cm x 3,5 m	1	1				407
Tubular net gauze			1	1		403
Pack of sterile compress 10 x 10 cm	3	3	10	10	1	401
Pack of sterile compress 18 x 40 cm	1	3	2	6	10	401
Pack of cotton wool	1	1	1	3	2	403
Mask with face shield			1	1	1	17
Pair of scissors cm 14,5	1	1	1	1	1	374
Sterile forceps	1	1	2	2	1	50
Haemostatic lacet	1	1	3	3	2	76
Sphygmomanometer + Stethoscope			1	1	3	275-310
Sterile blanket 40x60 cm		1	2	2	1	-
Pack of instant ice, single use	1	1	2	2	2	380
Digital thermometer	1		1	1	2	102
Trash bag	1	1	2	5	1	-
Irrigating solution 250 ml		1			1	414
Irrigating solution 500 ml			3	3		-
Triangular blanket 96x96x136 cm		1		4	3	-
Isothermic blanket gold/silver 160x210 cm				1		380
Sterile burn gel sachet 3.5 g				3		380
Compressive Emocontrol bandage				1		407
Pinocchio helicoidal open mouth Vento				1		370
Autodavable resuscitator with facemask N° 4						371
Oxygen bottle 0.5 l empty - UNI standard					1	369
Guedel airways					1	372
Atoxic tube for oxygen					3	374
Mouth opener					1	370

### • 34193 MULTIRED LARGE KIT - plastic case 3

size: 443x338x147 mm  
Made of strong tripolymer plastic which is shiny smooth and easy to clean. Neopren seal fitted to make it dustproof. A wall bracket secures it on any house wall or booth. Internal separators and safe closure with 2 swivel catches. Weight: 3.3 (empty), 8.4 kg (filled).



34193

#### STANDARD ACCESSORIES for 34193

5 pairs of sterile gloves	3 tourniquets
1 safety mask with eye protection visor	2 disposable instant ICE packs
3 sterile saline solutions - 500 ml	2 sanitary bags
2 Iodopovidone disinfectant solutions 10% - 500 ml	1 clinical digital thermometer
10 sterile gauzes in sachets 10x10 cm	1 sphygmomanometer with stethoscope
2 sterile gauzes in sachets 18x40 cm	2 gauze bandages 10 cm x 3.5 m
2 sterile bandages 40x60 cm	1 isothermic blanket gold/silver 160x210 cm
1 pack of cotton	1 triangular TNT bandage 136x96x96 cm
2 sterile tweezers	1 pack of 8 sachet soap/disinfectant
1 pack of net elastic bandage	2 elastic bandages 4 m x 6 cm
2 adhesive plasters 5 m x 2.5 cm	1 sterile compressive bandage 80x100
2 Plastosan 20 assorted dressings	1 Pinocchio mouth opener
1 pair of lister scissors 14.5 cm	2 burn gel sachets 3.5 g

## DOCTOR'S KIT

### STANDARD ACCESSORIES

	34063	34066	34067
Utility bag - blue	•	•	•
Multiuse bag - blue/grey	•	•	•
Aeon A200 non contact infrared thermometer (GB, FR, IT, ES)	•	•	•
Oxy-3 finger oximeter (GB, FR, IT, ES, PT)	•	•	•
Oxy-4 finger oximeter - blue	•	•	•
Kobe palm aneroid sphygmomanometer	•	•	•
Obese cuff + 1 tube bladder	•	•	•
Trad stethoscope - Y black	•	•	•
Classic dual head stetho - Y black	•	•	•
Sigma-C LED otoscope - black - pouch	•	•	•
GIMA glucose monitor kit GB, FR, ES, PT	•	•	•
GIMA glucose monitor kit IT, DE, GR, Arabic	•	•	•
GIMA LED penlight	•	•	•
Dejerine GIMA 2000 - neurological hammer	•	•	•
Fast tourniquet	•	•	•



• 34063 DOCTOR'S KIT 1



• 34066 DOCTOR'S KIT 4A  
• 34067 DOCTOR'S KIT 4B

## MASKS FOR REANIMATION

### CPR MASK



34218



• **34218 CPR MASK - pocket resuscitator**  
The CPR pocket mask is a non-invasive, latex free mask with an integral non-breathing valve and efficient filter to prevent direct mouth contact with the patient's face when providing mouth-to-mouth resuscitation. It can be used on adult, child and infant. Supplied in a compact plastic box with a corrugated tube for an easier use.



34213 Key-holder box

• **34211 VENTO AIRWAYS - Poly-bag**  
• **34213 VENTO AIRWAYS - Key-holder box**  
Disposable mouth to mouth airway with a one way polycarbonate valve and non-toxic pvc protective foil to avoid any direct contact between patient and rescuer. Available in 2 versions: in poly-bag or key-holder box. Instructions in GB, IT, FR, DE.

## SOFT BAG KIT DIN



• **34137 SOFT BAG KIT DIN 13164-2014**  
Contents conform to DIN norms 13164. Size: 260x172x82 mm. Weight: 0.7 kg.

### STANDARD ACCESSORIES

- 1 adhesive plaster roll 5 m x 2.5 cm
- 4 disposable vinyl gloves
- 2 gauze bandages 6 cm x 4 m
- 3 gauze bandages 8 cm x 4 m
- 1 pair of lister scissor 14.5 cm
- 1 isothermic blanket gold/silver 160x210
- 1 sterile compressive pad 60x80 mm
- 2 sterile compressive pads 80x100 mm
- 1 sterile compressive pads 100x120 mm
- 1 sterile TNT burn sheets 60x40 cm
- 1 sterile bandage TNT 60x80 cm
- 3 sterile gauzes 10x10 cm
- 2 alcohol 70% wipes
- 1 pack 14 assorted patches
- 2 triangular bandages TNT 96x96x136 cm
- Instructions (GB, FR, IT, ES, DE, TR)



## SPLINTER REMOVAL KIT



34190

### • 34190 SPLINTER REMOVAL KIT

Includes everything to remove splinters and for first aid medications. In a polypropylene box size 235x190x43 mm:  
1 Eye wash solution 100 ml with an eye glass  
1 magnifying glass, 2 sterile gauze pads 18x40 cm  
1 Professional removal pencil, 1 mirror.  
1 stainless steel tweezers 11.5 cm

### • 34192 PROFESSIONAL REMOVAL PENCIL

Small metallic splinters eye tool remover. On one side a magnetic point to remove any metallic splinter avoiding any risk for the eye. On the other side an antiabrasive nylon loop for non metallic splinters.

385

## EYE WASH SYSTEMS

### • 34889 DROP - eye wash station

Thermo-formed wall kit with all necessary items for efficient first emergency eye wash:  
- 2 sterile saline solutions of 500 ml  
- 2 integrated eye cups and one mirror  
- screw and plug to be wall-mounted.

### • 34887 EYE WASH SOLUTION 250 ml

- sterile - spare - box of 18

### • 34888 EYE WASH SOLUTION 500 ml - sterile - spare

Disposable, 0.9% sodium chloride sterile solution for emergency eye wash. Simple to use. The bottle is ready to use and fitted with a cap.

34887



34889



MADE IN ITALY

# CAPNOGRAPH AND OXIMETER

## 33698 CAPNOGRAPH AND OXIMETER PC-900B

Innovative and handheld capnograph and oximeter ideal for monitoring the most severe conditions of intubated or not intubated patients. It provides reliable SpO<sub>2</sub> and pulse rate measurements thanks to its unique MoveOxy™ technology specially conceived for SpO<sub>2</sub>. Accurate monitoring even in weak pulse signals condition and reliable monitoring in movement. Display of graphical trends and plethysmographic waveform.

- 3.5" TFT display showing EtCO<sub>2</sub>, RR and SpO<sub>2</sub>, PR
  - lung pressure and temperature compensation (BTPS compensation)
  - graphic trend storage up to 24 hours for all parameters
  - USB cable to transfer data on PC
  - wireless module to connect to Bluetooth printer
- Dimension: 70x160x40 mm. Weight: 600 g.  
Internal languages: GB, IT, ES, NL, DE, FR.

- 34351 ADULT SpO<sub>2</sub> RUBBER PROBE - reusable
- 34345 ADULT SpO<sub>2</sub> CLIP PROBE - reusable - spare
- 34347 PEDIATRIC SpO<sub>2</sub> PROBE - reusable
- 34349 NEONATAL SpO<sub>2</sub> Y PROBE - reusable
- 33699 WATER FILTER - disposable
- 33700 SAMPLING LINE - disposable
- 33701 AIRWAY ADAPTER - disposable
- 33694 CO<sub>2</sub> SAMPLING NASAL CANNULAS



PC software for data review and analysis  
Software (GB only) can be freely downloaded



### STANDARD ACCESSORIES

- 2 water filters
- 2 sampling lines
- 2 airway adaptors
- USB data cable
- Nasal CO<sub>2</sub> sampling cannula
- Silicone protective case, carrying bag, support base
- SpO<sub>2</sub> probe
- Manual GB, IT

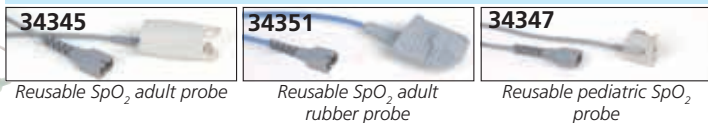

### TECHNICAL SPECIFICATIONS

EtCO <sub>2</sub> EtCO <sub>2</sub> /CO <sub>2</sub> range:	0-150 mmHg (0-20 kPa, or 0-20% (V/V))	SpO <sub>2</sub> Oximetry saturation range:	0-100% ±2% when 70-100%, ±3% when 50-69%
Accuracy:	when mmHg 0-40 ±2 mmHg >41-70 ±5% >71-100 ±8% >101-150 ±10%	Pulse rate Range:	30-250 bpm ±2 bpm or ±2% (reading) when 30-250 bpm
Update:	Every breath, 10, 20 or 30 sec selectable	Power supply AC input consumption:	100-250 V, 50-60 Hz, 5 W
Respiration rate Range:	3-150 breaths/min ±1% (reading) or ±1 times/min	Battery:	Built-in rechargeable lithium battery - 3.6 V, 3000 mAh
Flux:	50-250 cc/min selectable	Working time:	10 hours

# OXY-200 DESKTOP PULSE OXIMETER

Continuous working time: more than 1 hour  
Audible and visible alarm for over-limit and low battery.  
Upper and lower alarm limit can be set.



35213  
Screen brightness, volume and display mode can be adjusted  
320x240 TFT screen and LCD  
Menu operation easy to use

## 35213 OXY-200 DESKTOP PULSE OXIMETER with monitor and battery

Portable oximeter displays SpO<sub>2</sub>, PR, bar graph, PI, pulse waveform and battery power. Multiuser data storage and review. Stored data can be uploaded to PC in real time. Finger adult probe, battery and software for PC download are included. Multilingual box and manual (GB, FR, IT, ES).

- 35153 SpO<sub>2</sub> FINGER-PROBE - adult or child over 40 kg - spare
- 35215 PEDIATRIC PROBE 10-40 kg - reusable
- 35216 NEONATAL PROBE 3-10 kg - reusable
- 35109 ADULT NEONATAL PROBE - disposable - needs 35217
- 35104 EXTENSION CABLE necessary for 35107, 35109

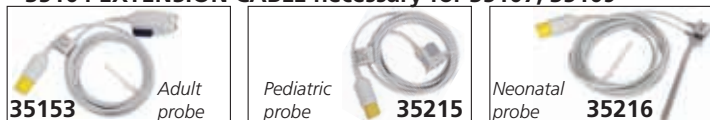

35153 Adult probe	35215 Pediatric probe	35216 Neonatal probe
----------------------	--------------------------	-------------------------

**TECHNICAL SPECIFICATIONS**

Battery: rechargeable lithium battery, charger cable 100-240 V, 50/60 Hz  
SpO<sub>2</sub> measuring range: 0-100% ±2% (between 70-100%)  
Pulse rate: 30-250 bpm ±2 bpm or ±2% (select larger)  
PI measuring range: 0-20% ±1% (between 1%-20%)  
Size: 269x222x79 mm - Weight: 1 kg

Resolution: 1%  
Resolution: 0.1%

\*Suitable for adult over 40 kg (finger) or neonate less than 3 kg (foot)

# CAPNO CUBE CAPNOGRAPH

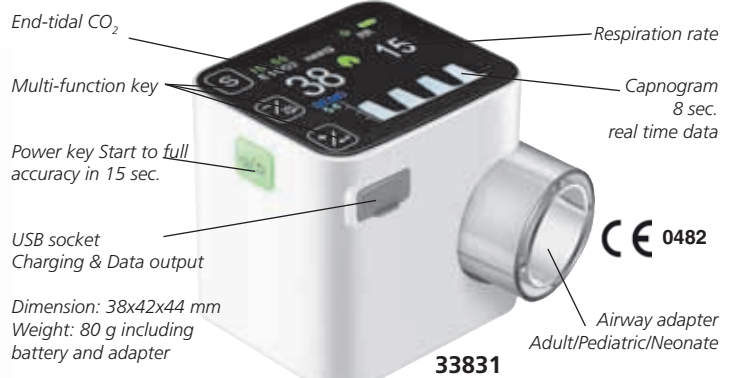

End-tidal CO<sub>2</sub>  
Respiration rate  
Capnogram 8 sec. real time data  
Multi-function key  
Power key Start to full accuracy in 15 sec.  
USB socket Charging & Data output  
Dimension: 38x42x44 mm  
Weight: 80 g including battery and adapter  
Airway adapter Adult/Pediatric/Neonate  
33831  
CE 0482

## 33831 POCKET CAPNO CUBE CAPNOGRAPH (MAINSTREAM)

Innovative capnograph designed for monitoring the vital physiological signs of patients from newborn to adult. - sensitive and accurate monitoring of EtCO<sub>2</sub>, Respiration Rate, real-time Capnogram within 15 seconds - suitable for pre-hospital first aid, incubator, anesthesiology, respiration, sleeping monitoring and intubated monitoring - 24 hours memory with data management software - large numeric display visible from 5 meters Supplied with adult/pediatric adaptor, neonatal adaptor, silicone protection, USB cable, AC adapter, CD software and manual (GB, IT).

- 33832 ADULT/PEDIATRIC AIRWAY ADAPTOR
- 33833 NEONATAL AIRWAY ADAPTOR

**TECHNICAL SPECIFICATIONS**

EtCO <sub>2</sub> Method: Non-dispersive Infrared Spectroscopy Range: 0-150 mmHg or 0-20 kPa Accuracy: ± 2 mmHg, range from 0-40 mmHg ± 5%, range from 41-70 mmHg ± 8%, range from 71-100 mmHg	Sensor: Adapter for intubated patient InsCO <sub>2</sub> Range: 3 - 50 mmHg Other Airway Adapter dead space: 5 ml (adult/pediatric), 1 ml (neonate) AC input: 100-240 V, 50/60 Hz - 5 W Battery: Lithium 3.7 V, 1400 mAh Charging time: 4 hours Operating time: 6 hours Firmware software: GB, FR, IT, ES, DE, NL Norms: IEC 60601-1/CSA 601-1/UL2601-1 Protection: Type BF - Class II, IP 33
Update time: Every breath Warm up time: < 15 seconds Memory: 24 hours with trend and numeric	
<b>Respiration Rate</b> Range: 3-150 rpm ± 1% or ± 1 rpm Memory: 24 hours with trend and numeric	

# OXY-50 HANDHELD PULSE OXIMETER



Plethysmogram waveform

ALSO AVAILABLE WITH BLUETOOTH



35100

Supplied with one adult probe, 2 AA batteries, USB cable, PC software (GB, FR, IT, ES, DE, RU, PL) and user manual (GB, FR, IT, ES)

- 35100 OXY-50 PULSE OXIMETER - with software
- 35103 OXY-50 BLUETOOTH PULSE OXIMETER - with software

Pocket fingertip pulse oximeter with colour display for routine check and continuous monitoring use.

- display: 1.77" colour TFT
- resolution: 160x128
- alarm sound, pulse tone
- record: data can be recorded up to 24 hours
- alarm: adjustable high and low limits
- PC software for transferring real time data

GIMA code	ACCESSORIES OXY-50
35105	Adult probe >40 kg - reusable - spare
35106	Pediatric probe 10-40 kg - reusable
35107	Neonatal probe 3-10 kg - reusable
35109	Adult and neonatal probe* - disposable - 70 cm cable
35108	Extension cable 2 m necessary for 35107, 35109

\*Suitable for adult over 40 kg (finger) or neonate less than 3 kg (foot)

### TECHNICAL SPECIFICATIONS

<b>Display mode (TFT display)</b>	<b>SpO<sub>2</sub></b>
SpO <sub>2</sub> : 2 digits	Measuring range: 0~100%, (resolution 1%)
Pulse rate (PR): 2 digits	Accuracy: 70~100%: ±2%
Pulse intensity: bar-graph	Average value: Calculate the average value every 4 measure value
<b>Pulse rate</b>	Deviation between average value and true value does not exceed 1%
Measuring range: 30 ~ 250bpm	<b>Power supply:</b>
Resolution: 1 bpm	<b>Battery:</b> DC 3V, < 100 MA
Accuracy: ±2bpm or ±2%	<b>Oxymeter probe:</b> wavelength: 660 - 905 nm
Average pulse rate: Moving calculate the average pulse rate every 4 cardio-beat's cycle. Deviation between average value and true value does not exceed 1%	<b>Dimension:</b> 110(L)x60(W)x23(H) mm
<b>Pulse intensity range:</b> Continuous bar-graph display, the higher display indicates the stronger pulse	<b>Weight:</b> about 120g (with dry battery 2AA)
	<b>Safe type:</b> BF Type



35106 Pediatric probe - reusable



35107 Neonatal probe - reusable



35108 Extension cable (necessary for 35107, 35109)



35109 Adult, neonatal probe - disposable

# OXY-100 HAND-HELD PULSE OXIMETER

• 34342 OXY-100 PULSE OXIMETER  
Compact pulse oximeter for hospital and rescue applications to monitor SpO<sub>2</sub> pulse rate, pulse strength and perfusion index (PI). SpO<sub>2</sub> can be displayed in numbers with bar-graph of pulse as well as full display of plethysmogram. Includes adult SpO<sub>2</sub> sensor and extension cable.

**Features:**

- high accuracy and repeatability
- visual and audible alarm, with adjustable limits
- 384-hours data storage and review (recording every 1/2/4/8 sec.)

- automatic power-off  
Manual: GB, FR, IT, ES, PT.

- 34344 SOFTWARE
  - This software allows to download and store all measurements on a PC through USB port.
  - 34345 ADULT SpO<sub>2</sub> CLIP PROBE - reusable - spare
  - 34351 ADULT SpO<sub>2</sub> RUBBER PROBE - reusable
  - 34347 PEDIATRIC SpO<sub>2</sub> PROBE - reusable
  - 34348 EXTENSION CABLE - spare for 34345-34347-34349-34351 - 1 m
  - 34349 NEONATAL SpO<sub>2</sub> Y-TYPE PROBE - reusable
- All probes with cable 0.9 m

3 ways switchable display to show: numbers, number and waveform, waveform

TECHNICAL SPECIFICATIONS	
<b>Operating mode:</b> continuous operation	
<b>Display Mode:</b> Color dot-matrix LCD	
<b>SpO<sub>2</sub></b>	
Measuring range: 35~100%	
Accuracy: Not greater than 3% for SpO <sub>2</sub> range from 70% to 100%	
<b>Transducer:</b> dual-wavelength LED sensor with red light: 663 nm, Infrared light: 890 nm	
<b>Pulse Rate</b>	
Measuring range: 30~240 bpm	
Accuracy: ±2 bpm or ±2% (whichever is greater)	
Over-limit setting range: 25~250 bpm	
Default setting limit: High 120 bpm, Low 50 bpm	
Perfusion Index Display Range: 0.2%~20%	
<b>Range alarm setting:</b> SpO <sub>2</sub> lower limit: 50% SpO <sub>2</sub> upper limit: 99% pulse rate upper limit: 100-240 bpm pulse rate lower limit: 30-99 bpm	
Data Update 8 beats moving average for both SpO <sub>2</sub> and pulse rate readings.	
<b>Power Supply:</b> d.c. 4.5V(3 AA alkaline batteries)	
<b>Dimensions:</b> 145x74x29 mm - 210g (including batteries)	
<b>Classification</b>	
Type of protection against electric shock: Type BF applied parts.	
Degree of protection against liquids: IP22.	
Class B	

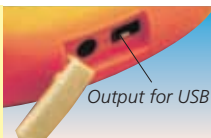

Output for USB

High resolution LCD display, backlight to display SpO<sub>2</sub>, PR, Pulse Bar, PI, and Plethysmogram



34342



Battery status display

Portable and lightweight

CE 0476



34345 Reusable SpO<sub>2</sub> adult probe



34351 Reusable SpO<sub>2</sub> adult rubber probe



34347 Reusable pediatric SpO<sub>2</sub> probe



34349 Reusable neonatal SpO<sub>2</sub> Y probe

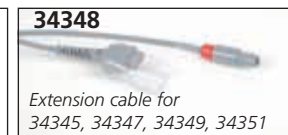

34348 Extension cable for 34345, 34347, 34349, 34351





# MINDRAY PM-60 PULSE OXIMETER



Size: 55x120x30 mm  
Weight: 300 g with battery

- **35060 MINDRAY PM-60 PULSE OXIMETER**  
Lightweight device for **spot-check and continuous monitoring of SpO<sub>2</sub> and pulse rate.**  
**Spot Check Mode**
  - auto-standby and power off during the idle status
  - auto-increase the patients IDs
  - non-alarm setting for "sensor off" occasion
- 1-99 IDs for maximum 4,000 sets of measurements
- Continuous monitoring mode**
  - regular alarm handling
  - enable to input patient ID manually
  - view SpO<sub>2</sub> waveform for maximum 96 hours trend
- Other features**
  - suitable for adult and pediatric patients
  - high resolution 2.4" colour LCD display
  - adjustable visual and audible alarms
  - real-time data transfer by infrared technology
  - choose between Li-ion or AA alkaline batteries
- Supplied with adult reusable sensor
- **35062 PROTECTIVE COVER - light blue**
- **35063 DATA MANAGEMENT KIT**
- **35064 BATTERY CHARGING KIT (EU)**
- Li-ion battery + charge stand + power cable**
- **35065 PEDIATRIC REUSABLE SENSOR**

### TECHNICAL SPECIFICATIONS

<b>SpO<sub>2</sub></b>	Measurement range: 0~100% ±2% (70~100%)
Resolution:	1%
Averaging time:	7 s (sensitivity set HIGH) 9 s (sensitivity set MED) 11 s (sensitivity set LOW)
<b>Pulse rate</b>	Range: 18~300 bpm (±3 bpm non-motion) (±5 bpm motion)
Resolution:	1 bpm
Averaging time:	same as SpO <sub>2</sub>
<b>Device</b>	Display: 2.4" colour TFT Resolution: 320x240
Trace:	Selectable: standard or waveform screen
Indicator:	1 plethysmogram waveform alarm indicator light, power indicator light, pulse tone, alarm sound, button tones
Interface:	dual-purpose socket for connecting SpO <sub>2</sub> sensor and communication cable
IR interface:	infrared link allows downloading realtime patient data to computer
DC power:	input voltage 5V DC Power 1.2A
Battery:	interface: charger stand for Li-ion battery Li-ion battery 24 hours continuous working 3xAA batteries 36 hours continuous working
Trend memory:	Monitoring mode: Resolution: 2s Maximum time: 96 h
Alarm:	Spot-check mode: Review of up to 4,000 data Measure up to 99 patients user adjustable high and low limits 3-level audible and visual alarm
Protection:	Class II with internal electric power supply Degree of protection: BF (defibrillation proof), IPX 2 (liquid)

# PALM SAT® 2500A NONIN PULSE OXIMETER

- **35086 PALM SAT® 2500A PULSE OXIMETER with rubber reusable adult probe and alarm.**  
A compact versatile and reliable pulse oximeter designed and tested to exceed all durability requirements.
- Pure Sat® technology offers accuracy & speed in getting a reading, even with varying skin pigmentations or polish and is able to monitor, with declared accuracy in challenging conditions, such as motion & low perfusion, for all patients
- it is tested to assure performance in challenging conditions, such as drop and liquid ingress (IPX 2). Granted by US Army/Air Force Aeromedical certification
- It also features: audible and visual alarms, 72 hours memory, long battery life (60 hours) or rechargeable battery for 40 hours.

### TECHNICAL SPECIFICATIONS

SpO <sub>2</sub> range:	0% to 100% ±2 (70-100% without movement)
Pulse rate range:	18 to 321 bpm ±3 (18-300% without movement)
Power:	4AA alkaline batteries 1.5 V (for 60 hours use) optional NiMH rechargeable battery (for 40 hours use)

### ACCESSORIES SAT 2500

GIMA code	ACCESSORIES SAT 2500
35087	Adult reusable rubber probe (12.5-25.5 mm) - 1 m cable
35088	Pediatric reusable rubber probe (10-19 mm) - 1 m cable
35089	Charger stand with NiMH battery pack, plug kit
35082	NVISION software for data management (GB)
35083	Adaptor for USB - PC connection

Bright LED display of SpO<sub>2</sub> and pulse rate

Audible and visible alarms

Easy 2 button operation

Three-coloured signal quality indicator

Blinking alarm silence indicator. Low battery indicator

Rugged rubberized case with IPX 2 level of liquid ingress protection

MADE IN USA

CE 0123  
FDA

35086 + 35089

Size: 7x13.8x3.2 cm  
Weight: 213 g

Supplied with multilingual cd-rom manual: GB, FR, IT, DE, ES, PT, GR, NL, PL, NO, FI, DK, SE. **35086**

# OXY 110 PULSE-OXIMETER FOR NEONATES, CHILDREN AND ADULTS

- **34341 OXY 110 PULSE OXIMETER**  
- large 3.5 inch auto rotation TFT display for SpO<sub>2</sub>, PI, Plethysmogram, PR and temperature
- patented MoveOxy™ SpO<sub>2</sub> technology with artifact removal and anti-motion performance
- various choice of SpO<sub>2</sub> probes for adult, pediatric and neonate
- built-in lithium battery up to 20 hours continuous monitoring
- adjustable alarm limit, pitch tone level, key tone and brightness
- up to 1,000 hours SpO<sub>2</sub> data storage
- upgradeable to infrared ear temperature
- Supplied with adult clip probe, charging base, USB cable.

### TECHNICAL SPECIFICATIONS

Technique:	dual wavelength LED
SpO <sub>2</sub> range:	35 to 100% ±3%
Pulse rate range:	30 to 250 bpm ±2%
Perfusion index (PI) range:	0.2 to 20%
Display:	3.5" TFT display
Data storage:	up to 1,000 hours
Measuring mode:	continuous or spot check
Power supply:	lithium battery
Charging:	charging stand or USB cable
Dimension:	158x73x25 mm
Weight:	240 g
Data upload:	USB cable or wireless

GIMA code	ACCESSORIES OXY 110	
35170	Ear infrared thermometer	
35171	Ear probe cover for 35170 - box of 500	
34344	Software for download and store	
New*	Old**	Reusable probes with cable 0.9m
35317	34345	Adult SpO <sub>2</sub> clip probe - spare
35314	34351	Adult SpO <sub>2</sub> rubber probe
35316	34347	Pediatric SpO <sub>2</sub> probe
35315	34349	Neonatal SpO <sub>2</sub> Y-Type probe

34341

\*Since OXY 110 SIN XCU017RH009941 (new) \*\*Till OXY 110 SIN XCU052QF005021 (old)

34341

Multilingual box and manual: GB, FR, IT, ES

## OXY 1 AND OXY 2 PULSE-OXIMETERS

BOX AND MANUAL  
IN 18 LANGUAGES

- 35069 OXY 1 PULSE OXIMETER IT, HR, FI, LV, BG, Arabic
- 35070 OXY 1 PULSE OXIMETER GB, PT, GR, DK, NL, RO
- 35071 OXY 1 PULSE OXIMETER FR, ES, DE, PL, CZ, SE
- 35072 OXY 2 PULSE OXIMETER GB, FR, IT, ES, PT, GR

Pulse Oximeter for measuring pulse oxygen saturation and pulse rate through finger. Suitable for domiciliar and professional use in family or hospital.

It can be used before or after sports, but not recommended throughout.

- SpO<sub>2</sub> and pulse rate value display, bar graph display
- low-voltage indicator
- automatic power off within 5 seconds.



35069  
35070  
35071



35072  
Weight: 50g  
(including two batteries)

TECHNICAL SPECIFICATIONS	
Display mode:	LED display
SpO <sub>2</sub>	range: 0-100%, (resolution 1%) accuracy: 70-100%: ±2%, below 70% unspecified
PR	range: 30-250 bpm, (resolution 1 bpm) accuracy: ±2 bpm or ±2% (select larger)
Measurement in weak	filling condition: SpO <sub>2</sub> and pulse rate can be shown correctly when pulse-filling ratio is 0.4%. SpO <sub>2</sub> error is ±4%, pulse rate error is ±2 bpm or ±2% (select larger)
Power consumption:	less than 25 mA - Voltage: DC 2.6 V - 3.6 V
Battery working hour:	two batteries can work continuously for 24 hours
Safety Type:	interior battery, BF Type
Dimension:	57x31xh 32 mm (Oxy 1) 60x30.5xh 32.5 mm (Oxy 2)

MULTILINGUAL BOX AND MANUAL



35069

IT, HR, FI, LV, BG, Arabic



35070

GB, PT, GR, DK, NL, RO



35071

FR, ES, DE, PL, CZ, SE



35072

GB, FR, IT, ES, PT, GR

## OXY-3 OXIMETER

DUAL COLOUR  
TFT DISPLAY



Supplied in blister with batteries and lanyard



35090

CE 0476  
FDA

- 35090 OXY-3 OXIMETER GB, FR, IT, ES, PT - blister
  - 35074 OXY-3 OXIMETER IT, DE, SE, HU, RO - blister
- Easy to use pocket device, measures oxygen level and pulse rate. Main features:

- simple operation, small & lightweight design, portable
- display SpO<sub>2</sub>, SpO<sub>2</sub> waveform, PR, Pulse bar
- low power consumption
- 2 AAA alkaline batteries included
- low battery indication, auto power off
- accommodates widest range of finger sizes from pediatric to adult
- soft silicone padding, strong slip
- resistant clip, non-invasive, no pricking
- 4 direction display

- 35075 SILICONE COVER - light blue
- 35076 CORDURA BAG with belt loop - blue

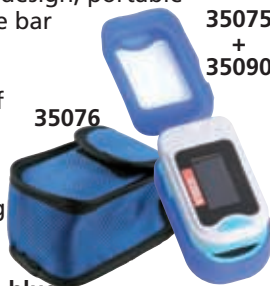

35075  
+  
35090

## OXY-0 PEDIATRIC OXIMETER

CE 0123



35056

35057

- 35056 OXY-0 PEDIATRIC OXYMETER -tiger - GB, FR, IT, PT, SE, RO
  - 35057 OXY-0 PEDIATRIC OXYMETER -crocodile - GB, IT, ES, DE, PL, GR
- Intended for measuring oxygen saturation (SpO<sub>2</sub>) and pulse rate of children at home, hospital, sports healthcare....

LCD coloured display shows SpO<sub>2</sub> value, Pulse Rate value, Pulse Rate waveform and bar graph. 4 direction display with adjustable display mode and brightness. Automatic power off function within 5 seconds. It includes one hanging rope, two AAA batteries and user manual.

TECHNICAL SPECIFICATIONS	
Display:	LCD coloured display
SpO <sub>2</sub> :	range: 0% ~ 100%, (resolution is 1%) accuracy: 70% ~ 100%: ±2%, < 70% unspecified
Pulse Rate	range: 30 bpm ~ 250 bpm (resolution 1 bpm) accuracy: ±2 bpm or ±2% select larger
Power:	2xAAA 1.5 V alkaline batteries
Battery working hour:	two batteries can work continuously for 20 hours
Dimension - weight:	59x36xh 35 mm - 50g (including batteries)

## OXY-PED PEDIATRIC OXIMETER

- 34266 OXY-PED PEDIATRIC OXIMETER
- Same as OXY-6 (see page 390) but suitable for pediatric use.

Input shaped to fit children's fingers thickness 8-16 mm.

Visual and audible alarms.

Supplied with two rechargeable batteries, USB charger and multilingual manual: GB, FR, IT, ES, PT, DE, GR, Arabic

- 34270 RECHARGEABLE BATTERY - spare



34266

4 direction OLED  
colour display

Oxy-ped  
with standard  
accessories



34266

	TECHNICAL SPECIFICATIONS		
	RANGE	ACCURACY	RESOLUTION
Pulse rate:	30-240 bpm	± 2 bpm (2%)	1bpm
SpO <sub>2</sub> :	35%-99%	± 2% (75-99%) ± 3% (50-75%)	1%
Perfusion index:	0-20%	± 0.1% (0.2-2%) ± 0.2% (2-10%)	0.1%
Alarm:	SpO <sub>2</sub> : low limit 90% Pulse rate: low: < 50 bpm - high > 120 bpm		
Power:	3.6V rechargeable batteries Norms: IEC 60601-1-2 Class II		

# OXY-5 AND OXY-6 PROFESSIONAL OXIMETERS



CE 0476

BACKLIT DISPLAY

34282



CE 0476

OLED COLOUR DISPLAY

34285



34285

- 34282 OXY-5 FINGERTIP OXIMETER
- 34265 OXY-5 PEDIATRIC FINGERTIP OXIMETER
- 34285 OXY-6 COLOUR FINGERTIP OXIMETER

To monitor pulse oxygen saturation and pulse rate through patient's finger (10-22 mm finger thickness for 34282, 34285 - 8-16 mm finger thickness for 34265) in medical environments. Main features:

- SpO<sub>2</sub> and pulse rate measurement
- bargraph of pulse rate
- perfusion index display. P.I. is a numerical value that indicates the blood perfusion condition at the sensor site. It is a relative value that varies from patient to patient and from measuring site
- high accuracy and repeatability: products are manufactured by GIMA (in P.R.C. facilities) under strong quality controls guaranteed by Italian notified body (CE 0476 CERMET)
- accuracy from the first reading in few seconds thanks to a unique noise rejection capability feature
- extra stability against motion during measurement (finger bending, Parkinson's disease, hand movement, button pressing)

- audible and visible alarms
- automatic power on and power off when finger is out
- low voltage alarm display
- 8 or 9 language manual (GB, FR, IT, ES, DE GR, PT, PL\*, Arabic)
- 50 hours working time with full batteries (30 hours for oxy-6)
- supplied in plastic case with batteries and pouch
- 4 direction adjustable display (Oxy-6 only)

• 35076 CORDURA BAG with belt loop - blue \*34265, 34282 only

TECHNICAL SPECIFICATIONS			
	RANGE	ACCURACY	RESOLUTION
Pulse rate:	30-240 bpm	± 2 bpm (2%)	1bpm
SpO <sub>2</sub> :	35%-99%	± 2% (75-99%) ± 3% (50-75%)	1%
Perfusion Index:	0-20%	± 0.1% (0,2-2%) ± 0.2% (2-10%)	0.1%
Alarm:	SpO <sub>2</sub> : low limit 90% Pulse rate: low: < 50 bpm - high > 120 bpm		
Power:	1.5V (AAA size) alkaline battery x 2		
Norms:	IEC 60601-1-2 Class II		
LCD Display:	oxygen saturation, pulse rate, low battery indicator		
Size - weight:	6.6x3.6x3.3 cm - 60 g including batteries		

# ONYX® VANTAGE 9590



Large bright LED Display  
SpO<sub>2</sub> and pulse rate can be read from any angle, day or night



Made in USA

Lead (Pb) free and latex free CE 0123



- 35085 NONIN ONYX® VANTAGE 9590 PULSE OXIMETER - black
- 35084 NONIN ONYX® VANTAGE 9590 PULSE OXIMETER - blue

The only finger pulse oximeters with scientifically proven accuracy in motion and low perfusion. Tested for use on fingers, thumbs, or toes.

- **Accurate** - Scientifically proven performance in the widest range of patient populations and settings
  - **Durable** - Protects against dropping and water spills; allows for thousands of uses in any environments and exceed IP32 water ingress testing
  - **Efficient** - Up to 6000 spot checks or 36 hours of continual operation on two AAA batteries
  - **Safe** - Built in the USA with lead-free and latex-free construction
  - **Versatile** - suitable for pediatric to larger adult patients. Wide range of digit thicknesses from 8 mm to 25.4 mm
  - **Warranted** - Industry-leading 4-year warranty
  - **Cost Effective** - Proven accuracy, quality and durability make the Onyx Vantage a smart purchase for the long term
- Multilingual CD manual: GB, FR, IT, DE, ES, PT, GR, NL, PL, NO, FI, DK, SE.

TECHNICAL SPECIFICATIONS

Pulse rate range:	18-321 bpm	±3 digit (20-250 bpm)
SpO <sub>2</sub> range:	0-100%	±2 digit (70-100%)
Low perfusion SpO <sub>2</sub> :	70-100%	±2 digit
Low perfusion pulse rate:	40-240 bpm	±3 digit

# OXY-4 COLOUR OXIMETER

Size: 66x36x33 mm



DUAL COLOUR OLED DISPLAY

35092

35091

CE 0123

- 35091 OXY-4 OXIMETER - blue
- 35092 OXY-4 OXIMETER - orange
- 35093 OXY-4 OXIMETER - other colour (minimum 100 pieces)

Select colour with order **1 2 3 4 5 6**

Fingertip pulse oxymeter to monitor pulse oxygen saturation, pulse rate, and perfusion index.

- it is light, small in size and easy to take
- accurately measures SpO<sub>2</sub> value and pulse rate value
- dual-colour display of SpO<sub>2</sub>, PR, PI, Plethysmogram and pulse bar
- measuring range, SpO<sub>2</sub> 35 - 99%, Pulse rate 30 - 240 bpm
- innovative 4 directions display
- automatic power On/Off
- more than 30 hours continuous working with 2AAA alkaline batteries
- audible and visible alarm function
- battery voltage indication, low battery voltage alarm
- prevention against water ingress, drop resistant
- manual in 8 languages: GB, FR, IT, DE, ES, PT, GR, PL

• 35076 CORDURA BAG with belt loop - blue

## OXY 9 OXIMETER - WIRELESS



35078

CE 0123

Dimension: 58x32xh 34 mm  
Weight: about 52g (including 2xAAA batteries)

### • 35078 OXY-9 MULTIFUNCTION OXIMETER - WIRELESS

Portable pulse oximeter adopting advanced technology. It checks SpO<sub>2</sub> and PR value through the finger, for oxygen saturation measurement. It also works as pedometer and calories calculator. Applicable for several uses within different environments (medical institution, family, fitness clubs...).

- display of SpO<sub>2</sub> value, PR value and bar graph
  - calories, steps and time display
  - automatic patient oriented display
  - sync clock function
  - data stored can be uploaded to PHMS App by Bluetooth, App will upload the data to Cloud platform for analyzing
  - height, weight, target calorie and pedometer sensitivity can be set by the server.
  - automatic storage for SpO<sub>2</sub> and PR value
  - low battery indication
- Supplied with rope, white cover, 2xAAA batteries, multilingual manual GB, FR, IT, ES, PT, DE.

#### TECHNICAL SPECIFICATIONS

SpO <sub>2</sub>	range: 0~100% accuracy: 70~100% ± 2%	Resolution: 1%	SpO <sub>2</sub> : 1%
PR	range: 30-250 bpm accuracy: ± 2 bpm or ± 2%, whichever is greater	Pedometer	PR: 1bpm range: 0-65535 steps resolution: one step
Measurement in Weak Filling Condition:	SpO <sub>2</sub> and PR can be shown correctly when pulse-filling ratio is 0.4%. SpO <sub>2</sub> error is ±4, PR error is ±2%, whichever is greater.		
		Memory function:	record 1000 groups of SpO <sub>2</sub> data, 224-day pedometer data
		Safety classification:	type BF applied part

## OXY 10 OXIMETER - WIRELESS

### • 35095 OXY-10 MULTIFUNCTION OXIMETER - WIRELESS

Professional oximeter to monitor pulse oxygen saturation and pulse rate through patient's finger (adult, child, neonate).

- wireless Bluetooth technology for transmission to PC Windows (XP and Seven) and Android (need APP).
- Software for data management
- 4 optional external SpO<sub>2</sub> probes for pediatric and neonatal use
- large true colour OLED display
- SpO<sub>2</sub>, PR, Pulse bar, P.I. and plethysmogram
- accuracy from the first reading in a few seconds
- extra stability against motion during measurement
- adjustable audible and visible alarms: high and low limits
- 4 directions automatic patient oriented display
- 9 languages manual (GB, FR, IT, DE, ES, GR, PT, PL, Arabic)
- Communication protocols on request.

Supplied in nylon bag with batteries.

- 35096 PEDIATRIC CLIP PROBE - reusable
- 35097 PEDIATRIC RUBBER PROBE - reusable
- 35099 NEONATAL Y-PROBE - reusable



OLED COLOUR DISPLAY

CE 0476

35095

#### EXTERNAL PEDIATRIC AND NEONATAL PROBES - optional

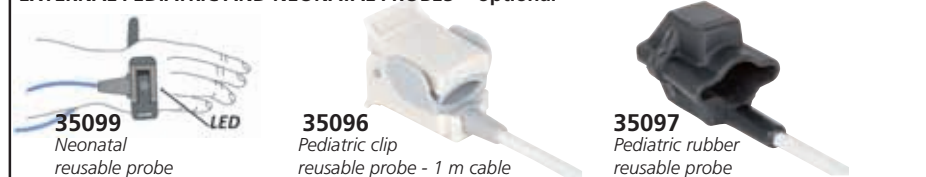

35099

Neonatal reusable probe

35096

Pediatric clip reusable probe - 1 m cable

35097

Pediatric rubber reusable probe

#### TECHNICAL SPECIFICATIONS

	RANGE	ACCURACY
Pulse rate:	30-240 bpm	± 2 bpm or 2%
SpO <sub>2</sub> :	70%-100%	± 3%
Perfusion index (PI):	0.2-20%	
Alarm:	SpO <sub>2</sub> : 85-99%	
	Pulse rate: high 100-240 bpm, low 30-60 bpm	
Power:	2xLR03 (AAA) Alkaline batteries 3.0 VDC	
Size:	60x33x30 mm	Weight: 35 g

## iHEALTH AIR PULSE OXIMETER - LED DISPLAY

iHealth MyVitals App allows to manage all your iHealth devices and track relations among parameters. See page 292



### • 23525 iHEALTH AIR - WIRELESS PULSE OXIMETER

Lightweight and reliable Pulse Oximeter to spot-check blood oxygen saturation (SpO<sub>2</sub>), pulse rate (bpm) and volume of blood flow (perfusion index).

- measures and records SpO<sub>2</sub> and pulse rate from your mobile device
- easy-to-read LED screen displays SpO<sub>2</sub>, pulse rate and perfusion index
- connects wirelessly via Bluetooth 4.0
- free iHealth app and cloud service include personalized health tools
- Automatic shut down after 8 seconds
- Size: 62x33x28 mm
- Supplied with lanyard and USB charging cable.



#### TECHNICAL SPECIFICATIONS

Classification:	Internally powered, type BF
Power:	Battery, 3.7 V Li-ion, 300 mAh
SpO <sub>2</sub> Measuring Range:	70-99%, ±2%
Pulse Rate Measuring Range:	30-250 bpm, ±2 bpm or ±2% larger one

## O2RING™ PULSE OXIMETER - CONTINUOUS MONITORING

- 35066 O2RING™ CONTINUOUS MONITORING OXIMETER - KID
- 35067 O2RING™ CONTINUOUS MONITORING OXIMETER - ADULT
- 35068 O2RING™ WIRELESS REMOTE CONTINUOUS MONITORING OXIMETER - ADULT

Innovative, wearable, adaptable and reliable pulse oximeter, designed to monitor heart rate, oxygen saturation and perfusion index.

### Monitor oxygen level anytime, anywhere

- comfortable wearing experience
- track and record oxygen level and heart rate
- smart vibration triggered by low SpO<sub>2</sub>
- built-in rechargeable battery for overnight use
- sync real-time data with App via Bluetooth
- support remote monitoring by wireless module (35068)

### Track and record oxygen level overnight

During your sleep, once a low oxygen level or an abnormal heart rate is detected, O2Ring vibrates immediately to warn the user. After syncing the recording data to App, detailed analysis and trends of oxygen level and heart rate can be reviewed.

Supplied with data/charging cable, user manual (GB, FR, IT, ES, DE).

PC software can be downloaded online.

### Wireless module - (only 35068)

The wireless module is integrated with Bluetooth and Wifi for reliable real-time and remote monitoring system.

Using O2Ring with wireless module at home, the data is automatically synced to the cloud during monitoring, allowing physician to easily review and analyze data on smartphone or tablet.



- APPLICATIONS:**
- COVID-19
  - SLEEP APNEA
  - ASTHMA
  - COPD
  - SPORTS
  - PILOTS

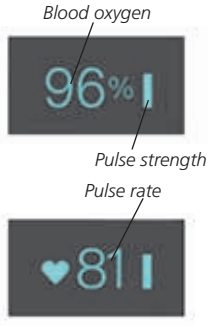

Download ViHealth App on:  
Available on the App Store | ANDROID APP ON Google Play

### TECHNICAL SPECIFICATIONS

Blood oxygen:	range: 70-99%	accuracy: 80-99%: ±2%, 70-79%: ±3%
Pulse rate:	range: 30 to 250 bpm	Low oxygen level, high/low pulse rate
Vibration source:	Recorded parameters:	Blood oxygen level, pulse rate, exercise
Weight:	15 g	
Size:	device 38x30x38 mm; ring 50-82 mm	
Built-in memory:	4 sections, up to 10 hours each section	
Battery:	Rechargeable lithium battery 3.7 Vdc	Use time: 12-16 hours
	Charge time: 2-3 hours	
Bluetooth:	Bluetooth 4.0 BLE	
Compatibility:	iOS 9.0+; Android 5.0+	
Protection:	electric shock: Type BF	electromagnetic: Group I, Class B
	dust and waterproof rating: IP24	

## OXYFIT™ PULSE OXIMETER - CONTINUOUS MONITORING

- 35058 OXYFIT™ FINGER PULSE OXIMETER

Professional, soft and wearable fingertip oximeter for continuous monitoring of SpO<sub>2</sub> and Pulse Rate during sleep or daily use. It measures, displays and stores adult results anytime, anywhere. Its unique duckbill probe has a soft chamber to check values in a comfortable and precise way.

- bright OLED display to show clear results
- built-in memory to store up to 4 sessions of record
- bar graph & pulse waveform display
- real time data can be recorded on free ViHealth App
- built-in lithium battery - automatic ON/OFF function
- sound alarms to report irregular readings.

Supplied with charging cable and user manual in GB, FR, IT, ES.



### TECHNICAL SPECIFICATIONS

SpO <sub>2</sub>	range: 70% to 100%	Built-in memory: 4 records, up to 1 hours for each
	accuracy: 80-100%: ±2%, 70-80%: ±3%	Built-in battery: rechargeable lithium-polymer battery; 3.7Vdc
Pulse Rate	range: 30 to 250 bpm	Charger: 5VDC, Max. 80mA
	accuracy: ±2 bpm or ±2%, whichever is greater	Charging time: 2-3 charging hours
Beep reminder source:	low oxygen level, high/low pulse rate	Battery life: 12-14 hours continuous working
Recorded parameters:	oxygen level, pulse rate	Bluetooth: Bluetooth 4.0 BLE
Record intervals:	4s	Protection: electric shock: Type BF
		electromagnetic: Group I, Class B
		dust and water resistance: IP22

Size: 38x30x38 mm | Weight: 28 g | Download ViHealth App on: Available on the App Store | ANDROID APP ON Google Play

## WRIST OXIMETER

- 34340 WRIST PULSE OXIMETER - with software

Small and lightweight wrist Oximeter for home and clinical long-term monitoring or for sports to measure SpO<sub>2</sub> and pulse rate (PR). Not suitable for pediatric use.

- audible and visual alarm with adjustable alarm limits
- trend review function of SpO<sub>2</sub> and PR
- selectable storage modes: 1 group/1s, 1 group/4s, and 1 group/8s
- up to 500 hours storage for SpO<sub>2</sub> and PR in default mode (1 group/8s)
- clock setting and date display function
- integrated software to download and store all measurements on PC
- comfortable to be worn on wrist as a watch



**CONTINUOUS LONG TERM MEASUREMENT**

## SHOE FOR PLASTER

GIMA code	PLASTER COVER EU SIZE	<i>Upper made of biocompatible synthetic materials mold resistant and breathable</i>
28630	N 36	<i>Non-slip rubber sole</i>
28631	N 37	
28632	N 38	
28633	N 39	
28634	N 40	
28635	N 41	
28636	N 42	
28637	N 43	
28638	N 44	
28639	N 45	
28640	N 46	
28641	N 47	

Cover plaster footwear to be worn over plaster or similar rigid bandage. It can be worn immediately after application of the plaster because breathable. The sizes are the same as for standard shoes, with appropriately increased fit. The shape is symmetrical, then the same cover can be used indifferently on the right or left foot. Washable at 30°. Medical Device Class I.

## ORTHOPEDIC SUPPORTS

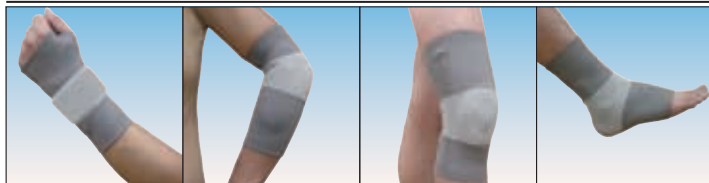

Wrist support    Elbow support    Knee support    Ankle support

Elastic knitting supports to fit body contour. Gel pad inside to release pressure for nerves, muscle, joints and improve stabilization. Hand washable.

Size	WRIST		ELBOW	KNEE	ANKLE	
	Left	Right			Left	Right
S	28731	28741	28751	28761	28771	28781
circumference	15-16 cm		21-23 cm	28-31 cm	19-21 cm	
M	28732	28742	28752	28762	28772	28782
circumference	16-17 cm		23-25 cm	31-34 cm	21-23 cm	
L	28733	28743	28753	28763	28773	28783
circumference	17-18 cm		25-27 cm	34-37 cm	23-25 cm	
XL	28734	28744	28754	28764	28774	28784
circumference	18-19 cm		27-29 cm	37-40 cm	25-27 cm	

## UNIVERSAL ARM SLINGS



• **28623 UNIVERSAL ARM SLING**  
 Universal arm sling with adjustable strap and loop contact closure. Fits left and right. Made of comfortable polypropylene material in navy colour. Machine washable.

## SOFT AND RIGID COLLARS

**SOFT CERVICAL COLLARS** - available in 3 sizes  
 This collar is made of soft expanded polyurethane lined with an anti - allergic 100% cotton fabric. Velcro fixing on the back. Multilingual instructions: GB, FR, IT, ES, PT, DE, SE, NL, GR.

**RIGID CERVICAL COLLARS** - available in 3 sizes  
 Made of polyethylene, with comfortable resting support in vinyl leather and height adjustable. Velcro straps on the back. Multilingual instructions: GB, FR, IT, ES, PT, DE, SE, NL, GR.

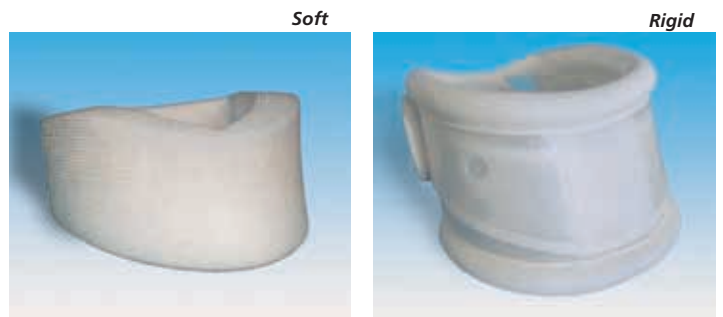

GIMA code	SOFT AND RIGID NECK COLLARS X-Ray Translucent	CE
34600	Rigid cervical collar 32-40 cm (neck circumference)	
34601	Rigid cervical collar 41-46 cm (neck circumference)	
34602	Rigid cervical collar 47-52 cm (neck circumference)	
34610	Soft cervical collar 43x8 cm - small (h 7 cm)	
34612	Soft cervical collar 46x8 cm - medium (h 8.5 cm)	
34614	Soft cervical collar 49x10 cm - large (h 10.5 cm)	

## LAERDAL STIFNECK SELECT COLLARS - ADULT AND PEDIATRIC

- 34628 LAERDAL STIFNECK SELECT EXTRICATION COLLAR - pediatric
- 34629 LAERDAL STIFNECK SELECT EXTRICATION COLLAR - adult

This product is intended to support cervical spine in a neutral position during transportation, in combination with other cervical and full body immobilization devices (CSIDs and FBSIDs).

The Laerdal Stifneck select extrication collar is four different collars in one. Stabilize spinal patients correctly and easily with 4 different sizing options that all lock quickly and safely into place.

Multilingual instructions: GB, FR, IT, ES, PT, DE, NL, DK, SE, NO, FI, PL, HR, RO, RU, CZ, SI, GR, EE.

Easily choose correct sizing option



## AMBU® REDI-ACE™



Ambu® REDI-ACE™ Mini is adjustable in 6 sizes

34638



Ambu® REDI-ACE™ Adult is adjustable in 8 sizes

34639

### AMBU® REDI-ACE™ COLLARS

Unique adjustable disposable collar available in 2 versions adult and pediatric for immobilizing of cervical column. With 8 sizes of Ambu® REDI-ACE™ and 6 sizes of Ambu® REDI-ACE™ Mini the majority of patients can be treated. Easy to use, it has an automatic flip up chin and two locking buttons. It can be placed on the patient using only 3 steps; sizing - locking - placement. Made from radiotranslucent material. Packaged completely flat. Latex free.

GIMA code	ADJUSTABLE NECK COLLARS
34638	Ambu® REDI-ACE™ paed.-yellow
34639	Ambu® REDI-ACE™ adult-blue

## AMBU® PERFIT™



Ambu® Mini Perfit™ ACE® is adjustable in 12 sizes

34640

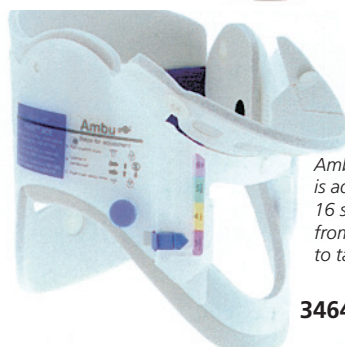

Ambu® Perfit™ ACE® is adjustable in 16 settings from neckless (size 3) to tall (size 6)

34641

### AMBU® PERFIT™ ACE® COLLARS

The Ambu® Perfit™ ACE® extrication collar is a one-piece rigid cervical spine immobilization device, available in 2 versions, adult and pediatric, both adjustable in different sizes/positions. Adult has 16 adjustments, covering neckless, short, regular and tall. Paediatric has 12 adjustments, covering infant, child, small adult. Radiotranslucent CT and MRI compatible it comes with a ventilated, posterior shell for fluid drainage. Made of polyethylene. Flat storage. Latex free.

GIMA code	ADJUSTABLE NECK COLLARS
34640	Ambu® Perfit™ paediatric-yellow
34641	Ambu® Perfit™ adult-white

## PERFIT™ MILITARY

Designed to assist with the maintenance of neutral alignment, prevention of lateral sway and anterior-posterior flexion and extension of the cervical spine during transport.



Ambu® Perfit™ ACE® Militar extrication collar is adjustable in 16 settings

34642

Flat storage



### AMBU® PERFIT™ ACE® MILITARY

Ambu® Perfit™ ACE® is also available in a military version that incorporates a camouflage colour scheme of olive drab body and charcoal black foam and label. The features and specifications are identical to Ambu® Perfit™ ACE®:

- 16 sizes in one collar
- flat storage
- radiotranslucent CT and MRI compatible
- Latex free.

GIMA code	ADJUSTABLE NECK COLLARS
34642	Ambu® Perfit™ Military

## FIRST AID CERVICAL COLLARS



34622

ONE PIECE FIRST AID NECK COLLAR



34634

TWO PIECES FIRST AID NECK COLLAR

### ONE PIECE AND TWO PIECES FIRST AID COLLAR

Made of polyethylene with washable internal part made in EVA (kind of rubber) fixed to structure by plastic rivets. With a tracheal hole, removable chin support and velcro fastener. X-ray translucent. Available in 6 sizes differentiated by safety closure colour or in a set of 6 in a bag.

GIMA code	ONE PIECE FIRST AID NECK COLLARS
34620	Infant 44-48 cm - pink
34621	Pediatric 45-48 cm - light blue
34622	Stout (bull-neck) 56-60 cm - yellow
34623	Adult small 56-62 cm - blue
34624	Adult medium 56-64 cm - orange
34625	Adult large - tall 56-66 cm - green
34626	Set of 6 collars in a bag
34627	Bag for 6 collars - green

GIMA code	TWO PIECES FIRST AID NECK COLLARS
34630	Infant 2-6 years 35-99 cm - pink
34631	Pediatric 6-12 years 40- 46 cm - light blue
34632	Stout (bull neck) 48-52 cm - yellow
34633	Adult small 50-54 cm- blue
34634	Adult medium 54-58 cm - orange
34635	Adult large - tall 56-60 cm - green
34636	Set of 6 collars in a bag
34627	Bag for 6 collars - green

## AIR CUSHION SPLINTS



• **34106 FIRST AID AIR CUSHION SPLINTS - set of 4 pieces**  
 Indispensable instrument for first aid in case of accidents, cutting and crushing injuries. Prevent surface bleeding without stopping the circulation and secure painless transportation of the injured part. The bandage is a transparent cover of PVC easy to clean and reusable, resistant against water and shifting weather conditions. X-rays can penetrate and medical diagnosis can be made without removing the bandage. The long tube (14.5 cm) with the valve make the inflation of the bandage easy, even by the injured part himself.

**Set of 4 different pieces:** full leg, foot/ankle, full arm, hand/wrist splints in a 4 compartment bag, with inflating pump.

**ALUMINIUM SPLINTS soft lining**  
 With curved edges to avoid harming yourselves. Aluminium thickness 1.2 mm.

- 34120 SPLINTS - size 13x500 mm
- 34121 SPLINTS - size 19x500 mm
- 34122 SPLINTS - size 24x500 mm



## BOSTON SPLINTS



### • 34123 BOSTON SPLINTS

Adaptable light-weight splints, x-ray translucent, coated with a non-toxic material which can be easily washed and disinfected. Size cm 92x11. Multilingual instructions: GB, FR, IT, ES, DE.

## FINGER SPLINTS

**FINGER** Set of 8 finger splints in different size (from 5 to 6.5 cm length, from 4.5 to 7.8 cm width circumference). Available in clear and skin tone colours. Made of polypropylene. With holes for air circulation and cooling.

- 34113 FINGER SPLINT KIT - clear - kit of 8
- 34115 FINGER SPLINT KIT - skin - kit of 8



## GIMASPLINTS IN 5 SIZES: LEG, ARM, FOREARM, WRIST AND ELBOW



Instructions:  
 GB, FR, IT, ES, PT

**GIMASPLINTS** these supports immobilize your limbs in an efficient and practical way. Each splint can be shaped to fit the patient's personal need. It ensures a high degree of rigid support: thanks to inner part made of neoprene lined with 100% laminated, absorbent-proof nylon assembled to a rigid metal splint. A velcro band allows a quick fixing. Available in 5 sizes or in a bag set of 5 pieces.

GIMA code	GIMASPLINTS
34680	Splint for leg - 57 cm
34681	Splint for arm - 60 cm
34682	Splint for forearm - 39 cm
34683	Splint for wrist - 33 cm
34684	Splint for elbow/ankle - 54 cm
34685	Set of 5 splints in a blue bag
34054	Bag for 5 splints - blue



## VACUUM SPLINT KIT

### • 34689 VACUUM SPLINT KIT

The set includes vacuum splints for arm (70x50 cm), leg (100x70 cm) forearm (50x30 cm) and a nylon bag. Produced with high quality materials these splints allow perfect immobilization of the lower and upper limbs by removing the air inside.

Equipped with an outside valve, to avoid troubles to the patient, and three velcro straps. Made of vinyl covered nylon, x-ray translucent.

- 34093 ALUMINIUM PUMP - for vacuum splints and mattress
- 34084 ALUMINIUM MINI PUMP

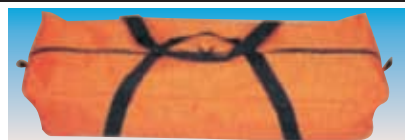



## VACUUM MATTRESS

### • 34089 MAT PLUS VACUUM MATTRESS

PVC, X-ray translucent mattress provided with 4 immobilization straps and 12 transport holes. Suitable for any kind of emergency situation. Size: 210x90 cm. Weight: 11.2 kg. Loading capacity: 150 kg. Supplied with nylon bag size 86x43x17 cm, pump not included.



34089

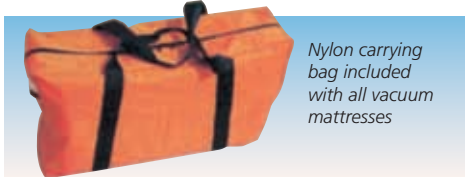

Nylon carrying bag included with all vacuum mattresses

### • 34095 ALUMINIUM PUMP for vacuum mattress

Capacity: 0.75 l. Rotating handle. Supplied with hose and fitting.



34095

MADE IN ITALY

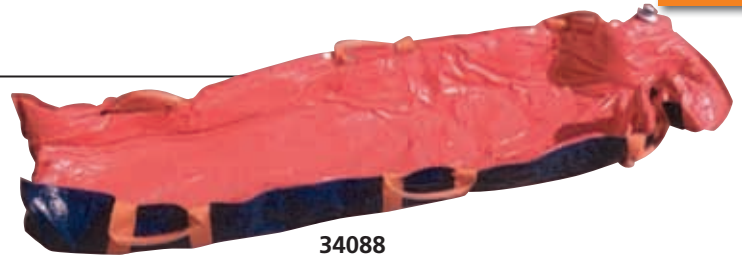

34088

### • 34088 MAT VACUUM MATTRESS

PVC, X-ray translucent mattress with 6 transport handles, perfectly fits the patient body. Sturdy material and careful manufacture make it suitable for Civil Defence, Fire Brigades, Industry and First-aid on the mountains. Size: 200x75 cm. Weight: 8.8 kg. Loading capacity: 150 kg. Supplied with nylon bag size 70x43x15 cm, pump not included.



34091

### • 34091 MAT ORANGE VACUUM MATTRESS

X-ray translucent, comfortable vacuum mattress with 8 transport handles and 4 immobilization straps. Size: 210x90 cm. Weight: 9 kg. Loading capacity: 150 kg. Supplied with nylon bag size 86x43x15 cm, pump not included.

## SEMIRIGID SPLINT KIT

### • 34119 SEMIRIGID SPLINT KIT

Kit of 3 splints (arm, wrist, leg) in nylon carrying bag. All splints are made of polyester + PVC, with lightweight stays providing high strength support. Adjustable velcro for easy use. Multilingual instructions: GB, FR, IT, RO.



34119

## EXTRICATION KITS



34028

34027

Provide horizontal flexibility and vertical rigidity support

### • 34027 SPINAL IMMOBILIZER TYPE A

### • 34028 SPINAL IMMOBILIZER TYPE B

GIMA presents 2 different shape of spinal immobilizers, both are ideal for the immobilization and setting free of patients from emergency situations. They allow to fix vertically and horizontally the head and spine of the patient to limit any injuries caused by wrong transport. X-ray translucent. Supplied with different coloured buckles and belt for easy use, padded cushion velcro straps and waterproof bag.

## BODY BAGS



### • 34116 BODY BAG - PVC

Made of PVC (Inner transparent PVC, over black), provided with two long slide fasteners. Colour: black. Size: 210x90 cm. Loading capacity: 150 kg.

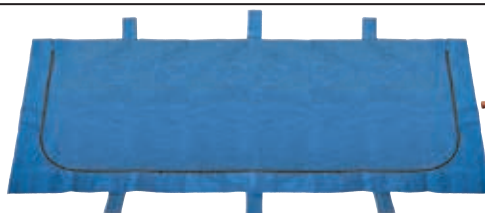

### • 34117 BODY BAG - vinyl - blue

Made of vinyl covered nylon conform to standard EN 1865. Provided with a long slide fastener. Size: 210x90 cm. Loading capacity: 150 kg.

## CARRYING COT

Multilingual manual: GB, FR, IT, ES, PT, DE

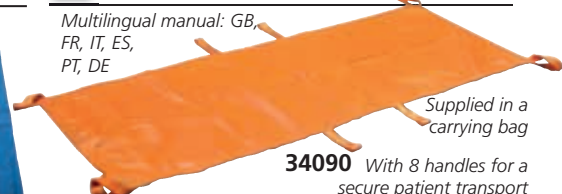

Supplied in a carrying bag

34090 With 8 handles for a secure patient transport

### • 34090 CARRYING COT

Made of polyester, PVC coated. Anti-putridity, bacterial and fungus proof, waterproof, easy to wash and disinfect, X-ray translucent material. Size 190x75 cm. Loading capacity: 150 kg. Certified EN1865-1-2010 + A1 2015

# GIMA STRETCHERS AND SPINAL BOARDS



• **34101 GIMA STRETCHER 2 - foldable in 2**  
Emergency stretcher is sturdy, but lightweight in construction, with aluminium frame and three solid iron cross-bars for heavy use. Reinforced nylon canvas, fluid repellent and non-tear.



• **34107 GIMA STRETCHER 4 - foldable in 4**  
Made of strong alloy and water-tight material. Lightweight, easy to carry, foldable in 4. Length and width are foldable in 2 parts.



• **34076 BLUE STRETCHER - foldable in 2**  
Lightweight, small sized, easy to carry. High-strength aluminium poles and vinyl coated waterproof nylon canvas.



• **34077 WHEEL STRETCHER - foldable in 2**  
Provided with wheels, outriggers and adjustable backrest. High strength aluminium poles and vinyl coated, waterproof nylon canvas. Lightweight, small sized, easy to carry.



• **34092 VALUE SPINAL BOARD**  
Lightweight, strong and economic high-density PE plate. Suitable for Radiolucent MIR and CT scan. Easy-slide allows efficient and smooth movement of patients. Board floats, excellent for water rescues.

• **34083 SPINAL BOARD**  
80% X-ray translucent\*, washable, buoyant and impervious to all fluids. Made of linear high density polyethylene with plastic pins. Compatible with all head-immobilization devices and strapping system. CT and MRI transparent. Colour orange.  
\*X-ray translucence is mainly intended for the central part of the stretcher. No translucence on the handles

• **34022 B-BAK PIN SPINAL BOARD - yellow**  
PE spinal board with Pin with robust and light structure to ensure high resistance. The 14 handles and their shape offer an easy grip, the low thickness make the application easier. Equipped with 8 plastic pins to allow easy fixing of belts with snap hook.

• **34097 SPINAL BOARD WITH SAFETY GLASS FIBRE PINS - orange**  
Strong and lightweight high density PE spinal board, with two fibre reinforced plastic stays. Provided with glass fibre pins for better fixation of immobilisation belts. Excellent in water rescues. X-ray translucent, except 2 plastic stays.

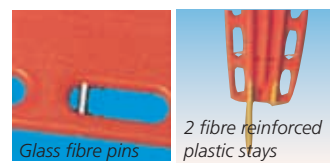

• **34023 BABY GO PEDIATRIC SPINAL BOARD**  
Baby go is a professional board, designed for children, which maintains the spine in neutral position with the ideal alignment for air flow. Board has four different profiles (two each side) which guarantee the correct position of the child according to his body size (from 47 to 150 cm). Includes 2 straps to fasten head immobilizer according to child height.

• **34024 PEDIATRIC HEAD IMMOBILIZER**  
Ensure optimal immobilization of the head of children perfectly fitting their pronounced occipital prominence.

• **34025 PEDIATRIC SPIDER STRAP SYSTEM**

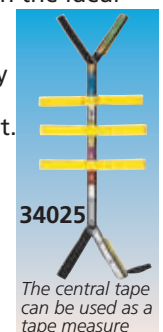

Straps to fasten head immobilizer

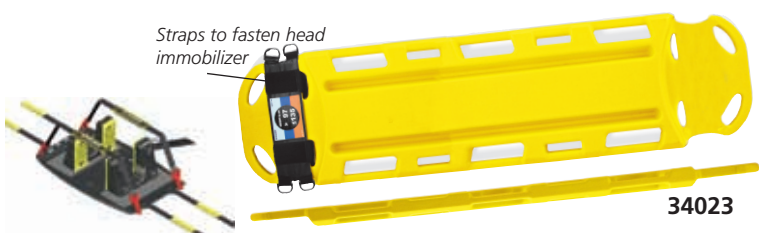

Belts not included

TECHNICAL SPECIFICATIONS	34101 GIMA 2	34107 GIMA 4	34076 BLUE	34077 WHEEL	34092 VALUE SPINAL	34083 SPINAL	34022 SPINAL WITH PINS	34097 SPINAL WITH PINS	34023 PAED SPINAL
Open size cm:	203x50x14	221x53x16	188x45x7	188x53x21	186x47x6	184x44.5x6.5	184x40.5x4.5	183x46x5	119.5x32x4.5
Folded size cm:	96x50x17	104x19x12	94x48x10	92x53x12	-	-	-	-	-
Weight:	6 kg	5 kg	4 kg	8 kg	8 kg	7.6 kg	6 kg	7 kg	2.2 kg
Load:	120 kg	159 kg	159 kg	159 kg	159 kg	150 kg	180 kg	200 kg	30 kg

## PLASTIC OR ALUMINIUM SCOOPING STRETCHERS

Supplied with multilingual manual: GB, FR, IT, ES, PT, DE

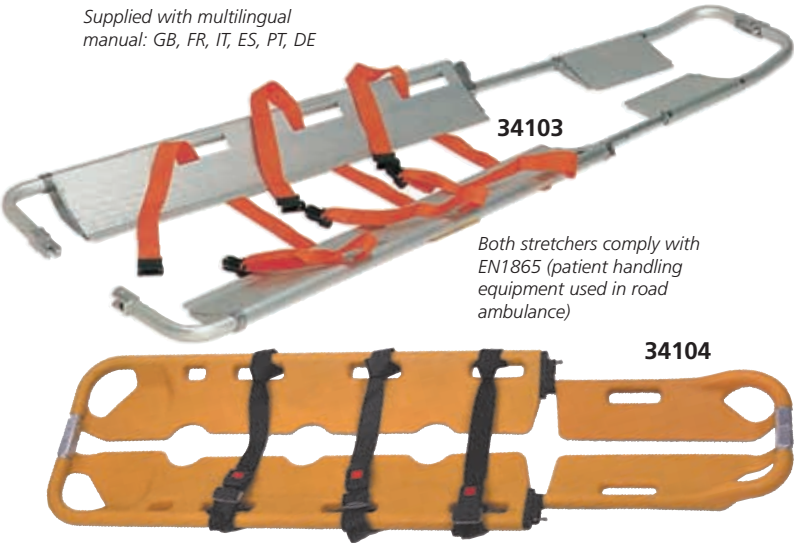

Both stretchers comply with EN1865 (patient handling equipment used in road ambulance)

- 34103 SCOOPING STRETCHER - aluminium
  - 34104 SCOOPING STRETCHER - plastic
- Practical scooping stretchers allow to put the stretcher under the patient without moving him/her much. The shape of the stretchers has been designed to immobilize the patient properly during transport.
- effective hooking and unhooking device for stretcher uncoupling
  - adjustable stretcher length with automatic locking device
  - bag with 3 quick unhooking safety belts for patient immobilization
  - once folded can be easily stored inside the ambulance
  - built in light and sturdy aluminium (34103) or plastic (34104)
  - X-ray translucent (34104 only)

### TECHNICAL SPECIFICATIONS

	34103		34104	
Open size cm:	min 171x43	max 205x43	min 164x44.5	max 200x44.5
Folded size cm:	121x43x10		118x44.5x8.5	
Weight:	8.5 kg		7.5 kg	
Load:	159 kg		159 kg	

## HEAD IMMOBILIZERS



Radiolucent material, suitable for x-ray chamber

**HEAD IMMOBILIZERS**  
Adult models of head immobilizers, different in shape, material and colour. All are composed of two head blocks and two straps to prevent any head movement of the injured person during transport.

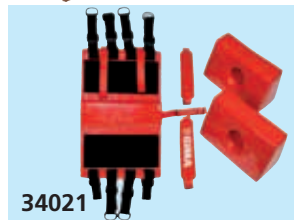

GIMA code	Type	Colour	Material
34020	FERMO-1	yellow	PE foam covered with PVC
34021	FERMO-2	red	NBR foam dipped with PVC
34026	FERMO-2	orange	NBR foam dipped with PVC
34079	CONTOUR	yellow	Moulded polyurethane and PVC

## IMMOBILISATION BELTS FOR STRETCHERS AND SPINAL BOARDS

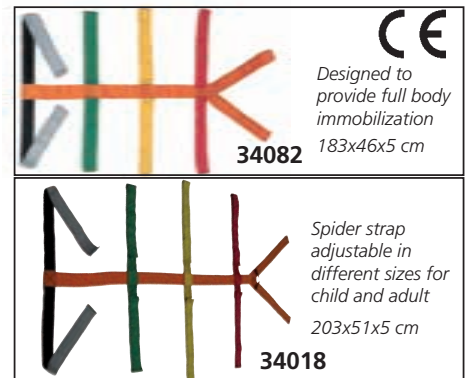

GIMA code	Type	Colour	Size cm	Max load kg	Buckle style	To be used with
34010	Belt-A	red	5x213	60	plastic snap-lock	stretchers + boards
34011	Belt-B - adjust.	black	5x213	60	2 swivel speed clip + plastic snap-lock	spinal boards with pin
34012	Belt-C	red	5x213	200	automatic quick release (unique belt)	stretchers + boards
34013	Belt-D	black	5x213	200	automatic quick release (belt in 2 pcs.)	stretchers + boards
34014	Set 3 belt-B	orange	5x274	60	2 swivel speed clip + plastic snap-lock	spinal boards
34015	Set 3 belt-D	yellow	5x213	200	2 swivel speed clip (belt in 2 pcs.)	stretchers + boards
34081	Set 3 Belts	orange	-	-	quick release plastic hook	stretchers + boards
34082	Ragno/Spider	mix	5x46x183	-	velcro strapping system	spinal boards
34018	Adjustable spider	mix	5x51x203	-	velcro strapping system - adjustable	spinal boards
32794	Nylon bag	red	-	-	-	contains up to 3 belts

## AUTOMATIC LOADING STRETCHER



34055

### • 34055 AUTOMATIC LOADING STRETCHER

Automatic stretcher to load and unload patients from emergency vehicles, can be moved by only one person. Specially designed with roll-in system to easily load and unload patients from emergency vehicle without lifting them. Legs fold under cot automatically as stretcher is rolled into the vehicle. Lock-in operating position as cot is removed from vehicle, left-hand and right-hand control levers unlock front and back legs respectively so as to be folded when cot is loaded. Polyethylene covered legs allow cot to roll smoothly in and out of vehicle. Mattress, belts, side rails, IV stand and fixing devices are included.

#### TECHNICAL SPECIFICATIONS

Maximum size (LxWxH):	193x60x88 cm
Minimum size (LxWxH):	193x60x21 cm
Packing size:	195x61x26 cm
Weight:	40 kg
Load:	159 kg



Fixing device in vehicle

## MULTIPOSITION STRETCHER



34057

### • 34057 MULTIPOSITION AUTO STRETCHER - WHEELCHAIR

Unique design multifunctional automatic stretcher, easily adjustable at different positions for emergency treatment, also in difficult situations. Front and back fixation to lock the stretcher into the ambulance at a desired position. The upper part can become a wheelchair. The stretcher can be adjusted to 6 levels, fold back and forth according to practical needs. When bent forward, the back of the stretcher is supported by fixed pneumatic springs with strapless controlling up to 60 degrees angle. Mattress, belts, side rails, I.V. stand and fixing device are included.

#### TECHNICAL SPECIFICATIONS

Maximum size (LxWxH):	198x56x89 cm
Minimum size (LxWxH):	198x56x33 cm
Packing size:	199x58x35 cm
Load:	200 kg
Net weight, Gross weight:	40 kg, 46 kg
Maximum angle of leaning forwards backwards:	0-90 degrees
The height scope of touching down (4 grades):	93 cm - 82 cm - 70 cm - 35 cm



Fixing device

## AUTOMATIC MULTIPosition STRETCHER



34072

### • 34072 FULL AUTOMATIC MULTIPosition STRETCHER

Full automatic multiposition stretcher. Easily adjustable to 6 levels for any emergency situation. Backwards and forwards reclining, back and foot rest adjustable to different positions. Can be loaded into ambulance by one operator only and locked at desired position. Structure in high-strength aluminium alloy. Soft foam surface mattress, covered by special seamless welded PVC. Protective block side rust proof and easy to clean. Mattress, belt, side rails, IV stand and fixing device are included.

#### TECHNICAL SPECIFICATIONS

Maximum size (LxWxH):	198x55x93 cm
Minimum size (LxWxH):	198x55x30 cm
Packing size:	220x60x35 cm
Load:	159 kg
Net weight, Gross weight:	39 kg, 45 kg



## WHEELCHAIR STRETCHER



34070

### • 34070 WHEELCHAIR STRETCHER

Wheelchair stretcher with varied positions. Lightweight emergency cot quickly convert to any of four chair positions for maneuvering in narrow hallways, elevators and other confined spaces. Stretcher is made of high quality aluminium alloy. Soft foam mattress and protective block side, rust proof and easy to clean. Mattress, belts, side rails, I.V. stand and fixing device are included.

#### TECHNICAL SPECIFICATIONS

Size (LxWxH):	190x57x85 cm
Packing size:	198x60x25 cm
Load:	159 kg
Net weight, Gross weight:	32 kg, 40 kg



Fixing device



## SPENCER BASKET STRETCHERS

- 34094 TWIN SHELL BASKET STRETCHER - orange
- 34098 BASKET STRETCHER - orange

Robust, resistant and flexible stretchers, ideal for a wide range of rescue operations in mines, altitude and water. A production technique ensures uniform thickness of the entire length of the stretcher. The shell is in high-density polyethylene and is joined to an aluminium framework for better strength. Integrated handles for transport are placed along the entire perimeter. The grommets for the fixing of the spring catches of the harnessing are in stainless steel. Removable mattress, applied with Velcro®, made of closed-cell EPDM, which is blood and water resistant. High density polyethylene guarantees shatterproofness and sanitization. It can contain a spine board. Supplied with nylon rope along entire perimeter, three 50 mm nylon belts with quick-release buckles, water resistant and closed-cell mattress, footrest in pre-formed polyethylene with position regulator.

### Twin shell basket stretcher

It can be transversally divided in half to improve the storage and transport. Four nylon cones and a security system protected by a protuberance placed in the mould itself, have been inserted to ensure a perfect hold between the two shells.

- 34099 LIFTING BRIDLES for 34094, 34098

Adjustable, can be used for horizontal and vertical patient lifting. Manufactured in durable woven nylon with sound steel attachment hardware and brass locking mechanism.

- 34100 FLOTATION SYSTEM for 34094, 34098
- 34096 CARRYING BAG for 34094



34098

### TECHNICAL SPECIFICATIONS

	34098	34094
Size (LxWxH):	215x65x19 cm	118/215x64x19 cm
Load capacity:	280 kg	280 kg
Weight:	13.5 kg	17 kg

34098+34100



34098+34099

34094

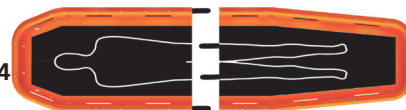

## WHEELCHAIR STRETCHERS

- 34060 WHEELCHAIR STRETCHER - 2 wheels
- 34074 WHEELCHAIR STRETCHER - 4 wheels

Specially designed for confined areas such as narrow hallways or multiple landing stairways; anywhere access is seriously limited. Made in light aluminium with waterproof orange sheet. Two rear stationary wheels Ø 12 cm (34060) or 4 wheels, 2 with brake (34074) two back handles and four front handles, 2 adjustable 30 cm, facilitate transport on most floor types. 2 quick lock safety belts immobilize patient during transport. Locking safety latch maintains chair position during use.

### TECHNICAL SPECIFICATIONS

Folded size:	91x52x19.5 cm	Open size:	91x52x71 cm
Wheelchair size:	- back height: 91 cm - width: 52 cm		
	- seat height: 48 cm - width: 52 cm		
Loading:	150 kg	Weight:	8.5 kg

Foldable down handle

Foldable up handle



34060



34060

Adjustable handle (+30 cm)



34074

## SPENCER FOLDING STAIR AND EVACUATION CHAIRS

- 34058 EVACUATION CHAIR - orange/chrome

Designed and built for emergency patient removal from confined spaces. Folded it can be stored in most ambulances.

Manufactured from chromed steel with brakes on the front wheels. Seat cover made of vinyl coated nylon, easily washable. Folds in one movement, equipped with two quick-release patient restraints.

- 34059 FOLDING CHAIR - black/yellow (orange/chrome on request)

A cost effective choice for moving patients through difficult situations. Four non-slip grip handles make lifting the patient safer and easier. Two large rear wheels provide easy manoeuvring. Tough, black, vinyl coated seat cover easy to clean, resists stain and provides bacteriostatic protection. Supplied with a set of 3 plastic buckle belts.

- 34061 SKID EVACUATION CHAIR - with braking slide

Ultra compact evacuation chair with innovative aluminium frame and tubular trellis swing fork. New concept materials and components make the chair lightweight and easy to manoeuvre to offer top performance in any scenario. Reclining armrests to increase patient comfort.

The innovative self braking slide system offers the operator total control during the stair descent. Manufactured in welded aluminium with polished finish.

Adjustable seat strengthened with Spentex®. Supplied with 2x50 mm polypropylene belts.



MADE IN ITALY

### TECHNICAL SPECIFICATIONS

	34059 FOLDING	34058 EVACUATION	34061 SKID
Height (open/closed):	92 cm	98/78 cm	154/104 cm
Width:	48 cm	41 cm	52 cm
Depth with retracted handles:	59 cm	-	-
Depth with extended handles:	125 cm	open 80 cm	-
Depth when folded handles:	19 cm	closed 31 cm	-
Weight:	10 kg	12 kg	11 kg
Load:	165 kg	116 kg	150 kg

Height open/closed 154/104 cm

34058



34061

34059

Pivoting front wheels

## COTTON GAUZE SWABS



Cotton	Plies	Threads	GAUZES - NON STERILE	Minimum order
34770	16	20	Cotton gauze swab 5x5 cm	pack of 100
34771	16	20	Cotton gauze swab 7.5x7.5 cm	pack of 100
34772	16	20	Cotton gauze swab 10x10 cm	pack of 100
34773	12	20	Cotton gauze swab 10x20 cm	pack of 150
34790		20	Cotton gauze pad 10x10 cm - 1 kg	1 pack
34791		20	Cotton gauze pad 20x20 cm - 1 kg	1 pack
34792		20	Cotton gauze pad 30x30 cm - 1 kg	1 pack

## GAUZE SWABS: COTTON, NON-WOVEN

Gauze swabs pure cotton, 20 threads, yarn 40/40, folded and hemmed without X-ray thread, non-sterile.  
Non woven swabs, 30% polyester, 70% viscose 30 g/m<sup>2</sup> folded and hemmed without X-ray thread.  
Carton of 10 packs of 100.



Cotton	Plies	Non Woven	Plies	GAUZE SWABS NON STERILE	Minimum order
35005	16	35010	4	Size 5x5 cm	box of 1,000 (10 packs of 100)
35006	12	35011	4	Size 7.5x7.5 cm	box of 1,000 (10 packs of 100)
35007	16	35012	4	Size 10x10 cm	box of 1,000 (10 packs of 100)

## COTTON GAUZE SWABS - STERILE



100% cotton gauze, 17 or 20 threads cm<sup>2</sup>, according to European Pharmacopoeia and EN 14079. Each dispenser contains sterile packs of 5 gauze swabs.

GIMA code	Plies	Threads	GAUZE SWABS - STERILE	Minimum order
35034	16	20	5x5 cm	dispenser of 250 (50 packs of 5 swabs)
35036	12	17	5x5 cm - X-ray	dispenser of 350 (70 packs of 5 swabs)
35037	12	17	7.5x7.5 cm	dispenser of 250 (50 packs of 5 swabs)
35039	12	17	10x10 cm	dispenser of 150 (30 packs of 5 swabs)
35040	12	17	10x10 cm - X-ray	dispenser of 150 (30 packs of 5 swabs)

## COTTON GAUZE BALLS - STERILE



100% cotton gauze, 20 threads cm<sup>2</sup> according to European Pharmacopoeia and EN 14079.  
Each dispenser contains sterile packs of 5 gauze balls.

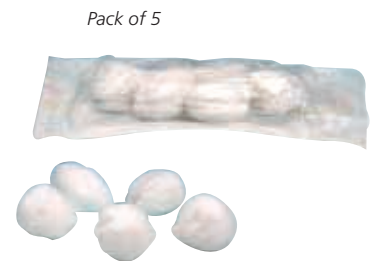

MADE IN EUROPE

GIMA code	Threads	GAUZE BALLS - STERILE	Minimum order
35045	20	Gauze balls Ø 30 mm	dispenser of 250 (50 pack of 5)
35046	20	Gauze balls Ø 40 mm	dispenser of 200 (40 pack of 5)

## COTTON GAUZE BALLS



GIMA code	ROUND COTTON GAUZE SWABS	Minimum order
34780	Cotton gauze balls Ø 30 mm	100 pcs. (1 bag of 100)
34781	Cotton gauze balls Ø 50 mm	100 pcs. (1 bag of 100)

## COTTON GAUZE BALLS

Pure hydrophilic cotton gauze balls 20 threads, yarn 40/40, without X-ray thread, non sterile package. Carton of 10 bags of 100 balls.



Cotton	Non Woven	GAUZE ROUND BALLS	Open size	Minimum order
35015	35020	Gauze ball Ø 15 mm	11x11 cm	1,000 pcs (10 bags of 100)
35016	35021	Gauze ball Ø 25 mm	12x15 cm	1,000 pcs (10 bags of 100)
35017	35022	Gauze ball Ø 50 mm	30x40 cm	1,000 pcs (10 bags of 100)

## COTTON HYDROPHILIC GAUZE - STERILE

### STERILE COTTON HYDROPHILIC GAUZE

Folded hydrophilic gauze 100% pure cotton, suitable for sterile medical dressings, to buffer and protect wounds. It allows skin perspiration. Individually packed and latex free.

Instructions and box in GB, FR, IT, ES, DE, GR

MADE IN ITALY



34768

34769

GIMA code	Threads	COTTON HYDROPHILIC GAUZE - STERILE	Minimum order
34768	12/8	Size 18x40 cm	carton of 48 box of 12 pcs
34769	12/8	Size 36x40 cm	carton of 48 box of 12 pcs

MADE IN ITALY



34767

34766

34765

GIMA code	Threads	COTTON HYDROPHILIC GAUZE - STERILE	Minimum order
34765	12/8	Size 10x10 cm	carton of 100 bags of 25 pcs
34766	12/8	Size 15x15 cm	carton of 100 bags of 25 pcs
34767	12/8	Size 20x20 cm	carton of 100 bags of 25 pcs

## LAPAROTOMIC SPONGE GAUZE



CE 0373

59394

59395

59391

59392

59393

59390

## NON WOVEN FABRIC GAUZE - STERILE

### NON WOVEN FABRIC GAUZE WITHOUT X-RAY

Non invasive device to be used as a mechanical barrier, for compression or for absorption of exudates. Intended to manage the micro environment of a wound. Maximum absorbance, it does not adhere to the wound. Made of viscose and polyester. Medical device class risk I

MADE IN EUROPE

Individually packed.



35027

35026

GIMA code	NON WOVEN FABRIC GAUZE - STERILE	Minimum order
35026	Size 18x40 cm	carton of 50 box of 12 pcs
35027	Size 36x40 cm	carton of 40 box of 12 pcs

MADE IN EUROPE



CE 0373

Each box contains 4 bags of 25 gauzes

35024

GIMA code	NON WOVEN FABRIC GAUZE - STERILE	Minimum order
35024	Size 10x10 cm	carton of 60 box of 100*

\*4 bags of 25 pcs

### LAPAROTOMIC SPONGE GAUZE - not sterile

100% cotton gauze made of 4 layers (8 layers for 59394) of 20 threads/cm<sup>2</sup>, sewn on sides and highly absorbent. Barium X-ray thread woven into the gauze, made of biocompatible polypropylene, with 60% barium sulphate. Class IIa Medical Device according to 93/42/CEE, 2007/47/CEE Latex free.

GIMA code	Plies	Threads	LAPAROTOMIC SPONGE GAUZE	Minimum order
59390	4	20	Size 10x60 cm	box of 600
59391	4	20	Size 20x20 cm	box of 600
59392	4	20	Size 30x30 cm	box of 600
59393	4	20	Size 40x40 cm	box of 250
59394	8	20	Size 40x40 cm	box of 250
59395	4	20	Size 50x50 cm	box of 250

## 100% COTTON GAUZE ROLLS



59412

59411

59410

### GAUZE ROLLS

100% cotton gauze rolls with 20 threads sq cm according to European Pharmacopoeia and EN 14079. X-Ray detectable thread (approx. 60% barium sulphat) 80 cm width, folded 8 to 10 cm ply. Multilingual box: GB, FR, IT, ES, PT, DE, NL, SE.

GIMA code	Extended width	Folded width	Plies	Threads sq cm
59410	80 cm x 1 m	10 cm x 1 m	8	20
59411	80 cm x 2 m	10 cm x 2 m	8	20
59412	80 cm x 10 m	10 cm x 10 m	8	20

## 100% COTTON RIBBON GAUZE

- Latex and PVC free  
- Absorption of fluids inside cavities  
- Wound care during surgery



Multilingual box:  
GB, FR, IT, ES, PT, DE, NL, SE

GIMA code	GIMA code	100% COTTON RIBBON GAUZE weight 33 g/sq. m 22 threads/sq. m	Minimum order
-	X-Ray*		
59420	59430	5 m x 1.25 cm	box of 24
59421	59431	5 m x 2.5 cm	box of 12
59422	59432	5 m x 5 cm	box of 12
59423	59433	5 m x 7.5 cm	box of 8
59424	59434	5 m x 10 cm	box of 6
59440	-	5 m x 1.25 cm - sterile	box of 60
59441	-	5 m x 2.5 cm - sterile	box of 30
59442	-	5 m x 5 cm - sterile	box of 26

\*X-Ray: approx. 60% barium sulphat contents

## STERILE ABSORBENT PADS



Multilingual box:  
GB, FR, IT, ES,  
PT, DE, NL, SE

Ideal for situations where a great capacity of absorption is needed, such as bleedings and chronic wounds. Made of cellulose pulp, white and blue polypropilene and tissue paper.

GIMA code	STERILE ABSORBENT PADS	Minimum order
59402	10x10 cm	box of 60
59403	10x20 cm	box of 30
59404	20x20 cm	box of 30
59405	20x40 cm	box of 25

## DENTAL COTTON ROLLS

• 35000 COTTON ROLLS 1x3.8 cm  
100% cotton interior, soft, pliable, non-linting, non-irritating rolls. Highly absorbent up to 6 times their weight. Will not adhere to mucous membranes, maintains shape better when wet, non sterile. Minimum order: carton of 10 boxes of 1,000 pcs.



35000



## 100% COTTON WOOL



### 100% COTTON WOOL

Hydrophilic 100% cotton for sanitary and cosmetic use, hygiene, non-injured skin disinfection. Non-invasive Class I Medical device. Non sterile. Multilingual pack: GB, FR, IT, DE, ES, FI, GR, HR, PL, PT, RO, SE.

GIMA code	COTTON WOOL	Type	Closing laces	Minimum order
34831	Cotton wool 100 g	Z folded	yes	box of 100 packs
34834	Cotton wool 250 g	Z folded	yes	box of 40 packs
34835	Cotton wool 500 g	Z folded	-	box of 20 packs
34838	Cotton wool 1000 g	roll	-	box of 10 packs
34839	Cotton wool 1000 g	Z folded	-	box of 10 packs

## SURGIFIX® ELASTICATED TUBULAR NETTING

Surgifix® is a unique elastic tubular netting, light, soft and breathable. It is the ideal solution for gauze or dressing retention. Its unique structure makes it suitable for any part of the body, thus assuring perfect dressing adhesion under ideal compression grade and offering unrivalled patient's comfort. Surgifix can be cut at the requested length.

Two ranges: Poly (polyester 38%, polyamide 35%, latex 27%) and Zerolatex (polyamide 86%, elastomer 14%).



Multilingual box (GB, FR, IT, ES, DE) and instructions (GB, FR, IT, ES, PT, DE, HU, PL, BG, GR, RO, SE, SI, NO, NL, LT, LV, CZ, DK, FI, RU, TR, SK, EE, JP, Arabic).

POLY			SURGIFIX® ELASTICATED TUBULAR NETTING Length under tension: 25 m	ZEROLATEX		
Code	Range	Width* mm		Code	Range	Width* mm
34701	1	18	Net for fingers	-	-	-
34702	2	20	Net for wrist, hand	-	-	-
34703	3	22	Net for hand, elbow, arm	58903	C	38
34704	4	28	Net for elbow, arm, foot	58904	C/D	48
34705	5	30	Net for foot, knee, leg	58905	E	62
34706	6	56	Net for head, shoulder, pelvis, leg	58906	F	78
34707	7	61	Net for body, pelvis, thigh	58907	G	88
34708	8	65	Net for shoulder, body, back	-	-	-
34709	9	85	Net for shoulder, body, back	-	-	-
34700	10	114	Net for shoulder, body, back	-	-	-

\*Different width between Poly and Zerolatex is due to different elasticity of materials

MADE IN ITALY





## LEUKOTAPE® K NEUROMUSCULAR TAPE



### NEUROMUSCULAR TAPE

Elastic adhesive tape for neuromuscular taping. 100% cotton fabric coated with a strong acrylic adhesive mass. Water resistant. Latex-free. Multilingual box: GB, FR, IT, ES, DE, PT, NL.

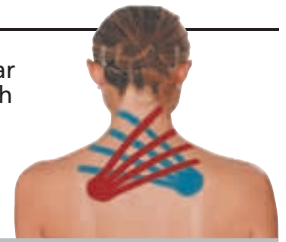

GIMA code	BSN code	LEUKOTAPE® K NEUROMUSCULAR TAPE
59010	72978-11	LEUKOTAPE® K 5 m x 5 cm - skin
59011	72978-16	LEUKOTAPE® K 5 m x 5 cm - red
59012	72978-21	LEUKOTAPE® K 5 m x 5 cm - blue
59013	72978-23	LEUKOTAPE® K 5 m x 5 cm - black
59014	72978-24	LEUKOTAPE® K 5 m x 5 cm - light blue
59015	72978-25	LEUKOTAPE® K 5 m x 5 cm - pink

## KINTAPE KINESIOLOGY TAPES

High quality Kinesiology tape conforms to all areas of the body. Provides firm support and compression. Ideal for treatment of muscular symptoms, stimulus to blood circulation and lymph and fascia diversion. Reduce pain improving athletic performance. Easy to tear and unwinds to the core. Individually packed in a plastic bag and cardboard box. - soft hypoallergenic cotton cloth, elasticity up to 160%

- 70% water proof (level 3) and sweat proof - supersticky: up to 7 days, over 10 days for kinesiology PRO **Kinesiology PRO:** supersoft and quick drying

Multilingual box and instructions (GB, FR, IT, ES)



34746



Mixed colours box includes 6 rolls in different colours: ceil blue, red, pink, green, black, beige

Made of 97% cotton, 3% spandex



CE  
34752

GIMA code	KINESIOLOGY STANDARD TAPES - thickness 0.48 mm	Minimum order
34745	Kinesiology tape 5 m x 5 cm - black	box of 1
34746	Kinesiology tape 5 m x 5 cm - ceil blue	box of 1
34747	Kinesiology tape 5 m x 5 cm - red	box of 1
34749	Kinesiology tape 5 m x 5 cm - green	box of 1
34750	Kinesiology tape 5 m x 5 cm - pink	box of 1
34751	Kinesiology tape 5 m x 5 cm - skin	box of 1
34752	Kinesiology tapes 5 m x 5 cm - mix colours	box of 6
KINESIOLOGY PRO TAPES - thickness 0.32 mm		
34757	Kinesiology PRO tapes 5 m x 5 cm - skin	box of 1

## PEHA-HAFT® ELASTIC COHESIVE BANDAGES - LATEX FREE



### PEHA-HAFT® ELASTIC COHESIVE BANDAGES

Single-use cohesive conforming bandages for retention of primary and secondary dressings (such as splints, casts, catheters and cannulas) particularly on joints as well as on conical and round parts of the body. Double adhesive effect due to its crêpe texture and micro-structured coating.



-85 % extensibility  
-low consumption of material due to its strong self-adhesive effect

-bandage adheres to itself, but not to skin, hair or clothing -permeable to air and skin-friendly.

Ideal for the stabilization of muscles, tendons, ligaments, joints with low immobilization effect. Also used in medical interventions when acute and chronic wounds need to be treated short or long term.

It is made of 43% viscose, 37% cotton and 20% polyamide.



GIMA code	Hartmann code	PEHA-HAFT® ELASTIC COHESIVE BANDAGES - LATEX FREE	Minimum order
59230	932451	Peha-haft® 4 m x 2.5 cm	box of 8
59231	932441	Peha-haft® 4 m x 4 cm	box of 1
59232	932442	Peha-haft® 4 m x 6 cm	box of 1
59233	932443	Peha-haft® 4 m x 8 cm	box of 1
59234	932444	Peha-haft® 4 m x 10 cm	box of 1
59235	932445	Peha-haft® 4 m x 12 cm	box of 1
59236	932446	Peha-haft® 20 m x 4 cm	box of 1
59237	932447	Peha-haft® 20 m x 6 cm	box of 1
59238	932448	Peha-haft® 20 m x 8 cm	box of 1
59239	932449	Peha-haft® 20 m x 10 cm	box of 1
59240	932450	Peha-haft® 20 m x 12 cm	box of 1

## ELASTOMULL® HAFT COHESIVE BANDAGES



Multilingual box:  
GB, FR, IT, ES, DE,  
PT, NL, SE

### ELASTOMULL® COHESIVE BANDAGES

Elastic retention bandage. It provides wound care splint retention and light support. Comfortable non woven fabric (cotton, viscose and polyamide) coated with synthetic latex. Stretched length 4 m.



GIMA code	BSN code	ELASTOMULL® HAFT COHESIVE BANDAGES	Minimum order
59211	45471-00	Elastomull® Haft 4 m x 6 cm	box of 10
59212	45472-00	Elastomull® Haft 4 m x 8 cm	box of 10
59213	45473-00	Elastomull® Haft 4 m x 10 cm	box of 10
59218	45477-00	Elastomull® Haft 20 m x 8 cm	box of 1
59219	45478-00	Elastomull® Haft 20 m x 10 cm	box of 1

## ELASTIC COHESIVE BANDAGES



Ideal for supporting light joint fractures and to fix dressings.

This bandage does not require clips because perfectly adherent.

### TECHNICAL SPECIFICATIONS

Composition: 42% cotton, 29% viscose, 29% polyamide, latex or latex free  
Width: 6-8-10-12 cm - Length: stretched length 4 m  
Extensibility: approx. 50%

GIMA code	ELASTIC COHESIVE BANDAGE	Minimum order
34657	Cohesive bandage 4 m x 6 cm	box of 10
34658	Cohesive bandage 4 m x 8 cm	box of 10
34659	Cohesive bandage 4 m x 10 cm	box of 10
34660	Cohesive bandage 4 m x 12 cm	box of 10
34661	Cohesive bandage 20 m x 6 cm	box of 1
34662	Cohesive bandage 20 m x 8 cm	box of 1
34663	Cohesive bandage 20 m x 10 cm	box of 1
34664	Cohesive bandage 20 m x 12 cm	box of 1
GIMA code	ELASTIC COHESIVE BANDAGE - LATEX FREE	Minimum order
59201	Cohesive bandage 4 m x 8 cm	box of 10
59202	Cohesive bandage 4 m x 10 cm	box of 10
59203	Cohesive bandage 4 m x 12 cm	box of 10
59206	Cohesive bandage 20 m x 8 cm	box of 1
59207	Cohesive bandage 20 m x 10 cm	box of 1
59208	Cohesive bandage 20 m x 12 cm	box of 1

## COHESIVE BANDAGES

### AUTOFIX HAFT ELASTIC COHESIVE BANDAGES

Cohesive bandage with instantaneous and lasting fixation.

It adheres only to itself and not to the skin, hair or clothing.

Doesn't slip, is air-permeable, with stretchability of approx 50%.

Comfortable, well tolerated by skin, it adapts perfectly to part that has to be treated.

Versatile to use, easy to apply, permits free movement.

Made of cotton (42%), viscose 29%, polyamide 29%.

MADE IN EUROPE



GIMA code	AUTOFIX HAFT COHESIVE BANDAGE	Minimum order
34710	Cohesive bandage size 4 m x 6 cm	box of 72 pcs
34711	Cohesive bandage size 4 m x 8 cm	box of 72 pcs
34712	Cohesive bandage size 4 m x 10 cm	box of 36 pcs
34713	Cohesive bandage size 4 m x 12 cm	box of 36 pcs

## ELASTIC COLOUR COHESIVE BANDAGES - EXTENSIBILITY 90%

Cohesive bandages through microfine latex dots

- for fixing dressings  
- ideal for supporting joint treating light fractures  
- this bandage does not require clips because it remains well-attached to itself.

### TECHNICAL SPECIFICATIONS

Composition: 42% cotton, 29% viscose, 28% polyamide, 1% elastan and latex  
Width: 6 - 8 - 10 cm Length: stretched length 4 m  
Extensibility: approx. 90%

### COHESIVE COLOUR BANDAGE

Size	Green	Blue	Red	Yellow	Mixed colours*	Minimum order
4 m x 6 cm	-	34665	34666	-	34668	box of 10
4 m x 8 cm	34669	34670	34671	34672	34673	box of 10
4 m x 10 cm	34674	34675	34676	-	34678	box of 10

\*Mix 2 bandages x 5 colours (red, green, blue, yellow, white)

Cohesive through microfine latex dots



## PREVITNT COHESIVE NON WOVEN ELASTIC BANDAGES

### PREVITNT NON WOVEN ELASTIC BANDAGES

For fixing dressings.

Ideal for supporting joints, treating light fractures.

This bandage does not require clips because it remains well-attached to itself.

Particularly suitable for use on joints, for sports and veterinary use.

Composition: 85% polypropylene - 15% spandex and latex.

Extensibility: approx 100%.

### COHESIVE COLOUR NON WOVEN BANDAGE

Size	Blue	Red	Mixed colours*	Minimum order
4.5 m x 7.5 cm	34734	34735	34736	box of 10
4.5 m x 10 cm	34738	34739	34740	box of 10

\*Mix 2 bandages x 5 colours (red, green, blue, yellow, skin)



## COMPRILAN® COMPRESSIVE BANDAGES



**COMPRILAN® COMPRESSIVE BANDAGES**  
Short stretch compression bandage (90%) for phlebological and lymphological application. 100% cotton fabric (flesh colour). Stretched length 5 m. Washable and sterilizable. Latex-free.

GIMA code	BSN code	COMPRILAN® COMPRESSIVE BANDAGES	Minimum order
59150	01026-00	COMPRILAN® 5 m x 6 cm	box of 1
59151	01027-00	COMPRILAN® 5 m x 8 cm	box of 1
59152	01028-00	COMPRILAN® 5 m x 10 cm	box of 1
59153	01029-00	COMPRILAN® 5 m x 12 cm	box of 1

## ELASTIC COMPRESSION BANDAGES - LIGHT TO STRONG COMPRESSION



**PREVIBIELASTICA**  
- medical prescription bandage  
- ideal for bandaging when support and strong, constant compression is required  
- used in the treatment of varicose veins and post-operative patients  
- its ability to stretch in any direction makes it ideal for bandaging joints.



**PREVIFORTE**  
- medical prescription bandage  
- compression bandage for phlebitis treatment  
- support bandage with strong, constant compression, ideal for varicose veins, for the prevention and cure of sport and work injuries. Suitable for distortions, light fractures and sprains.



**PREVINOVA**  
- universal compression bandage  
- protects and supports all types of medication  
- to fix medications, support light fractures, distortions, sprains, sport and work injuries with medium compression.



**PREVIMEDICAL**  
- universal compression bandage  
- protects and supports all types of medication  
- to fix medications, for support and relief in case of contusions and haematomas with medium-light compression.

		TECHNICAL SPECIFICATIONS			
		PREVI BIELASTICA	PREVI FORTE	PREVI NOVA	PREVI MEDICAL
Composition:	Cotton	70%	92%	69%	60%
	polyamide	19%	-	25%	33%
	polyurethane	11%	8%	6%	7%
Extensibility	longitudinal	160%	170%	250%	160%
	transversal	80%	-	-	-

GIMA code	ELASTIC COMPRESSION BANDAGES individually packed, with clip		Minimum order
<b>PREVIBIELASTICA - strong compression</b>			
34644	PreviBielastica	7 m x 8 cm	box of 10
34645	PreviBielastica	7 m x 10 cm	box of 10
34646	PreviBielastica	7 m x 12 cm	box of 10
<b>PREVIFORTE - strong compression</b>			
34647	PreviForte	7 m x 8 cm	box of 10
34648	PreviForte	7 m x 10 cm	box of 10
<b>PREVINOVA - medium compression</b>			
34650	PreviNova	4.5 m x 6 cm	box of 10
34651	PreviNova	4.5 m x 8 cm	box of 10
34652	PreviNova	4.5 m x 10 cm	box of 10
<b>PREVIMEDICAL - medium light compression</b>			
34654	PreviMedical	5 m x 8 cm	box of 10
34655	PreviMedical	5 m x 10 cm	box of 10

## CO-PLUS® BANDAGES

**CO-PLUS® BANDAGES**  
Flexible cohesive bandage. Sticks only to itself, not on skin. Indications: support and compression in traumatology and phlebology. Longer than competitors (6.3 m stretched instead of 4.5 m).

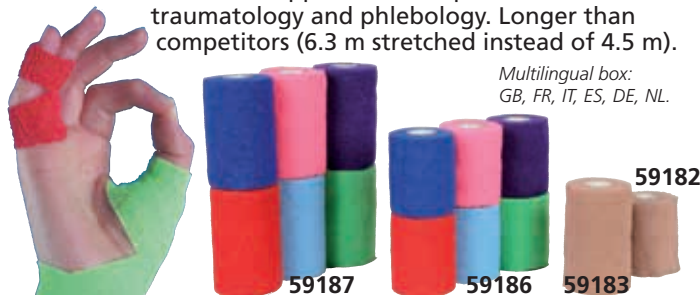

GIMA code	BSN code	CO-PLUS® BANDAGES	Minimum order
59182	72100-09	CO-PLUS® 6.3 m x 7.5 cm - skin	box of 1
59183	72100-04	CO-PLUS® 6.3 m x 10 cm - skin	box of 1
59186	72102-03	CO-PLUS® 6.3 m x 7.5 cm - mix colours*	box of 24
59187	72102-02	CO-PLUS® 6.3 m x 10 cm - mix colours*	box of 18

\*Mix of bandages in 6 colours (blue, light blue, red, violet, neon green, neon pink)

## 3M™ COBAN™ ELASTIC WRAP



GIMA code	3M code	3M COBAN™ SELF ADHERENT COHESIVE ELASTIC WRAP - LATEX	Minimum order
34929	1581	COBAN™ 2.5 cm x 2 to 4.57 m	box of 30
34928	1582	COBAN™ 5 cm x 2 to 4.57 m	box of 36
34923	1583	COBAN™ 7.5 cm x 2 to 4.57 m	box of 24
34924	1584	COBAN™ 10 cm x 2 to 4.57 m	box of 18

## TENSOPLAST® ELASTIC ADHESIVE BANDAGES



**TENSOPLAST® BANDAGES**  
Elastic adhesive bandage. High quality elastic fabric, soft edges and porous adhesive mass. Yellow center line. It provides strong support and compression in traumatology and phlebological disease. Stretched length 4.5 m. Multilingual box: GB, FR, IT, ES, DE, PT, GR, NL, SE.



GIMA code	BSN code	TENSOPLAST® BANDAGES
59250	71545-00	TENSOPLAST® 4.5 m x 5 cm
59251	71546-00	TENSOPLAST® 4.5 m x 7.5 cm
59252	71547-00	TENSOPLAST® 4.5 m x 10 cm

## GAUZE BANDAGES

For fixing dressing and for absorption of exudates. 100% cotton wool. Latex free.



MADE IN EUROPE

GIMA code	Threads	GAUZE BANDAGES - DISPOSABLE	Minimum order
34840	20	Gauze bandage 3.5 m x 5 cm	box of 12
34841	20	Gauze bandage 3.5 m x 7 cm	box of 10
34842	20	Gauze bandage 3.5 m x 10 cm	box of 6
34844	20	Gauze bandage 5 m x 5 cm	box of 100
34846	20	Gauze bandage 5 m x 7 cm	box of 100
34847	20	Gauze bandage 5 m x 10 cm	box of 100

## FIXATION ELASTIC BANDAGES

For fixing dressing, for support and light compression. Its characteristic crepe like touch enables the bandage to remain well-attached to itself. Well-tolerated by the skin, it ensures a high level of breathing. Washable at 60°C. Made of 99% cotton - 1% lycra. MADE IN EUROPE



GIMA code	PREVICREPE S FIXATION ELASTICATED BANDAGES - 75 g²	Minimum order
34725	Previcrepe bandage 4 m x 5 cm	box of 10
34726	Previcrepe bandage 4 m x 7 cm	box of 10
34727	Previcrepe bandage 4 m x 10 cm	box of 10
34728	Previcrepe bandage 4 m x 15 cm	box of 10

## ELASTICATED BANDAGES

Elasticated **non adhesive** bandages for containment, individually cellophane wrapped, in a box. Non adhesive bandages are made of 65% cotton and 35% polyamide fibre. Provided with clasp.



34722

MADE IN ITALY

GIMA code	ELASTICATED BANDAGES	Minimum order
34720	Bandage size 4.5 m x 5 cm	box of 20
34721	Bandage size 4.5 m x 7 cm	box of 20
34722	Bandage size 4.5 m x 10 cm	box of 20

## ELASTICATED ADHESIVE BANDAGES

Plaster bandages with hypoallergenic, synthetic adhesive containing zinc oxide, for permanent compression and functional dressings. Hypoallergenic, porous, air permeable with woven edges, can be sterilized by ethylene oxide. 100% cotton, latex free.



34785

MADE IN SWITZERLAND

GIMA code	ELASTICATED ADHESIVE BANDAGES	Minimum order
34783	Adhesive bandage size 2.5* m x 6 cm	box of 10
34784	Adhesive bandage size 2.5* m x 8 cm	box of 10
34785	Adhesive bandage size 2.5* m x 10 cm	box of 10

\*Length: 2.5 m non stretched, up to 4.5 m stretched

## HYPOR-PLAST

**Adhesive soft roll for fixation**  
White extensible non-woven bandage roll. Extremely breathable and conformable. Hypoallergenic, reliable skin friendly acrylic adhesive. Medical Devices, Class I.  
**Indications:** suitable to fix catheters, gauze and other dressings.



Multilingual box: GB, FR, IT, ES, PT

MADE IN ITALY

GIMA code	EXTENSIBLE ADHESIVE BANDAGE
34863	roll m 10 x 5 cm
34864	roll m 10 x 10 cm
34865	roll m 10 x 15 cm
34829	roll m 10 x 20 cm

## EMOCONTROL

• **34782 EMOCONTROL**  
Emocontrol is an easy, quick and effective elastic bandage for injuries and small haemorrhages. Length 4.5 m, width 10 cm with a 10x10 cm pad and 2 clips. Instructions: GB, IT.



MADE IN ITALY

## STRAPPAL® SPORT TAPE

### STRAPPAL® SPORT TAPE

Inelastic adhesive bandage (tape) indicated in traumatology to limit the joint movements.

High quality fabric made of inelastic viscose fibres coated with a strong adhesive mass. Hand tearable. Latex free.

Multilingual GB, FR, IT, ES, DE, PT, NL.



GIMA code	BSN code	STRAPPAL® SPORT TAPE	Minimum order
59051	71490-00	STRAPPAL® 10 m x 4 cm	box of 24
59052	71493-00	STRAPPAL® 10 m x 5 cm	box of 18



## 3M™ SCOTCHCAST™ PLUS



### 3M™ SCOTCHCAST™ CASTING PLUS TAPE

A lightweight, strong and durable casting tape that combines the benefits of a fiberglass casting tape with the handling ease of plaster.

- water-activated resin lets you control working time according to application needs
- high and early strength allows for weight bearing in 20 minutes and provides a durable cast with less chance of breakdown and the need for costly repairs or replacements
- lightweight for easy mobility
- stretches to conform well to contours for a more comfortable, better fitting cast
- porous weave allows the skin to breathe

GIMA code				3M code	3M™ SCOTCHCAST™ PLUS	Minimum order
White	Green	Red	Blue			
59610	59611	59612	59613	82002	5 cm x 3.65 m	box of 10
59620	59621	59622	59623	82003	7.5 cm x 3.65 m	box of 10
59630	59631	59632	59633	82004	10 cm x 3.65 m	box of 10
59640	-	-	59643	82005	12.7 cm x 3.60 m	box of 10

## 3M™ SOFT-CAST



### 3M™ SOFT-CAST CASTING TAPE

A fiberglass casting tape that does not set to a completely rigid state, but remains flexible and soft even when it is completely cured.

- the soft, pliable cast edges improve patient comfort
- can be used in combination with rigid fiberglass splints, as soft edges provide additional comfort

#### Suggested Applications:

- sports Medicine: thumb, wrist and ankle sprains
- pediatric Orthopedics: serial casting for club foot treatment
- general Orthopedics: secondary casting, hybrid casting, corsets
- occupational Therapy: removable splints



59663

## 3M™ SYNTHETIC CAST STOCKINET™



### 3M™ SYNTHETIC CAST STOCKINET™

3M™ Stockinet is a synthetic tubular knit in polyester fibers, used as protection of the patient's skin under the synthetic plaster braces. It is not a sterile product, but can be steam sterilized in an autoclave.

Water repellent and therefore suitable for use with Soft Cast as a water proof cast.

Suitable for use with all casting materials, plaster and synthetic.



GIMA code	3M code	3M™ STOCKINET™	Minimum order
59701	MS02	STOCKINET™ 5 cm x 22.8 m	1
59702	MS03	STOCKINET™ 7.5 cm x 22.8 m	1
59703	MS04	STOCKINET™ 10 cm x 22.8 m	1

## 3M™ SYNTHETIC UNDER-CAST PADDING



### 3M™ SYNTHETIC UNDER-CAST PADDING

Porous and highly conformable non-woven polyester padding. Strong, yet easy to tear.

- synthetic cast padding
- non-woven polyester padding which is porous, and highly conformable
- easy to tear
- suitable for use with all casting materials

GIMA code	3M code	3M™ SYNTHETIC UNDER-CAST PADDING	Minimum order
59715	MW02	UNDER-CAST PAD 5 cm x 2.7 m	box of 12
59716	MW03	UNDER-CAST PAD 7.5 cm x 2.7 m	box of 12
59717	MW04	UNDER-CAST PAD 10 cm x 2.7 m	box of 12
59718	MW06	UNDER-CAST PAD 15 cm x 2.7 m	box of 12

## ZINCA BAND E



CE  
**surgifix** 34717

MADE IN GERMANY

- 34715 ZINCA BAND E ELASTIC BANDAGE 5 m x 10 cm
- 34717 ZINCA BAND E ELASTIC BANDAGE 10 m x 10 cm

Elastic bandage impregnated with zinc oxide paste. Support for treatment of leg ulcers, varices, thrombosis and post-care for fracture, dislocations, bone and joint surgery. Each band is packed in sealed aluminium foil bag and multilingual box: GB, IT. Medical device.

### TEXTILE COMPOSITION

Viscose 69% - Polyamide 31% - Soaked with zinc oxide, gelatine, glycerin, propyl-hydroxybenzoate, methyl-hydroxybenzoate, water. Elasticity: 75%

## PREVIZINC A and E

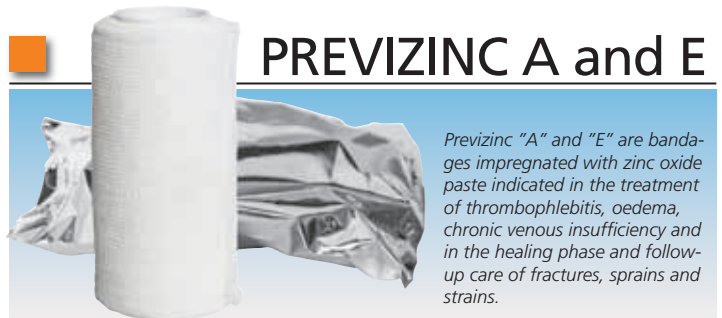

Previzinc "A" and "E" are bandages impregnated with zinc oxide paste indicated in the treatment of thrombophlebitis, oedema, chronic venous insufficiency and in the healing phase and follow-up care of fractures, sprains and strains.

GIMA code	PREVIZINC "A" INELASTIC BANDAGES	Minimum order
34714	Previzinc "A" 6 m x 8 cm	box of 10
34716	Previzinc "A" 5 m x 10 cm	box of 10
PREVIZINC "E" ELASTIC BANDAGES		
34718	Previzinc "E" 6 m x 8 cm	box of 10
34719	Previzinc "E" 5 m x 10 cm	box of 10
34724	Previzinc "E" 7 m x 10 cm	box of 10

### TEXTILE COMPOSITION

Previzinc A: 100% cotton zinc oxide paste  
Previzinc E: 54% polyamide, 46% viscose zinc oxide paste

## 3M RESTON™ FOAM PAD

Self-adhering open cell foam designed to protect skin from splints, casts and prostheses. Not intended to be used as a pressure reducing device. It can also be used as a padding for beds and chairs. Can be cut, layered and shaped.



GIMA code	3M code	3M RESTON™ FOAM PAD	Minimum order
34920	1560	RESTON™ 30x20x1.25 cm	box of 10
34921	1561	RESTON™ 30x20x2.5 cm	box of 5
34922	1563	RESTON™ ROLL 10cmx5mx5mm	1 roll



## PLATRIX® HIGH QUALITY PLASTER OF PARIS BANDAGES



### PLATRIX® PLASTER OF PARIS

High quality plaster of Paris bandages. Economic thanks to the high strength and the minimal plaster loss.



GIMA code	BSN code	PLATRIX® PLASTER OF PARIS	Minimum order
34686	71996 - 05	Platrix® 2 m x 15 cm	box of 40
34688	71996 - 14	Platrix® 3 m x 20 cm	box of 20
34691	71996 - 28	Platrix® 4 m x 20 cm	box of 20

## OSCILLATING PLASTER SAW

### • 59099 HEBU GOLD II PLASTER SAW

The new oscillating professional saw can quickly, safely, quietly and accurately remove all plaster of Paris and synthetic dressings.

High-performance motor with electronic speed regulation and a gradual start-up, gently on materials. Motor is cooled using the circulation principle.

Cool air is suctioned in at the end of the motor, to protect power aggregate from resin dust and residues. Made of high quality materials

- 59101 SAW BLADE Ø 50 mm
- 59102 SAW BLADE Ø 65 mm



MADE IN GERMANY

UP TO 21,000 OSCILLATIONS

### STANDARD ACCESSORIES

Saw blade Ø 50 mm  
Saw blade Ø 65 mm  
One pair of wrenches  
User manual: GB, FR, IT, ES, DE

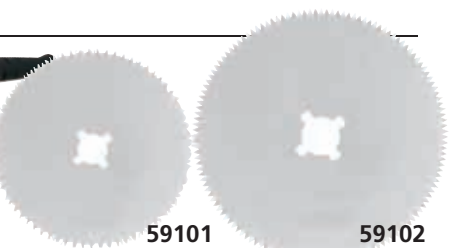

### TECHNICAL SPECIFICATIONS

Voltage: 220-240 V, 50-60 Hz  
Power: 250 W  
Strokes: 12,000 - 21,000 oscillations/min  
Length without cord: 340 mm  
Weight with/without cable: 1.3/1.7 Kg  
Noise: 68-82 dB  
Cord length: 4.5 m  
IP code: IP20

## 3M™ STERI-STRIP™ - REINFORCED ADHESIVE SKIN CLOSURE

Adhesive skin closures made of non-woven backing coated with a pressure-sensitive hypoallergenic adhesive. Sterile, breathable and comfortable to wear.

### 3M™ STERI-STRIP™ REINFORCED ADHESIVE SKIN CLOSURE

With polyester reinforcing filaments for higher tensile strength, reduced infection and scarring risk and better cosmetic outcomes.



### ELASTIC STERI-STRIP™

Stretches with body movement or edema. Mostly suited for special applications (e.g. joints) or plastic surgery. Skin tone.



GIMA code	3M code	3M REINFORCED STERI-STRIP™ - sterile - skin closure	Minimum order
34909	R1540	STERI-STRIP™ - 3x75 mm	50 bags of 5 strips
34910	R1541	STERI-STRIP™ - 6x75 mm	50 bags of 3 strips
34908	R1542	STERI-STRIP™ - 6x38 mm	50 bags of 6 strips
34911	R1546	STERI-STRIP™ - 6x100 mm	50 bags of 10 strips
34913	R1549	STERI-STRIP™ - 12x50 mm	50 bags of 6 strips
34912	R1547	STERI-STRIP™ - 12x100 mm	50 bags of 6 strips
34914	R1548	STERI-STRIP™ - 25x125 mm	25 bags of 4 strips

GIMA code	3M code	3M ELASTIC STERI-STRIP™ - sterile	Minimum order
34988	E4541	STERI-STRIP™ - 6x75 mm	50 bags of 3 strips
34989	E4542	STERI-STRIP™ - 6x38 mm	50 bags of 6 strips
34992	E4547	STERI-STRIP™ - 12x100 mm	50 bags of 6 strips
34993	E4548	STERI-STRIP™ - 25x125 mm	25 bags of 4 strips

## SUTURE STRIPS

• 34997 STERILE SUTURE STRIPS - 12 box of 8  
Sterile adhesive strips for cut and wound suture. Cut to measure. Dermatologically tested. It contains 15 small strips (3x75 mm) and 3 medium strips (6.4x80 mm). Multilingual box: GB, FR, IT, ES, DE.



34997

## SOOTHING PATCH

• 34830 PREVIDOL SOOTHING PATCH  
9x14 cm - pouch of 5  
Previdol is a Medical Device patch adjuvant in the treatment of pains in the joints and the muscular-skeletal system. It acts on the affected part, keeping the skin protected and helping to give relief in presence of pain. To improve the cutaneous tolerability of the patch, some plant extracts like Arnica Montana, Devil's Claw and Boswellia were inserted, as well as some essential oils of Mint and Menthol to give a pleasant fragrance. Box: GB, IT.



## 3M™ SKIN CARE SOLUTIONS - CAVILON™

A complete range of barrier products to protect the skin from body fluids and friction. Cavilon™ products create on the skin a highly breathable, long lasting transparent coating to prevent maceration and trauma. Alcohol-free, hypoallergenic and non irritating, can be used on broken skin and under any tapes and dressing.

GIMA code	3M code	3M CAVILON™	Minimum order
34974	3346E	Cavilon™ no sting barrier film - spray 28 ml	box of 12
34973	3346P	Cavilon™ no sting barrier film - spray 28 ml	box of 1
34977	3391G	Cavilon™ durable barrier cream 28 g	box of 1
34975	3392G	Cavilon™ durable barrier cream 92 g	1 dispenser
34976	9274	Cavilon™ continence care wipes	12 boxes of 8

3M CAVILON™ NO STING BARRIER FILM  
Up to 72 hours of protection for peri-wound and peri-ostomy skin.



3M CAVILON™ DURABLE BARRIER CREAM  
Zinc-oxide free barrier cream for continence care. Apply twice a day.

3M CAVILON™ CONTINENCE CARE WIPES  
«All in 1» wipes for cleansing, moisturizing and protecting the skin.



34976

34975

## ADHESIVE PLASTERS



GIMA code	HYPOALLERGENIC ADHESIVE PLASTERS	Minimum order
34809	Water resistant - 19x72 mm	2,000 (100 boxes of 20)
34814	Water resistant - 4 mixed shapes*	2,000 (100 boxes of 20)
34817	Sensitive skin - 5 mixed shapes**	3,200 (80 boxes of 40)

\*19x72, 25x72, 9x38 mm, Ø 22mm

\*\*19x72, 25x72, 9x38, 38x38 mm, Ø 22mm

## PLASTER DISPENSER



34828

34826

Size 230x120x38 mm

• 34826 PLASTER DISPENSER - with 2 refills (one each type)  
• 34827 REFILL 42 TEXTILE PLASTERS 19x72 mm - box of 6  
• 34828 REFILL 36 TEXTILE PLASTERS 25x72 mm - box of 6  
Dispenser for adhesive plasters ready for use. It allows operator to extract plaster with one hand and apply directly on the wound. Transparent cover protects plaster and shows residual quantities. Lockable and with fixing wall kit included.

## 3M™ TRANSPORE™ WHITE TAPE



### 3M™ TRANSPORE™ WHITE SURGICAL TAPE

Gentle tape with strong adhesion and easy bi-directional tear for dressing applications. Hypoallergenic and breathable. Good initial and long-term adhesion (72 hours), easy to handle with gloves, water-resistant.

Suggested applications:

- securing dressings to damp or dry skin
- taping fragile, at-risk skin
- anchoring tubes and devices
- when tape width must be customized
- scissors not needed, patch resectable with hands



GIMA code	3M code	3M™ TRANSPORE™ WHITE TAPE	Minimum order
34950	1534-0	TRANSPORE™ 13 mm x 9.14 m	box of 24
34951	1534-1	TRANSPORE™ 25 mm x 9.14 m	box of 12
34952	1534-2	TRANSPORE™ 51 mm x 9.14 m	box of 6

## 3M™ MICROFOAM™

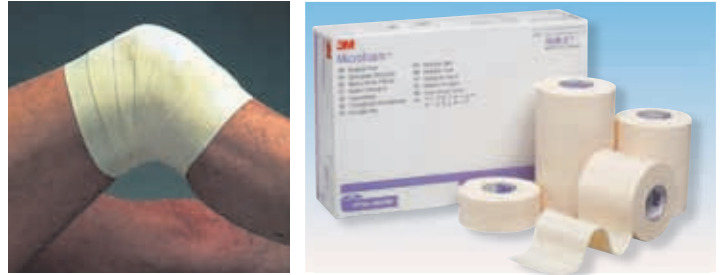

### 3M™ MICROFOAM™ SURGICAL TAPE

Highly conformable elastic foam tape that stretches for compression applications or securing dressings on challenging areas.

Multi-directional stretch to accommodate swelling and promote comfort.

Gentle, secure adhesion for anatomical areas with irregular contours.

Water-resistant.

Hypoallergenic and not made with natural rubber latex.

Quickly conforms to joints and skin folds.



GIMA code	3M code	3M™ MICROFOAM™	Minimum order
59710	1528-1	MICROFOAM™ 25 mm x 5 m	box of 12
59711	1528-2	MICROFOAM™ 50 mm x 5 m	box of 6

## SILK PLASTER ROLL

- 34787 SILK PLASTER ROLL

10 m x 2.5 cm - box of 12

- 34788 SILK PLASTER ROLL

10 m x 5 cm - box of 6

Silk surgical tape, white colour.

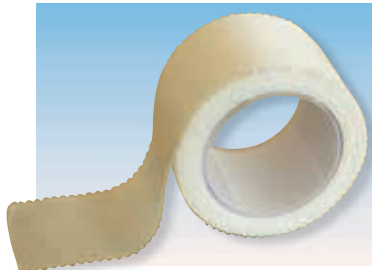

MADE IN ITALY



## SINGLEFIX® FINGER DRESSING

- 34810 SINGLEFIX® FINGER DRESSING - small - box of 100

- 34811 SINGLEFIX® FINGER DRESSING - medium - box of 100

- 34812 SINGLEFIX® FINGER DRESSING - adult - box of 100

Sterile finger dressing consisting of a cotton sheath and soft inner absorbent padding.

Convenient wrist knot fixing.

Easy to wear, it protects the injured finger, offering protection and comfort.



CE  
0373

34812



Multilingual instructions: GB, FR, IT, ES, PT, DE, HU, PL, BG, GR, RO, SE, SI, NO, NL, LT, LV, CZ, DK, FI, RU, TR, SK, EE, JP, Arabic.

## HYPOR POR PLASTER ROLLS



MADE IN ITALY



34806  
SKINTONE FABRIC

34804  
NON WOVEN - 5 m

34798  
NON WOVEN - 9.14 m

Each roll is supplied with a plastic roll cover except code 34798.

Multilingual box: GB, FR, IT, ES, DE.

### PLASTER ROLLS

Skintone fabric	Hypoallergenic Non woven	Size	Minimum order
34803	34804	5 m x 2.5 cm	box of 12 rolls
-	34798	9.14 m x 2.5 cm	box of 12 rolls
34806	34807	5 m x 5 cm	box of 6 rolls
34799	Shop Display: for showing up to 88 boxes (32 x 25 xh 63 mm)		

## NON WOVEN PAPER TAPE ROLL

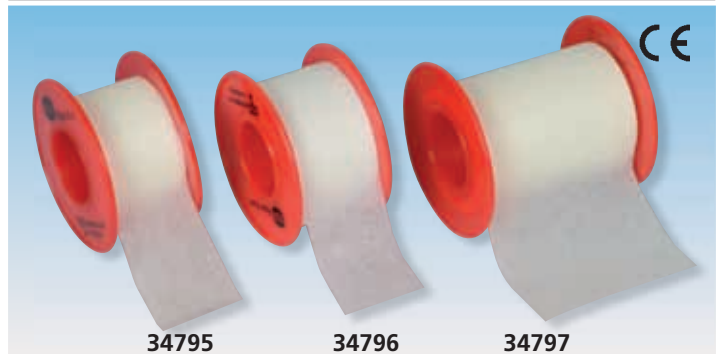

34795

34796

34797

Suitable for dressing application for sensitive skin areas of the body

GIMA code	NON WOVEN PAPER TAPE ROLL HYPOALLERGENIC ADHESIVE	Minimum order
34795	Tape roll h 25 mm x 5 m	box of 12 pcs
34796	Tape roll h 25 mm x 9.14 m	box of 12 pcs
34797	Tape roll h 50 mm x 9.14 m	box of 6 pcs



## 3M™ TAPES: MICROPORE™, MEDIPORE™, DURAPORE™, TRANSPORE™



A latex-free, hypoallergenic paper tape that is gentle to the skin and doesn't leave adhesive upon removal. Highly breathable and economical. Can be used on wet skin.



GIMA code	3M code	3M™ MICROPORE™ PAPER TAPES	Minimum order
34904	1530-0	MICROPORE™ - h 12.5 mm x 9.14 m	box of 24 rolls
34905	1530-1	MICROPORE™ - h 25 mm x 9.14 m	box of 12 rolls
34906	1530-2	MICROPORE™ - h 51 mm x 9.14 m	box of 6 rolls
34907	1530-3	MICROPORE™ - h 76 mm x 9.14 m	box of 4 rolls
34893	1530NP-1SD	MICROPORE™ - h 25 mm x 5 m	box of 1 roll



A silk tape with a latex-free, hypoallergenic adhesive that offers high strength and adhesion to skin.



GIMA code	3M code	3M™ DURAPORE™ SILK TAPES	Minimum order
34927	1538-0	DURAPORE™ - h 12.5 mm x 9.14 m	box of 24 rolls
34925	1538-1	DURAPORE™ - h 25 mm x 9.14 m	box of 12 rolls
34926	1538-2	DURAPORE™ - h 51 mm x 9.14 m	box of 6 rolls



Latex-free, hypoallergenic soft cloth tape. Gentle, breathable and easy-tear. Excellent cross and diagonal stretch to accommodate swelling and body movements

Available also with unique non-adherent pad.

GIMA code	3M code	3M™ MEDIPORE™ SOFT CLOTH TAPES and 3M™ MEDIPORE™ + PAD	Minimum order
34930	2991-1	MEDIPORE™ - h 50 mm x 10 m	box of 1 roll
34931	2991-2	MEDIPORE™ - h 100 mm x 10 m	box of 1 roll
34932	2991-3	MEDIPORE™ - h 150 mm x 10 m	box of 1 roll
34936	3562E	MEDIPORE™ + PAD - 5x7 cm	box of 50 pcs
34937	3566E	MEDIPORE™ + PAD - 10x10 cm	box of 25 pcs
34938	3569E	MEDIPORE™ + PAD - 10x15 cm	box of 25 pcs
34939	3570E	MEDIPORE™ + PAD - 10x20 cm	box of 25 pcs



Latex-free, hypoallergenic, transparent and perforated plastic tape that offers strong adhesion. Elastic and water-resistant.

GIMA code	3M code	3M™ TRANSPORE™ PLASTIC TAPES	Minimum order
34940	1527-0	TRANSPORE™ - h 12.5 mm x 9.14 m	box of 24 rolls
34941	1527-1	TRANSPORE™ - h 25 mm x 9.14 m	box of 12 rolls
34942	1527-2	TRANSPORE™ - h 51 mm x 9.14 m	box of 6 rolls

## BSN TAPES: LEUKOPOR®, LEUKOPLAST®, HYPAFIX®



The gentle tape for highly sensitive skin. For the fixation of dressings of all types and sizes. Non woven fabric and skin friendly adhesive mass.

GIMA code	BSN code	LEUKOPOR®	Minimum order
59501	02454-00	LEUKOPOR® 25 mm x 9.2 m	box of 12 rolls
59502	02455-00	LEUKOPOR® 50 mm x 9.2 m	box of 6 rolls



Highly adhesive tape for normal skin indicated when a strong adhesion is needed. Viscose fabric coated with traditional adhesive mass (natural rubber).

GIMA code	BSN code	LEUKOPLAST®	Minimum order
59504	01532-00	LEUKOPLAST® 25 mm x 5 m	box of 12 rolls
59505	01534-00	LEUKOPLAST® 50 mm x 5 m	box of 6 rolls



Non woven dressing retention sheet for the retention of dressings especially on highly contoured and frequently moved parts of the body. Conformable non woven fabric coated with a poliacyrylic adhesive mass



Pad not included

GIMA code	BSN code	HYPAFIX®	Minimum order
59510	71443-01	HYPAFIX® 50 mm x 10 m	box of 1
59511	71443-02	HYPAFIX® 100 mm x 10 m	box of 1
59512	71443-03	HYPAFIX® 150 mm x 10 m	box of 1
59513	71443-04	HYPAFIX® 200 mm x 10 m	box of 1

## HYPOR FILM ADHESIVE WATERPROOF DRESSING FOR FIXATION

Sterile adhesive dressing on transparent polyurethane film apt to fix catheters, gauzes, bandages and other dressings. The films acts as water and bacterial barrier. Permeable to air and water vapor, lets the skin breathe and avoids the risk of maceration. Individually packed. Extremely elastic substrate and highly conformable to sensitive areas. Reduces the risk of fluid leaking and infection. Multilingual box: GB, FR, IT, ES, DE. Medical Device Class I.

GIMA code	HYPOR FILM DRESSING FOR FIXATION - STERILE	Minimum order
58840	Hypor film 6 x 8 cm	box of 50 pcs
58841	Hypor film 10 x 12.5 cm	box of 50 pcs
58842	Hypor film 10 x 20 cm	box of 25 pcs
58843	Hypor film 10 x 25 cm	box of 25 pcs

CE 0546



Rounded edges to prevent the dressing from peeling off

Hypoallergenic acrylic adhesive, dermatologically tested

Protective liners easy removable with gloves

MADE IN ITALY

## ADHESIVE WOUND DRESSING I.V. FIXATION DRESSING



Soft transpirant non woven fabric coated with hypoallergenic adhesive polyacrylate. Central absorbent, non adherent pad in folded non woven fabric. X-ray transparent

GIMA code	STERILE - NON WOVEN ADHESIVE WOUND DRESSING HYPOALLERGENIC	Minimum order
34860	Sterile adhesive dressing 5x7 cm	box of 100 pcs
34861	Sterile adhesive dressing 8x10 cm	box of 50 pcs
34862	Sterile adhesive dressing 8x15 cm	box of 50 pcs
34849	Sterile adhesive dressing 10x25 cm	box of 25 pcs

CE 1370

• 34845 STERILE ADHESIVE DRESSING for cannula fixation - box of 50 pcs  
Designed for wide applications. Hypoallergenic acrylic adhesive, dermatologically tested. Size 8x5.8 cm. Wound pad size 2x1.5 cm. Multilingual box: GB, FR, IT, ES, DE. Medical Device Class I.



MADE IN ITALY

## TAILORED BANDAGES - SENSITIVE SKIN

Hypoallergenic extensible non woven adhesive dressing to be cut, with highly absorbent central wound pad. Recommended for sensitive skin. Multilingual box: GB, FR, IT, ES, DE. Medical Device Class I.

GIMA code	TAILORED BANDAGES		Minimum order
	Size	Wound pad	
34855	1 m x 6 cm	1 m x 2.4 cm	1 roll
34856	5 m x 6 cm	5 m x 2.4 cm	1 roll



MADE IN ITALY

## SURGICAL ADHESIVE DRESSINGS BWT ADHESIVE DRESSING



Sterile hypoallergenic adhesive dressing with central non-wound-sticking absorbant pad. Medical Device Class I.

DRESSING PHARMACY LINE - STERILE			
GIMA code	Size	Wound pad	Minimum order
34818	Surgical dressing 5x7.2 cm	2.8x3.8 cm	box of 5 pcs
58822	Surgical dressing 10x8 cm	5x4 cm	box of 5 pcs
34819	Surgical dressing 10x10 cm	5x5 cm	box of 5 pcs
58824	Surgical dressing 10x12.5 cm	5x7.5 cm	box of 5 pcs
34820	Surgical dressing 8x15 cm	3.8x10.5 cm	box of 5 pcs
DRESSING HOSPITAL LINE - STERILE			
58830	Surgical dressing 5x7.2 cm	2.8x3.8 cm	box of 50 pcs
34853	Surgical dressing 10x8 cm	5x4 cm	box of 50 pcs
58832	Surgical dressing 10x10 cm	5x5 cm	box of 50 pcs
34822	Surgical dressing 8x15 cm	3.8x10.5 cm	box of 50 pcs
58834	Surgical dressing 10x20 cm	5x15 cm	box of 50 pcs
58835	Surgical dressing 10x25 cm	5x20 cm	box of 25 pcs

CE 0546



Multilingual box: GB, FR, IT, ES, DE.



Sterile hypoallergenic adhesive dressing with central non-wound-sticking absorbant pad. Sterile impermeable protection of surgical wounds, superficial wounds, cuts and abrasions. Multilingual box: GB, FR, IT, ES, DE. Medical Device Class I.

DRESSING PHARMACY LINE - STERILE			
GIMA code	Size	Wound pad	Minimum order
58800	BWT dressing 5x7.2 cm	2.8x3.8 cm	box of 5 pcs
58801	BWT dressing 10x6 cm	6.5x3.5 cm	box of 5 pcs
58802	BWT dressing 10x8 cm	5x4 cm	box of 5 pcs
58803	BWT dressing 10x10 cm	5x5 cm	box of 5 pcs
58804	BWT dressing 10x12.5 cm	5x7.5 cm	box of 5 pcs
58805	BWT dressing 8x15 cm	3.8x10.5 cm	box of 5 pcs
DRESSING HOSPITAL LINE - STERILE			
34866	BWT dressing 5x7.2 cm	2.8x3.8 cm	box of 50 pcs
34867	BWT dressing 10x8 cm	5x4 cm	box of 50 pcs
34868	BWT dressing 8x15 cm	3.8x10.5 cm	box of 50 pcs

WATERPROOF

BWT material: transpiring, waterproof, thin

CE 0546

Round corners avoid dressing from coming off easily

Polyurethane film acts as an antibacterial barrier

MADE IN ITALY

## 3M™ INADINE™

**3M™ INADINE™ PVP-I NON ADHERENT DRESSING**  
Non adherent dressing, made of low adherent knitted viscose fabric impregnated with a polyethylene glycol (PEG) base, containing 10% Povidone Iodine. Designed to protect wounds even when they are infected, providing long-lasting antimicrobial effect against bacteria, mycobacteria, fungi, protozoa and viruses, including resistant species such as MRSA. Inadine dressing minimizes adherence to the wound bed, therefore reducing pain for patient and the risk of damage to the granulation tissue at dressing removal. Colour evolution from orange to white indicates loss of antiseptic efficacy and dressing needs to be changed. Weight: 3.25g. Indicated for ulcerative wounds, prevention of infection in minor burns, traumatic skin loss injuries and heavily infected wounds.



Latex free. Individually packed in aluminium pouch



59576

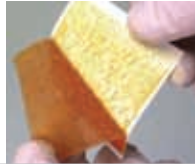

Gamma ray sterilization



GIMA code	3M™ code	3M™ INADINE™	Minimum order
59575	P01481	Inadine™ 5x5 cm	box of 25
59576	P01491	Inadine™ 9.5x9.5 cm	box of 10

## 3M™ KERRAMAX™ CARE

**3M™ KERRAMAX™ CARE SUPER-ABSORBENT DRESSING**  
The unique wicking layer distributes fluid both horizontally and vertically throughout the dressing, utilizing the full absorption capacity. Exu-Safe™ Technology, built into the dressing core, is an advanced method of absorbing high level of exudate from wounds, including bacteria and MMPs, creating an optimal environment for wound healing. It protects delicate wound tissue and surrounding, helping to reduce the risk of maceration, even under compression. Its heat-sealed border prevents exudate leakage. It can be left in place for up to 7 days. Absorption capacity: 0.95 g/cm². Indicated for: pressure injuries, venus leg ulcers and diabetic foot ulcers.



Latex free

Ethylene oxide sterilization



59580



Soft, conformable, foldable



GIMA code	3M™ code	3M™ KERRAMAX™ CARE	Minimum order
59580	PRD500-050	Kerramax™ Care 10x10 cm	box of 10
59581	PRD500-100	Kerramax™ Care 13.5x15.5 cm	box of 10
59582	PRD500-120	Kerramax™ Care 10x22 cm	box of 10
59583	PRD500-240	Kerramax™ Care 20x22 cm	box of 10
59584	PRD500-380-B10	Kerramax™ Care 20x30 cm	box of 10

## OCULAR ADHESIVE OCCLUSIVE BANDAGES

100% polyester extensible nonwoven occlusive fabric protection. Suitable for safe and comfortable dressing, the central swab has a protective action and the hypoallergenic acrylic adhesive is suitable for sensitive eye skin area. Individually packed. Medical Device Class I. Multilingual box: GB, FR, IT, ES, DE.



Polyethylene layer for an atraumatic removal

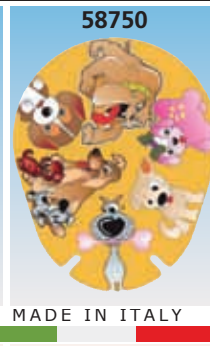

MADE IN ITALY

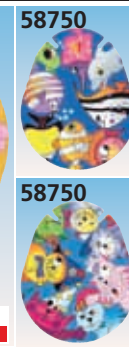

OCULAR ADHESIVE OCCLUSIVE BANDAGES					
GIMA code	Model	Colour	Size	Wound pad	Minimum order
58750	Regular Kids	patterned	7.2x5.7cm	4.9x3.2 cm	box of 21*
58751	Junior	skin	6.0x4.8 cm	3.8x2.6 cm	box of 21
58752	Regular	skin	7.2x5.7cm	4.9x3.2 cm	box of 21
58753	Large	skin	8.0x5.7cm	4.9x3.2 cm	box of 21

\*Mixed patterns: 7 pcs x 3 patterns

## EYE DRESSING

• **34848 OCULAR ADHESIVE EYE DRESSING**  
Sterile, extremely absorbent ocular dressing on hypoallergenic permeable adhesive backing. White soft polyester non woven suitable for a safe and comfortable eye medication. Medical Device Class I. Multilingual box: GB, FR, IT, ES, DE.



MADE IN ITALY

STERILE ADHESIVE EYE DRESSING			
GIMA code	Size	Wound pad	Minimum order
34848	6.5x9.5 cm	3.8x6.6 cm	box of 10

## NaCl 0.9% B-BRAUN STERILE IRRIGATION SOLUTIONS



GIMA code	B-BRAUN code	B-BRAUN	Minimum order
36550	3570310	B-BRAUN ECOLAV® - 30 ml	box of 100
36551	3570350	B-BRAUN ECOLAV® - 100 ml	box of 20
36552	3570380	B-BRAUN ECOLAV® - 250 ml	box of 20
36553	3570410	B-BRAUN ECOLAV® - 500 ml	box of 10
36554	3570110	B-BRAUN ECOTAINER® - 250 ml	box of 12
36555	3570130	B-BRAUN ECOTAINER® - 500 ml	box of 10
36558	3513576	B-BRAUN OMNIFLUSH® - 10 ml	box of 100

### ECOLAV®

The spray nozzle of Ecolav® allows a precise and direct irrigation of the target area by simply applying a slight pressure on the container, helping optimize the time for irrigation processes. Multilingual label: GB\*, FR, IT, ES, DE, PT, NL. \*Excluded 36551

### ECOTAINER®

Suggested for quick irrigation with high volume of solution. Multilingual label: GB\*\*, FR, IT, ES, DE, PT, NL, DK\*\*, FI\*\*, NO\*\*, SE\*\*. \*\*Only 36554

### COMPOSITION - ECOLAV and ECOTAINER

1,000 ml solution contain: sodium chloride 9 g, water, injection electrolytes: mmol/l Na<sup>+</sup> 154 Cl<sup>-</sup> 154

### B-BRAUN OMNIFLUSH®

**Prefilled flush syringe 10 ml with NaCl 0.9% - EM-3513576**  
The Omniflush® syringe is designed specifically to minimize unintended blood reflux into the catheter lumen thus reduces the risk of catheter blockage. With Omniflush® the fluid amount used for flushing can be reduced to the required minimum. For flushing of all intravenous accesses. Multilingual manual and label:

GB, FR, IT, ES, DE, PT, PL, CZ, BG, DK, EE, FI, GR, HU, LT, LV, NL, NO RO, SK, SI, SE, TR.



36558

## 3M™ SOLUTIONS FOR CHRONIC WOUNDS



### TEGADERM™ HYDROCOLLOID

Sterile hydrocolloid dressing for low to moderate draining wounds. Also available in sacral shape with highly breathable waterproof border.

GIMA code	3M code	3M™ TEGADERM™ HYDROCOLLOID	Minimum order
34968	90002	HYDROCOLLOID™ 10x10 cm square	box of 5
34969	90007	HYDROCOLLOID™ 16x17 cm sacral	box of 6



### TEGADERM™ ALGINATE

High integrity, gel forming alginate dressing for moderate to heavily exuding wounds. Compact and comfortable.

### TEGADERM™ ALGINATE AG

Antimicrobial, highly absorbent wound dressing with calcium alginate, carboxymethyl cellulose and ionic silver complex. To prevent and treat wound infections.

GIMA code	3M code	3M™ TEGADERM™ ALGINATE and ALGINATE AG	Minimum order
34964	90112	TEGADERM™ ALGINATE - 10x10 cm	box of 10
34965	90312	TEGADERM™ ALGINATE AG - 10x10 cm	box of 10



### 3M™ TEGADERM™ HIGH PERFORMANCE FOAM

Sterile, multi-layer foam dressing that combines high absorbency with high breathability to reduce the risk of wound maceration. Well suited for changing levels of exudate to maintain moisture balance for optimal wound healing. Highly breathable and waterproof, also available in heel/elbow shape with adhesive border and simplified application system.

GIMA code	3M code	3M™ TEGADERM™ FOAM - non adhesive or adhesive dressing	Minimum order
34954	90601	TEGADERM™ FOAM - 10x10 cm	box of 10
34955	90604	TEGADERM™ FOAM - 9x9 cm for tracheostomy	box of 10
34957	90619	TEGADERM™ FOAM adhesive for heel and elbow - 14x14 cm	box of 5



### TEGADERM™ HYDROGEL

Preservative-free hydrogel wound filler, easy to apply. Formulated to help providing a moist wound healing environment. Single use tube.



GIMA code	3M code	3M™ TEGADERM™ HYDROGEL	Minimum order
34972	91110	TEGADERM™ HYDROGEL 15 g	box of 10

## HYPOR STERILE POLYURETHANE FOAM DRESSING

### HYPOR STERILE POLYURETHANE FOAM DRESSING

Sterile hydrophilic polyurethane foam is indicated for the treatment of non-infected chronic or acute wounds, moderate to heavily exuding.

The dressing may be used during the healing process on pressure ulcers, leg and foot ulcers, diabetic ulcers and surgical wounds.

- high vertical absorption and retention capacity - minimize the risk of maceration
- semipermeable barrier - lets the skin breathe
- water and bacteria barrier - reduces the risk of infection
- soft, elastic and extremely conformable



Hypor Foam can stay in place for 3-4 days and up to a maximum of 7 days. Individually packed. Medical Device Class IIB

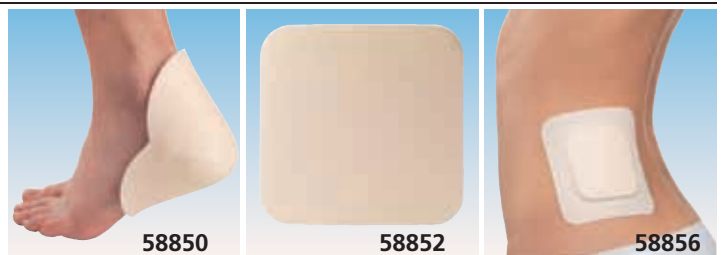

Anatomical shape. Quick and simple to use. Provides cushioning and pressure relief.

Provides cushioning protection

MADE IN ITALY

GIMA code	HYPOR FOAM HEEL - NON ADHESIVE	Minimum order
58850	HYPOR FOAM heel	box of 5
HYPOR FOAM PAD - NON ADHESIVE		
58852	HYPOR FOAM pad 5x5 cm	box of 10
58853	HYPOR FOAM pad 10x10 cm	box of 10
58854	HYPOR FOAM pad 15x15 cm	box of 10

GIMA code	HYPOR FOAM DRESS - ADHESIVE	Size	Wound pad	Minimum order
58856	HYPOR FOAM DRESS	7.5x7.5 cm	4.5x4.5 cm	box of 10
58857	HYPOR FOAM DRESS	12.5x12.5 cm	7.5x7.5 cm	box of 10

## HYPOR DERM STERILE HYDROCOLLOID DRESSING

### HYPOR DERM STERILE HYDROCOLLOID DRESSING

Sterile Hypor Derm is indicated for the treatment of non-infected chronic or acute ulcers, lightly to moderate exuding wounds, superficial abrasions and minor burns (two thicknesses available depending on the state of the wound).

Maintains the ideal moist wound environment for granulation and epithelialization.

- semi-permeable barrier, lets the skin breathe
- water and bacteria barrier - reduces the risk of infection
- self-adhesive
- turns into gel absorbing the exudates and preventing fluids leaking
- moulds itself to the wound shape, conforms to body contours
- replace every 3-4 days

Individually packed. Medical Device Class IIB

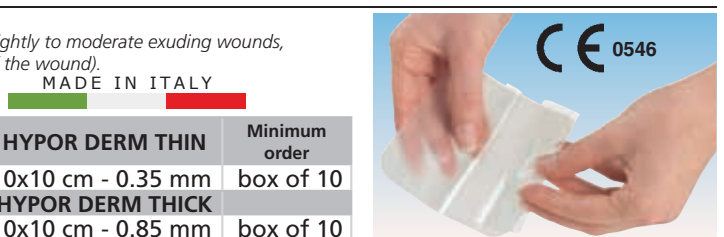

MADE IN ITALY

GIMA code	HYPOR DERM THIN	Minimum order
58859	10x10 cm - 0.35 mm	box of 10
HYPOR DERM THICK		
58860	10x10 cm - 0.85 mm	box of 10

## HYPOR SORB PURE CALCIUM ALGINATE DRESSING

### HYPOR SORB PURE CALCIUM ALGINATE DRESSING

Indicated for the treatment of chronic or acute moderate to highly exuding wounds and lesions. It can be applied on wounds with active infection, under medical supervision. Maintains the ideal moist wound environment for granulation and epithelialization.

- microfibre of soft and conformable pure calcium alginate with haemostatic properties
- absorbs up to 20 times its own weight
- turns fast into gel absorbing the exudates and preventing fluids leaking
- moulds itself to the wound shape, conforms to body contours
- replace every 3-4 days

Individually packed. Medical Device Class IIB



MADE IN ITALY

GIMA code	HYPOR SORB	Minimum order
58863	HYPOR SORB 10x10 cm	box of 10

## 3M™ TEGADERM™ DRESSINGS



**3M™ TEGADERM™**  
Transparent, sterile waterproof dressing. Highly breathable.  
Frame style for easy application also available in non-sterile roll.



GIMA code	3M code	3M TEGADERM™ FILM	Minimum order
34894	1623W	TEGADERM™ - 6x7 cm* - sterile <i>*For I.V. cannule</i>	box of 100
34900	1624W	TEGADERM™ - 6x7 cm - sterile	box of 100
34901	1626W	TEGADERM™ - 10x12 cm - sterile	box of 50
34902	1627	TEGADERM™ - 10x25 cm - sterile	box of 20
34903	1628	TEGADERM™ - 15x20 cm - sterile	box of 10
34899	1600A	TEGADERM™ - 10 cmx10 m non sterile	1 roll



**3M™ TEGADERM™ + PAD**  
Transparent, sterile waterproof dressing. Highly breathable.  
Frame style for easy application. With a non-adherent absorbent PAD.  
Ideal for surgical wounds.



GIMA code	3M code	3M™ TEGADERM™ + PAD	Minimum order
34895	3582	TEGADERM™ + PAD 5x7.2 cm - sterile	box of 50
34896	3586	TEGADERM™ + PAD 9x10 cm - sterile	box of 25
34897	3589	TEGADERM™ + PAD 9x15 cm - sterile	box of 25
34898	3591	TEGADERM™ + PAD 9x25 cm - sterile	box of 25

## 3M™ TEGADERM™ CHG

**3M™ TEGADERM™ CHG IV SECUREMENT DRESSING**  
Integrated I.V. dressing combines infection reduction with site visibility, catheter securement and breathability.  
Proven to reduce CRBSI and vascular catheter colonization.  
Immediate and continuous antimicrobial protection through integrated chlorhexidine gluconate gel pad, without requiring moisture to activate it.  
Designed to minimize catheter movement, it can be worn up to 7 days.  
Waterproof and sterile barrier to external contaminants (liquids, bacteria and viruses).

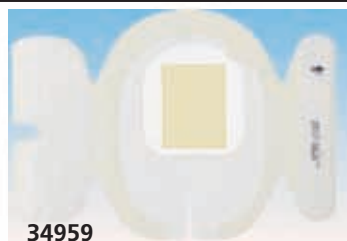

GIMA code	3M code	3M™ TEGADERM™ CHG IV SECUREMENT DRESSING	Minimum order
34959	1657R	TEGADERM™ CHG - 8.5x11.5 cm	box of 25
34960	1658R	TEGADERM™ CHG - 10x12 cm	box of 25

## 3M™ TEGADERM™ PICC/CVC

**3M™ TEGADERM™ PICC/CVC ADVANCED IV FIXATION DRESSING**  
Waterproof transparent film which provides a barrier against external contaminants (liquids, bacteria and viruses).  
The pre-formed plastic fastener is integrated on a breathable base with a silicone adhesive, that can be repositioned and easily removed from the skin avoiding needle injuries.  
They allow for continuous monitoring of the IV insertion site.  
Designed to stay in place for up to 7 days. Suitable for fixation of peripherally inserted central catheter (PICC) and short-term central venous catheters (CVC).



GIMA code	3M code	3M™ TEGADERM™ PICC/CVC ADVANCED SECUREMENT DRESSING	Minimum order
34962	1837-2100	TEGADERM™ PICC/CVC - 8.5x11.5 cm	box of 20
34963	1877R-2100	TEGADERM™ PICC/CVC + CHG - 8.5x11.5 cm	box of 20

## 3M™ CUROS™ DISINFECTING CAPS

**3M™ CUROS™ DISINFECTING CAPS**  
3M™ Curos caps disinfect in 1 minute and protect needle connectors and Luer to help reducing the risk of contaminants from entering the catheter post-insertion, for up to 7 days if not removed. Caps twist on easily and stay securely in place, preventing contained alcohol (70% isopropyl alcohol) from spreading within patient's circulatory system. For single use only. Suitable for needle-free connectors (34980), male Luer (34981) and open female Luer (34982).

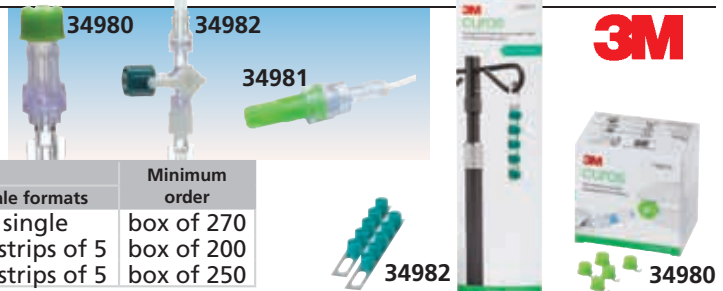

GIMA code	3M code	3M™ CUROS™ DISINFECTING CAPS		Sale formats	Minimum order
		Description	Connector		
34980	CFF1-270R	Curos™ caps	needle-free	single	box of 270
34981	CM5-200R	Curos™ Tips™ caps	male Luer	40 strips of 5	box of 200
34982	CSV5-250R	Curos™ Stopper™ caps	open female Luer	50 strips of 5	box of 250

## 3M™ VASCULAR ACCESS SOLUTIONS - 3M™ TEGADERM™ IV

A complete range of sterile, waterproof, highly-breathable transparent film dressings to protect IV sites from water, virus and bacteria. With antifriction backing and reinforced non-woven borders for longer wearing time and minimized catheter dislodgement risk.



**TEGADERM™ IV**  
A cost-effective solution for peripheral and central vascular lines with strong hold and gentle removal.



GIMA code	3M code	3M™ TEGADERM™ IV - STERILE	Minimum order
34945	1633	7x8.5 cm - for peripheral lines	box of 100
34946	1635	8.5x10.5 cm - for central lines	box of 50



**TEGADERM™ IV ADVANCED**  
A reinforced, 100% waterproof, advanced solution for better securement and longer wearing time.



GIMA code	3M code	3M™ TEGADERM™ IV ADVANCED - STERILE	Minimum order
34947	1683	6.5x7 cm for peripheral lines	box of 100
34948	1685	8.5x11.5 cm for central lines	box of 50

## ANTIBACTERIAL HAND CLEANING GEL

75% ALCOHOL



### ANTIBACTERIAL HAND CLEANING GEL

Antibacterial hand cleaning gel, cleans the hands and prevents the settlement of bacteria.

It is effective against bacteria, virus, fungi.

No need of water.

Gima range includes 4 sizes and 2 different flavours (neutral transparent, apple).

GIMA code	ANTIBACTERIAL HAND CLEANING GEL	Minimum order
36584	Antibacterial gel 100 ml tube - transparent	box of 30
36585	Antibacterial gel 100 ml tube - green - apple	box of 30
36589	Antibacterial gel 500 ml bottle* - transparent	box of 20
36594	Antibacterial gel 1 l bottle* - transparent	box of 18
36596	Antibacterial gel 5 l tank - transparent	box of 2**
33283	Dispenser pump for 36596	1

\*Each bottle includes dispenser pump \*\*Includes 1 empty bottle 250 ml and 1 nozzle

### CHEMICAL COMPOSITION

It contains: 75% Alcohol, Aqua (Water), Glycerin, Propylene glycol, Carbomer, Triethanolamine.

## MULTIUSI ALCOHOLIC GEL

Multiusi gel is an alcoholic gel for hands easy to use because it does not require water (Its special formula leaves the hands fresh, soft and pleasantly perfumed).

It contains +70% v/v ethyl alcohol.

It is indicated for specialists in the hospital and medical sector and also food operators. The ideal product to use between medical examinations since it guarantees maximum hygiene.

Multiusi gel is used for precautionary purposes in case of contact with people or objects that are potentially contaminated, replacing water and soap.

Multiusi gel is essential outside and on travelling.

GIMA code	MULTIUSI GEL	Minimum order
36647	Multiusi gel - 75 ml	box of 24
36648	Multiusi gel - 100 ml	box of 24
36643	Multiusi gel - 500 ml	box of 12
36644	Multiusi gel - 1000 ml	1
36649	Multiusi gel - 5 l	1
36656	Dispenser pump for 36643	1
36692	Dispenser pump for 36644	1

### CHEMICAL COMPOSITION

Ingredients: 70% Alcohol Denat, Aqua (Water), Acrylates/ C10-30 Alkylacrylate Crosspolymer, Triethanolamine, Propylene Glycol, Parfum (Fragrance), Benzophenone-4, Benzyl Benzoate, Citral, Limonene, Linalool



## MULTIUSI HAND WIPES - SACHETS AND FLOWPACK

- 36657 MULTIUSI HAND WIPES - box of 400 sachets
- 36658 MULTIUSI HAND WIPES - box of 240 (12 flowpacks of 20)

Multiusi hand wipes are new tissues which contain a hydroalcoholic solution with 70% (v/v) ethyl alcohol of cosmetic grade. Delicate on the skin, this handkerchief is indicated for the alcoholic friction of the hands, and the skin in general, at home or on travel.

It can be used for precautionary purposes or after coming into contact with potentially contaminated people or objects.

### CHEMICAL COMPOSITION

It contains: Alcohol Denat, Aqua (Water), Propylene Glycol, Parfum (Fragrance), Benzyl Benzoate, Citral, Limonene, Linalool



## HAND-WASH SYSTEM

- 36677 DOSASOAP NO-TOUCH HAND WASH SYSTEM - white Wall-mounted no-touch dispenser with photocell for antiseptics, convenient for detergents, liquid soaps and gels. A sensor detects hand movements and dispenses the product. It ensures a rapid and safe hand hygiene, without any contact with the dispenser. Suitable for 1 litre bottles (36630, 36632, 36644, 36595). Battery operated, it needs 4xAAA, not included.
- 36678 PUMP FOR DOSASOAP - spare



## FLOWPACK WIPES

### 36627 FLOWPACK 20 WIPES

Disinfectant detergent perfumed wipes for hands and body disinfection. Active against bacteria to guarantee hygiene and total protection. Suitable to fight against effects of perspiration, eliminating bacteria that cause bad smells. Good for children. Ready to use, they do not stain and do not grease.

Minimum order:  
1 display of 16 flowpacks with 20 wipes

Italian Health Ministry. Registration 12671

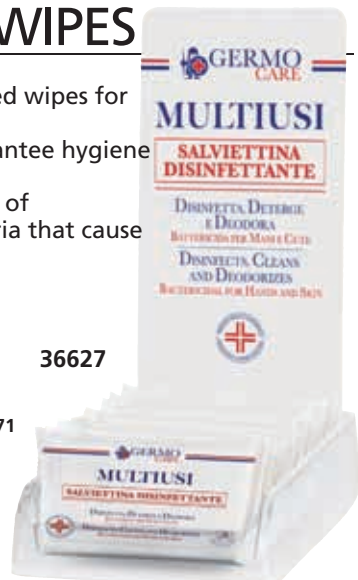

36627

MADE IN ITALY

## DISINFECTANT WIPES

### DISINFECTANT WIPES

MADE IN ITALY

#### 36625 tube of 100 wipes

Wipes active against bacteria, ideal for children, they do not burn. Indispensable at home, in the car, in sporting events.

Indicated for disinfection of:

- skin, before injections
- hands and body disinfection.

Instructions/label GB, IT.



36626

36625

### CHEMICAL COMPOSITION

100 g contain: Benzalkonium Chloride 0.5% O-phenilphenol 0.01%, Chamomile extract. Coformulants and water as needed to 100 g.  
Italian Health Ministry Registration 12671

## MEDICAL SOAP

### 36628 MEDICAL SOAP - sachet 5 ml - box of 500

### 36629 MEDICAL SOAP - 0.5 l - box of 12

### 36630 MEDICAL SOAP - 1 l

### 36690 DISPENSER PUMP

Antiseptic liquid for hands and skin disinfection. It is indicated for surgeon and medical staff's hands and also patient disinfection, before surgical operations. It reduces risk of cross-infections. It contains emollient substance, which make skin soft.

Label/instructions: GB, IT.

MADE IN ITALY



36628



36629



36630

### CHEMICAL COMPOSITION

100.0 g contain: Alkyl benzyl dimethyl ammonium chloride 0.50 g; O-phenilphenol 0.50 g; perfume; coformulants, deperated water q.s. to 100.0 g.  
Italian Health Ministry Registration 19570

## BARRIER CREAM - HANDS PROTECTION

### 36577 BARRIER CREAM - 75 ml - box of 12

### 36578 BARRIER CREAM - 500 ml

Dermoprotective hand cream with barrier effect, formulated with nourishing, moisturizing and emollient ingredients from biological agriculture (only 36577). It creates an invisible protection, restoring natural hydrolipidic balance and maintaining pH of the skin.

It is waterproof and protects from external environmental agents, irritations and dryness.

It also prevents redness, roughness, cracking and itching.

It avoids skin's maceration due to the use of gloves.

It doesn't leave residue and it's not greasy.

It is intended for both home and professional use.



36577

36578

MADE IN ITALY

## DENTAL PROTECTION

### 36650 GERMOXID MOUTHWASH - with chlorhexidine - 1 l

### 36651 GERMOXID MOUTHWASH - with chlorhexidine - 200 ml

Gerموxid mouthwash is characterized by its formulation with Chlorhexidine 0.2% designed to prevent plaque buildup and related inflammation such as gingivitis.

Enriched with Aloe vera extracts with natural soothing and refreshing actions.

Lack of alcohol avoids irritant effects on gums and unpleasant burning sensations.

It is suitable for the mouth hygiene after dentistry and for people who carry prosthesis or orthodontic appliances.

36651

MADE IN ITALY



36650

### CHEMICAL COMPOSITION

Aqua (Water), Glycerin, Sorbitol, Xylitol, Chlorhexidine Digluconate, Aloe Barbadensis Leaf Extract, Polysorbate 20, Allantoin, Sodium Benzoate, Aroma, Sodium Saccharin, CI 42051.

## STAND FOR GEL AND GLOVES

### 36676 STAND FOR HAND SANITIZER DISPENSER AND GLOVE BOX

Sturdy and resistant stand made of epoxy painted steel, black colour.

It can be positioned in any type of room.

Base disassembled with feet.

Sign holder

Holder (base 10x10 cm) for hand sanitizer dispenser (dispenser not included)

Holder for glove box (gloves not included)

36676

Base Ø 60 cm

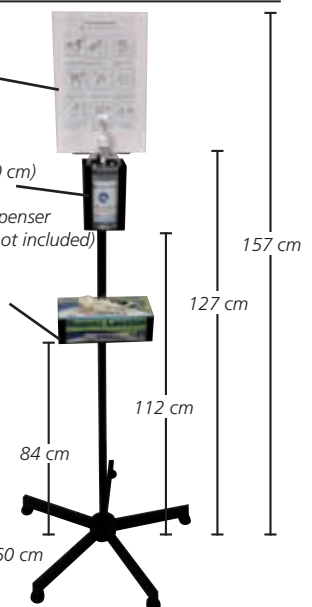

## ■ IODO-POVIDONE ANTISEPTIC

- 36614 IODO-POVIDONE ANTISEPTIC 125 ml
- 36608 IODO-POVIDONE ANTISEPTIC 500 ml
- 36619 IODO-POVIDONE ANTISEPTIC 1,000 ml

Wide spectrum disinfectant for the disinfection and cleaning of intact skin in hospital wards.

The range of action includes Gram<sup>+</sup> and Gram<sup>-</sup> germs.

Biocida PT-1 - IT/2020/00656/AUT.

Registered in Italy only.

We can evaluate registration in other countries in case of long term project. Label: GB, IT. Shelf life 24 months.



### CHEMICAL COMPOSITION

100 ml of solution contains: 2-Pyrrolidinone, 1-Ethenyl, Homopolimer with iodine (iodo-povidone 10% iodine), 10 g coformulants and water q.b. 100 ml



36614

36608

36619

## ■ NOVALCOL SKIN DISINFECTANT

- 36609 NOVALCOL - 250 ml - box of 12 bottles
- 36611 NOVALCOL - 1 l
- 36613 NOVALCOL - 3 l

Novalcol is a ready-to-use liquid disinfectant, indicated for skin disinfection.

It is suitable for hands, skin and injection points disinfection.

It is useful during assistance of sick people and contamination risks.

Do not use the product on wounded skin or mucous membranes.

It dries quickly, it doesn't stain nor irritates the skin.



### CHEMICAL COMPOSITION

Dimethyl ammonium Chloride	0.10 g
O-Phenylphenol	0.02 g
Coformulants, deperated water as needed to	100 g
Italian Health Ministry Registration 13428	



36609

36611

36613

## ■ HYDROGEN PEROXIDE



- 36604 OXYGENATED WATER (Hydrogen peroxide) - 250 ml - box of 12
- 36605 OXYGENATED WATER (Hydrogen peroxide) - 1 l - box of 12

Hydrogen peroxide (3% diluted solution) 10 volumes. Clear solution, colourless. Multilingual label: GB, FR, IT, ES.

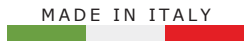

### CHEMICAL COMPOSITION

Hydrogen peroxide:	≥3% (10 vol.)
Water:	≤96.999%
Stabilizer:	0.001%

## ■ ALCOHOL PADS - SACHETS

- 36598 ALCOLPAD - box of 100 pads
- 36599 ALCOLPAD - carton of 10,000 (100 boxes of 100 pads)



Alcohol saturated pads with 70% isopropyl alcohol for skin preparation prior to injection. Bag size 50x50 mm, folded pad 32.5x30 mm, open pad 65x30 mm. Multilingual box/ instructions: GB, FR, IT, ES, PT, DE.

## ■ ALCOHOL SWABSTICKS

- 36603 ALCOHOL SWABSTICKS - box of 16
- Practical swabstick soak with isopropyl alcohol 70% ready for use. Comes in a protected convenient breakable stick shell with dimension 75x8 mm. Safe for the nurses who does not touch directly the stick neither the alcohol. Suitable for cleaning and disinfection of minor wound care, skin cleaning and disinfection before injection, infusion and transfusion.



Multilingual box and instructions: GB, FR, IT, ES

36603

## ■ ALCOHOL PADS - DISPENSER

- 36601 QUICKPAD DISPENSER
- Fleece pads saturated with 70% Isopropyl Alcohol. The tight fitting lid prevents evaporations. Size 50x50x80 mm contains 150 pads, size: 44x44 mm.

U.S. and International Patents FDA Reg. #8010920



150 ALCOHOL SWABS

36601



MADE IN ITALY

## SURGICAL SCRUB BRUSHES/SPONGES



36570

• **36570 SCRUB KIT - sterile - dispenser of 30 pcs**  
Sterile hand-cleaning hospital kit. It includes a scrub, a sponge and a plastic nail cleaner. Dry, without detergent. Sterilization method: ETO. Multilingual label (blister and dispenser): GB, FR, IT, ES, DE, PT, PL, NL, GR, RU, Arabic.



36571, 36572

• **36571 IODO-POVIDONE SCRUB KIT dispenser of 30 pcs - IT**  
Italian Health Ministry registration PMC 19531  
• **36572 IODO-POVIDONE SCRUB KIT dispenser of 30 pcs - Multilingual\***  
*\*Label: GB, FR, ES, DE, PT, NL, GR (blister and dispenser), PL, RU, Arabic (blister only), IT (dispenser only)*  
same as 36570 with solution of PVP Iodine 7.5 g in 100 ml, not sterile.



36573, 36574

• **36573 CHLOREXIDINA SCRUB KIT dispenser of 30 pcs - IT**  
Italian Health Ministry registration PMC 19575  
• **36574 CHLOREXIDINA SCRUB KIT dispenser of 30 pcs - Multilingual\***  
*\*Label: GB, FR, ES, DE, PT, NL, GR (blister and dispenser), PL, RU, Arabic (blister only), IT (dispenser only)*  
same as 36570 with solution of Chlorhexidine Gluconate 20% 4 g in 100 ml, not sterile.

All scrub kits are individually blistered in 30 pieces dispenser



36570



36571



36572



36573



36574

## PERFECTION BRUSHES



STERILIZABLE IN AUTOCLAVE

• **25715 PERFECTION BRUSHES**  
Nylon brushes for cleaning before and after operation. These brushes are autoclavable (at 100°C for not more than 5 minutes) and can be stored in any standard brush dispenser in hospitals. Resistant and reliable. Handle in PP. Size: 109x41x34 mm. Supplied in boxes of 12 units.

## SURGERY DISINFECTANT

• **36632 NEO STERIXIDINA SOAP - 1 l**  
• **36690 DISPENSER PUMP**  
Ready-to-use disinfectant liquid soap for hands and skin with antibacterial activity, based on Chlorhexidine Digluconate 4%. It can be used for surgeon and medical staff's hands and also patient disinfection, before surgical operations. It reduces the risk of cross-infection. It removes microorganisms and keeps bacteria flora at lowest level.  
Label in GB, IT.



36632 + 36690

4% CHLORHEXIDINE

MADE IN ITALY

### CHEMICAL COMPOSITION

100 g contain:  
Chlorhexidine digluconate 4 g - Coformulants  
- Deperated water as needed for 100g  
Italian Health Ministry registration 18980

## CHLORHEXIDINE DISINFECTION LINE



36634

- **36637 GERMOXID SPRAY DISINFECTION - 100 ml - box of 12**
- **36635 GERMOXID DISINFECTION - 250 ml - box of 12**
- **36636 GERMOXID DISINFECTION - 1,000 ml - box of 12**
- **36634 GERMOXID WIPE - 12 boxes of 10 wipes**
- **36638 GERMOXID WIPE - box of 400 wipes**

Ready-to-use disinfectant for skin that contains Chlorhexidine with long-lasting bactericidal action. Chlorhexidine has a proven broad-spectrum effectiveness against Gram<sup>+</sup> and Gram<sup>-</sup> bacteria. Thanks to its structure, Chlorhexidine can be easily absorbed by the skin. Safe for medical operators thanks to its high epidermis compatibility, it neither irritates the skin nor stains or burns. Available in 3 versions: liquid (250 or 1,000 ml), spray (for quick and efficient action) or wet wipes with chlorhexidine.

MADE IN ITALY

### CHEMICAL COMPOSITION

100,0 g of solution contain: Chlorhexidine digluconate 1,0 g; soluble bergamot essential oil and deperated water q.s. to 100,0 g. Contain: limonene, Linalool.  
Italian Health Ministry registration 11571



Label in GB, IT

36636

36635

36637

36638

## BARRYCIDAL "30 PLUS": A WIDE-SPECTRUM DISINFECTANT

- 35761 BARRYCIDAL "30 PLUS" - diluted 10% - bottle 1 l - box of 12 bottles
  - 35760 DISPENSER PUMP for 35761
  - 35762 BARRYCIDAL "30 PLUS" - diluted 10% - tank 5 l
- Ready for use 1 or 5 l bottle with 10 cc measurer cap.
- 35766 BARRYCIDAL "30 PLUS" - concentrate, to be diluted - bottle 1 l
  - 35767 BARRYCIDAL "30 PLUS" - concentrate, to be diluted - tank 5 l

Barrycidal 30 Plus is a water-based solution with glutaraldehyde and phenols, suitable to cleanse and disinfect surgical instruments and thermosensitive, non-autoclavable endoscopes, with good property to dissolve blood and organic traces. Colourless liquid emulsion. The product diluted by 10% is not classified as hazardous, according to Regulation 1272/2008 (CLP). Medical Device Class IIb - Directive 93/42 EEC. **Tested action-spectrum in "clean" conditions:** bactericide (EN 13727 and EN 14561), fungicide (Candida Albicans, Aspergillus Niger; EN 13624 and EN 14562), mycobactericidal and tuberculocidal (Mycobacterium Avium, Mycobacterium Terrae; EN 14348 and EN 14563), virucidal (EN 14476). 30 Plus concentrate acts in 15 min. if diluted by 5%, 60 min. if diluted by 2.5%. Diluted by 2.5% results in 9 l of ready to use product. Shelf life: 36 months.



35762 35761 35767  
Label: GB, IT **MADE IN ITALY** 0068 35766

### CHEMICAL COMPOSITION

**30 Plus concentrate:** 100 ml contain: glutaraldehyde (<2%), 2-benzil-4-chlorophenol 4.5%, 2-phenylphenol 7%, coformulants and purified water.  
**30 Plus standard:** contains less than 0.2% at 5% dilution glutaraldehyde, phenols, surfactants.

## DISINFECTANT POWDER

- 36639 GERMOCID PERACETIC POWDER - bag 16 g - box of 50 bags
- 36640 GERMOCID PERACETIC POWDER - box of 500 g

Cold sterilizer disinfectant: the peracetic acid which forms from the reaction of sodium percarbonate and tetracetylethylendiammine (obtained after dissolving the product into water) carries on an efficacious biocidal action against **spores, virus** (included HIV, HBV, HCV), **bacteria, mycobacteria** and **fungi**. At the concentration of 1.6% of product, it carries on **sterilization in 10 minutes**.

Active in 15 minutes from dissolution and remains active for max 24 hours. Suitable for a cold rapid sterilization and disinfection of endoscopes, surgical and dental instruments, transducer, etc.

Also active in presence of organic materials (previously clean the device with suitable detergent, better with enzymatic base). Suitable for automatic washing machines. No environmental impact: once in contact with discharge water, it degrades immediately into acetic acid, water, oxygen.



0546

MADE IN ITALY

### CHEMICAL COMPOSITION

Peracetic acid precursors and coformulants.

36640

Label/instruction: GB, FR, IT

## GERMOCID BASIC

- 36615 GERMOCID BASIC - 750 ml
- Alcohol-based disinfectant cleaner for non-invasive medical devices.

- **Disinfectant action:** the association between Chlorhexidine and Quaternary ammonium Salt and the high alcoholic content guarantees a large action spectrum towards:

- Gram<sup>+</sup> and Gram<sup>-</sup> bacteria, fungi (yeasts and molds) and viruses (HIV, HBV, HCV included) in **5 minutes**
- mycobacteria (TBC included) in **60 minutes**.

Strong detergent power and fast evaporation. It is not de-activated by organic substances.

- **Bactericide, virucide and fungicide activity.**

- 36691 VAPORIZER - optional

MADE IN ITALY

ALCOHOL BASED

0546



36615

Label/instruction: GB, FR, IT

### CHEMICAL COMPOSITION

100 g of product contain: Chlorexidine digluconato 0,1 g; Benzalkonium Chloride 0,1 g; Ethyl Alcohol 45,0 g; Isopropyl Alcohol 15,0 g as needed to 100 g  
Product form: Colourless liquid. No added perfume

## BOXES FOR COLD STERILIZATION



35770

- 35770 STERILIZATION BOX - 1.5 l (internal: 10x25.5xh 7.5 cm)
  - 35772 STERILIZATION BOX - 3 l (internal 18.3x29xh 9 cm) - autoclavable
- Useful plastic box, with removable internal perforated instrument tray, developed for cold sterilization of medical instruments.



35772 autoclavable

MADE IN ITALY

## ENZYME-BASED DETERGENT

- 36618 ENZYME-BASED DETERGENT - 3 l

Medical device enzymatic based detergent for invasive surgical instruments. This clear liquid detergent is very useful to improve the cleaning of orthodontic and surgical instruments, glassware, plastic and metal objects. Also suitable for ultrasound cleaners. Dilute 0.6-10% in 1 litre warm water, immerse the instruments for 10 minutes and rinse.

Label/instruction: GB, FR, IT.

MADE IN ITALY



36618

### CHEMICAL COMPOSITION

100 g contain: proteolytic enzymes 0.5 g, non-ionic surfactant agents 10-15 g, coformulants, water as needed to 100 g

## GERMOCID WIPES

- 36668 GERMOCID WIPES - alcohol 15% - 220 wipes
- 36669 GERMOCID BASIC WIPES - alcohol 60% - 220 wipes

Suitable for cleaning and disinfection of non-invasive medical devices and surfaces in medical and dental offices.

**Disinfectant action:** fast and effective against Bacteria Gram<sup>+</sup> Gram<sup>-</sup>, Yeasts, Moulds, Fungi, Tuberculous Mycobacteria (TBC), Viruses (included HIV - HBV - HCV). It is not inactivated by organic residuals. High detergent power and quick evaporation.

The low content of alcohol 15% (36668) allows a safe use without

damaging materials.



Wipe size: 140x26 mm

**36668: 15% ALCOHOL**  
**36669: 60% ALCOHOL**

MADE IN ITALY

### CHEMICAL COMPOSITION

100,00 g contain:

**36668** Benzalkonium Chloride 0,50 g; O-phenilphenol 0,02 g; Isopropyl Alcohol, Ethanol, coformulants, deperated water q.s. to 100,00 g;

**36669** Chlorhexidine Digluconate 0,1 g; Benzalkonium chloride 0,1 g; Ethanol 45,0 g; Isopropyl Alcohol 15,0 g; Coformulants, deperated water q.s. to 100,0 g.



## GERMOCID TEC

- 36681 GERMOCID TEC - 750 ml
  - 36682 VAPORIZER - optional
- Foaming disinfectant cleaner for non-invasive medical devices used in tattoo studios, clinics, hospitals, beauty shops. Suitable for **sensitive surfaces** where you can't use alcohol based disinfectants. It is a safe product, it dries quickly, does not stain and leaves no streaks. Ready-to-use spray that cleans and, thanks to the synergic action of the Quaternary Ammonium Salt with Orthophenylphenol, disinfects from bacteria, yeasts, fungi, moulds, TBC, viruses (including Adenovirus, HIV, HBV and HCV). Label/instruction: GB, FR, IT.

**SENSITIVE SURFACES**



36681  
+  
36682



MADE IN ITALY

### CHEMICAL COMPOSITION

100 g of product contain: 2% Benzalkonium Chloride; 0.2% O-phenilphenol; coformulants; deperated water as needed to 100 g; Product form: Variable colour (light yellow - pale green) liquid with citron perfume

## DISINFECTANT SPRAY

- 36620 GERMOCID DISINFECTANT SPRAY - 400 ml
- Disinfectant spray with bactericidal and virucidal on enveloped viruses power.

Disinfects and deodorizes surfaces and objects of crowded and smoky areas (hospitals, classrooms, examination and surgery rooms, bathrooms, cars). Instructions in GB, FR, IT.

MADE IN ITALY

**FOR ROOMS AND SURFACES**

### CHEMICAL COMPOSITION

100 g contain: O-phenilphenol 0.02 g; benzalkonium chloride 0.1 g. Coformulants and propellants as needed to 100 g. Italian Health Ministry registration 7604



36620

## GERMOCID TABS

- 36622 GERMOCID TABS CHLORINE TABLETS - 1 kg
- White round effervescent chlorine tablets for cleaning and deodorizing. The dilution of 1 tablet in 7-8 litres of water or 2 tablets if you need stronger action allows to hygienize rubber, plastic or glass. Germocid tabs can be used for many other purposes: wc sanitizing, dishwasher, floor cleaning and also for mopping bars, restaurants, hospitals. Rinsing required. Packed in 1 kg jar, containing approx: 333 tabs. Label/instruction: GB, FR, IT.

MADE IN ITALY



36622

## ENVIRONMENT DISINFECTANT

- 36616 ENVIRONMENT DISINFECTANT - bottle of 1 litre
  - 36617 ENVIRONMENT DISINFECTANT - tank of 3 litres
- Concentrated liquid detergent-disinfectant for environments. Dilute it in water to a ratio of 0.5% for the disinfection and the cleaning of surfaces,

counter, tiles, floors, sanitary fixtures, also using floor-washing machines. Suitable in large areas (hospitals, clinics, rest homes, gyms...).

- **Disinfectant action:** wide protection against viruses, fungi, bacteria Gram<sup>+</sup> and Gram<sup>-</sup>.

- **Detergent action:** contains non-ionic surface active agents to enhance the cleaning of surfaces.

Label/instruction: GB, FR, IT.

MADE IN ITALY



36617

36616

### CHEMICAL COMPOSITION

100 g of product contain: Quaternary ammonium compound 10 g  
Isotiazolinone magnesium chloride 0.2 g  
Coformulants and deperated water 100 g

Appearance: pale yellow liquid Smell: citrus

Biodegradability: detergent according to reg. CE n° 648/2004

Italian Health Ministry authorization N° 9658

## GERMOCID INODORE

- 36664 GERMOCID INODORE - bottle 1 l
  - 36665 GERMOCID INODORE - tank 5 l
- Concentrated solution with a rapid and effective action as detergent and disinfectant.

It is active against Gram<sup>+</sup> and Gram<sup>-</sup> bacteria, fungi, mycobacteria and viruses (Adenovirus, HIV, HBV, HCV). Rapid and practical cleansing and disinfection of all surfaces of non-invasive medical devices such as beds, litters, masks and various equipment (desks, armrests, handles, etc.) usually in use at medical or dental surgeries, hospitals, beauty centers. It disinfects, degreases and cleanses, does not stain and does not leave halos. Also suitable for alcohol-sensitive surfaces and materials. Class IIa Medical Device in compliance with Directive 93/42/EEC. Label/instruction: GB, FR, IT.

MADE IN ITALY



36665

36664

### CHEMICAL COMPOSITION

100,0 g of product contain: Benzalkonium Chloride 10,0 g; Orthophenylphenol 1,0 g; coformulants, deperated water q.s. to 100,0 g

## GIMA AIR CLEANER - BIOLOGICAL AIR TREATMENT



• **36510 GIMA AIR CLEANER**  
 GIMA Air Cleaner is the most effective mean for destroying microorganisms in the air. It protects your health and that of employees and patients, through a system exclusively dedicated to biological air treatment. Ultraviolet radiation, at controlled short wavelength (UVC 254nm), blocks reproductive capacity of microorganisms by altering their chromosomes. It can be used continuously even in the presence of people, without any risk. The device works on the basis of a closed-loop, forced ventilation system: the air passes through a dust filter and comes into direct contact with UV-C radiations lamps which perform the maximum germicidal action. The air is expelled carrying out microbiological abatement. Not intended for surfaces sterilization. Multilingual manual: GB, FR, IT, ES, PT, DE.

• **36511 STAND FOR AIR CLEANER - optional**  
 • **36512 SET OF 4 LAMPS - spare**  
 • **36513 ANTI DUST FILTER - spare**

### TECHNICAL SPECIFICATIONS

Operation mode:	continuous
Air treatment rate:	120 m <sup>3</sup> /h
Noise level:	32 dB
Lamps:	n. 4 UV-C tubes 25W G13T8 (7 W UVGI)
Lamp life:	9,000 hours (1 year: 24 hours x 365 dd)
Wavelength:	253,7 nm
Ultraviolet energy:	69 µW/cm <sup>2</sup> at 1 m (per lamp)
UV-C radiation external emission:	none
Power supply voltage - frequency - power:	230 V-±10% - 50 Hz - 150 W

**90% AIRBORNE BACTERIAL ELIMINATION IN 3 HOURS**

**120 m<sup>3</sup>/h HIGH TREATMENT CAPACITY**

*No ozone dispersion*  
 Safe for people  
 Absolutely risk-free for humans since there is no leakage of UV-C radiations from the device.

*Continuous disinfection for constant protection.*  
 Air in any environment is treated and purified continuously, in the presence of operators.

*Programmable*  
 Maximum protection according to your needs. Programme Air Cleaner to switch on a couple of hours before your arrival until the end of the day.

*No maintenance*  
 Air Cleaner uses simple dust filter because the germicidal action is guaranteed by the lamps

MADE IN ITALY

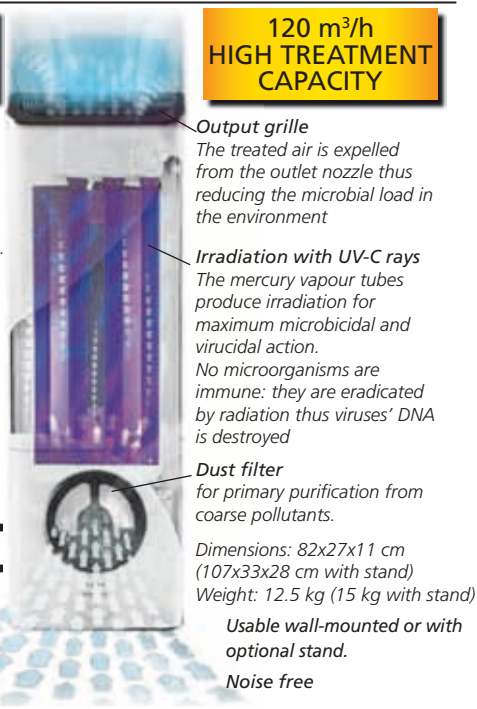

**Output grille**  
 The treated air is expelled from the outlet nozzle thus reducing the microbial load in the environment

**Irradiation with UV-C rays**  
 The mercury vapour tubes produce irradiation for maximum microbicidal and virucidal action. No microorganisms are immune: they are eradicated by radiation thus viruses' DNA is destroyed

**Dust filter**  
 for primary purification from coarse pollutants.

Dimensions: 82x27x11 cm (107x33x28 cm with stand)  
 Weight: 12.5 kg (15 kg with stand)

Usable wall-mounted or with optional stand.

Noise free

## DISINFECTANT SPRAY

• **36623 DISINFECTANT SPRAY - 400 ml**  
 Disinfectant spray quickly eliminates fungi, bacteria, viruses and allergens, performing an effective deodorant action. Useful to disinfect and deodorize soft fabrics and surfaces such as sofas, armchairs, chairs, cushions, mattresses, rugs, curtains, carpets or high passage areas such as dressing rooms, waiting rooms, classrooms, canteens, gyms, public toilets. Label: GB, IT.

**Disinfectant action:** complete action spectrum against Gram-positive and Gram-negative bacteria and fungi. Virucidal activity (Enveloped viruses, HIV, HBV, HCV, Coronavirus): EN14476. It does not wet, does not stain, does not leave residues and does not damage fabrics and materials.

**FOR FABRICS, ROOMS AND SURFACES**



## AIR CONDITIONING DISINFECTANT

• **36624 CLIMACARE DISINFECTANT SPRAY - 400 ml**  
 Disinfectant spray active on bacteria (included Legionella), viruses and fungi. Specially formulated for the disinfection of air conditioning systems, splits and heat pumps, Climacare spray acts directly on the microorganisms responsible for respiratory diseases. Used regularly it prevents microbial contamination first inside the air conditioning systems and then in the rooms.

**Disinfectant action:** complete action spectrum against Gram-positive and Gram-negative bacteria and fungi. Virucidal activity (Enveloped viruses, HIV, HBV, HCV, Coronavirus): EN14476. It does not damage the materials, plastic, resins, metals, special adhesives. It does not stain. Label: GB, IT.

**FOR AIR CONDITIONING SYSTEMS**



**CHEMICAL COMPOSITION**  
 100,00 g contain: Benzalkonium chloride 0,10 g; Biphenyl-2-ol 0,02 g; Propan-2-ol; Parfum; Propellants as needed to 100,00 g.  
 Product form: perfumed spray. Italian MOH Registration No. 13.431

**CHEMICAL COMPOSITION**  
 100,00 g of product contain: Benzalkonium chloride 0,10 g; O-phenylphenol 0,02 g; Isopropyl alcohol; parfum, propellants as needed to 100,00 g.  
 Product form: perfumed spray. Italian MOH Registration No. 7.604

## OFFICE DISINFECTANT - SPRAY

• **36621 OFFICE SPRAY DISINFECTANT - 150 ml - box of 12**  
 Ready to use disinfectant spray suitable for quick and effective disinfection of the surfaces and equipment in the workplaces. Keyboards, phones, desks, calculators and more. Acts in 15 minutes. It does not stain, does not wet, does not damage tissues and materials and releases a pleasant scent. Active on the Coronavirus family. Tested by an accredited EU laboratory. Bactericidal activity: EN 1040; EN1276; EN 13697; EN 13727; NF T 72-281 Fungicidal activity: EN 1275; EN 1650; EN 13697 Virucidal activity (Enveloped viruses, HIV, HB V, HCV, Coronavirus): EN14476

**FOR COMPUTER, KEYBOARDS, MOUSE ...**



## DISINFECTANT WIPES FOR SURFACES

• **36600 TEKNA DISINFECTANT WIPES FOR SURFACES - box of 600 (12 flowpacks of 50)**  
 Ready to use wipes designed to cleanse and disinfect simultaneously objects and surfaces, eliminating germs and bacteria. The presence in the formulation of Chlorhexidine, Benzalkonium and Alcohol (20% V/V) guarantees the deep disinfection of all washable surfaces, with an excellent detergent and degreasing action. Do not contain parfum, colorants and whitening agents. In accordance with EN1650, EN1276, EN13697.

**WIPES FOR OBJECTS AND SURFACES**



**CHEMICAL COMPOSITION**  
 100,00 g of the product contains: Benzalkonium chloride 0,10 g; Orthophenylphenol 0,02 g; Isopropyl alcohol; parfum; propellant q.s. to 100,00 g.  
 Italian MOH Registration No. 7604

**CHEMICAL COMPOSITION**  
 100.0 g of imbibed solution of alcoholic disinfectant contains: Chlorhexidine Digluconate 0.1 g; Benzalkonium chloride 0.1 g; Isopropyl alcohol; Ethyl alcohol; cofomulants; deperated water q.s. to 100.0 g. Italian MOH Registration No. 19354

## MULTILAYER DECONTAMINATING MAT WITH ANTIBACTERIAL



### DECONTAMINATING MATS

Mats to be used in all environments that require total absence of contaminating agents and the preservation of high hygienic levels. GIMA mat, thanks to antibacterial glue captures

and retains dust and bacteria and substantially reduces bacteria growth and spreading.

A full length adhesive sheet on the bottom of the mat provides a firm grip to the floor. Easy removability without leaving any adhesive trace. Each mat includes 30 numbered polythene sheets and a non-adhesive edge strip to allow easy removal of each used layer. Medical disposable device CE Class I non-sterile. Packed in a stylish dispenser folder with handle for easy carriage and vertical storage. Each mat can be easily picked leaving the others perfectly stored. Total mat thickness: 1.5 mm. Box of 5 mats with 30 sheets each. On request (minimum 10 boxes) available in white or green and size 60x95 cm or 90x95 cm. Multilingual instructions: GB, FR, IT, ES, PT, FI.

- 36685 DECONTAMINATING MAT 45x90 - box of 5 - blue
- 36686 DECONTAMINATING MAT 60x90 - box of 5 - blue
- 36696 DECONTAMINATING MAT 45x115 - box of 5 - white
- 36693 DECONTAMINATING MAT 45x115 - box of 5 - blue
- 36694 DECONTAMINATING MAT 60x115 - box of 5 - blue
- 36695 DECONTAMINATING MAT 90x115 - box of 5 - blue

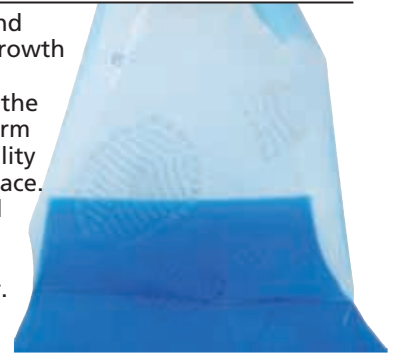

## ORMA AUTOMATIC SHOE ISOLATION COVERING SYSTEM

### • 36500 ORMA SHOE ISOLATION DEVICE

Easy to use automatic shoe isolation covering suitable for all types and sizes of footwear. It helps to reduce microbial spread in surgical and operating environments. The device applies a made-to-measure thermo reactive film, which completely wraps around the shoe, ensuring an isolating protective barrier. ORMA is controlled by a microprocessor chip, with programmable controls and commands (power: maximum 1.300W, standby 75W). An optional support is available to help keep balance during application.

Voltage frequency: 220 ±5% V - 50 Hz.

Multilingual manual: GB, FR, IT.

### • 36501 SUPPORT HANDLE - optional

### • 36502 SURGICAL SHOE COVER ROLL - box of 4

Each roll creates 1,000 shoe covers.



Orma automatically creates the shoe cover. When shoe is placed in the chamber, the heating system is activated and creates a cover, following shoe contours. This generates a completely isolating shoe protective barrier. Covers are waterproof and don't impede movement.



36501  
Support handle

**LIMIT CONTAMINATION IN YOUR PRACTICE**

Size: 80x44.5x33 cm  
Weight: 21 kg



## 99% ANTI-VIRUS AND ANTI-BACTERIAL SILVER FILMS

- 36505 ANTIMICROBIAL ADHESIVE FILM 105 mic - roll 5 m
- 36506 ANTIMICROBIAL NON-ADHESIVE FILM 105 mic - roll 5 m
- 36507 ANTIMICROBIAL ADHESIVE FILM 200 mic - roll 5 m

Silver film developed to reduce indirect transmissions of virus and bacteria, available in three versions: clear adhesive and non-adhesive, silver coloured adhesive.

It reduces the viral load of 99,24% within 30 minutes, 99,76% within 1 hour and 99,97% within 24 hours, after coming into contact with virus and bacteria.

Each type can be applied on a wide range of objects and surfaces in different environments: public and medical facilities, home, shops, devices.

Unique 105 mic or 200 mic thickness ensures more efficacy compared to similar products, the 105 mic or 200 mic thickness and silver presence provide better protection.

Silver-ion prevents bacteria and virus proliferation: silver nanoparticles penetrate inside the virus destroying bacteria through a response called "IONIC reaction"

High transparency and anti-glare

Anti-fingerprints and anti-shatter: special coating eases

removal of fingerprints or stains and protects from damages.

Entirely made of PET which maintains clear and clean status.

3H level of Hardness assures durability (>6 months) and protection from external shocks and scratches.

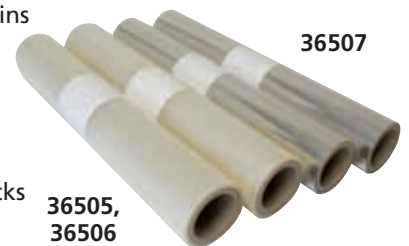

SILVER FILMS - roll 5 m x 400 mm			
Types	Adhesive	Non-adhesive	Adhesive
Thickness	105 micron	105 micron	200 micron
Colour	Clear	Clear	Silver
	(Anti-Glare)	(Anti-Glare)	
Durability	> 6 months	> 6 months	> 6 months
Applications	Touchscreens, IT devices, displays, .....	Button areas (elevator, copier, printer, ....)	General use (flat and non-flat surfaces)
Medical Device Directive 93/42/ECC			
Antiviral test: ISO21702		Antibacterial test JIS Z-2801	



# BRANSON ULTRASONIC CLEANERS

## Precision cleaning power

Ultrasonic cleaning is faster and safer than any other method. The deep-cleaning action removes heavy oils and waxes, even the most stubborn dirt and contaminations. It penetrates to deflux circuit boards and cleans tiny precision assemblies. Ultrasonic sound waves, moving through a cleaning solution, create an effect called cavitation, the rapid formation and implosion of microscopic bubbles. Heat enhances the process.

### Branson: pioneer in ultrasonic cleaning

- easy to handle and safe to fill
- frequency higher than average for a deep cleaning
- less noise - longer lifetime.

All Branson cleaners are supplied with tank cover and multilingual manual (GB, FR, IT, ES, DE, PT, SE, NL, RU). Recommended use with optional wire mesh basket.

### M Series: M (Mechanical timer) or MH (Mechanical timer with heater)

Includes 60-minute mechanical timer and continuous operation with heating capability (MH only).

### CPXH Series (Digital control with heater)

The most technologically advanced ultrasonic cleaners available. With programmable features, digital operation with power tracking capabilities to adjust for light or heavy loads, high/low power control and degassing.

CPX series is completely programmable, so engineers can choose temperature, start, and stop times for "set-it-and-forget-it" operation

Temperature can be set for either Fahrenheit or Celsius up to 69 °C/156.2 °F

Degassing periods of up to 99 minutes also allow for various sample prep applications.

Digital timer allows for continuous ultrasonic operation up to 99 minutes. Ultrasonic power tracking maintains steady, consistent activity in the both when condition change



Features	M Series Mechanical	MH Series Mechanical	CPXH Series Digital
Timer	60 minutes	60 minutes	60 minutes
Cover	•	•	•
Continuous mode	•	•	•
Sweep frequency	•	•	•
Heater	•	•	•
Dual power	•	•	•
Power tracking	•	•	•
Degas wave modulation	•	•	•
°C or °F temp selection	•	•	•
Auto ultrasonic activation	•	•	•
High-temp alarm	•	•	•
Front panel auto temp calibration	•	•	•
Operating parameters stored and saved	•	•	•

High/low power control provides safer cleaning of delicate components. 100% power for normal or 70% for delicate applications

## BRANSON

3 MODELS: 4 SIZES EACH



ULTRASONIC CLEANERS	BRANSON 2800 2.8 litres	BRANSON 3800 5.7 litres	BRANSON 5800 9.5 litres	BRANSON 8800 20.8 litres
M Mechanical timer	35501	35511	35520	35531
MH Mechanical timer with heater	35502	35511	35521	35532
CPXH Digital timer with heater	35503	35512	35522	35533
ACCESSORIES	Branson 2800	Branson 3800	Branson 5800	Branson 8800
Tank cover, plastic* or stainless steel**	35507*	35517*	35527*	35537**
Wire mesh basket	35508	35518	35528	35538
Solid tray basket	35505	35515	35525	35535
Beaker positioning cover	35506 2x 250 ml	35516 3x 250 ml	-	-
Beaker positioning cover 600 ml	35509 2x 600ml	35519 2x 600ml	35529 4x 600ml	35539 6x 600ml
Glass beaker 250 ml	35540	35540	-	-
Glass beaker 600 ml	35541	35541	35541	35541



## GENERAL PURPOSE CLEANER

• 35544 BRANSON GENERAL PURPOSE CLEANER - bottle 1 l concentrate  
A cleaning solution developed for use with ultrasonic cleaners. Removes general soils, fingerprints, dust, light oils and greases. It has been specially developed to provide optimal transfer of acoustic energy. Mainly used in: dentistry, medical and optical applications, laboratory, electronics.

CHEMICAL SPECIFICATIONS	
Concentration: 10-12%	Concentration PH: 13.5
Biodegradability: yes	Rinsability: good
Phosphate free	

## S/S BEDPAN WASHER

### • 35560 POSEIDONE BEDPAN WASHER

Designed to be used as a sink for organic substances and for washing and cleansing medical and sanitary devices such as: stainless steel or plastic urinals and bedpans, suction bottles, urine container.

Two washing programs: FAST cycle for urinals (max 130 seconds), NORMAL cycle for bed pans (max 300 seconds). Front panel displays running status and the active alarm.

- electronic digital control
- light and acoustic warning
- function reset for changing the cycle
- function play/pause for the selected cycle
- instant stop of the cycle, in case of door opening
- made of stainless steel
- electronic check of electric pump

Multilingual manual: GB, FR, IT, Medical Device Class I

#### TECHNICAL SPECIFICATIONS

Automatic stand-by:	at the end of the cycle
Maximum absorption:	2.8W in stand-by mode
Power supply - consumption:	230VAC - 50/60Hz - 400 W
Size:	536x735xh 930 mm



35560

MADE IN ITALY

## WATER DISTILLER

It produces pure and clean water through a natural and effective process. Water is brought gradually to 100 °C

It eliminates:

- virus, bacteria, organic and inorganic chemical substances
  - heavy metals and contaminated agents settle in the bottom.
  - impurities smells in the cooling coil.
- Water is further purified by the active coal filters present in the filter holder collector.

Multilingual manual: GB, FR, IT, ES, DE



35690

### • 35690 WATER DISTILLER

The autoclaves must run with distilled or demineralised water to avoid problems on electrovalves and on internal mechanism and white traces of limestone on the sterilized tools and devices.

Distiller produces 100% distilled water in a cheap and safe way. It produces 4 litres in about 7 hours.

It is equipped with an automatic control thermostat with block system at the end of operation.

Supplied with 6 active coal filters, 1 detergent, 1 container for produced distilled water. Operating Voltage: 220 V - 50-60 Hz. Size Ø 20 cm x h 36 cm. Weight: 3.4 kg

### • 35692 DETERGENT FOR DISTILLER

## GERMY GIMA PLUS: ULTRAVIOLET LAMPS WITH TIMER

AVAILABLE IN 3 SIZES

- 35740 GERGY GIMA PLUS 8 W WITH TIMER - 38x20xh17 cm
- 35741 GERGY GIMA PLUS 15 W WITH TIMER - 50x24xh20 cm
- 35742 GERGY GIMA PLUS 30 W WITH TIMER - 96x24xh20 cm

These instruments incorporate a germicidal ultra-violet lamp which rapidly destroys every micro-organism hit by its rays. Recommended to keep the instruments stored inside sterile. Instruments previously sterilized can be preserved for a long time and they are always ready for use (UV treatments do not generate heat).

An inside supporting grate keeps instruments raised from reflecting surface which enables both surfaces to be uniformly irradiated, improving the UV germicidal action.

Operator safety is guaranteed by a micro switch which extinguishes the lamp if door is opened.

Solid construction, painted steel outside and reflecting stainless steel inside. Manual in GB, IT.

Installation on table or wall.

Operating voltage: 230 V - 50/60 Hz - 1 A.

- 35754 SPARE NEON LAMP - 8 Watt
- 35755 SPARE NEON LAMP - 15 Watt
- 35756 SPARE NEON LAMP - 30 Watt



35741

MADE IN ITALY

## GIMA QUICK: STERILIZATION IN 2 MINUTES

### • 35640 GIMA QUICK - hot bead sterilizer

### • 35642 GIMA QUICK PLUS with thermometer

Designed for all day continuous use in medical, dentistry, podology, veterinary, tattoo and beauty studios.

It ensures a quick and effective sterilization.

It sterilizes files, mirrors and surgical instruments in 2 minutes, curettes and forceps in 3 minutes.

Its constant temperature over 230°C ensures the total destruction of micro-organisms and spores in few seconds.

GIMA QUICK has epoxydic powders painted steel casing; the inside cylinder is completely isolated by fibres and glass, which prevents heat from being transmitted to the external casing.

Supplied with a pack of glass beads (225 g), manual in GB, IT.

### • 35646 PACK OF GLASS BEADS - 225 g

#### TECHNICAL SPECIFICATIONS

Outer structure in white painted steel	Weight:	2.8 kg
Copper plated basket: Ø 5.5 cm	Power consumption:	150 W
depth 7.5 cm	Operating voltage:	220 V - 50 Hz
Size:		130x150x200 mm

CONTINUOUS USE



CE 0425

35640

35642

MADE IN ITALY

# STANDARD, VENTILATED, DIGITAL DRY HEAT STERILIZERS



35580

Outer case and front completely made of stainless steel, included the drummed door strongly insulated with non-conducting material



35586

Outer case made of steel, hinged door completely made of stainless steel



MADE IN ITALY



35583

## TITANOX DRY HEAT STERILIZERS 20, 60, 120 LITRES.

Inner structure and height adjustable inner shelves completely made of stainless steel. Door with lock and key.

**Standard unit:** Double resistance for reaching high temperatures faster.

**Thermovenilated unit:** to guarantee the uniformity of the temperature in the heating room and to allow the circulation of the air. The device is provided with a ventilation motor that is always in operation, both during the cycle of heating and during the pauses of cooling.

- safety thermostat
- ventilator for forced ventilation
- double check up light bulb

**Digital unit:** adjustable aeration tunnels, placed on the bottom of the right side and on the top of the left side for hot air

Standard	Thermovenilated	Digital	Capacity	Outside dimensions (mm)	Inside dimensions (mm)
35580	35583	35586	20 l	570x345xh 400	405x255xh 210
35581	35584	35587	60 l	705x450xh 475	535x320xh 345
-	35585	35588	120 l	835x565xh 555	670x420xh 415



35587

adjustment and circulation, which is useful for a quick cooling of the device.

- electronic running C.P.S.
- optimum heat distribution
- automatic indication for possible problems of feeding (in case of mains tension lack, the program will start again from the beginning)
- safety thermostat

All models supplied with manual in: GB, FR, IT, (ES on request) and 2 height adjustable trays.

### TECHNICAL SPECIFICATIONS

Standard and thermovenilated:	
Timer:	0-120 minutes that switches off the oven at the end of the planned time
Probe thermometer:	from 0° to 200°
Probe thermoregulator:	from 0° to 200°
Operating voltage:	230 V - 50/60 Hz
Digital:	
Operating mode:	continuous (stand by) or timed
Timer:	from 0 to 250 minutes
Operating voltage:	230 V - 50/60 Hz

## DRY HEAT STERILIZERS 3 OR 5 LITRES

- 35575 TITANOX DRY STERILIZER - 3 l
- 35576 TITANOX DRY STERILIZER - 5 l

Outer case made of stainless steel. Inner structure, grid, removable perforated tray and hinged lid completely made of stainless steel. Inner structure and lid with non-toxic silicon rubber gasket, insulated by high grade glass wool. Stainless steel armored heating element. Timer from 0 to 120 minutes, which disconnects the device at

### TECHNICAL SPECIFICATIONS

	35575	35576
Capacity:	3 l	5 l
Timer:	from 0 to 120 minutes	
Probe thermometer:	from 0° to 200°C	
Probe thermo-regulator:	from 0° to 200°C	
Operating voltage:	230 V-50/60 Hz	
Overall dimensions:	400x295xh 170 mm	500x325xh 170 mm
Inside dimensions:	300x125xh 80 mm	400x160xh 80 mm
Classification:	Class IIB, EU 2017/745 Medical Device	

the end of the programmed time. Safety thermostat. Green pilot light (on the right) shows the line insertion. Green pilot light (on the left) points out the resistance operation. Supplied with manual in GB, FR, IT (ES on request).



MADE IN ITALY



# HOT AIR STERILIZERS: GIMETTE 1.5, 7, 21, 28 AND 50 LITRES

MADE IN ITALY



GIMETTE 1,5

35601



GIMETTE 7

35607

- 35601 GIMETTE 1.5 - hot air sterilizer
  - 35607 GIMETTE 7 - hot air sterilizer
- Automatic Gimette are compact and high quality hot air sterilizers with the same reliability and efficiency as larger models. Outside structure is made of painted plate with anti-scratch epoxy powder. Stainless steel lid and sterilization chamber with approx. capacity of 1.5 l and 7 l. Removable, perforated for air circulation, tray with pliers. All components certified by most important European brands, assembling in compliance with EN-61010. A second safety thermostat triggers in case temperature should exceed 220°C. Red LED indicates any anomaly in thermoregulation and consequent starting of safety thermostat.
- 35631 RESISTOR 250 W for 35601 - spare
  - 35632 RESISTOR 400 W for 35607 - spare
  - 35612 GASKET for 35607 - spare
  - 35613 GASKET for 35601 - spare

### TECHNICAL SPECIFICATIONS

<b>GIMETTE 1.5</b>	
Inside dimensions:	245x120x50 mm = vol. 1.5 dm <sup>3</sup>
Outside dimensions:	310x180x180 mm
Power consumption:	250 Watt
<b>GIMETTE 7</b>	
Inside dimensions:	410x180x90 mm = vol. 7 dm <sup>3</sup>
Outside dimensions:	490x310x180 mm
Power consumption:	400 Watt
Thermometer:	high precision with capillary bulb
<b>Same specifications for both models:</b>	
Operating Voltage:	230 V - 50/60 Hz
Thermostat:	automatic, adjustable 0-200 °C
Timer:	manual from 0 to 120 minutes
2° Thermostat:	bi-metallic certified
Green LED:	timer, orange LED: heating, red LED: alarm
User/Service manual in IT, GB, FR	

MADE IN ITALY



GIMETTE 21

35621



GIMETTE 28

35628

- 35621 GIMETTE 21 - hot air sterilizer
  - 35628 GIMETTE 28 - hot air sterilizer
  - 35629 GIMETTE 50 - hot air sterilizer
- Fully automatic hot air sterilizer, with adjustable temperature from 0°C to 200°C, kills off even particularly resistant micro-organisms. Stainless steel structure is powder painted, except for the door, to assure maximum heat and shock resistance over time. Four perforated, anodized aluminium trays make hot air circulation easier. Capacity approximately 20 l, 28 l and 50 l. A second safety thermostat triggers in case temperature should exceed 230°C.



Red LED indicates any anomaly in thermoregulation and consequent starting of safety thermostat.

### TECHNICAL SPECIFICATIONS

	GIMETTE 21	GIMETTE 28	GIMETTE 50
Inside dimensions mm:	300x250x260	380x250x260	405x340x350
Approx. volume	20 dm <sup>3</sup>	28 dm <sup>3</sup>	50 dm <sup>3</sup>
Outside dimensions mm:	440x340x400	550x340x400	605x460x480
Weight:	13 kg	17 kg	24.5 kg
Power consumption:	600 Watt	500 Watt	1200 Watt
<b>Same specifications for 3 models:</b>			
Operating Voltage:	230 V - 50/60 Hz		
Fuses:	2 x 4 A (35621, 35628) 2 x 8 A (35629)		
Timer:	manual from 0 to 120 minutes		
Thermostat:	automatic		
Thermometer:	high precision with capillary bulb		
2° Thermostat:	bi-metallic certified		
Green LED:	timer, orange LED: heating, red LED: alarm		
User/Service manual in IT, GB, FR			

### SPARE ACCESSORIES

STERILIZER	TRAY	GASKET	RESISTOR 600 W
Gimette 21	35610	35614	35639
Gimette 28	35611	35615	35639
Gimette 50*	-	35617	35639

\*Needs 2 resistors

# HYDRA EVO ELECTRONIC AUTOCLAVE 15 L - N - WITH PRINTER

• **35660 HYDRA EVO AUTOCLAVE with printer - 15 l - 230 V**  
Automatic steam autoclave for the sterilization of unwrapped instruments. Closure system with an operator safety pivot. Thermodynamic system for the ejecting of the "cool" air locks.

**Two sterilization cycles: 121°C and 134°C**  
Automatic phases of pre-heating, sterilization cycle and drying.  
**Pre-set, non-modifiable cycles**  
All cycles are pre-set at the factory and guarantee perfect and safe sterilization of treated materials.

There is no way the operator can manipulate or alter the cycles, to avoid risks caused by human error.

**Pre-set temperatures 134°C and 121°C**

The 134°C cycles are normally used for the sterilization of solid and ferrous materials. 121°C cycles are normally used for sterilization of thermoplastic and delicate materials.

**Water tanks**

HYDRA EVO is equipped with an internal tank for pure water and another for used water. Each tank is equipped with probes to detect the minimum and maximum water levels.

**Fully automatic cycles**

All cycles are fully automatic, with all steps managed by the leading-edge computer board with a powerful microprocessor. Each step (vacuum, preheating, exposure time, drying) is automatically monitored, assisted and handled. There is no need for human intervention in cycle management.

**Safety on the door with 2 locks**

- a mechanical one which does not open when pressure is exerted
- a dynamic one, operating with a special form of door seal.

**Built in printer**

Built in printer for the registration of carried out cycles.

**Safety devices installed**

- Certified safety valve - PED on sterilization chambers
- chamber insulation with certified ceramic material.



MADE IN ITALY  
93/42/EEC Medical device  
73/23/EEC Low tension  
93/36/EEC Electromagnetic Compatibility



35660



**Controls on the Autoclave**

- control of the water fed into the chamber
- Safety Thermostat and time control

The sterilization chamber is completely stainless steel AISI 304, heated by a band shaped heating element which grants uniform heat propagation. Supplied with four aluminium trays, key for their extraction, user manual (GB, IT).

- 33250 THERMAL PAPER 57 mm x 25 m - pack of 5 rolls
- 35671 SEALING GASKET - spare for 35658, 35659, 35660
- 35669\* HEATING BAND DHY A035 for 35650, 35654
- 35670\* HEATING BAND DXB A835 for 35658, 35659, 35660

\*Need serial number of autoclave

**TECHNICAL SPECIFICATIONS**

Stainless steel chamber: Ø 24.5x32 cm  
External size: 51x39x59 cm (WxHxD)  
Net weight: 54 kg  
2 sterilization cycles: 121°C and 134°C  
Operating Voltage: 230 V ±10% - 50/60 Hz  
Power consumption: 1500 W  
Class N  
Noise level: <70 dBA  
Altitude operating range: 0-2000 m



CYCLES	MATERIALS	STERILIZATION TIME	MAX LOAD	WORKING PRESSURE
Not wrapped 121° C	<ul style="list-style-type: none"> <li>• Fragile solids</li> <li>• Rubber solids</li> <li>• Glass</li> <li>• Turbines if indicated by producer</li> </ul>	35 min.	4kg 1 kg load in any tray	1.2÷1.3 bars
Not wrapped 134° C	<ul style="list-style-type: none"> <li>• Stainless metal solids</li> <li>• Turbines if indicated by producer</li> </ul>	21 min.	4kg 1 kg load in any tray	2.1÷2.2 bars

# PRESTIGE CLINICAL AUTOCLAVES: EXCELLENCE THROUGH DESIGN



**PRESTIGE AUTOCLAVES - class N**

Prestige is one of the world's largest selling and most cost effective automatic autoclave available, with an enviable reputation for reliability, durability, safety and quality.

- method recommended by healthcare professional worldwide including the World Health Organisation (WHO)
  - each autoclave is computer tested and issued with a unique Performance Test Certificate
  - at only 4.5 kg net weight, it offers full device portability
- Recommended for infection control not only in hospital and general medical and dental surgeries, but also in veterinary, chiropody, professional beauty, tattooists, acupuncture, laboratories and schools.

Comply with: IEC 61010 (product safety), BS3970 part 4 (pressure vessel only), BS 5500 (pressure vessel).

Supplied with basket and multilingual manual: GB, FR, IT, DE, ES, PT, NL, DK, NO, SE, GR.

**TECHNICAL SPECIFICATIONS**

	35709	35712
Capacity:	9 l	12 l
Chamber internal dimensions (D/H)	210/236	210/328
Maximum instrument length (diagonal):	228 mm	290 mm
Maximum loading weight:	3 kg	4 kg
Width/height:	340/335	340/420

**Same specifications for 2 models:**

Sterilizing time: 11 minutes  
Cycle time (nominal): 22 minutes  
Operating pressure: 1.40 bar  
Sterilizing temperature: 126 °C  
Operating voltage: 230 V - 50-60 Hz - Power 1,250 Watt



GIMA code	PRESTIGE MEDICAL AUTOCLAVES
35709	Prestige autoclave 9 litres
35712	Prestige autoclave 12 litres
35720	Silicone sealing gasket
35724	Depressurization valve - since 2011

# EUROPA B EVO: CLASS B AUTOCLAVE 15 AND 24 l

Tray holder with 4 aluminium trays



Supplied with 1 closed tray holder, 4 aluminium trays, 1 double-use key for tray extraction and door adjustment, water loading and unloading hoses, chamber cleaning sponge and integrated osmosis system (35657 only)

Multilingual manual: GB, FR\*, IT, ES\*, PT\*, DE\*  
\*Downloadable from [www.gimaitaly.com](http://www.gimaitaly.com)



35653

MADE IN ITALY



Constant control and monitoring of the entire autoclave functional system.



Sterilization Cycles  
121°C-134°C suitable for both enveloped and free materials.  
All cycles are for type-B loads.

As regards to safety in health practice, sterilization is the first aspect to consider. Autoclaves offer physical and legal safety. This is why autoclaves must be chosen according to rational logics and based on professional and not only cost-related evaluations.

The EN 13060 standard guides professional to select adequate, certified autoclave based on the type of materials to sterilize. A B-type loads autoclave allows to sterilize hollow materials such as handpieces and turbines and porous materials (overalls, gauze...).

### P.I.D. System (Proportional Integral Derivate)

It represents the top of closed loop controls. P.I.D. and ensures a constant control and monitoring of the whole operating system of the autoclave, acting automatically in case of anomalies or incorrect technical and electronic parameters.

### Internal tanks

All the autoclaves are equipped with an internal tank for pure water and another for used water. Each tank is equipped with probes to detect the minimum and maximum water levels.

### Preset temperatures

The preset temperatures used in our autoclaves cycles are 134°C for sterilization of solid and ferrous materials and 121°C for sterilization of thermoplastic and delicate materials.

### Ease of use

First button allows to scroll and view data about all sterilization cycles on the display and select the cycle, second button automatically starts the whole sterilization cycle. This makes it possible to choose cycles which best suit materials. In case of any error or warning a series of messages and LEDs will inform you about the problem.

### Fully automatic cycles

All cycles are fully automatic, all steps managed by the leading-edge computer board with a powerful microprocessor. Each step (vacuum, preheating, exposure time, drying) is automatically monitored, assisted and handled. There is no need for human intervention in cycle management.

**Cycles without operator intervention and with auto-shutdown**  
In sterilization cycles an automatic function will trigger an anti-condensation process and auto-shutdown if the operator is not by the machine when the cycle ends.

35657



Integrated osmosis system

Autoclave equipped with integrated printer

### Test cycles

Our autoclaves are equipped with test cycles for periodic control by means of physical and functional tests. Helix test, to assess vacuum capacity in hollow bodies. Bowie & Dick test to evaluate vacuum capability in hollow bodies. Vacuum test to evaluate vacuum retaining capability.

### Constantly monitored cycles

A device constantly controls and monitors the sterilization cycles. Any anomaly or uncommon feature is quickly detected and immediately blocked if it jeopardises the sterilization cycles. The operator is warned of the anomaly by a message.

### All cycles ensure sterilization of B-type loads

All the sterilization cycles feature the fractional vacuum system as well as the controls of parameters that ensure sterilization of B-type loads. Therefore, even if the type of cycle chosen is incorrect the sterilization carried out on the material will be equally adequate.

### Integrated Osmosis system (35657 only)

Inverse osmosis is a safe water treatment system that eliminates even the tiniest polluting particle, to guarantee bacteriological purity. It works through an osmotic membrane which is able to filter water down the molecular levels.

GIMA code	CLASS B AUTOCLAVES
35653	Europa B Evo Autoclave - 15 l
35657	Europa B Evo Autoclave - 24 l with integrated osmosis system
SPARES for EUROPA B and ANDROMEDA	
35671	Sealing gasket
35672	Bacterial filter for Europa B conical threading 1/8 Compatible also with W&H, Cominox, Mocom, Mediline, Euronda
35673	Vapor Line sterilization integrator
33250	Thermal paper 57mm x 25m (pack of 5 rolls)

Cycles	Working pressure min-max	Minimum time of the total cycle* - minutes	
		Europa B EVO	Europa B EVO 24
121° C Wrapped	1.04 - 1.30	60 min. (25+18+17)	56 min. (25+18+13)
121° C Unwrapped	1.04 - 1.30	49 min. (25+18+6)	55 min. (25+18+12)
134° C Flash	2.02 - 2.38	31 min. (25+4+2)	33 min. (25+4+4)
134° C Wrapped	2.02 - 2.38	47 min. (25+5+17)	43 min. (25+5+13)
134° C Unwrapped	2.02 - 2.38	36 min. (25+5+6)	42 min. (25+5+12)
134° C Prion	2.02 - 2.38	62 min. (25+20+17)	58 min. (25+20+13)

\*The total time includes: vacuum, pre-heating time, cycle and drying phase.

The times are to be intended for a fully loaded autoclave.

All sterilization cycles have 3 stages of vacuum.

Vacuum and pre-heating time can vary depending on the conditions of autoclave from 25 to 35 minutes

	TECHNICAL SPECIFICATIONS	
	35653	35657
	<b>Europa B - 15 l</b>	<b>Europa B - 24 l</b>
External size mm (WxHxD):	510x390x590	510x390x730
Chamber size mm (Øxdept):	245x318	245x500
Operating voltage	230 V - 50/60 Hz	230 V - 50/60 Hz
Max absorbed power	1,700 W	2,200 W
Weight kg:	54	58
Built in printer:	yes	yes
Manual closing:	yes	yes
Fitting for pura deioniser:	yes	yes
PID system	yes	yes

## ROUND STERILIZER DRUMS - STAINLESS STEEL AISI 304



GIMA code	STERILIZER DRUMS	GIMA code	STERILIZER DRUMS
26675	Ø 150x h 100 mm	26683	Ø 290x h 160 mm
26674	Ø 150x h 150 mm	26684	Ø 290x h 240 mm
26676	Ø 165x h 120 mm	26687	Ø 290x h 290 mm
26678	Ø 180x h 180 mm	26689	Ø 340x h 180 mm
26680	Ø 190x h 160 mm	26688	Ø 340x h 240 mm
26677	Ø 190x h 240 mm	26685	Ø 340x h 340 mm
26681	Ø 240x h 160 mm	26686	Ø 390x h 250 mm
26679	Ø 240x h 190 mm		

**ROUND STERILIZER DRUMS** for autoclave and hot air sterilizer. Cylindrical containers used to sterilize dressing materials (gauze compress or cotton etc.) in a steam sterilizer (autoclave) or hot air sterilizer and to keep them as "sterile". Drums have an effective closing lid with a clip lock system, a carrying handle, air vents system to allow steam to circulate freely during the sterilization cycle/process. Easy to operate lateral air vent system to be manually closed after sterilization.

## STAINLESS STEEL BOXES WITH OR WITHOUT HANDLE



**STAINLESS STEEL BOXES - Autoclavable 125°C**

- 26653 STAINLESS STEEL BOX 18x8xh 4 cm
- 26654 STAINLESS STEEL BOX 20x10xh 6 cm
- 26655 STAINLESS STEEL BOX 25x12xh 6 cm
- 26656 STAINLESS STEEL BOX 30x15xh 6 cm
- 26657 STAINLESS STEEL BOX 50x20xh 10 cm
- 26672 SILICONE TRAY 20x10 cm for 26654



**STAINLESS STEEL BOXES WITH HANDLES - Autoclavable 125°C**

- 26668 STAINLESS STEEL BOX 18x8xh 4 cm
- 26669 STAINLESS STEEL BOX 20x10xh 4.5 cm
- 26670 STAINLESS STEEL BOX 25x12.5xh 4.5 cm
- 26671 STAINLESS STEEL BOX 30x15xh 6 cm
- 26667 STAINLESS STEEL BOX 50x20xh 10 cm
- 26672 SILICONE TRAY 20x10 cm for 26669

## ALUMINIUM BOXES

Useful containers for the sterilization of surgical instruments and to maintain them sterile. Silicone tray not included. Nice aluminium box with blue base and silver cover.

- 26662 ALUMINIUM BOX 17.5x7.6xh 2 cm
- 26663 ALUMINIUM BOX 18.5x9.5xh 3 cm
- 26664 ALUMINIUM BOX 21.8x10.6xh 3 cm
- 26665 ALUMINIUM BOX 21.8x10.6xh 5 cm
- 26672 SILICONE TRAY 20x10 cm (for 26669, 26664, 26665)



# ALUMINIUM STERILIZATION CONTAINER SYSTEM



STANDARD CONTAINER WITH FILTER* Not for sale in Germany			
LID COLOUR	NON PERFORATED BOTTOM		PERFORATED BOTTOM
Height mm	SMALL 285x280 mm		
	1 filter		2 filter
100	37000	37010	37030
135	37001	-	37031
150	37002	37012	37032
200w	37003	-	37033
260	37004	-	-
MEDIUM 465x280 mm			
1 filter		2 filter	
100	37050	37060	37080
135	37051	-	37081
150	37052	37062	37082
200	37053	-	37083
LARGE 580x280 mm			
2 filter		4 filter	
100	37100	37110	37130
135	37101	-	37131
150	37102	37112	37132
200	37103	-	37133
260	37104	-	-

\*Perforated bottom allows much quicker sterilization process (half time than with not perforated). Lock nail on bottom side made of chrome

BARRIER SYSTEM CONTAINER WITH VALVE** Not for sale in Germany			
LID COLOUR	NON PERFORATED BOTTOM		PERFORATED BOTTOM
Height mm	SMALL 285x280 mm		
	1 filter		2 filter
100	37150	37160	37180
135	37151	-	37181
150	37152	37162	37182
200	37153	-	37183
260	37154	-	-
MEDIUM 465x280 mm			
1 filter		2 filter	
100	37200	37210	37240
135	37201	-	37241
150	37202	37212	37242
200	37203	-	37243
LARGE 580x280 mm			
2 filter		4 filter	
100	37250	37260	37280
135	37251	-	37281
150	37252	37262	37282
200	37253	-	37283
260	37254	-	-

\*\*This system is preferred when is requested continuous use of containers, it avoids filter replacement. Valve opens during sterilization to allow exit of steam. Lock nail on bottom side made of chrome.

## STAINLESS STEEL WIRE BASKETS

WIRE BASKET - stainless steel			
Size mm	Height		
	50 mm*	70 mm**	100 mm***
255x245	37301	37302	37303
405x255	37306	37307	37308
540x255	37311	37312	37313

\*Suggested for container with height 100/135 mm  
 \*\*Suggested for container with height 135/150 mm  
 \*\*\*Suggested for container with height >150 mm



## ACCESSORIES FOR CONTAINERS

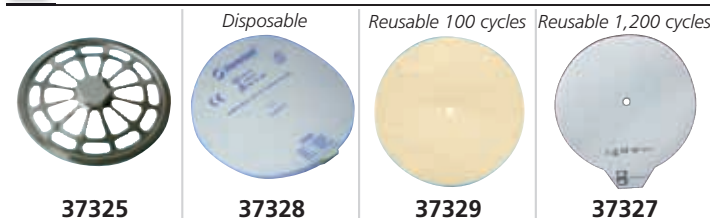

GIMA code	FILTERS FOR STANDARD CONTAINERS
37325	S/S Filter holder for paper/textile Ø 18 cm
37328	Disposable Paper filter Ø 18.6 cm with steam indicator - box of 100
37329	Reusable Textile filter* Ø 20.5 cm - standard container
37327	Reusable PTFE Teflon filter** Ø 19 cm

\*Long term filter can be used for 100 cycles  
 \*\*Extra long term filters can be used for up to 1,200 sterilization cycles.  
 Thickness 0.75 mm. Pore width approx. 2.5 µm

SECURITY SEALS see page 433

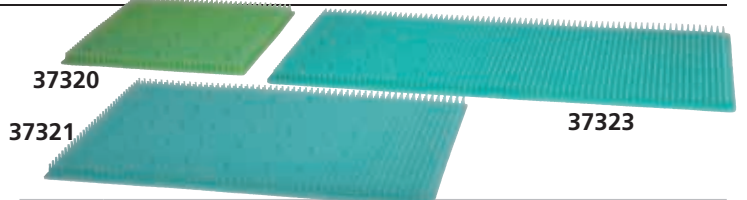

GIMA code	SILICONE MATS
37320	Silicone mat 220x230 mm - perforated - small
37321	Silicone mat 380x230 mm - perforated - medium
37323	Silicone mat 520x230 mm - perforated - large



GIMA code	CONTAINER CARDS
37333	Container card with steam indicator 68x37.5 mm - box of 250
37334	Self-adhesive container seal label with pin*** - box of 1100

\*\*\*To secure container and prevent opening by un-authorized staff

## TESTS FOR AUTOCLAVE

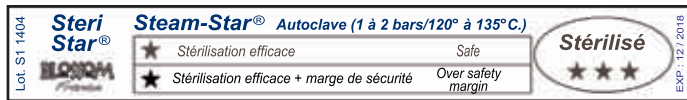

Notice "Stérilisé" and three stars drawing change colours  
 from white to dark brown to show safe sterilization of 121°C - 15 minutes or 134°C - 3.5 minutes  
 from white to black to show sterilization over safety margin 121°C - 20 minutes or 134°C - 5 minutes

EN 867 - Class D  
 ISO 11140 - Type 6

- 35849 "STEAM STAR" INDICATOR - autoclave - box of 1,000
- Indicator for sterilization by autoclave with pressure 1 to 2 bar 120°C/135°C. No special stocking requirements. Safety and reliability.

MADE IN JAPAN

## TYPE 5 STEAM INDICATOR

Conform to ISO 11140 - type 5

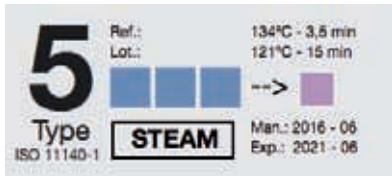

Package and manual in: GB, IT, FR, ES, PT, GR, DE

Non-toxic / lead free

- 35953 TYPE 5 STEAM INTEGRATOR - box of 500 pcs
- Integrators can be used in addition to the batch control Helix. It allows to re-affirm sterilization condition inside trays or containers.
- SV: 134 °C - 3.5 min / 121 °C - 15 min
- shelf life: 5 years after production
- packed in an easy dispensing carton
- clear colour transition from blue into pink of lacquer covered indicator

## TYPE 6 STEAM INDICATOR



- 35955 TYPE 6 EMULATING STEAM STRIPS - box of 250 strips
- Type 6 emulating steam indicator strips are designed to be used in steam sterilizers operating at 121 °C - 15 min and 134 °C - 3.5 min. The cycle verification indicators can be used in every pack and will provide assurance of steam penetration into the packs and presence of all critical parameters of steam sterilization cycle.
- The water based, non-toxic chemical indicator in compliance with ISO 11140-1 will show a clear and accurate colour change from blue to lilac after successful steam sterilization.

## TYPE 5 EO INDICATOR



- 35956 ETHYLENE OXIDE STRIPS - box of 250 dual strips
- Type 5 Ethylene Oxide (EO) indicator strips are designed to be used at E.O. sterilizers in compliance with ISO 11135. The indicator strips can be used in every pack and will provide assurance of E.O. gas penetration into the packs.
- The water based, non-toxic chemical indicator in compliance with ISO 11140-1 will show a clear colour change from white to yellow after successful sterilization.
- Test indicator strips are cost effective and can be divided into two separate pieces for economical use.

## SEALS WITH/WITHOUT STEAM INDICATOR

Container seals for steam sterilization processes. Conform to ISO 11140-Type 1.

GIMA code	PLASTIC SECURITY SEALS - 2.7 cm LONG PIN	Minimum order
37330	Security seal - blue	box of 100
37340	Security seal - red	box of 100
37341	Security seal - yellow	box of 100
37332	Security seal with steam indicator - blue	box of 100
37343	Security seal with steam indicator - red	box of 100
37344	Security seal with steam indicator - yellow	box of 100

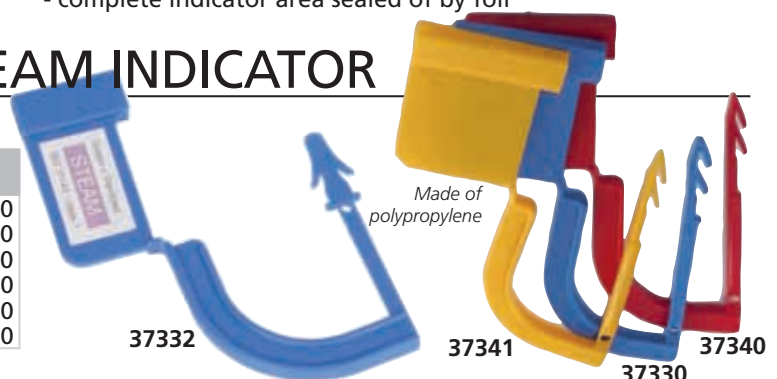

## 3M™ COMPLY™ STERIGAGE™



- 35959 3M™ COMPLY™ STERIGAGE™ CHEMICAL INTEGRATOR - box of 1,000
- 3M™ Comply™ (SteriGage™) Chemical Integrator 1243A is a Class 5 Integrating Integrator that meet the performance requirements of ANSI/AAMI/ISO 11140-1:2005.
- moving front ink technology provides easy to read "Accept or Reject" result
- can be used in all 250-275°F steam sterilization cycles
- response correlates results correlate with a Biological Indicator at three time/temperature relationships under ideal steam sterilization conditions

## TYPE 4 STEAM INDICATOR



- 35954 TYPE 4 MULTI-VARIABLE STEAM STRIPS - box of 250 dual strips
- Type 4 multi-variable steam indicator strips are designed to be used in steam sterilizers operating at 134 °C - 3.5 min. The indicator strips will provide assurance of steam penetration into the packs.
- The water based, non-toxic chemical indicator in compliance with ISO 11140-1 will show a clear colour change from blue to black after successful steam sterilization.
- Test indicator strips are cost effective and can be divided into two separate pieces for economical use.

## TYPE 5 MOVING FRONT

Conform to ISO 11140 - type 5



User manual: GB, IT, FR, ES,

Non-toxic / lead free

- 35952 TYPE 5 MOVING FRONT INTEGRATOR - box of 1,000 pcs
- Moving front integrators 134 °C - 3.5 min are giving you the best interpretation possible in case of any failure in your steam sterilization cycle. If temperature is not reached or holding time was too short the dark colour will not reach the accept area.
- shelf life: 5 years after production
- packed in white aluminium re.closable bags
- very easy interpretation of result
- complete indicator area sealed off by foil



35853

## BOWIE & DICK TEST READY FOR USE

Colour change from dark to green



Test sheet before sterilization

Test sheet after sterilization Failed test

Test sheet after sterilization Correct test

- **35853 UPSTAR - "BOWIE & DICK" - test - 14x14x0.8 cm**
- The Bowie & Dick ready to use test pack is designed to control the proper functioning of steam autoclave and to test its ability to sterilize porous devices (compresses, fields, gowns, woven or non-woven,...).
- High sensitivity: detects any default.
- Easy interpretation.
- Stability of color change.
- Waterproof aluminium packaging

EN 867 - Class B  
ISO 11140 - Type 2

## BOWIE DICK TEST PACK

Package and manual in: GB, IT, ES, FR, PT, GR, DE.



Dimensions: 123x123x16 mm

ISO 11140 - 4 Type 2  
- EN 867 - 4 class B

- **35950 BOWIE DICK TEST PACK - box of 20 pcs**
- Used for daily monitoring of pre-vacuum steam sterilizer. Based upon the Bowie Dick test result, the steam sterilizer is released for usage during the day. The Bowie Dick test detects failures like air leaks, insufficient vacuum, inadequate steam penetration.
- fulfill requirements of EN 285 and ISO 17665
- independently tested to show performance similar to original pack
- clear blue - violet colour change
- easy to interpret and document
- non-Toxic / lead free

## BOWIE DICK HELIX TEST



Includes: cotton bag, helix device (tube 1.5 m), 100 tests and user manual GB, FR, IT, ES.

ISO 11140 - 1 Type 2  
- EN 867 part 5 class B

- **35951 BOWIE DICK HELIX TEST PACK - box of 100 pcs**
- Helix devices and their indicators detect failures during each cycle much earlier than other chemical indicators / integrators. The EN 285:2009 are specifying the Helix test (Hollow A) to be used as Bowie Dick Test as well as Batch Monitoring when hospitals are sterilizing hollow loads. Next to that, this Bowie Dick Helix Test is an obligatory test for class B Bench Top Steam sterilizers.
- clear transition of color into pink
- easy to interpret and document
- non-Toxic / Lead Free
- PCD guaranteed for 500 Cycles (134°C - 3,5 min)

## STEAM AND DRY HEAT ADHESIVE TAPE INDICATORS

### STEAM AND DRY HEAT TAPE INDICATORS

Gima range of tapes is specially formulated for packing purposes as well as to show visibly that the pack has undergone a sterilization cycle. The backing of the different tapes is made of strong, semicreped, impregnated paper which gives excellent conformability during the application. Sterile tapes unwind easily and can be torn by hand without difficulty. Special adhesives formulated to withstand high temperature and humidity ensure excellent bond to paper, plastic, non-wovens, board, metal, glass and linen. Each tape is individually packed with due date. Steam tape initial colour: light green



- for sterilization at 121°C - 10 minutes: from light to dark green
- for sterilization at 134°C - 2 minutes: from light to medium / dark green

TAPE INDICATOR - 50 m	Width 19 mm	Width 25 mm	Minimum order
Dry Heat Tape - hot air sterilizer	35842	-	12 rolls
Steam Tape - autoclave	35846	35847	12 rolls



ISO 11140-1 : 2014  
APPLICABLE TO TYPE 1 E1

## 3M™ COMPLY™ LEAD-FREE STEAM INDICATOR TAPE

- **35962 3M™ COMPLY™ LEAD FREE INDICATOR TAPE 1322 - 18 mm x 55 m - box of 28 rolls**
- It consists of adhesive, backing and chemical indicator stripes. Aggressive and pressure-sensitive adhesive designed to adhere to a variety of wraps, including untreated woven and disposable non-woven, paper and plastic wraps in order to secure the pack during steam sterilization. Backing is a beige crepe paper that provides the stretch needed for pack expansion. Chemical indicator lines shows a visual color change from off-white/tan to dark-brown/black when exposed to sterilization.
- not made with Natural Rubber Latex
- trusted, high quality adhesive
- lead Free Ink means no hazardous waste issues
- stretchable backing that minimizes tape "pop-off" during sterilization
- can be written on or labeled with pre-printed labels



UNI EN  
ISO 11140-1:2015



## DIGITAL SEALING MACHINES WITH/WITHOUT DOT MATRIX PRINTER



35909, 35910  
MADE IN ITALY

- 35909 D-400 SEALING MACHINE without printer
  - 35910 D-500 SEALING MACHINE with dot matrix printer
- Continuous sealing machines for medical pouches according to DIN rules 58953-7:2010 with or without dot matrix printer. They allow a 12 mm multi-line seal and features stand-by function and automatic infeed through photocell. D-500 is equipped with **built-in printer** to print different data on the bag (sterilization/expiry dates) during the sealing process in order to provide constant control on the sterility of your instruments, especially when the paper layer of the

sterilization bag is less tight, after 30 days, and consequently losing instruments sterility. Built in epoxy coated stainless steel. D-400 and D-500 are sophisticated units controlled by a microprocessor and equipped with a device to adjust temperature (displayed by LCD) and printing parameters. **The sealing pressure is automatically adjusted according to the material thickness.** It also guarantees 30 mm safety distance between seal and product, according to DIN rules. Easy to use and maintenance-free, they are the ideal solution for clinics and hospitals. Compatible for sealing with Tyvek rolls and envelopes. Manual in GB, IT.



- 35912 INK-CARTRIDGE D-500/700 - spare part

TECHNICAL SPECIFICATIONS		
	35909	35910
Infeed speed	6 m/min	
Temperature control	by digital thermoregulator	
Sealing temperature	40°±200° C	40°±180° C
Temperature tolerance	±5°C	
Seal	Multiline	
Seal width	12 mm	
Adjustable free edge	0 ÷ 30	
Power supply	230 V-50 Hz-single phase	
Absorption	500 W	600 W
Dimensions	473x235xh 181 mm	
Net weight	11.5 kg	12 kg

## SEALING MACHINES WITH VALIDATION SYSTEM



35915, 35916  
ISO 11607 P.2, ISO/TS 16775  
MADE IN ITALY

- 35915 D-600 ROTARY HEAT SEALER - without printer
  - 35916 D-700 ROTARY HEAT SEALER - with printer
- GIMA 600 and GIMA 700 have been designed to continuously monitor, during the whole sealing phase, all critical process parameters: Temperature, Speed, Pressure. They guarantee sealing in full respect of EN 868-5 / ISO 11607 P.2 rules, provide real-time monitoring of working temperature, applied force and running speed, time used during the sealing process.

All sealing data can be recorded on an external carrier which can be linked to the sealer through a USB port placed on the unit. They are controlled by a microprocessor.

Operator's interface is a clear 2 line display, integrated in an ergonomic keyboard placed at the upper side of the sealer in an user friendly position.

Simple use, high reliability, they are the ideal solution for hospitals and clinics.

Compatible for use with Tyvek rolls and envelopes.

Manual in GB, IT.

- 35912 INK-CARTRIDGE D-500/700 - spare

TECHNICAL SPECIFICATIONS		
	35915	35916
Sealing width	12 mm	12.5 mm
Seal	multiline	
Sealing speed	6 m/min	8.5 m/min
Temperature adjustment/ tolerance	10-200°C ± 5 °C	
Alarms functioning out of tolerance	yes	yes
Automatic stand-by	yes	yes
4 key membrane keyboards	yes	yes
LCD display 2 lines	6 characters	8 characters
Multilingual menu	yes	yes
USB port	yes	yes
Data storage on pendrive	yes	yes
Power	230 V / 50 Hz - single-phase (on request 110 V, 60 Hz)	
Max electrical input:	500 W	500 W
Dimensions - Weight:	473x235x181 mm - 12.5 kg	

## SEAL CHECKER

Dimension:  
175x75 mm

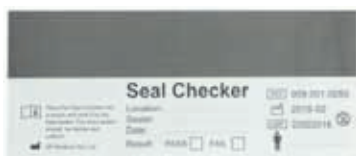

It can display heat sealer problems:  
- too low sealing temperature  
- too low sealing pressure  
- seal interruptions

Suitable for all rotary heat sealers

- 35957 SEAL CHECKER - box of 250 pcs
- The ISO-11607 standard is specifying a routine, daily check of your heat sealers. The seal checker is a way to perform the test required and to document which sealer, which day, which person did perform the test and to easily show results of your heat sealer capacity of properly heat seal your pouch. When place inside a pouch and seal, the sealed area will be darker and can be easily read whether the seal is consistent, regular and completely without any gaps.

## 3M™ ATTEST™ INSTRUMENT PROTECTOR

- 35964 3M™ ATTEST™ INSTRUMENT PROTECTOR 5x12.5 cm 13911 - box of 1000
- 35965 3M™ ATTEST™ INSTRUMENT PROTECTOR 8.9x16.5 cm 13913 - box of 1000

Designed to cover the pointed and cutting edges of surgical instruments in steam or ethylene sterilization. Reduces the possibility of pouch puncture during sterilization. Indicators on the protectors verify steam or EO gas processing.



Scissors not included





## D-351 SEALING MACHINE: ELECTRO-MAGNETE OPERATION

CONFORM TO  
DIN 58953 P.7



Electromagnet closing

MADE IN ITALY

• **35900 D-351 IMPULSE SEALING MACHINE**  
Compact impulse medical sealers, designed to be used in medical, dental, oculistic surgeries and test laboratories.  
**Main features:** sealing and cutting length 35 cm - Safety check with alarm. Main board with temperature control to

avoid overheating of the sealing wire - Sealing bars closed by electromagnet. Complete with foil-roll dispenser and built-in cutting device.

**Easy:** the bars close automatically by the pressure of one finger. The electro-magnet guarantees a steady sealing pressure for the whole set period. The sealing bar opens automatically at the end of the cycle.

**Quick:** the electro-magnetic system allows a substantial saving of the packing time. Quick foil feeding.

**Safe:** the machine does not start the sealing cycle if there is an object with a thickness over 3 mm between the bars.

The electronic temperature control through a NTC probe provides a perfect temperature accuracy from seal to seal. The electronic alarm function avoids any overheating.

• **35902 TEFLON - spare** • **35903 RESISTOR - spare**

### TECHNICAL SPECIFICATIONS

Sealed materials: paper/polyethylene/polyester  
Sealing length - width: 350 mm - 8 mm as per DIN 58953-7:2010  
Electronically controlled sealing time: 0.5 sec.  
Cutting length: 350 mm Foil-roll dispenser 350 mm  
Power: 230V- 50/60 Hz single - phase  
Max absorption: 900W, only during the sealing time  
Dimensions: 44x17.5x31 cm Weight: 18 kg

## GD-301 EVO SEALING MACHINE FOR CONTINUOUS HEAT SEALING

MADE IN ITALY



35929

### TECHNICAL SPECIFICATIONS

Flat sealing 12 mm	Sealing length 300 mm
Thermo controlled continuous heat sealing	
Built-in cutting device	Fixed sealing temperature and time
Manual actuation	Power 230 V / 50-60 Hz, single phase
Electrical input: 900 W	Protection degree IP 20
Sealer dimensions 452x248x146 mm	Roll-holder dimensions 458x412x242 mm

• **35928 GD-301 EVO SEALING MACHINE - machine only**

• **35929 GD-301 EVO SEALING MACHINE - complete**

Manual heat sealer for medical pouches and reels according to DIN 58953-7:2008. **3 ceramic heater** elements for a faster and more accurate sealing and **improved infeed and outfeed guide** to keep film flat (infeed) and prevent the film moving upward inside machine.

Available in 2 versions: compact without accessories (35928) or with sealer roll holder, cutter and plane (35929). User friendly, reliable and extremely compact, ideal in dentistry, medical and veterinary laboratories. Sealing bar 300 mm manually actuated by a lever. Thermo controlled continuous heat sealing, to save consumables. Compact vertical design to reduce space. Integrated, removable roll-holder, can stand alone apart from the sealer. Usable only with polypropylene film coupled to medical grade paper and/or plastic envelopes suitable for steam sterilization.

• **35933 CERAMIC HEATING ELEMENTS - spare**

• **35935 BLADES - kit of 5 - spare**

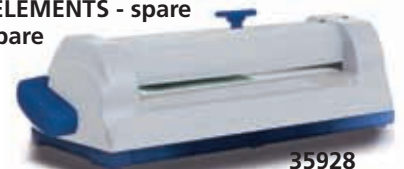

35928

## TRACKING SYSTEM DOCUMENTATION: 2 LINE LABELER

### TRACEABILITY/DOCUMENTATION

The traceability system of the instruments provides a proper and easy handling of sterilized materials. This system tracks each instrument, from the preparation to the sterilization and to its final use. The combined use of Labeler and Labels will give you a complete and essential data system for the safeguarding of each healthcare operator.

- easy print of identical labels with minimum time and effort
- it eliminates mistakes in batch numbers
- easy interpretation of the results due to precise colour change
- no need for additional process indicators using our labels with indicator

• **35980 2 LINE MEDICAL LABELER 14+14 DIGITS**

Reliable, easy to use and durable, it allows to print all requested information on the labels: lot No, sterilizer/cycle No, sterilization date and expiry date.

• **35984 2 LINE STEAM LABEL - box of 12,000 (24 rolls of 500 labels)**

First print line can display: 3 alphabetic digits + 11 numbers

Second print line can display: 14 numbers

Steam indicator label, suitable for steam sterilization cycle.

Double adhesive support. After the sterilization cycle the indicator changes from original PINK colour to BROWN.

Process indicator: Steam Standard ISO 11140-1

Class 1, non toxic ink, latex free.

• **35982 INK ROLL FOR LABELER - box of 5**

35982



35980

MADE IN ITALY



35984

Supplied with multilingual manual (GB, FR, IT, ES, PT, DE, GR, PL, RO) and 1 ink roll.

BEFORE STERILIZATION		AFTER STERILIZATION	
Lot number	STE05 14587	Sterilizer/cycle N	STE05 14587
Sterilization date	21.10.19 21.10.20	Expiry date	21.10.19 21.10.20

We have shown a preferred use of first print line, but user can print alternative information

## ROLLS FOR STERILIZATION BY STEAM OR ETO

**FLAT ROLLS for sterilization by steam or ethylene oxide gas**  
 Made of transparent, polyester-polypropylene film coupled to medical grade paper which permit steam and gas penetration during sterilization. Steam and gas indicators provide clear colour changes when exposed to sterilization process.



**GUSSET ROLLS for sterilization by steam or ETO**  
 Made of coated film PET 12/PP 40 green and 60 g medical white paper.  
 For sterilization of voluminous objects.



FLAT ROLLS FOR STERILIZATION BY STEAM OR ETO - 200 m				
GIMA code		External m x mm	Internal m x mm	Minimum order
35803	Flat rolls	200x50	200x36	box of 8
35804	Flat rolls	200x75	200x53	box of 8
35805	Flat rolls	200x100	200x78	box of 4
35806	Flat rolls	200x150	200x128	box of 4
35807	Flat rolls	200x200	200x178	box of 2
35808	Flat rolls	200x250	200x228	box of 2
35809	Flat rolls	200x300	200x278	box of 2
35816	Flat rolls	200x400	200x378	box of 1

GUSSET ROLLS FOR STERILIZATION BY STEAM OR ETO - 100 m				
GIMA code		External m x mm x mm	Internal m x mm x mm	Minimum order
35825	Gusset rolls	100x100x25	100x78x25	box of 4
35826	Gusset rolls	100x150x25	100x128x25	box of 4
35827	Gusset rolls	100x200x30	100x178x30	box of 2
35828	Gusset rolls	100x250x32.5	100x228x32.5	box of 2
35829	Gusset rolls	100x300x40	100x278x40	box of 2
35830	Gusset rolls	100x400x40	100x378x40	box of 1

## FLAT AND SELF-SEAL POUCHES FOR STEAM OR ETO STERILIZATION

**FLAT POUCHES AND SELF-SEAL POUCHES for sterilization by steam or ethylene oxide gas**  
 Light green, polyester-polypropylene transparent film coupled to medical grade paper which permit steam and gas penetration during sterilization.  
**Steam and gas indicators change colour when exposed to sterilization.**

1. Reinforced corners to prevent dust from collecting near to the opening, reducing the risk of contamination.
2. The laminated transparent film complies with the German standard EN 10/204. The medical paper conforms to: DIN

58953 (German), Pharmacopoeia 589 (French), pr EN 868-3 (European) and BS 6256 (English).

3. The chevrons allow rapid and correct opening.
4. These consist of one layer of laminated transparent film (special type polyester and copolymer polypropylene) and white damp-resistant medical Kraft paper, specially designed to assure a high anti-bacterial protection.
5. The heat-sealed lines (Multiline) are highly resistant and spaced equally; the external welding runs along the entire length of the pouch.

Reels and pouches are certified and manufactured according to DIN 58953 BS 6871, EN 868-5, CN 13485.



FLAT POUCHES FOR STERILIZATION BY STEAM OR ETO				
GIMA code		External mm	Internal mm	Minimum order
35880	Flat pouches	100x300	78x285	1,000
35881	Flat pouches	150x200	128x185	1,000
35882	Flat pouches	150x250	128x235	1,000
35883	Flat pouches	150x300	128x285	1,000
35884	Flat pouches	150x400	128x385	1,000
35885	Flat pouches	200x300	178x285	1,000
35886	Flat pouches	200x350	178x335	500
35887	Flat pouches	200x400	178x385	500
35888	Flat pouches	250x400	228x385	500
35889	Flat pouches	250x500	228x485	500
35890	Flat pouches	300x400	278x385	500
35891	Flat pouches	400x600	378x585	500
35895	Special size pouches			10,000

SELF-SEAL POUCHES FOR STERILIZATION BY STEAM OR ETO				
GIMA code		External mm	Internal mm	Minimum order
35857	Self-seal pouches	90x165	68x150	2,400*
35858	Self-seal pouches	90x230	68x215	2,400*
35859	Self-seal pouches	140x250	118x235	1,600*
35863	Self-seal pouches	190x330	168x315	1,200*
35864	Self-seal pouches	190x400	168x385	1,200*
35866	Self-seal pouches	300x450	278x435	400*

\*Self-seal pouches are packed in box of 200 pouches inside carton

## 3M LITTMANN® STETHO



**3M**  
See page 283-287

*A wide variety of models with optimal sound transmission and excellent acoustics to meet veterinary needs.*

**3M LITTMANN® CLASSIC II - infant/ped.**  
Suitable for small and very small animals.  
**3M LITTMANN® CLASSIC III and CARDIOLOGY IV**  
Suitable for medium and big animals.

## VET PRODUCTS

- **CLOGS**  
See page 35-36
- **TOURNIQUETS**  
See page 76
- **SCALPELS and BLADES**  
See page 61-62
- **THERMOMETERS**  
See page 98-102
- **VET BAGS**  
See page 77-80
- **TROLLEYS**  
See page 146-161
- **BANDAGES, GAUZES, PLASTERS**  
See page 401-409
- **BARRYCIDAL 30 PLUS DISINFECTANT**  
See page 421

## BIOPSY PUNCHES

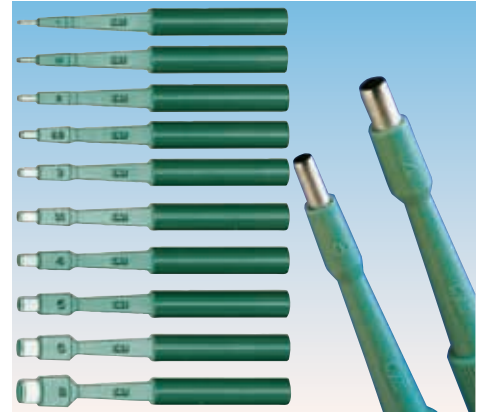

**BIOPSY PUNCHES  
DERMAL CURETTES**  
See page 64.

## SUTURES



**SUTURES AND SKIN STAPLER DEVICE**  
See page 55-60.

## PILL MANAGERS



**PILL PULVERIZERS**  
See page 103-105.

## SUCTION UNITS



**SUCTION UNITS**  
See page 201-205.

## ELECTROSURGERY



**ELECTROSURGICAL UNITS**  
See page 223-228.

## ELECTROSURGERY

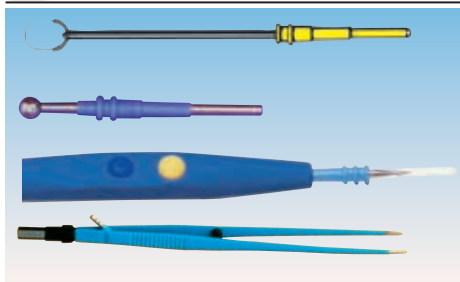

**ELECTROSURGERY ACCESSORIES**  
See page 229-236.

## HEADLIGHTS



**HEADLIGHTS**  
See page 239-242.

## EXAMINATION LIGHTS

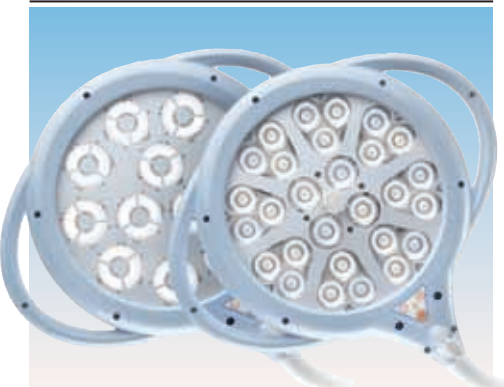

**EXAMINATION LIGHTS**  
See page 243-250.

## COHESIVE BANDAGES



**BANDAGES, GAUZES, PLASTERS**  
See page 401-409.

## SURGEON BRUSHES



**SCRUB KIT: CHLOREXIDINA SCRUB KIT  
IODO-POVIDONE SCRUB KIT**  
See page 420.

# VETERINARY STAINLESS STEEL INSTRUMENTS

## FORCEPS



• **80000** Durante forceps - 15 cm



• **80001** Terza Palpebra forceps - 11 cm



**80002**

• **80002** Long Hartmann micro - 14.5 cm  
• **80003** Vet Hartmann forceps with thin tips - 12 cm

## RETRACTORS



• **80020** Gelpi retractor - 13 cm  
• **80021** Gelpi retractor - 15 cm

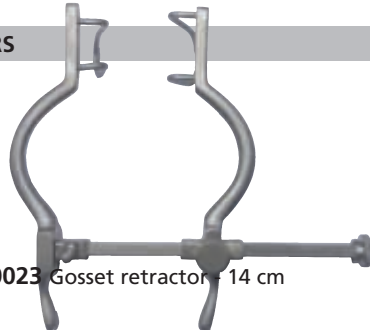

• **80023** Gosset retractor - 14 cm

## DISSECTION SCISSORS



• **80015** Stevens dissection scissors curved blunt/blunt - 11.5 cm

## ORTHOPEDIC INSTRUMENTS - BONE FORCEPS AND ELEVATOR



• **80045** Beyer bone forceps - 18 cm



• **80047** Verbrugge bone forceps - 24 cm



• **80050** Reductive bone forceps - 16 cm  
• **80051** Reductive bone forceps - 18 cm  
• **80052** Reductive bone forceps - 20 cm



• **80054** Hohmann elevator - 24 cm



• **80056** Volkman bone spoon 17 cm - cutting 3-5 mm  
• **80057** Volkman bone spoon 17 cm - cutting 6-9 mm

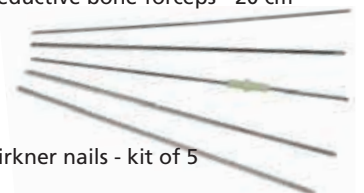

• **80059** Kirkner nails - kit of 5

## DENTAL INSTRUMENTS FOR SMALL ANIMALS



**80007**

• **80005** Mouth opener - 7 cm  
• **80006** Mouth opener - 11 cm  
• **80007** Mouth opener - 15 cm

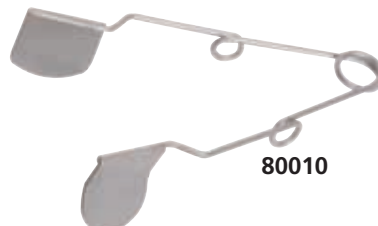

**80010**

• **80010** Rodent mouth opener - 6 cm  
• **80011** Rodent mouth opener - 8.5 cm



• **80012** Extraction curved forceps for small animals - 16 cm

## ANIMAL CARE INSTRUMENTS



• **80025** Cutter for nails for cats and dogs

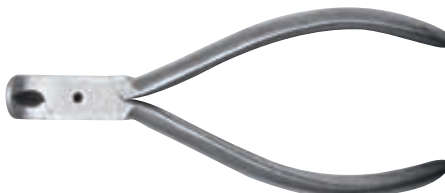

• **80027** Nipper for nails for cats and dogs



• **80029** Pedicure file for small animals



• **80031** Combs for cat/dog

## CASTRATION INSTRUMENTS



• **80035** Hook for cats' castration

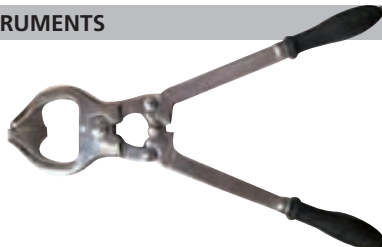

• **80036** Burdizzo castrator forceps - 23 cm

## OPHTHALMOLOGY INSTRUMENTS



• **80040** Castroviejo caliper - 20 cm

## DIGITAL PET SCALES FOR LARGE AND SMALL ANIMALS

**SOEHNLE**



• **80220 SOEHNLE 6858 VETERINARY SCALE**  
 Digital vet scale with large and flat stainless steel weighing platform. Designed for small and medium-sized animals. Quick and easy operation. Easy to read LCD display with 25 mm high digits and aluminium housing. Auto-off function. Hold function and taring function. Supplied with rubber mat and multilingual manual: GB, FR, IT, DE.

**TECHNICAL SPECIFICATIONS**

Capacity: 200 kg      Sensitivity: 50 g  
 Display: 25 mm backlit LCD      Weighing units: kg, lb, oz, lb.oz  
 Size: platform 900x600xh 40 mm - indicator 215x100xh 70 mm  
 Power supply: DC 5V power supply (included) or 4x 1.5 V AA batteries (not included)



• **27258 DIGITAL PET SCALE - medium**  
 • **27259 DIGITAL PET SCALE - large**  
 Precise full electronic multifunctional scale, designed for measuring your pet's weight available in two sizes. Quality product with very competitive price. Minimal measuring weight: 3 kg. Automatic switch-off

MADE IN EUROPE

**TECHNICAL SPECIFICATIONS**

Capacity/Sensitivity: 100 kg / 100 g  
 Display: LCD, 3"  
 Minimum measurable weight: 3 kg  
 Dimensions: 355x635 mm (27258) - 620x830 mm (27259)  
 Lithium battery: included, CR2032, 3 V

**SOEHNLE**



MADE IN GERMANY

Taring functions switchable to kg/lb

• **27266 SOEHNLE 8320 FOLDABLE SCALE**  
 • **27271 CARRYING BAG**  
 Foldable scale with magnetic lock for easy transport. Manual in DE, GB, FR, ES, IT, GR, CZ.

**TECHNICAL SPECIFICATIONS**

Capacity: 15 kg      Sensitivity: 10 g      Weight: 1.9 kg  
 Dimensions: 395x315x105 mm (closed) - 740x315x53 mm (open)  
 Alkaline battery 2x1.5V AAA - not included      Warranty: 2 years



Tray 530x290 mm  
 Lb/kg/st switchable by user  
 LCD display 25 mm

Overload and low battery indication  
 Tare and automatic hold functions  
 Automatic switch-off

• **27261 DIGITAL SMALL PET SCALE**  
**TECHNICAL SPECIFICATIONS**

Capacity/Sensitivity: 20 kg / 5 g  
 Minimum measurable weight: 20 g  
 Tray size: 530x290 mm  
 Lithium battery: CR2032, 3 V (not included)

## DIAGNOSTIC AND OPERATIVE VETERINARY TABLES



Pack size: 121x15x90 cm  
 Size: 120x58xh 85 cm  
 Weight: 23 kg  
 Load: 60 kg

MADE IN ITALY

• **80300 VETERINARY EXAMINATION TABLE**  
 Veterinary operating table with enamelled tubular steel frame, with AISI 304 15/10 stainless steel top with hole and a liquid tray holder underneath. Lateral hook to immobilize animals.



Size: 118x56xh 85/102  
 Weight: 48 kg  
 Max load: 90 kg

MADE IN ITALY

• **80301 VETERINARY OPERATION TABLE**  
 Veterinary operating table with electric lift (82/102 cm), baked enamelled steel tubular frame and AISI 304 stainless steel top (120x56 cm) with hole and a liquid bucket holder underneath. Manual Trendelenburg 15° and Antitrendelenburg up to 15°. Lateral hook to immobilize animals.

## MD SCOPE VET VIDEO OTOSCOPE

- 32164 VET MD SCOPE VIDEO OTOSCOPE WITH 3 PROBES

### Instant View

A clear and sharp image can be acquired and displayed instantly on a built-in screen. Just press a single button and wait for 3 seconds.

### Real Time Interaction

The medical image can be captured and displayed simultaneously on TV monitor or downloaded to Mac/PC system.

### Electronic medical record

A medical image is automatically generated to support most of the stand-alone health information system. Probes and accessories at page 254.

- 32175 CRADLE

### TECHNICAL SPECIFICATIONS

2.4" colour LCD display  
Video out port  
Size/weight: 8x20 cm (2.5"x8") - 218 g  
Battery lifespan: 4 hours

### STANDARD ACCESSORIES

- 3 camera probes 75/150/300 mm
- image dongle
- cable set
- 2 AA alkaline batteries

32175



## HEINE VET OTOSCOPE

- 80500 BETA OTOSCOPE SET 2.5 V - G-112.10.118
- Set complete with slit illumination head, 1 set long closed metal specula (57x4,65x6,90x7 mm), battery handle, 1 spare bulb, hard case.
- 31772 HEINE 077 OTOSCOPE BULB 2.5 V - spare
- 31781 HEINE 069 OPHTHALMOSCOPE BULB 2.5 V - spare



80500



## VET OTOSCOPES, OPHTHALMO AND DIAGNOSTIC SETS



31442

Open otoscope head is supplied with codes 31422, 31424, 31425



31429



31424



31422

31425

- 31442 PARKER VETERINARY OTOSCOPE
- Includes: kit of 3 reusable plastic cannulas (31447)



31447



31451 Suitable for small animals



31453 For open otoscope head

- 31424 XENON HALOGEN DIAGNOSTIC SET
- Includes: xenon halogen open otoscope head+handle, xenon-halogen ophthalmoscope head, kit of 5 reusable plastic cannulas (31451), metal tongue depressor holder illuminator, nasal specula.
- Rechargeable battery handle 2.5 V
- All sets have 2.5 V handle for use with 2xC batteries or rechargeable batteries (34479)



31426

Slit illumination head



Easy adjustable with finger clip

31454

- 31422 XENON HALOGEN OTOSCOPE SET
- Includes: xenon-halogen open otoscope head+handle, kit of 5 reusable plastic cannulas (31451), kit of 3 reusable plastic cannulas (31447)

- 31425 XENON HALOGEN DIAGNOSTIC SET
- Includes: xenon-halogen open otoscope head+handle, xenon-halogen ophthalmoscope head, kit of 3 reusable metal cannulas + 2 metal specula (31453)

GIMA code	VETERINARY SETS AND ACCESSORIES
31451	Kit of 5 reusable plastic cannulas (Ø 2.5, 3.5, 4.5, 5.5, 9 mm)
31447	Kit of 3 reusable plastic cannulas (Ø 4,5, 7 mm)
31453	Kit of 3 reusable metal cannulas (Ø 4, 5, 6 mm) + 2 slotted metal specula (Ø 7.5, 9.4 mm)
31454	Chromed brass nasal specula 79 mm
31478	Xenon halogen otoscope bulb 2.5 V
31479	Xenon halogen ophthalmoscope bulb 2.5 V
31449	Standard otoscope bulb vacuum 2.5 V for 31442
31542	Charging station
34479	Rechargeable NimH battery 2.5 V / 3000 mAh
31429	Swivel lens 2X for Vet oto sets 31422, 31424, 31425
31426	Slit illumination head xenon/halogen for 31422, 31424, 31425

# VETERINARY RI-SCOPE® OPERATION OTOSCOPE AND SETS

- **80480 RI-SCOPE® OPERATION VET OTOSCOPE HEAD 2.5V - 10541 needs 80488**
  - swivel lens with 2.5 X fold magnification
  - moveable, slotted speculum holder can be locked in any position
  - open design for unhindered use during examination and operation
  - bayonet fitting for fast and secure attachment to the handle
  - all-metal operation otoscope for long service life
  - fast exchange of lamp at the front of the otoscope
- **80483 REUSABLE SPECULUM Ø 4 mm - 83 mm - 10881**
- **80485 REUSABLE SPECULUM Ø 6 mm - 82 mm - 10882**
- **80487 REUSABLE SPECULUM Ø 9.4 mm - 92 mm - 10884**
  - high quality, made of chrome-plated, corrosion-free metal
  - matt inner surfaces reduce the risk of reflections
  - slotted model (80487 only): optimum instrument guide provided by special edges on opening
- **80488 HANDLE TYPE AA for 80480 - 10642**
  - Suitable for 2 AA batteries (not included)

**RI-SCOPE® L OPHTHALMOSCOPE (only 80492, 80494)**

- focusing wheel with corrective lenses from 0 to + 40 and 0 to - 35 diopters
- easy-to-operate aperture hand-wheel with semi-circle, small/medium/large circle fixation star, slit and red-free filter with contrast-enhancing effect

All sets supplied in glass-fiber reinforced and sturdy casing.

80480+  
80487+  
80488



## • 80490 VET HALOGEN OTOSCOPE 2.5V AA handle - 3853

Ri-scope® operation otoscope  
Metal specula, unslotted, sterilisable:  
- Ø 4 mm, 83 mm long  
- Ø 5 mm, 62 mm long  
- Ø 6 mm, 82 mm long  
Metal specula, slotted, sterilisable:  
- Ø 7.5 mm, 68 mm long  
- Ø 9.4 mm, 92 mm long  
1 spare lamp  
swivel lens with 2.5 X magnification



80490

## • 80492 VET HALOGEN OTO-OPHTHALMOSCOPE SET 2.5V AA handle - 3861

Ri-scope® operation otoscope, Ri-scope® L1 Ophthalmoscope  
Metal specula, unslotted, sterilisable:  
- Ø 4 mm, 83 mm long  
- Ø 5 mm, 62 mm long  
- Ø 6 mm, 82 mm long  
Metal specula, slotted, sterilisable:  
- Ø 7.5 mm, 68 mm long  
- Ø 9.4 mm, 92 mm long  
2 spare lamps  
swivel lens with 2.5 X magnification

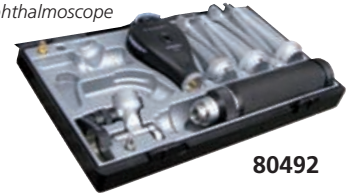

80492

## • 80494 VET DELUXE OTO-OPHTHALMOSCOPE SET 2.5V AA handle - 3869

Ri-scope® operation otoscope, Ri-scope® L1 ophthalmoscope  
Ri-scope® L tongue depressor, Ri-scope® L nasal speculum  
Metal specula, unslotted, sterilisable:  
- Ø 4 mm, 83 mm long  
- Ø 5 mm, 62 mm long  
- Ø 6 mm, 82 mm long  
Metal specula, slotted, sterilisable:  
- Ø 7.5 mm, 68 mm long  
- Ø 9.4 mm, 92 mm long  
2 spare lamps  
swivel lens with 2.5 X magnification



80494

# DIGITAL THERMOMETER

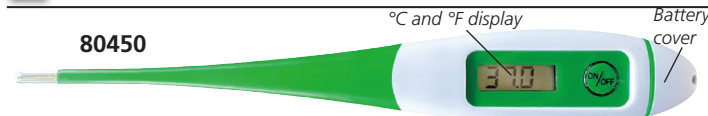

80450

• **80450 VET DIGITAL THERMOMETER**  
- flexible tip, waterproof  
LCD size 15x7 mm  
Multilingual box and manual: GB, FR, IT, ES, PT, GR.

**TECHNICAL SPECIFICATIONS**  
Measurement range: 32~42.9 °C  
Accuracy: ± 0.1 °C  
Dimension: 138x21x10 mm  
Battery: 1.5V LR41  
Measurement time: 60 sec.

# VET STETHOSCOPE

• **32545 REGALITE VET - black**  
Top quality single head stethoscope.  
Chromed plated chestpiece with "SUPERFLEX" inner spring binaural and 1 piece moulded PVC, tubing 90 cm long.  
Supplied in deluxe box, with spare soft eartips and one spare diaphragm.



90 CM LONG Y TUBE



32545

# DIGITAL THERMOMETER



• **25588 VET RECTAL THERMOMETER**  
Designed to be ergonomically correct for animals.  
Setting for pets, pigs, cattle and other animals.  
Features:  
- instant temperature in 16 seconds  
- beeps indicator  
- LCD display and memory  
- automatic shut-off after 10 minutes  
- display temperature in both Fahrenheit or Celsius scale  
- reliable, safe and easy to use  
Multilingual box and manual: GB, FR, IT, ES, PT, GR.

16 SECOND MEASUREMENT

25588

**TECHNICAL SPECIFICATIONS**  
Measurement range: 32~42.9°C (89.6~109.2 °F)  
Accuracy: ± 0.1 °C (35~39°C)  
Battery life is approx. 5,000 readouts  
Dimension: 190x110x35 mm  
Battery: 2x1.5V AAA  
Measurement time: 16 sec.

# VISIOFOCUS® VET - BLUETOOTH

• **80457 VISIOFOCUS® VET - Bluetooth**  
VisioFocus Vet can measure body temperature of animals at a distance in few seconds without touching them. Thanks to the optical aiming system, temperature is taken from the eyes through a LED system that indicates the correct reading distance. The temperature can also be taken from rectum area, auricle or gum. Built-in cap protects from dust and dirt.  
**Automatic adjustment to the environments:** the software automatically applies a correction factor according to ambient conditions, just leaving it for at least 3-5 minutes in the room. Alternatively you can run a manual calibration (**Manual Quick Calibration System, MQCS**) in only 3 seconds.  
**Suitable for all animals**  
**Multipurpose:** used to take also the temperature of objects, food, liquids or other surfaces.  
**Bluetooth system to connect with smartphone:** VisioFocus Vet App helps to choose appropriate animal and record a large number of data.  
Supplied with 4 AAA batteries.



80457

**TECHNICAL SPECIFICATIONS**  
Body measurement range: 32-43.5°C (89.6-110.3°F)  
General measurements range: 1-80°C (33.8-176 °F)  
Resolution (body - general): 0.1°C (0.1°F)  
Dimension: 144x43.5x21.5 mm (5.66x1.71x0.85") including cap  
Battery: 4 AAA - LR03  
Battery life is approx. 3 years or 30,000 measurements  
Measurement time: immediate  
Distance from the animal\*: about 6 cm (2.4 inches)

\*Calculated by an optical aiming system

## VET ELECTRONIC SPHYGMOMANOMETER AND SpO<sub>2</sub>



### • 80550 VET ELECTRONIC SPHYGMOMANOMETER

Electronic sphygmomanometer for automatic measurement of animals blood pressure. Large, high definition colour LCD display.

- data storage for up to 100 groups of data with date and time
- five cuff sizes: small, small/medium, medium, large, X-large
- automatic one-touch operation
- alarm function with possibility to set alarm limits
- dual scales: kPa and mmHg
- automatic power off
- optional SpO<sub>2</sub> probe with clip for tongue or ear

Poor results with small (poor signal) and restless (more artifact) animals.

Supplied with medium cuff (10-19 cm) and multilingual manual (GB, FR, IT, ES, PT)



GIMA code	CUFFS	Size	Suitable for
80551	Small	6-11 cm	Cats, baby dogs,...
80552	Small/medium	10-19 cm	Small dogs, fox, sheep...
80553	Medium	18-26 cm	Baby horses and pigs, big dogs, deers
80554	Large	22-32 cm	Horses, pigs, puma, baby bears, lions
80555	X-Large	32-43 cm	Bears, lions, tigers
ACCESSORIES			
80556	Power adaptor		
80557	SpO <sub>2</sub> probe - optional		
80558	Extension cable 1.5 m for 80557		

TECHNICAL SPECIFICATIONS	
Measurement method:	oscillometric
Measurement range:	0-38.67 kPa (0-290 mmHg)
Resolution:	mmHg
Accuracy: static pressure:	±0.4 kPa (±3 mmHg)
Inflation - Deflation:	automatic inflation - automatic multistep deflation
Display:	2.8" colour LCD screen
Power:	four "AA" batteries or optional power adapter
Safety:	class II device type BF applied part
Dimension - Weight:	130x110x80 mm - 300 g
SpO <sub>2</sub> - optional	
SpO <sub>2</sub> range:	0-100% (resolution 1%)
SpO <sub>2</sub> accuracy:	70%-100%: ± 2%
PR range:	30bpm-250bpm, (resolution 1bpm)
PR accuracy:	± 2bpm or ± 2% (select larger)

## OXY-100 HANDHELD VET PULSE OXIMETER



### • 34343 OXY 100 VET PULSE OXIMETER

OXY 100 Handheld Pulse Oximeter can measure oxygen saturation (SpO<sub>2</sub>) and Pulse Rate (PR) by placing the sensor on a certain part of the animal, such as tongue, ear, leg or tail. It also provides plethysmogram, bar-graph and Perfusion Index display.

- lightweight, small and easy to handle
- data storage with trend review
- two options for measurement on: thin tissue: such as tongue, ear, thick tissue: such as leg, tail.
- up to 384 hours of data memory (with 1/2/4/8 sec. recording interval)
- audible & visual alert for over-limits (limits are adjustable).

Tested for cats and dogs. Not suitable for big or very small animals. See technical specifications page 387

Oximeter is supplied with universal "Y" type SpO<sub>2</sub> probe and three types of adapters: big clip, small clip and rubber wrapper. Each of these adapters allows a different measuring respectively on tongue, ear, leg or tail.

• 34346 UNIVERSAL "Y" type SpO<sub>2</sub> probe - spare includes 3 probe adapters (big clip, small clip, rubber wrapper).

## OXY-50 HANDHELD VET PULSE OXIMETER

### • 80800 OXY-50 VET PULSE OXIMETER

- with software  
Pocket Vet pulse oximeter with colour display for routine check and continuous monitoring use.

- display: 1.77" colour TFT
- resolution: 160x128
- display of pulse waveform
- alarm sound, pulse tone
- record: data can be recorded up to 24 hours
- alarm: adjustable high and low limits
- PC software for transferring real time data.

Supplied with Vet probe, 2 AA batteries, USB cable, PC software (GB, FR, IT, ES, DE, RU, PL) and user manual (GB, FR, IT, ES)

• 80801 SpO<sub>2</sub> VET PROBE - spare



TECHNICAL SPECIFICATIONS	
<b>Pulse rate</b>	
Measuring range:	30 ~ 250 bpm (resolution 1 bpm)
Accuracy:	±2 bpm or ±2%
Average pulse rate:	moving calculate the average pulse rate every 4 cardio-beat's cycle. Deviation between average value and true value does not exceed 1%
Pulse intensity range:	continuous bar-graph display, the higher display indicates the stronger pulse
<b>Device</b>	
Power supply:	DC 3V, < 100 MA
Battery:	dry battery (2AA)
Oxymeter probe:	wavelength: 660 - 905 nm
Dimension - weight:	110x60xh 23 mm - 120g (with battery)
Safe type:	BF Type
<b>SpO<sub>2</sub></b>	
Measuring range:	0~100%, (resolution 1%)
Accuracy:	70~100%: ±2%
Average value:	calculate the average value every 4 measure value deviation between average value and true value does not exceed 1%



## VET TOURNIQUET

- **80150 QUICK RELEASE VET TOURNIQUET**  
Quick release VET tourniquet for small animals.  
Extra slim, ideal for cats and small dogs.
- easy to put on
- practical handling
- smooth and elastic cord
- plastic cord clamp



### TECHNICAL SPECIFICATIONS

Cord clamp size:	43x33x8 mm
Cord size:	200 mm
Weight:	10 g

## ABSORBENT PADS FOR PETS

- **80900 ABSORBENTS PAD FOR PETS 60x60 cm - box of 10**
  - **80901 ABSORBENTS PAD FOR PETS 60x90 cm - box of 10**
- Pads designed for pets with superabsorbent polymer, contained in the inner pulp layer, to retain fluids and help alleviate the onset of bad smells. Practical adhesive tapes positioned on the back side of the pad, to ensure strong fixation to surfaces avoiding any pad shifting. Suitable for physiological needs or involuntary losses of organic liquids due to incontinence or other pathologies.
- anti-odour control
  - 100% PEFC certified cellulose
  - non-toxic & waterproof back sheet
  - hygienic, practical and resistant
- Components: fluff pulp PEFC, tissue PEFC, top sheet made of non-woven polypropylene, back sheet made of PE FILM

### TECHNICAL SPECIFICATIONS

	<b>80900</b>	<b>80901</b>
Weight:	54.3 g	84.2 g
Absorption capacity according to ISO11948-1:	1100 g	1700 g



MADE IN ITALY

## KORA VET MAGNETOTHERAPY

- **80770 KORA VET MAGNETOTHERAPY BASIC KIT**
  - **80771 KORA MAT MATTRESS 64x40 cm**
- Kora is a veterinary device designed for pulsed electromagnetic field (PEMF) therapy. Ideal for reduction of pain and inflammation in pets. Suitable for the treatment of neuropathy, ulcers and diseases of the musculoskeletal system of cats and dogs of any size. Easy to use programmes guarantee a safe and effective therapy for pets. We suggest the use of a single Kora Mat mattress for small and medium-sized animals and use of two mats for large or medium-sized animals, combinable through velcro and connectable to a single device.



**80770**

Kora device

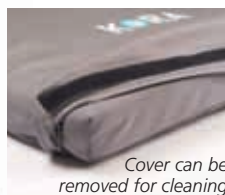

Cover can be removed for cleaning

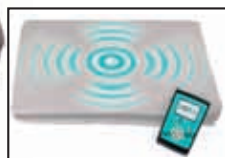

**80770**

+  
**80771**

Combination of 2 mattresses through velcro for large or medium-sized animals

### TECHNICAL SPECIFICATIONS

Channels:	2
Display:	colour display
Magnetic field intensity:	up to 100 G
Frequency:	up to 75 Hz
Programmes:	18
Power supply:	15VDC-2A
Size:	180x110x50 mm

### 18 PROGRAMMES

Analgesic	Sciatic nerve
Arthritis	Neuropathy
Arthrosis	Prostheses
Muscular atrophy	Osteonecrosis
Discopathy	Osteoporosis
Fractures	Treat. 1 Hz
Healing	Treat. 18 Hz
Ligament lesion	Treat. 50 Hz
Tendon lesion	Treat. 75 Hz

<b>STANDARD ACCESSORIES</b>	
Kora Mat mattress	Carrying bag
Power supply	User manual: GB, IT, ES, PT
Magnet for verifying therapy operation	

## COMBISCREEN URINE STRIPS

- **24100 VETERINARY URINE STRIPS - 11 parameters - bottle of 100 strips**
- For examination of glucose, ascorbic acid, ketones, protein, ph-value, blood, nitrite, leukocytes, specific gravity, bilirubin, urobilinogen. Each box includes a manual for interpretation of results of the following animals: horse, pig, cattle, sheep, goat, dog, cat, bunny and guinea pig. Multilingual box and instructions: GB, FR, IT, ES, PT, NL, DE.

ASCORBIC ACID PROTECTED



MADE IN GERMANY

Performs highest quality standard

# VET MONO-BIPOLAR ELECTROSURGICAL UNITS 120W, 160W



80751

- 80750 DIATERMO MB 120D - mono-bipolar - 120 W
- 80751 DIATERMO MB 160D - mono-bipolar - 160 W

MADE IN ITALY

Diatermo MB are high frequency electro-surgical units suitable for minor and medium surgery.

MB allows pure CUT, cut-coagulation BLEND, superficial coagulation FORCED COAG, deep coagulation in absence of necrosis SOFT COAG and, with forceps, BIPOLAR coagulation. The digital reading of delivered power and the monitoring of operative function by microcontroller guarantee absolute reliability of working conditions.

MB allows a highly professional surgery through ergonomic features. Neutral electrode connection and patient/plate contact are constantly monitored.

The possibility of output functions and output power delivery control, by handle, allows surgical procedures without divert attention from operation field.

See accessories (cables, forceps, electrodes, plates, ...) at pages 229-234.

### TECHNICAL SPECIFICATIONS

	MB 120D	MB 160D
Max output power CUT	120 W-250 Ω	160 W-250 Ω
Max output power BLEND	90 W-200 Ω	120 W-200 Ω
Max output power FORCED COAG	80 W-150 Ω	100 W-150 Ω
Max output power SOFT COAG	60 W-100 Ω	80 W-100 Ω
Max output power BIPOLAR	40 W-100 Ω	60 W-100 Ω
Working frequency	600 kHz	600 kHz
Patient circuit	F	F
Selectable input voltage	115 - 230 Vac	115 - 230 Vac
Mains frequency	50 - 60 Hz	50 - 60 Hz
Electrical input power	300 VA	350 VA
Size WxHxD mm	254x104x288	254x104x288
Weight	5 kgs	5 kgs
Controls:	Vet Patient/Plate circuit monitoring, Output power monitoring, Self check control	
Safety:	EN60601-1, EN60601-1-2, EN60601-2-2, Electrical Class: I CF, MDD 93/42/EC Class: II b	

### STANDARD ACCESSORIES

- MB single use two button handle
- MB waterproof foot switch 30577
- MB flat neutral plate with cable (30564)
- Kit of 10 short autoclavable electrodes, Ø 2.4 mm.
- Power cable: 2 m
- User manual: GB, IT, available on request FR, ES, PL

### Features:

- minimum invasive surgery
- possibility to use bipolar forceps
- possibility to use split neutral electrodes
- memorization of the last used settings
- power activation by pedal and/or handle
- digital adjustment and indication of the output power
- adjustment of the acoustic indicator intensity.

# CRYOMEGA® VET DUAL DELIVERY CRYOSURGERY KIT

- 80740 CRYOMEGA® VET DUAL DELIVERY CRYOSURGERY KIT

CryOmega® Vet Dual Delivery is the perfect choice for cryosurgery treatment of benign lesions.

Cryogen reaches a temperature of -68 °C and is immediately ready to use. It can be delivered by cones or buds.

It combines the portability of a canister with the effectiveness found in more expensive liquid nitrogen-based units.

Single handed design, easy to use, no sutures required.

Multilingual manual: GB, FR, IT, ES, DE.

Available GR, RO, NL, BG, SE, PL, PT from [www.gimaitaly.com](http://www.gimaitaly.com)

Effective freezing Anesthesia not required

High efficacy Dual delivery: buds or cones



Type of lesion	Freeze time range
Warts	3 x 10 seconds
Eyelid tumors	10 - 20 seconds
Meibomian gland tumors	10 - 20 seconds
Skin tags	2 x 5 seconds
Distichia	10 seconds
Papillomas	3 x 10 seconds
Adenomas	3 x 10 seconds
Lick granulomas	3 x 10 seconds
Anal growths	3 x 10 seconds

CRYOSURGERY ADVANTAGES
Less time involved
Tissue sparing
Less bleeding
Less post-surgical pain
Less sedation or none required
Minimal cutting or none required

STANDARD ACCESSORIES	
1 canister of cryogen gas	1 cone selection guide
handle and trigger	20 buds
4 cone adapters	1 neoprene practice pad
70 cones (3mm, 5mm, 7mm, 9mm, 12mm)	

80740



### LICK GRANULOMA TREATMENT WITH CRYOMEGA® VET



Before

Day 6

Day 11

# VETERINARY ECG - 1 OR 3 CHANNEL

- 33305 VE-100 - 1 channel ECG
- 33306 VE-300 - 3 channel ECG
- 33336 ECG-Viewer software (GB, IT, FR, ES, RU, PT, PL, TU) for 33306

33306

- complete digital design
- LCD display waveforms, parameter configuration
- high resolution thermal printer
- built in rechargeable Li-Ion battery for 6.5 hours use (AC/DC supply)
- complete digital filter, avoid baseline drift, AC, EMG interfere
- baseline automatically adjustable, optimizes printing position
- selectable auto/manual operation

- Features of VE-300 only**
- 12 leads simultaneous acquisition
  - automatic ECG parameter measurement and analysis
  - support USB ink-jet printer for 12 leads printing
  - 120 patient data storage and transfer by USB flash disk, Ethernet or series port
  - review and management of ECG data on Window PC with software (optional 33336)

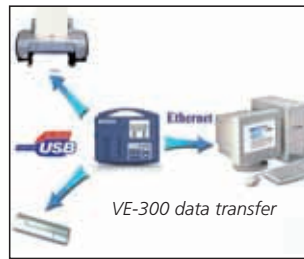

- Internal software: GB, IT (33305/6), DE, FR, ES (33305 only)
- 32963 THERMAL PAPER ROLL 50mm x 25m for 33305
  - 32964 THERMAL PAPER ROLL 80mm x 25m for 33306
  - 33318 RE-CHARGEABLE LITHIUM BATTERY 2200 mAh
  - 33319 5-LEAD VETERINARY ECG CABLE - spare

**STANDARD ACCESSORIES**

- 1 Paper roll
  - Rechargeable lithium battery (2,200 mAh)
  - 5-lead veterinary ECG cable (Ø 4 mm, banana connector, IEC)
  - Veterinary clip electrodes (set of 5, match Ø 3-4 mm ECG cable)
  - Manual: GB, IT - on request FR, ES, DE
- 33319

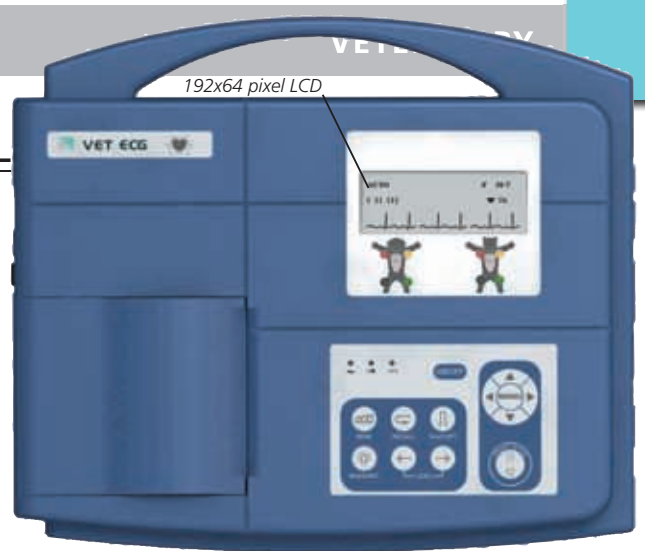

TECHNICAL SPECIFICATIONS		
	33305	33306
Lead	One lead	standard 12 lead
Acquisition mode	One lead	12 leads simultaneously
Frequency response	0.05 Hz ~ 150 Hz	
Sensitivity	2.5, 5, 10, 20 (mm/mV)	
Input impedance	≥ 50 MΩ (10 Hz)	
Filter	EMG Filter 35 Hz (-3dB) AC/DFT Filter 50/60Hz (-20dB)	EMG Filter 25/35/45Hz / OFF DFT Filter 0.05/0.15/0.25/ 0.32/0.5/0.67 Hz Low pass Filter 150/100/75 Hz AC Filter on/off
Recording mode	Auto/Manual	Auto/Manual/Rhythm/OFF/USBPRT
Safety standard	IEC I/CF	
Power supply	AC: 100-115 V, 220-240 V, 50/60 Hz Built-in rechargeable Li-ion battery: voltage 14.8 V More than 6.5 hrs, continuously operation under battery supply	
Thermal paper	50 mm x30 m	80 mm x20 m
Paper speed	25/50 mm/s (± 3%)	5/6.25/10/12.5/25/50 mm/s (± 3%)
Size	300x260x75 mm	
Weight	2.3 kg (with battery)	2.5 kg (with battery)
Display	192x64 pixel LCD	
External input/output	Input: ≥100 kΩ; Sensitivity: 10 mm/V ± 5% Output: ≤100 kΩ; Sensitivity: 1 mm/V ± 5%	
Communication interface	RS232	Ethernet, RS232, USB

# VET DIGITAL 3 CHANNEL ECG



**CONTEC™**

- 80650 3 CHANNEL ECG 300G VET - monitor up to 12 channels
- ECG300G-VET can collect 12 lead ECG signal simultaneously and print waveform by thermal printing system. It records and displays ECG waveform in AUTO or Manual mode, measuring and diagnosing ECG waveform parameters automatically.
- Sync collection, digital signal processing technology to get high quality ECG waveform via power frequency filter, baseline filter and EMG filter of ECG signal
- display of 12 lead ECG, print mode, sensitivity, paper speed and filter state etc. on one screen
- multiple printing modes and formats, including auto and manual; waveform length can be adjusted through timed print function
- built-in large capacity memory to store at least 1,000 cases
- multilingual interface and report: GB, FR, IT, ES, PT, DE, PL, BG, SI, SK, RS, UA, TR (RU, NE, CN, VN)
- 33226 RECHARGEABLE BATTERY - spare
- 32969 PAPER ROLL 80 mm x 20 m - box of 10
- 33228 CARRYING BAG 39x29x14 cm
- 80653 5-LEAD VET ECG CABLE - spare
- 80654 ECG VETERINARY CLIP X 5 for mouth and paw - spare

TECHNICAL SPECIFICATIONS		
ECG instrument Input	Safety Type: Class I, type CF applied part	A/D conversion: 12 bit
	Lead: Standard 12 leads	Time constant: ≥ 3.2 s
	Input way: Floating and defibrillation protection	CMRR: > 105 dB
	Patient leak current: < 10 μA	Enduring polarization voltage: ± 500 mV
	Sampling rate: 1,000 Hz	Noise level: ≤ 12 μVp-p
	Frequency response: 0.05~150 Hz (-3 dB, + 0.4 dB)	
Dispose Wave Data	EMG interference filter: 25Hz/35Hz (-3 dB)	
	AC filter: 50Hz/60Hz (-20 dB)	
Waveform output	Recording way: Thermal printing system (32 spots/mm)	
	Recording paper: 80 mm(W)×20 m(L)	
	Paper speed: 12.5 mm/s, 25 mm/s, 50 mm/s, ± 5%	
	Sensitivity: 5, 10, 20 mm/mV, ± 2% accuracy	
	Auto record: record setup according to auto record format and mode, automatically changes leads, measures and analyzes	
	Rhythm record: record setup according to rhythm record format and mode, automatically measure and analyze	
	Manual record: record according to manual record format	
Power supply	AC: 110-240V, 50/60 Hz	
	DC - Lithium battery: 7.4V, 3500 mAh rechargeable lithium battery	
Fuse	2 pcs φ5×20mm AC time lag; T250 mA / 250 V (Power Supply: 220 V)	
Form	Size - Net Weight: 315 x 215 x 77 mm - 1.6 kg	



- 33228
- STANDARD ACCESSORIES**
- ECG cable 5 lead
  - 5 metal clamps
  - Chest electrodes - 1 set
  - Ground wire
  - Power cord
  - Paper roll
  - Manual: GB, IT

# CMS 8000 MULTIPARAMETER VET MONITOR

ECG+RESP+SpO<sub>2</sub>+  
NIBP+TEMP+PR

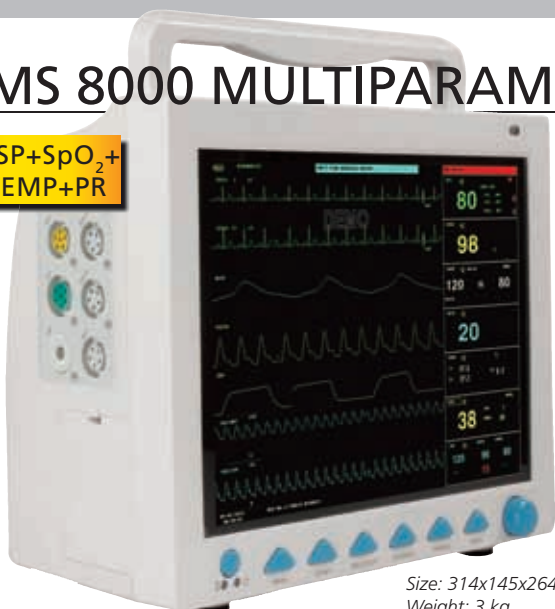

80700

Size: 314x145x264 mm  
Weight: 3 kg

### TECHNICAL SPECIFICATIONS

**ECG**  
5-lead, dual channel, 3-lead, single channel  
Scan speed: 12.5, 25, 50 mm/s  
ST segment monitoring  
Measurement and alarm range: -2.0 mV ±2.0 mV

**RESP**  
Method: R-F (RA-LL) impedance  
Measurement and alarm range: 0-150 rpm  
Apnea alarm: 10-40 sec

**NIBP - Oscillometric method**  
Mode: manual/AUTO/continuous  
Measurement interval in AUTO mode: 1/2/3/4/5/10/15/30/60/90/120/240/480/960 min

Measurement period in CONT mode: 5 min  
Measurement alarm: 10-270 mmHg

**SpO<sub>2</sub>**  
Measurement and alarm range: 0-100%  
Measurement accuracy: 70-100% ±2%

**PR**  
Measurement and alarm range: 25-250 bpm

**TEMP**  
Measurement and alarm range: 0-50 °C

**DEVICE**  
Power supply: 100-240 V - 50/60 Hz  
Safety classification: Classe I type CF  
Defibrillation-proof applied part

### • 80700 CMS 8000 VET PATIENT MONITOR

- ECG, RESP, SpO<sub>2</sub>, PR, NIBP, TEMP
- 12.1" TFT colour LCD display
  - multilingual interface (GB, IT, FR, DE, ES, PT, NL, PL, CZ, TR, RO, RU)
  - 8 channel waveform synchronous display
  - 7 lead ECG waveform on one screen
  - anti-motion, anti-ambient light interference digital SpO<sub>2</sub> technology
  - AC/DC rechargeable lithium battery
  - manual/AUTO/continuous NIBP measurement mode
  - standard/OXY- graph/Trend-graph/big characters and view bed interfaces

GIMA code	ACCESSORIES AND SPARES
80702	Vet SpO <sub>2</sub> probe - 3 m cable - spare
80704	NIBP cuff 6-11 cm - spare
80705	NIBP cuff 10-19 cm - optional
35113	NIBP cuff 18-26 cm - optional
35146	NIBP cuff 25-35 cm - optional
35147	NIBP cuff 33-47 cm - optional
35181	Rectal temp probe - spare
35183	5 leads VET ECG cable - spare
80654	ECG VET clip x 5 for mouth and paw - spare
35157	Printer - optional*
35158	Trolley
35161	Rechargeable lithium battery - spare
32968	Printer paper roll 50 mm x 20 m

Adjustable height  
104-130 cm



\*Installation done by Gima if ordered with monitor. Needs service if ordered later.

### STANDARD ACCESSORIES

- Vet SpO<sub>2</sub> probe - 3 m
- NIBP cuff 6-11 cm and extension tube
- Temperature probe - rectal
- Rechargeable lithium battery
- 5 leads ECG cable with metal clamps
- power supply cable
- manual: GB, IT

# GIMA 900 VET MULTIPARAMETER MONITOR

### • 80710 GIMA 900 VET MULTIPARAMETER MONITOR 80710

Multi-parameter Vet device which can monitor the vital physiological parameters: non-invasive blood pressure (NIBP) and pulse oxygen saturation (SpO<sub>2</sub>).

- 3.5" LCD display for remote review
- flexible configurations of SpO<sub>2</sub> and NIBP
- history data records reviewed in waveform, list and trend graph
- USB connection for data output and software upgrade

80710



35128

35127

GIMA code	ACCESSORIES AND SPARES
80712	Vet SpO <sub>2</sub> probe - spare
80715	NIBP Suntech Vet cuff 6-11 cm - spare
35133	Printer* - optional
35141	Paper 5.1 cm x 12 m - box of 5
35129	Lithium re-chargeable battery - spare
35127	Trolley - adjustable 73 to 113 cm
35128	Rail clamp - optional

80710

### TECHNICAL SPECIFICATIONS

**NIBP**  
Measurement mode: Manual, Auto, STAT  
Measurement range: SYS mmHg 40-265  
MAP mmHg 27-222  
DIA mmHg 20-200

**SpO<sub>2</sub>**  
Measuring range: 1%~100%  
Measuring accuracy: 2% for range 70 to 100%

**Pulse Rate**  
Measuring range: 30~400 bpm

**Other Specifications**  
Power supply: 100-240 VAC, 50/60 Hz  
Battery: 11.1 V / 4,400 mAh (Li-ion Battery)  
Size: 168x172xh 242 mm



80710

### STANDARD ACCESSORIES

- VET SpO<sub>2</sub> probe
- NIBP VET Suntech cuff set (5 cuffs\*\*)
- Lithium rechargeable battery
- Power supply cable
- Dust protective mantle
- Manual (GB, IT)

\*Installation done by Gima if ordered with monitor. Needs service if ordered later.

\*\*Set of 5 cuffs: 3-6 cm, 4-8 cm, 6-11 cm, 7-13 cm, 8-15 cm

# BM3 PORTABLE MULTIPARAMETER VET MONITOR

33719

ECG+SpO<sub>2</sub>+NIBP  
+RESP+TEMPERATURE



3-lead ECG clip



SpO<sub>2</sub> sensor



### • 33719 BM3 VET MONITOR - 7" TFT display

Versatile, portable, lightweight, BM monitor designed to be used in veterinary environment. Compact design and handle make it easy to move. Colour monitor displays all vital signs in different colours for easy recognition. A built in printer offers hard copy documentation of all measured values. Alarms and settings are easily adjustable. See all specifications and accessories at page 349.

### • 33772 RECTAL TEMPERATURE SENSOR - 2.75 m cable

### STANDARD ACCESSORIES

- 3 lead VET patient cable (ECG)
- Disposable electrodes: 10 pcs
- NIBP tubing - 3m
- Set of 3 veterinary cuffs
- SpO<sub>2</sub> sensor - reusable
- SpO<sub>2</sub> sensor extension cable 2 m
- Thermal printer 58 mm
- DC adaptor (18 VDC, 2.5A)
- Battery
- User manual: GB, IT

# CHISON ECO2 AND ECO3EXP. VET DIGITAL ULTRASOUND SYSTEMS



Adjustable monitor with 30° rotation



ECO3EXP. VET With PW (pulse doppler)



- 33945 CHISON ECO2 VET with 1 probe connector without probe
- 33995 CHISON ECO3EXP. VET with 2 probe connectors without probe

- ultra-compact and ultra-light weight, easy to carry
- latest LED screen technology, super bright images allow to easily view scan even outdoor.
- ergonomic monitor design, 30 degree rotation, adjustable.
- ultra-long battery life up to 2 hours, for outdoor scanning
- one-key to enlarge image to full screen, easy to view from distance
- streamlined workflow, easy to operate, 6-one-key to finish the cycle of diagnosis.

### Display modes and imaging processing

B, B/B, 4B, M, B/M, PW (ECO3EXP. only) multi-frequency imaging

### Imaging processing

- compound Imaging
- l-image intelligent image optimization
- THI (Tissue Harmonic Imaging)
- SRA (Speckle Reduction Algorithm)
- full digital beam-former
- full screen display
- trapezoidal
- automatic PW trace (ECO3EXP. only)
- Chroma
- AIO (Automatic Image Optimization)

### User interface

- fold-up control panel and alphanumeric keyboard
- back-lit keyboard for good visibility in dark room
- interactive back-lighting
- indicator lights identify activated keys
- 8 TGC slides for easy adjustment
- short cut knob for quick adjustment (hot key user- defined)
- neat and clear keyboard layout, doctor can remember easily
- user defined preset

### Streamlined workflow, one key to:

- select desired application with automatic preset
- optimize the image automatically (AIO)
- save still image and CINE loop
- print to PC printer\* (laser or inkjet) or video printer
- Make report
- Measure

\*See list of compatible printers on our website

### EASYVIEW™ Archive system

- image archive on hard disk and USB mobile storage
- 3 USB ports
- multiple image formats: BMP, JPG, DCM, CIN, AVI
- cine review: auto, manual (auto review segment can be set) for 2D, M, PW (ECO3EXP. only) images
- cine memory capacity (256 frames/10s)

## ECO2 VET

### STANDARD PACKAGE

	ECO2	ECO3EXP.	ECO5
12" high resolution LED monitor - B&W	•	•	•
12" high resolution LED monitor - colour	•	•	•
8G memory card	•	•	•
Hot Key	•	•	•
PC printer connection	•	•	•
3 USB port	•	•	•
1 ethernet port	•	•	•
1 video out port, 1 VGA out port	•	•	•
1 footswitch port	•	•	•
Full screen display	•	•	•
2 hours rechargeable lithium-ion battery	optional	•	•
Power adaptor	•	•	•
Standard software package	•	•	•
Easy View image archive system	•	•	•
THI	•	•	•
PW (doppler function to detect blood flow speed)	•	•	•

### TECHNICAL SPECIFICATIONS

Dimension and weight: 33.5x15.5xh 35 cm (13.2"x6.1"xh 13.8"); 6 kg  
 Display: 12" LED, high resolution 1,024x768  
 Power: AC 100-240 V - 50/60 Hz  
 rechargeable lithium-ion battery (ECO2 optional, ECO3EXP. standard)

### LANGUAGE - switchable by user

	GB	IT	FR	ES	DE	CZ	TR	CN	RU
Software	•	•	•	•	•	•	•	•	•
User manual	•	•	*					*	

\*On request

# CHISON ECO5 VET COLOUR DOPPLER DIGITAL ULTRASOUND SYSTEM



ECO5 VET 34008



- 34008 CHISON ECO5 VET Colour Doppler 12" high resolution colour LED monitor, 8G high speed memory, 3 USB ports, 2 probe connectors, EASYVIEW™ archive system, without probe

### Imaging processing:

- MCI (Multiple Compound Imaging)
- i-image intelligent image optimization
- THI (Tissue Harmonic Imaging)
- SRA (Speckle Reduction Algorithm)
- full digital beam-former
- trapezoidal
- automatic PW trace
- Chroma
- full screen display model
- AIO (Automatic Image Optimization)

### Other specifications as ECO3EXP.

### TECHNICAL SPECIFICATIONS

Dimension and weight: 33.5x15.5xh 35 cm (13.2"x6.1"xh 13.8"); 6.5kg  
 Display: 12" LED, high-resolution colour 1,024x768  
 Power: AC 100-240 V, 50-60 Hz  
 Rechargeable lithium-ion battery

# PROBES AND ACCESSORIES FOR CHISON ECO SERIES

PROBES ECO1 - 2 - 3 - 5				FREQUENCY(MHz)		Main application				
GIMA code	CHISON code	Scanning method	Main freq.	Probe band width	CANINE	FELINE	OVINE	EQUINE	BOVINE	
33998	C3-A	Convex	3.5	2.5 - 5.0						
33999	L7M-A	Linear*	7.5	5.3 - 10.0	•	•	•	•	•	
33871	L7S-A	Linear**	9.0	5.3 - 11.0	•	•	•	•	•	
34000	L7V-A	Trans-rectal	7.5	5.3 - 10.0			•	•		
33997	MC6-A	Micro-convex	6.0	4.5 - 8.0	•	•				
33874	MC3-A	Micro-convex	3.0	2.5 - 5.0	•	•	•	•	•	

\*With 40 mm footprint, general linear probe

\*\*With 30 mm footprint for superficial tissue exams with higher resolution

GIMA code	ECO SERIES ACCESSORIES
33869	Rechargeable lithium-ion battery BT-2500 (2.5 hours)
33867	ECO trolley TR-9000
33868	Carrying case
33866	Needle guided brackets - specify for which probe (available for 33998-9, 33874 only)
PRINTERS	
33968	SONY UP-X898 MD B&W printer (for ECO1, ECO2, ECO3EXP.)
33993	SONY UP25MD colour printer(for ECO5)



## HEAD AND BRAIN



• **40010 HEAD DISSECTION - life size**  
Size: 18x25x23 cm - 140 g - 4 parts - 1X

Life size

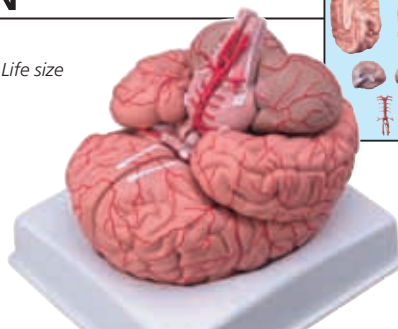

Can be divided into 9 parts showing the temporal and occipital lobes, the frontal and parietal lobes, the cerebellum, the brain stem and basilar artery

• **40020 BRAIN WITH ARTERIES**  
Size: 16x18x16 cm - 1 kg - 9 parts - 1X

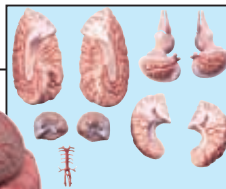

Life size brain with distinct colour for: frontal lobe, parietal lobe, occipital lobe, temporal lobe, motor cortex, somatosensory cortex, limbic cortex, cerebellum, brain stem

• **40021 REGIONAL BRAIN**  
Size: 20x17x15 cm - 1.3 kg - 2 parts

## SENSE ORGANS: EYE AND EAR

These models show the external, middle and inner ear. The eardrum with malleus, incus and stapes are removable. Also cochlea and labyrinth with vestibular and cochlear nerves and 2 bones sections (40042 only) that define the middle and inner ear are removable.



40041-40042

GIMA code	EAR SIZES	Kg	Parts	Mag
40041	33x23x21 cm	1	3	3X
40042	33x23x21 cm	2	5	3X

Cornea, iris, lens and vitreous body can be removed.

40030  
Assembled

40030  
Disassembled



40031  
40033

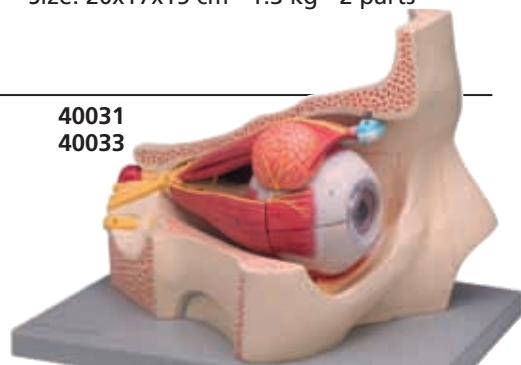

Models show the eye ball with optic nerves and muscles in its natural position in the bony orbit

GIMA code	EYE WITH ORBIT SIZES	Kg	Parts	Mag
40030	15x17x27 cm	0.9	6	6X
40031	42x30x31 cm	3.2	4	5X
40033	42x30x31 cm	3.4	11	5X

## RESPIRATORY SYSTEM: NASAL CAVITY, LARYNX



3x life size, the model shows a medial section of the nasal cavity. The nasal septum and part of the olfactory epithelium are removable to show deep internal structures.

• **40056 NASAL CAVITY**  
Size: 15x20x30 cm - 1 kg - 3 parts - 3X  
Mounted on base with stand.

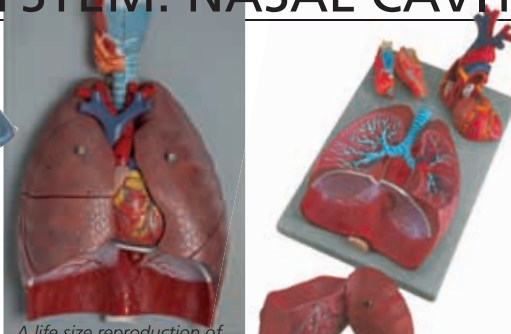

A life size reproduction of the complete human respiratory system. It is composed of 7 parts showing the larynx (dissected along the sagittal plane), the lungs (dissected along the frontal plane) and a 2-part heart.

• **40050 RESPIRATORY SYSTEM**  
Size: 26x40x12 cm - 1.3 kg - 7 parts life size

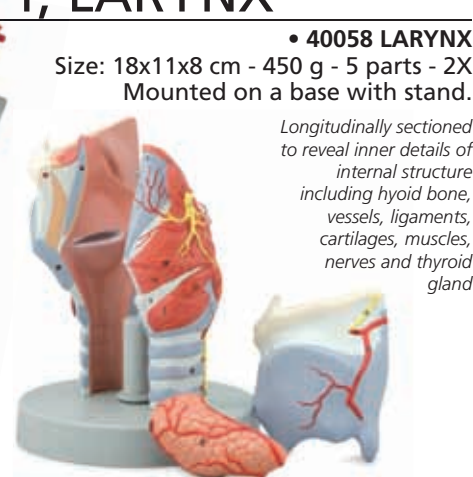

• **40058 LARYNX**  
Size: 18x11x8 cm - 450 g - 5 parts - 2X  
Mounted on a base with stand.

Longitudinally sectioned to reveal inner details of internal structure including hyoid bone, vessels, ligaments, cartilages, muscles, nerves and thyroid gland

## DIGESTIVE SYSTEMS: LIVER, PANCREAS, STOMACH

This model, 15x life size, shows the liver and gallbladder in open section with the complex network of vessels and bile ducts, displayed in different colours to clarity and ease of examination.

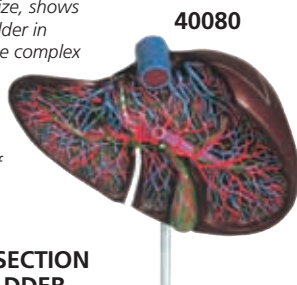

• **40080 LIVER SECTION WITH GALLBLADDER**  
Size: 28x27x14 cm - 880 g - 1 part - 1.5X  
Mounted on a base with stand.

Accurate representation of the pancreas, spleen and duodenum. The pancreas is open to show the entire pancreatic duct. The duodenum is partially dissected to expose its internal structure.

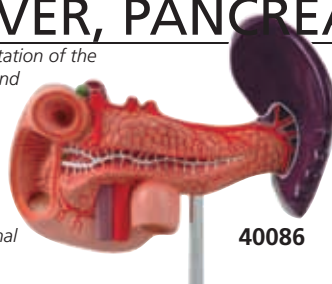

• **40086 PANCREAS, DUODENUM AND SPLEEN**  
Size: 16x15x23 cm - 350 g - 1 part - 1X  
Mounted on a base with stand.

Can be opened to show the internal structure of the stomach, including the mucosa, the pylorus, and a section of the gastric wall. Superficial dissection exposes the longitudinal, circular and oblique muscle layers, with nerves and vascular structures

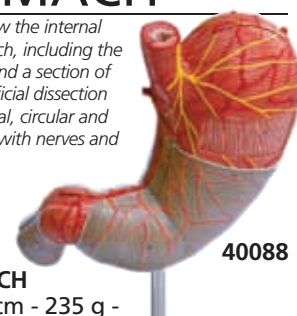

• **40088 STOMACH**  
Size: 16x14.5x5 cm - 235 g - 2 parts - 1.5X  
Mounted on a base with stand.

# HEART AND CIRCULATORY SYSTEM

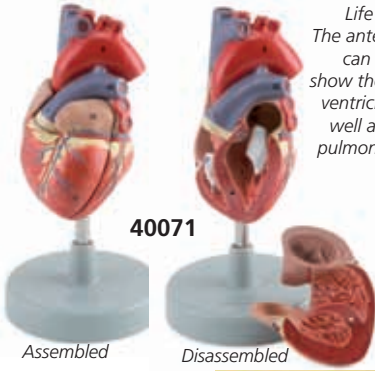

Assembled Disassembled

Enlarged 2000 times, this model shows the various types of blood cells, including red blood cells, white blood cells (lymphocytes, monocytes, neutrophils, eosinophils and basophils) and blood platelets.

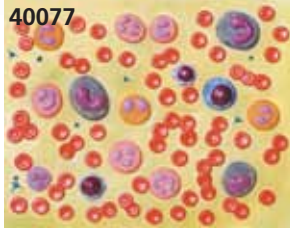

40077

Life size in 2 parts. The anterior heart wall can be removed to show the left and right ventricles and atria as well as the tricuspid, pulmonary, mitral and aortic valves.

Show internal structures including the cardiac valves and the comparative morphology of the right and left ventricles. The right atrium is also removable.



40072

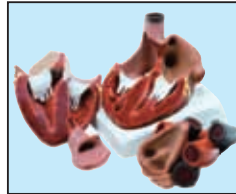

A general view of the human circulation. It includes the heart (2 parts), lungs, liver, spleen, kidneys and relevant connections with the pulmonary and systematic circulatory pathways.



40075

GIMA code	HEART AND CIRCULATORY SYSTEM	Size cm	Weight kg	Parts	Magnif.
40071	HEART - mounted on base	11x7x10	0.23	2	1X
40072	GIANT HEART - mounted on base	24x25x28	3.5	4	3X
40077	BLOOD CELLS - mounted on board	58x38x7	1.0	1	2000X
40075	VASCULAR SYSTEM - mounted on board	90x32x11	2.3	2	0.5X

# URINARY SYSTEM: MALE BLADDER, KIDNEY

## 40090 MALE URINARY BLADDER WITH PROSTATE

Size: 27x20x15 cm - 1,2 kg - 2 parts - 3X

This model, enlarged 3 times, shows the male urinary bladder with the prostate gland surrounding the urethra. The model is dissected medially to expose both internal and external structures of the bladder and prostate, including the ureteric and urethral orifices, ductus deferens, seminal gland, ejaculatory duct.



40090

## 40094 KIDNEY WITH ADRENAL GLAND+RENAL CORPUSCLE

Size: 40x15x8 cm - 1,2 kg - 1 part - 3X

This model shows a frontal section of the human kidney enlarged 3 times. The kidney is shown with the renal capsule. Additional structures include: the cortex, medulla, pyramids with papillae, partially dissected renal pelvis, renal calices, ureter, blood vessels, suprarenal gland with cortex and medulla. A schematic representation of the renal corpuscle with the system of collecting tubules is included.

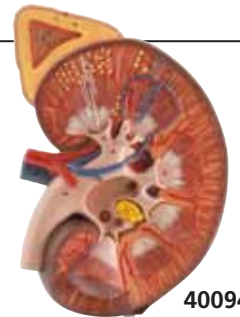

40094

# PELVIS - FEMALE AND MALE

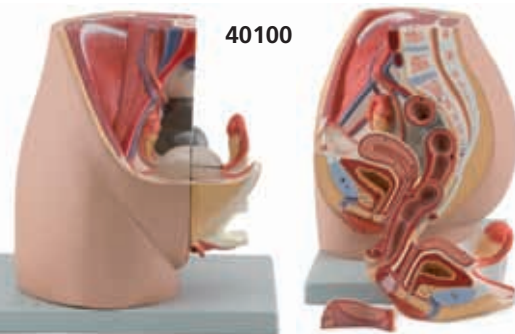

40100

This life size model, composed of 3 parts, shows an open dissection through the median sagittal section of the pelvis. Internal structures of the female urogenital system are portrayed in great detail. Removable parts include half of the female reproductive system with the uterus opened to reveal medial and transverse sectional views.

This life size model, composed of 4 parts, presents an open view through a median sagittal section of the pelvis. Internal structures of the male urogenital system are represented in fine detail. The removable parts include a half penis divided into medial and transverse sections, and half of the male reproductive

40105

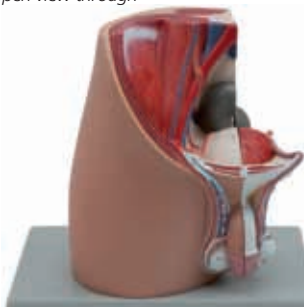

GIMA code	PELVIS size cm	Sex	Kg	Parts	Mag
40100	30x20x27	fem	1.7	3	1X
40105	30x20x27	male	1.7	4	1X

# PREGNANCY PELVIS

This life size model depicts the female human pelvis in median section with a fetus in the 40th week of pregnancy. The fetus is in the normal position prior to birth, showing the anatomical relationship between various structures of the maternal pelvis and the



## 40110 PREGNANCY PELVIS WITH MATURE FETUS

Size: 40x26x34 cm - 3.3 kg - 2 part - 1X

# SKIN

## 40061 SKIN MODEL - 30X

Size: 20x15x15.5 cm - 1.2 kg  
Mounted on base

All the skin layers can be easily identified and the main structures such as hair follicle, sensitive corpuscles, sebaceous and sweat glands, are numbered and referred on the accompanying k-card

40061

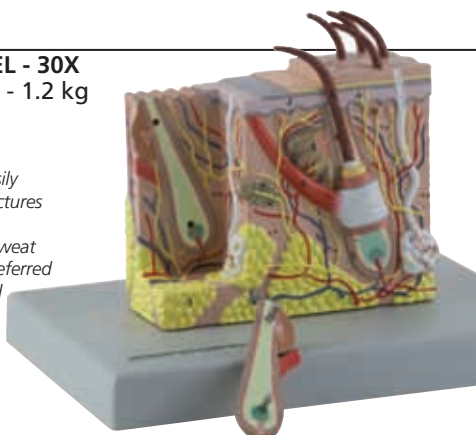

## 40060 SKIN MODEL - 70X

Size: 25x18x28 cm - 1.5 kg  
2 parts - 70X  
Mounted on base

Anatomical structures are shown in details including the hair follicles, sebaceous glands, sweat glands, erector muscles, Pacinian corpuscles, nerves and blood vessels. The different layers of the skin are clearly defined. A portion of a hair shaft can be removed to show internal details.

40060

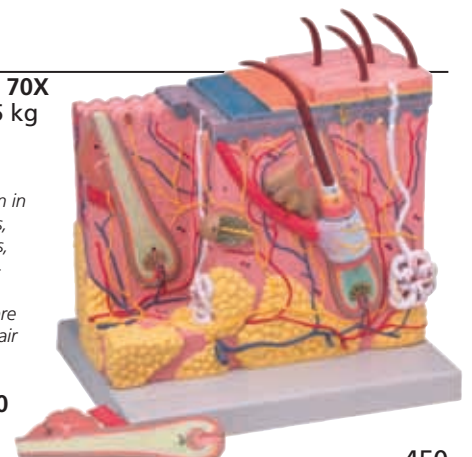

# HUMAN TORSOS WITH CD AND MUSCULAR FIGURES

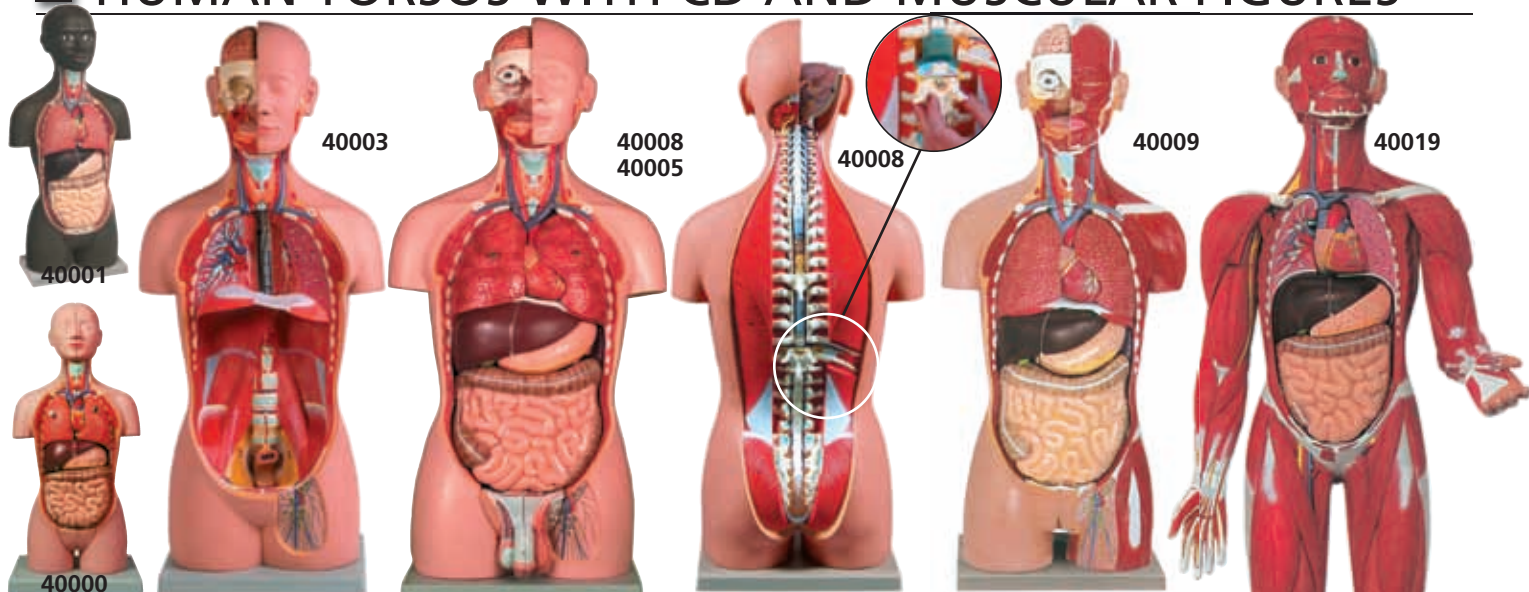

GIMA code	HUMAN TORSOS *SUPPLIED WITH CD ROM GUIDE	Size	Weight	Parts
40000	MINI TORSO	20x15xh45 cm	2.1 kg	16
40001	MINI TORSO - african	20x15xh45 cm	2.1 kg	16
40003	TORSO UNI SEX *	23x33xh90 cm	9 kg	16
40005	TORSO DUAL SEX*	23x33xh90 cm	9.3 kg	25
40008	TORSO DUAL SEX OPENBACK*	23x33xh90 cm	9.3 kg	27
40009	MUSCULAR TORSO DUAL SEX OPENBACK*	23x33xh90 cm	10 kg	28
40019	MUSCULAR FIGURE	30x33xh87 cm	5.3 kg	30



This CD-ROM Guide greatly extends the educational value of the anatomical torsos by identifying hundreds of structures that are not included on the printed key. High-resolution digital images of torso components show the finest anatomical details of all body systems from various angles.

Some of the detachable parts of human torsos (40005-8-9):



Removable structures, of codes 40005-8-9, include the following:  
 - eye with optic nerve and extraocular muscles  
 - half of the brain - trachea - descending thoracic aorta and esophagus - right and left lungs (two parts each)- liver with gallbladder - half of one kidney - two part heart - stomach dissected in two parts (not for 40005) - pancreas, duodenum and spleen - small and large intestines - male and female urogenital systems (4 parts each), (on 40009 female system is in 3 parts and provided of detachable fetus) - thoracic vertebra (T12) with spinal cord (code 40008 and 40009 only).

Detachable parts of human muscular figure 40019:



## HEAD MUSCULATURE

### • 40015 HEAD/NECK MUSCULATURE

Size: 37x23x46 cm  
 - 3.1 kg - 1 part - life size

Superficial and deep musculature are well represented as are the pathways of the subclavian and carotid arteries

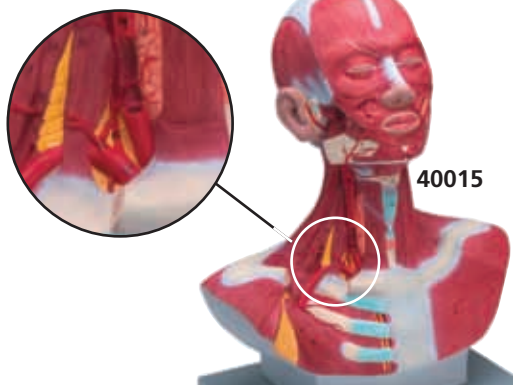

## MUSCLES: SHOULDER, ARM, LEG

### • 40016 SHOULDER MUSCLE

Size: 23x19x11 cm - 435 g  
 1 part - 1X

Mounted on a base with stand



This model illustrates in great details the muscles, ligaments and bones of the shoulder. Through different muscles section it is possible to observe the deep musculature to the bone.

### • 40017 ARM MUSCLE

Size: 74x20x12 cm - 1.9 kg  
 - 7 parts

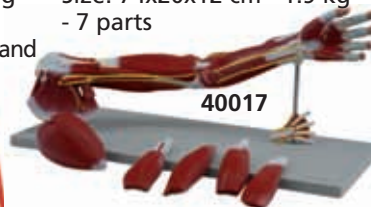

This 7-part life size model shows, in great detail, the anatomical structure of the arm, complete with superficial and deeper muscles, vascular structures, nerves and ligaments. The hand and the shoulder are also well represented. The following parts are removable:  
 - deltoid muscle  
 - biceps muscle  
 - triceps muscle  
 - long palmar muscle with radial flexor muscle of wrist  
 - brachioradial muscle  
 - radial extensor muscle of wrist  
 - palmar aponeurosis

### • 40018 LEG MUSCLE

Size: 110x19x14.5 cm - 5.1 kg  
 13 parts

Mounted on a base with stand

This 13-part model shows, in great detail, the anatomical structure of the leg, complete with superficial and deeper muscles, vascular structures, nerves and ligaments.

The following parts are removable:

- sartorius
- long head of biceps
- gluteus maximus
- soleus
- gastrocnemius
- gluteus medius
- gracilis
- semitendinosus and semimembranosus
- rectus femoris
- extensor digitorum longus
- sole of foot
- tensor fasciae latae





# SKELETONS

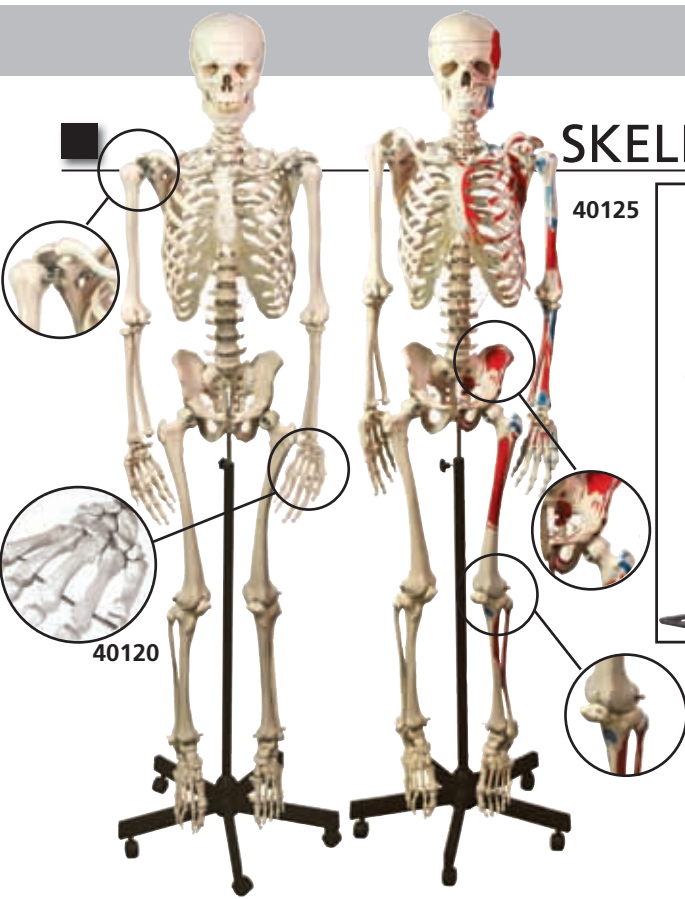

- **40115 MINI SKELETON**  
Height: 80 cm Weight: 1.5 kg. This 1/2 life size model shows the anatomy of the human skeleton in high detail. The skull can be disassembled into 3 parts: skullcap, base of skull and mandible. All the main joints are articulated. Arms and legs can be removed easily. Mounted on a stand for hanging.
- **40120 HUMAN SKELETON**  
Height: 170 cm. Weight: approx 10 kg. This model is a replica of a life size human skeleton and shows all the skeleton parts in high detail. It's hand-assembled to provide intricate details and long-lasting durability. The main joints are articulated; the upper and lower limbs can be removed easily. The following parts are detachable: Calvarium, Skull, Jaw, Arms, Legs. Supplied with 5-caster roller stand.
- **40125 MUSCULAR HUMAN SKELETON**  
Same as code 40120 but with the left side of the skeleton showing the point of origin (red) and the point of insertion (blue) of the muscles.

# VERTEBRAL COLUMNS

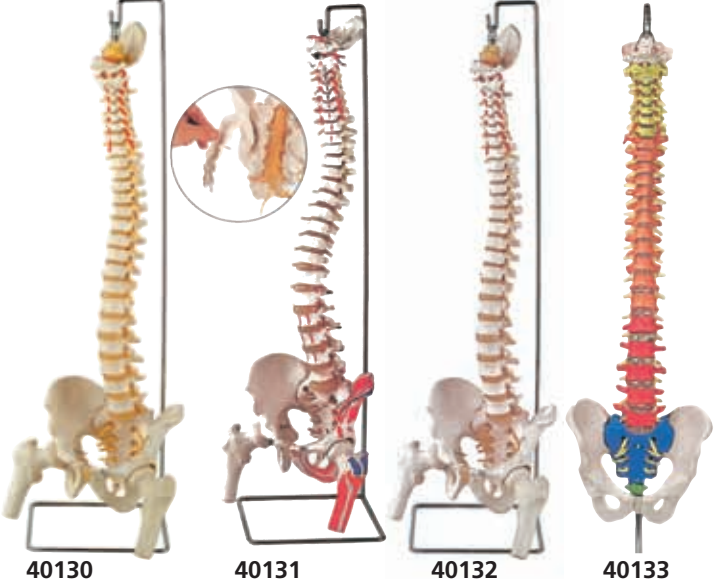

**FLEXIBLE VERTEBRAL COLUMNS**  
Fully flexible life size vertebral columns consisting of the occipital plate, cervical, thoracic and lumbar vertebrae, sacrum, coccyx, complete pelvis with symphysis, removable femur heads (only 40130,31,32). All models also feature representation of the vertebral arteries, spinal nerve branches, and a prolapsed L3-L4 intervertebral disc. On 40131 the left side of the skeleton shows the points of origin (red) and the point of insertion (blue) of the muscles. On 40131 and 40132 the sacral crest and coccyx are removable to show the sacral section of the spinal cord and associated nerve branches. On 40133 the various regions of the spinal column are colour coded for easy identification.

GIMA code	FLEXIBLE VERTEBRAL COLUMNS	Size cm	Weight	Magnif.
40130	VERTEBRAL COLUMN with femur heads	95x20x20	3 kg	1X
40131	VERTEBRAL COL with femur + muscle	95x20x20	3 kg	1X
40132	VERTEBRAL COL with femur + open sacrum	95x20x20	3 kg	1X
40133	SPINAL COL with colour coded regions	98x23x23	970 g	1X

# KNEE AND SHOULDER

- **40140 SHOULDER JOINT**  
Size: 29x12x12cm - 560g - 1 part - 1X  
Mounted on stand.
- **40145 KNEE JOINT**  
Size: 12x12x31cm - 440g - 1 part - 1X  
The life size model represents a functional model of knee joint with lateral ligaments, meniscus and patellar ligament.

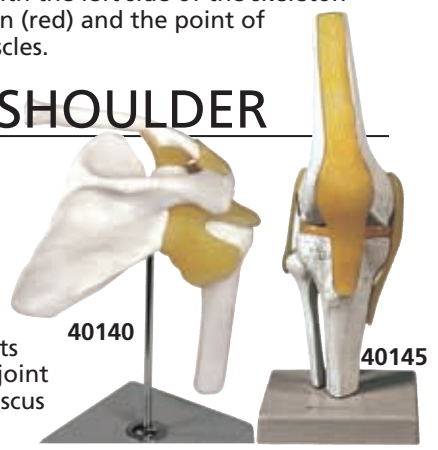

# SKELETAL SYSTEM

**Advanced osteoporosis model.**  
Shows 3 vertebrae: one healthy vertebra, one vertebra with pathological changes at first stage, one vertebra with pathological changes at advanced stage.

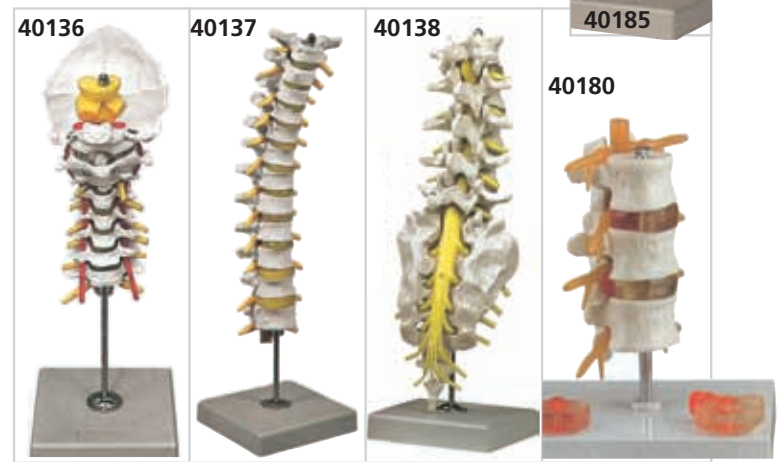

- 40136 Cervical spinal column** consists of 7 cervical vertebrae with intervertebral discs, occipital plate, cervical nerves, vertebral arteries, spinal cord and brain stem.
- 40137 Thoracic spinal column** consists of 12 thoracic vertebrae with intervertebral discs, thoracic nerves and spinal cord.
- 40138 Lumbar spinal column with sacral and coccyx bones.** It consists of 5 lumbar vertebrae with intervertebral discs, lumbar nerves and spinal cord. The sacral crest and coccyx are removable.
- 40180 3 lumbar vertebrae with hernia and prolapsed intervertebral disc.** Shows 3 lumbar vertebrae with spinal nerves, dura mater and 2 intervertebral discs affected by lateral and medial hernia.
- 40185 Advanced osteoporosis**

GIMA code	SKELETAL SYSTEM	Size cm	Weight	Magnif.
40136	CERVICAL SPINAL COLUMN	12x12x22	350 g	1X
40137	THORACIC SPINAL COLUMN	12x12x40	600 g	1X
40138	LUMBAR SPINAL COLUMN	12x12x36	800 g	1X
40180	HERNIA PATHOLOGY	16.5x12x26	300 g	1X
40185	ADVANCED OSTEOPOROSIS	12x12x15	200 g	1X

## HUMAN SKULLS - 3 PARTS

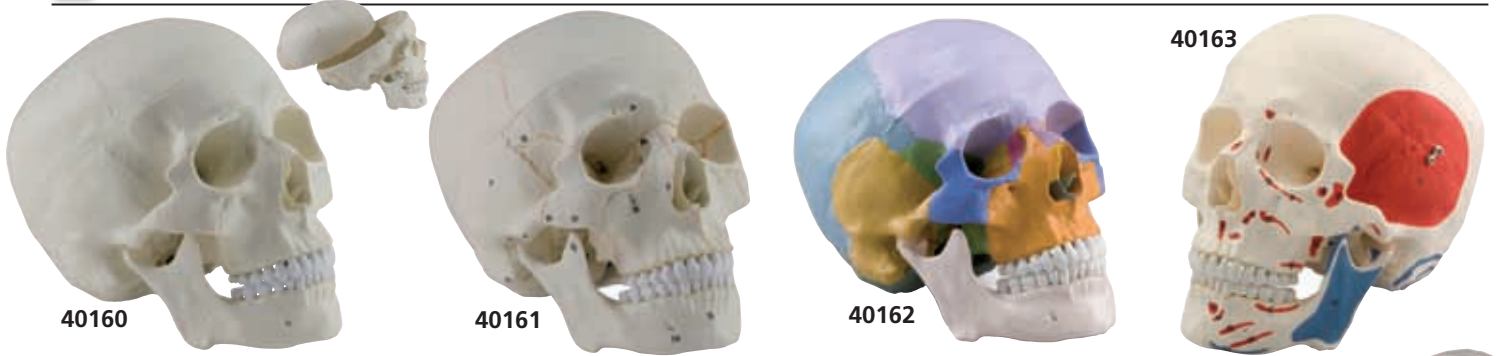

### Numbered skull (40161)

Significant structures are numerated

### Coloured skull (40162)

All the bones are depicted in different colours, making this model a useful tool to study the correct position and relationship of all the structures.

### Muscular skull (40163)

The left side of the skull shows the points of origin (red) and the point of insertion (blue) of the muscles.

### MINI SKULL (40165) ½ adult natural size

It depicts all structural details of the skull.

It can be disassembled into skullcap and base of skull.

Articulated mandible.

Life size human skull reproduction with all details, made of PVC. Removable skull cap and articulated mandible.

40165



GIMA code	HUMAN SKULLS	Size cm	Weight g	Magnif.
40160	HUMAN SKULL	22x14x16	950	1X
40161	HUMAN SKULL - numerated	22x14x16	950	1X
40162	HUMAN SKULL - coloured	19.5x17x21.5	950	1X
40163	HUMAN SKULL - muscular	18x17x21	875	1X
40165	MINI SKULL	11x11x16.5	150	0.5X

## DENTAL MODELS

### • 40206 DECIDUOUS TEETH

Size: 9x9x10 cm - weight: 85 g. Mounted on base with stand.

This life size model shows the upper and lower jaw of a 5 year old child. The lower jaw is movable to reproduce the natural chew. The model exposes the arrangement of the young teeth.

### • 40205 PERMANENT TEETH

Size: 11x11x12 cm - weight: 170 g. Mounted on base with stand.

This life size model shows the upper and lower jaw of an adult. The lower jaw is movable to reproduce the natural chew. The model exposes the complete set of permanent teeth with roots and nerves fibres.



### • 40210 LOWER JAW

Size: 35x18x31 cm - weight: 1130 g

Mounted on base with stand.

This 3X life size model is divisible into 6 parts to show all the characteristics of an adult half mandible. A portion of the jaw can be removed to show the roots of the teeth and the internal structure of the bone. Canine and molar teeth can be removed and dissected longitudinally to observe the tooth roots, pulp and nerves.



### • 40212 DENTAL PATHOLOGY MODEL

Size: 6x4.5x11 cm - weight: approx. 100 g

This 4X life size model shows the process of dental caries in its progressive stages.

The tissues forming the tooth (enamel, dentine and pulp) are shown, along with the way in which they are affected by the caries process.

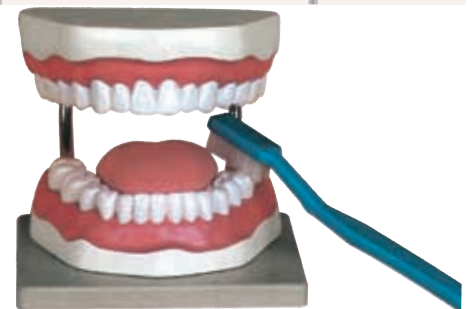

### • 40200 ORAL HYGIENE

Size: 12x16x22 cm - weight: 1 kg

Mounted on base.

A 3X life size model useful to teach the correct way to brush teeth. A giant toothbrush is included.



### • 40213 SET 3 TEETH: INCISOR, CANINE, MOLAR

Size: 33x33x11 cm -

weight: 700 g

5-part model includes representations (10X life size) of human incisor, canine and molar teeth. The canine and molar can be divided into 2 parts each, showing internal features (dentine, enamel, cement and pulp).



### • 40214 LOWER MOLAR WITH CARIES

Size: 11x11x19.5 cm - weight: approx. 250 g

Mounted on base with stand.

This 1-piece model is approximately 10X life size; it shows the most important dental pathologies, including dental caries, pulpitis, gingivitis and periapical periodontitis.



### • 40211 DENTAL CARIES

Size: 12x6x6 cm -

weight: approx. 300 g

This model, composed of 7 parts, is 4X life size. It consists of 3 teeth, seated in their sockets, showing the progressive deterioration of tooth structure by dental caries. The first tooth shows the caries in the enamel. In the second tooth, the caries spreads through the dentine. In the third tooth, the pathology affects the pulp, jeopardizing the vitality of the tooth.

# VALUE HUMAN ANATOMY MODELS

**HUMAN SKULLS - 3 parts**

A detailed reproduction of a life size human skull with all structural details. The mandible is articulated, the skullcap is removable to show internal details. All of the joints, sutures, fissures, foramina and processes are portrayed with utmost accuracy.



• 40155 HUMAN SKULL 1X - 3 parts - 21.5x12x16.5 cm



• 40156 HUMAN SKULL 1X NUMERATED - 3 parts



• 40157 HUMAN SKULL 1X COLOURED - 3 parts



Giant toothbrush is included

• 40199 ORAL HYGIENE MODEL - 3X

Fully flexible life size vertebral columns consisting of the occipital plate, cervical, thoracic and lumbar vertebrae, sacrum, coccyx, complete pelvis with symphysis, removable femur heads



• 40127 FLEXIBLE VERTEBRAL COLUMN with femur heads



A functional model of knee joint with lateral ligaments, meniscus and patellar ligament.

• 40144 KNEE JOINT



40119

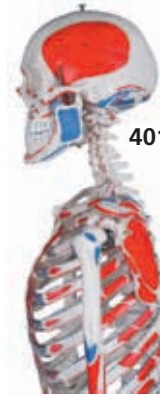

40124

Life size human skeletons show all the skeleton parts in high detail. The main joints are articulated; the upper and lower limbs can be easily removed. The following parts are detachable: Calvarium, Skull, Jaw, Arms, Legs. Supplied with 5-caster roller stand.

Height: 180 cm  
Weight: approx 10 kg



40124

• 40119 HUMAN SKELETON

• 40124 HUMAN MUSCULAR SKELETON



• 40139 SHOULDER JOINT

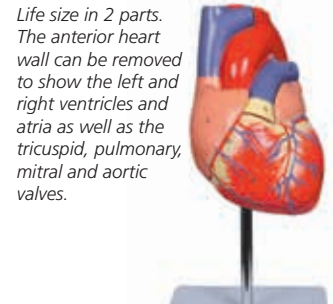

• 40069 HEART 1X - 2 parts

Life size in 2 parts. The anterior heart wall can be removed to show the left and right ventricles and atria as well as the tricuspid, pulmonary, mitral and aortic valves.



Assembled

• 40028 EYE 6X - 6 parts



40028

Disassembled

Cornea, iris, lens and vitreous body can be removed.



• 40070 HEART 3X - 3 parts



40070

Shows internal structures including the cardiac valves and the comparative morphology of the right and left ventricles.



• 40038 EAR 3X - 3 parts

These models show the external, middle and inner ear. The eardrum with malleus, incus and stapes are removable. Also cochlea and labyrinth with vestibular and cochlear nerves and 2 bones sections (40039 only) that define the middle and inner ear are removable. Size: 32x20x21 cm Packaging size: 34.5.22x23.5 cm Packaging weight: 1.7 kg



• 40039 EAR 3X - 5 parts

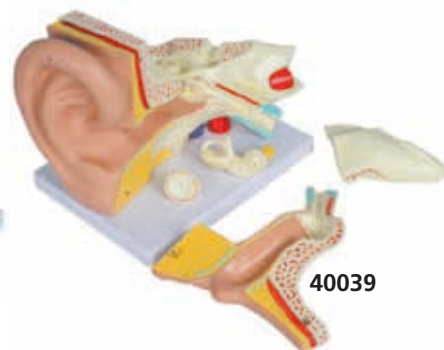

40039



GIMA GLUCOSE MONITOR KIT page 1



QV-500 PROFESSIONAL VEIN FINDER page 75



SURGICAL SUTURE STERILE page 55-57



TERUMO® NEEDLES AND SYRINGES page 70



ELECTRIC WHEELCHAIR page 125



ELECTRIC PATIENT BED page 136



MPR HOSPI PLUS ASPIRATOR page 206



RCS-100 RIESTER CAMERA SYSTEM page 253



LITTMANN® CORE STETHO page 287



3 IN 1 ULTRASOUND SCANNER page 344



i-PAD CU SPR DEFIBRILLATOR page 356



PEHA-HAFT® ELASTIC COHESIVE BANDAGES page 404



# GIMA

GIMA S.p.A. - Via Marconi, 1 - 20060 Gessate (MI) - Italy  
e-mail: [export@gimaitaly.com](mailto:export@gimaitaly.com) [www.gimaitaly.com](http://www.gimaitaly.com)